

CALIFORNIA REGIONAL WATER QUALITY CONTROL BOARD
CENTRAL VALLEY REGION

ORDER R5-2015-0084

WASTE DISCHARGE REQUIREMENTS

FOR
SACRAMENTO RENDERING COMPANIES
SACRAMENTO RENDERING COMPANIES RANCHO CORDOVA RENDERING PLANT
SACRAMENTO COUNTY

The California Regional Water Quality Control Regional Board, Central Valley Region, (hereafter Central Valley Water Board) finds that:

1. On 30 November 2007, Sacramento Rendering Companies (SRC) submitted a Report of Waste Discharge (RWD) that describes the discharge of animal rendering process wastewater at their Rancho Cordova Rendering Plant. Additional information to update and complete the RWD included the Land Application Assessment Report dated March 2007, Land Application Assessment Addendum Report dated 30 June 2008, and various monitoring reports submitted between 2010 through 2013.
2. Sacramento Rendering Companies (hereafter "Discharger") owns and operates the Rancho Cordova Rendering Plant that generates the animal rendering process wastewater and the land to which the waste is discharged, and is responsible for compliance with these Waste Discharge Requirements (WDRs).
3. The facility is at 11350 Kiefer Boulevard in Rancho Cordova (Section 24 and 25, T8N, R6E and Section 30, T8N, R7E, MDB&M). The facility occupies Assessor's Parcel Numbers (APN) 067-0090-005-0000, 067-0090-019-000, 067-0050-048-0000, 067-0090-021-0000, and 067-0090-002-0000, as shown on Attachment A, which is attached hereto and made part of this Order by reference.
4. WDRs Order R5-2005-0166, adopted by the Central Valley Water Board on 29 November 2005, prescribes requirements for the discharge. Order R5-2005-0166 allows a monthly average wastewater flow up to 150,000 gallons per day (gpd) and established the following interim effluent limitations:

Constituent	Units	Monthly Average Concentration
Total Dissolved Solids	mg/L	2,000
Total Nitrogen	mg/L	750

5. Companion Cease and Desist Order (CDO) R5-2005-0167 was adopted on the same day and required the Discharger to perform various tasks and comply with a time schedule to implement measures and improvements required to ensure compliance with Order R5-2005-0166. Specifically, the CDO required the following:

- a. Additional treatment or control to support an exemption from Title 27 for the wastewater ponds;
- b. Facility and/or operational improvements to reduce nitrogen loading to the land application areas; and
- c. Facility and/or operational improvements to prevent the release of waste constituents to surface waters via runoff from the LAAs.

CDO R5-2005-0167 was rescinded on 10 October 2014 because the Discharger completed the required studies and certain facility and operational improvements, and submitted a new RWD as required.

- 6. Because of the improvements, the WDRs are no longer adequate to regulate the discharge. It is appropriate that WDRs Order R5-2005-0166 be rescinded and replaced with this Order.

Existing Facility and Discharge

- 7. The rendering plant processes livestock carcasses, meat and poultry processing by-products, and grease from restaurants and other food services businesses. The facility has been operating at this site since 1956.
- 8. The facility is supplied with water from three onsite wells designated as Production Well 1, 2, and 3. Production Wells 1 and 2 provide supplemental irrigation water for the process wastewater land application areas (LAAs). Production Well 3 supplies approximately 64,000 gpd of water for the rendering process. Well locations are shown on Attachment B, which is attached hereto and made part of this Order by reference.
- 9. Based on samples collected on 11 November 2004 from Production Well 3, source water quality for select constituents is presented in the table below.

Parameter	Source Water Quality, mg/L unless specified
TDS	160
pH, std units	7.61
Total Hardness	60
Chloride	7.9
Sodium	20
Sulfate	2.4
Potassium	2.3
Magnesium	6.8
Nitrate (NO ₃)	4.1

10. Approximately 750,000 pounds per day of animal by-products is processed. The rendering process typically operates 24 hours per day, seven days per week. The material is first crushed and then cooked to evaporate moisture. The material is then screened and passed through a screw press to separate fat from the protein solids. The protein solids are ground to create protein meal product, and the fat is centrifuged and then pumped to outdoor storage tanks.
11. Tanker trucks deliver grease from restaurants and other food service businesses. Water is separated from the grease and the grease is then processed in the same cookers used to render meat by-products.
12. Vapor from the cookers flows through an air-cooled condenser. Air leaving the condenser is treated to remove odor-producing compounds using a Venturi scrubber and a thermal oxidizer. Additionally, Scrubbers 1 through 4 treat air exhausted from the plant building to reduce objectionable odors.

Hydrochloric acid and sodium hypochlorite (approximately 750 pounds per month) are used to generate chlorine dioxide, which is then added to the air scrubber water supply to oxidize organic compounds. Approximately 2,500 pounds of sodium chloride is used each month to regenerate the ion exchange system that produces softened water for the boiler.

13. Wastewater generated by the rendering plant consists of moisture from animal by-products, water separated from grease, condensate from the continuous cookers, contact water from the Venturi scrubber and Scrubbers 1 through 4, plant sanitation wastewater, water softener reject, boiler blowdown, and incidental storm water runoff from some roof drains and the exterior part of the processing plant's front loading area.
14. The character for each waste stream is presented in the table below.

Location Description	Concentration ¹ , mg/L unless specified							
	BOD	TDS	FDS	TKN	Ammonia Nitrogen	Nitrate as NO ₃	Sodium	Chloride
Cooker Condensate	3,600	300	260	1,800	1,500	<2	2	28
Trap Water	15,000	4,000	1,900	610	330	<2	340	380
Scrubber 1 Water	390	910	780	77	65	3	270	390
Scrubber 2 Water	390	700	600	72	57	2	190	350
Scrubber 3 Water	360	300	240	65	37	4	42	59
Scrubber 4 Water	690	4,700	2,800	1,200	1,100	61	560	1,300
Venturi Scrubber Water	3,000	200	140	230	200	4	18	11
Sanitation Water – Back Processing	17,400	5,800	3,000	510	130	<10	570	870
Blood/Liquids	17,400	28,000	7,700	5,000	2,200	<10	620	2,500
Boiler Water Blowdown	<3	110	85	0	<0.1	<2	1	4

Location Description	Concentration ¹ , mg/L unless specified							
	BOD	TDS	FDS	TKN	Ammonia Nitrogen	Nitrate as NO ₃	Sodium	Chloride
Hot Dip Water	3,200	4,500	1,800	27	5	9	760	65
Outdoor Tank Water	1,900	350	110	6	1	<2	11	11
Water Softener Reject	<3	170	160	1	0	2	290	7,700

¹ Based on samples obtained on 14 Sep 2006, with the exception of the water softener reject sampled on 5 Oct 2006.

15. Daily wastewater flows are variable, ranging from 70,000 to over 100,000 gpd. The combined wastewater stream from all sources contains high concentrations of biochemical oxygen demand (BOD), total dissolved solids (TDS), and nitrogen (primarily in the form of ammonia).
16. The process wastewater undergoes treatment, is stored in unlined ponds, and is then used to irrigate land application areas (LAAs) that serve as pasture, as described below.
17. Process wastewater undergoes a pretreatment process to remove excess oil and grease that includes an equalization tank, a pre-skimmer unit, and a dissolved air flotation (DAF) unit. A process flow diagram of the treatment and disposal system that includes the various waste streams and routing is provided in Attachments D and E, which is attached hereto and made part of this Order by reference.

DAF effluent undergoes anaerobic treatment in eight unlined small and shallow lagoons referred to as the Finger Lagoons, which operate in series. The lagoons have a total capacity of 1.1 acre-feet with two feet of freeboard and are approximately four feet deep. The following table presents average influent flow rates (daily flows from the DAF unit to the Finger Lagoons) obtained from the Annual Reports.

Flow Parameter	Flow Rate, gallons per day
2004 ¹	81,000
2005	93,000
2006	103,000
2007	95,000
2008	96,000
2009	95,000
2010	110,000
2011	110,000

Flow Parameter	Flow Rate, gallons per day
2012	119,000
2013	119,000

¹ Average monthly flow for 2004 was calculated from April through December, as data from January through March were unavailable.

18. During the wet-weather months (mid-October through mid-April), effluent from the Finger Lagoons is sent to the unlined Front Winter Storage Pond, and any excess is directed to the unlined Back Winter Storage Pond. The Front Winter Storage Pond has existed since 1956. The Back Winter Storage Pond was constructed in 2004 to provide additional storage capacity and capture tailwater and first flush storm water from the southernmost LAAs. Pond storage capacity is presented below.

Parameter	Front Winter Storage Pond	Back Winter Storage Pond
Surface area (acres)	2.9	11
Depth w/ 2-foot freeboard (feet)	19	5
Volume w/ 2-foot freeboard (acre-feet)	40	32

19. During the dry weather months (April through September), the unlined Back Mixing Pond receives wastewater from the Finger Lagoons, water that has accumulated in the Winter Storage Ponds, and any tailwater runoff from the southernmost LAAs. During the wet weather months, the Back Mixing Pond receives first flush storm water from the southernmost LAAs. Wastewater from the Back Mixing Pond is used to irrigate the back pasture (LAAs 3, 4, 5, and 6). Fresh water from the irrigation supply wells can be pumped to the Back Mixing Pond. The ratio of wastewater to supplemental water in the mixing pond varies from 1:1 to 1:2 during the dry weather months. Pond storage capacity is presented below.

Parameter	Back Mixing Pond
Surface area (acres)	3.0
Depth w/ 2-foot freeboard (feet)	8.0
Volume w/ 2-foot freeboard (acre-feet)	13

20. During the dry weather months, the unlined Front Mixing Pond receives wastewater from the Back Mixing Pond and any tailwater runoff from the front pasture (LAAs 1 and 2). Wastewater from the Front Mixing Pond is used to irrigate the front pasture. Fresh water from the irrigation supply wells can be pumped to the Front Mixing Pond. The ratio of wastewater to supplemental water in the mixing pond varies from 1:1 to 1:2 during the dry weather months of April through September. Pond storage capacity is presented below.

Parameter	Front Mixing Pond
Surface area (acres)	0.6
Depth w/ 2-foot freeboard (feet)	11
Volume w/ 2-foot freeboard (acre-feet)	4.0

21. Treated wastewater is applied to the LAAs, which consist of six fields of pasture totaling approximately 85 acres by flood irrigation. Cattle and sheep are allowed to graze the LAAs. Supplemental irrigation water is periodically applied directly to the fields to dilute dissolved solids and other constituents in the wastewater and supplement the water demand of grass in the fields. In 2013, supplemental water was directly applied to three of the six fields and only during the months of November and December. The locations of the LAAs are presented on Attachment B. A summary of the LAAs is presented below:

Land Application Areas	Acres
Front Pasture Areas	
Field 1	3.9
Field 2	8.9
Back Pasture Areas	
Field 3	20.8
Field 4	22.8
Field 5	18.4
Field 6	10.3
Total LAA Acreage:	85.1

Changes to Facility and Discharge

22. In response to CDO R5-2005-0167, the Discharger evaluated additional treatment and source control measures. Since February 2009, the following improvements have been made:
- a. Construction of an additional land application area (Field 6) to reduce mass loading of nitrogen on a per acre basis.
 - b. Construction of blood/liquid handling facilities that divert salts contained in the blood and liquids into products instead of wastewater.
 - c. Segregation and off-site disposal of boiler blowdown and water softener reject water at a permitted facility.
 - d. Implementation of a field flushing program with supplemental irrigation water prior to the start of the rainy season, to improve the quality of storm water runoff

discharged to Frye Creek. Tailwater generated during the flushing operation is collected in the winter storage ponds.

- e. Following each grazing rotation, use of a tractor-mounted chain or spike drag pulled across the field to break up manure into smaller particles. Reduction in particle size increases the potential for additional nitrogen loss through ammonia volatilization and improves the subsequent leaching and decomposition of organic matter and nutrients in the soil.
- f. Protection of all tailwater and storm water collection trenches, pipe entrances, valves, and other tailwater and storm water conveyances from cattle intrusions; and repair as necessary to minimize erosion and impacts from cattle wastes.

23. The process wastewater now consists of moisture from animal by-products, water separated from grease, condensate from the cookers, contact water from the Venturi scrubber and Scrubbers 1 through 4, plant sanitation wastewater, and storm water runoff from some of the roof drains and exterior part of the processing plant's front loading area.

24. Wastewater quality at this facility has improved since implementation of the source control measures described above. Influent and effluent quality is presented in the table below. Finger Lagoon influent is measured as the DAF effluent.

Constituents	Potential Water Quality Objective	Finger Lagoon Wastewater Quality, mg/L unless specified		
		Influent		Effluent
		2004 ¹ Range (Pre-Improvements)	2009 - 2013 ² Average (Post-Improvements)	2009 – 2013 ² Average
BOD	--	2,300 – 11,000	2,800	1,800
TDS	450 ⁶ - 1,000 ⁴	960 – 3,100	620	525
FDS	--	40 - 370	370	390 ⁷
TKN	--	430 – 1,200	300	295
Nitrate nitrogen	10 ⁵	< 1.0	0.7	0.8
Ammonia nitrogen	--	230 - 990	330	320
Sodium	69 ⁶	170 - 250	80	90
Chloride	106 ⁶ - 500 ⁴	220 - 260	65	80

¹ Per WDRs R5-2005-0166, range of data based on 3 sampling events in November 2004.

² Average based on monitoring data from Feb 2009 – Dec 2013.

³ Recommended Secondary Maximum Contaminant Level.

⁴ Upper Secondary Maximum Contaminant Level.

⁵ Primary Maximum Contaminant Level.

⁶ Agricultural Water Quality Goal.

⁷ Flow-weighted annual average FDS based on 2013 data.

25. WDRs Order R5-2005-0166 requires that the total nitrogen loading to each LAA irrigation check not exceed the agronomic rate for plant available nitrogen (PAN) for the type of crop grown. In compliance with CDO Order R5-2005-0167, the Discharger provided a method of calculating PAN based on waste character and site-specific physical and climatic conditions. Despite improvements to the LAA operations, loading rate data presented below show that total nitrogen loading rates have occasionally exceeded agronomic rates for PAN at some of the LAAs in violation of the WDRs.

	2010 – 2013 Loading Rates, lb/ac/yr												Crop Uptake for Grasses ² (lb/ac/yr)
	Field 1		Field 2		Field 3		Field 4		Field 5		Field 6 ¹		
	TN	PAN	TN	PAN	TN	PAN	TN	PAN	TN	PAN	TN	PAN	
2010	450	170	370	140	1,400	550	660	250	710	280	680	230	370 - 418
2011	660	230	620	220	1,400	520	1,100	380	1,300	490	1,150	390	370 - 418
2012	440	160	350	130	1,060	390	810	290	830	300	700	240	370 - 418
2013	440	160	300	150	1,090	420	990	370	1,170	440	940	360	370 - 418

TN denotes total nitrogen.

¹ Discharger began using Field 6 in the spring 2010.

² Per *Land Application Assessment Study*, March 2007.

26. Irrigation cycle average BOD loading rates at the LAAs during the 2013 irrigation season ranged from 1 to 70 lb/ac/day and varied between LAA fields, as summarized in the following table.

	2013 Cycle Average BOD Loading Rate ¹ , lb/ac/day					
	Field 1	Field 2	Field 3	Field 4	Field 5	Field 6
Average	4.4	5.6	13	12	12	19
Minimum	1.0	1.0	1.0	2.2	1.5	1.0
Maximum	10	20	40	20	20	70

¹ LAA fields were irrigated during the months of April through October 2013.

Typically, irrigation with high strength wastewater results in high BOD loading on the day of application. It is reasonable to expect some oxidation of BOD at the ground surface, within the evapotranspiration zone and below the root zone within the vadose (unsaturated) zone. The maximum BOD loading rate that can be applied to land without creating nuisance conditions or leaching of metals into underlying groundwater can vary significantly depending on soil conditions and operation of the land application system. The California League of Food Processors' *Manual of Good Practice for Land Application of Food Processing/Rinse Water* proposes risk categories associated with particular BOD loading rate ranges as follows:

- a. Risk Category 1: (less than 50 lb/ac/day as an irrigation cycle average; depth to groundwater greater than 5 feet) Indistinguishable from good farming operations with good distribution important.

- b. Risk Category 2: (less than 100 lb/ac/day as an irrigation cycle average; depth to groundwater greater than 5 feet) Minimal risk of unreasonable groundwater degradation with good distribution more important.
- c. Risk Category 3: (greater than 100 lb/ac/day as an irrigation cycle average; depth to groundwater greater than 2 feet) Requires detailed planning and good operation with good distribution very important to prevent unreasonable degradation, as well as use of oxygen transfer design equations that consider site-specific application cycles and soil properties and special monitoring.

The *Manual of Good Practice* recommends allowing a 50 percent increase in the BOD loading rates in cases where sprinkler irrigation is used, but recommends that additional safety factors be used for sites with heavy and/or compacted soils.

27. Although it has not been subject to a scientific peer review process, the *Manual of Good Practice* provides science-based guidance for BOD loading rates that, if fully implemented, are considered a best management practice to prevent groundwater degradation due to reduced metals.

Based on facility and site-specific information, the discharge falls in Risk Category 2.

28. Storm water monitoring was established to determine whether the Discharger's current LAA storm water retention program and storm water best management practices were adequate to protect surface water quality during the entire rainy season. Currently, storm water runoff generated during the first significant rainfall event is directed to the Winter Storage Ponds. In an effort to improve storm water runoff quality, the Discharger has implemented the following Best Management Practices (BMPs):
- a. Implementation of a field flushing program each fall with groundwater prior to discharging storm water to Frye Creek, as discussed further below.
 - b. Following each grazing rotation, a tractor-mounted chain or spike drag is pulled across the field to break up manure into smaller particles. Reductions in particle size should increase the potential for additional nitrogen loss through ammonia volatilization and should improve the subsequent leaching and decomposition of organic matter and nutrients in the soil.
 - c. All tailwater and storm water collection trenches, pipe entrances, valves, and other tailwater and storm water conveyances are protected from cattle intrusion, and when necessary, such conveyances are repaired to minimize erosion and impacts from cattle wastes.
29. Storm water from outdoor areas of the plant and some of the building roof drains is collected into a subsurface storm drain system that discharges to Frye Creek, an intermittent tributary of Laguna Creek. The discharge location is shown as Outfall OpA on Attachment C. Prior to 2006, storm water runoff from LAA Field 1

and 2 was conveyed by the same drainage system to Outfall OpA and tailwater from Field 1 and 2 was conveyed to the Front Mixing Pond for recycling. The back pasture areas drain both tailwater and storm water to the Back Mixing Pond, which is used to recycle tailwater and capture the first flush of storm water from those fields.

Prior to 2004, the Front and Back Mixing Ponds captured all storm water flows from the LAAs and were allowed to overflow into Frye Creek. The Discharger purportedly was diluting wastewater with fresh water at a ratio of 20 to 1 for irrigation and cleaning out the Back Mixing Pond prior to the rainy season each year; therefore, such releases were not specifically prohibited by the previous Order. The Back Mixing Pond outfall at Frye Creek is shown as Outfall BP on Attachment B.

30. Prior to the 2006 and 2007 rainy season, SRC eliminated storm water discharges from LAA Fields 1 and 2 through Outfall OpA. Currently, storm water runoff from LAA Fields 1 and 2 discharges into an on-site depression, which is pumped onto LAA Field 3. Storm water runoff from LAA Field 3 discharges onto LAA Field 4 through a free-flowing outfall. Storm water runoff from LAA Field 4 accumulates at the base of Field 4 prior to discharging through Outfall BP. Storm water runoff from LAA Field 5 accumulates at the base of Field 5 prior to discharging through Outfall BP. Storm water runoff from LAA Field 6 drains onto LAA Field 5 prior to discharging through Outfall BP. Storm water from the industrial area of the plant discharges to Outfall OpA.
31. Storm water monitoring data from the 2009-13 rainy seasons is summarized in the table below. Storm water sampling locations are shown on Attachment C, which is attached hereto and made part of the Order by reference.

Location	Average Storm Water "First Flush" Quality, mg/L unless specified									
	BOD	TDS	TKN	Ammonia nitrogen	Nitrate nitrogen	Chloride	Fe	Mn	Na	Sulfate
Background ¹	NA	160	4.8	0.7	NA	30	1.0	0.1	10	10
Field 1-2 ²	20	310	5.3	1.4	4.7	60	0.6	2.3	20	10
Field 3 ²	10	280	5.5	1.2	7.9	30	1.2	1.2	20	5.2
Field 4 ²	20	230	5.0	0.9	5.0	10	0.7	0.2	20	4.8
Field 5 ²	20	240	5.7	3.3	2.7	20	0.5	0.1	20	5.6
Field 6 ²	10	190	3.3	0.7	5.2	20	0.3	0.1	20	5.9
Outfall BP ²	10	210	4.6	1.0	1.3	10	0.7	0.0	20	4.2
Frye Creek Downgradient ³	10	220	5.9	1.4	1.4	30	0.8	0.1	20	3.3
Frye Creek Upgradient ⁴	5	120	1.1	0.3	3.1	4.5	1.1	2.1	6.5	5.2

"—" denotes data not available. Fe denotes iron. Mn denotes manganese. Na denotes sodium, NA denotes not applicable; a statistical method could not be used to calculate representative background concentrations for a select constituent because the majority of the concentrations were below detection limits.

¹ Based on four permanent background locations sampled during the 2005-2006 rainy season, as shown on Attachment C. For the 2006-2007 Storm Water Monitoring Report, all background data were grouped to determine a tolerance interval at the 95 percent upper confidence level for each constituent. The Discharger has not sampled the background locations since then.

² Sample locations for storm water discharging from the LAAs. All LAAs drain to Outfall BP.

- ³ Sample location for storm water in Frye Creek downgradient of SRC's facility and Outfall BP.
⁴ Sample location for storm water in Frye Creek upgradient of SRC's facility and Outfall OpA.

In general, storm water runoff from the LAAs contains some constituents (particularly salinity constituents and nutrients) at concentrations greater than background concentrations measured in unirrigated, adjacent land and storm water quality in Frye Creek upgradient of the facility in violation of the WDRs. Continued monitoring of the LAA storm water retention program is necessary to determine whether current operational practices are sufficient or whether additional flushing of the LAAs and/or cessation of waste discharge to the LAAs earlier than 15 October each year is appropriate.

32. The 2007 RWD did not include a water balance. The Discharger has not indicated that the wastewater flow will increase. Monthly monitoring reports do not indicate any storage and disposal capacity issues. Based on the water balance submitted in 2005 for preparation of WDRs R5-2005-0106, the facility has adequate wastewater and storm water storage capacity to accommodate an average daily flow of 150,000 gallons. However, major structural and operational changes were implemented after that time. This Order continues the previous flow limit but requires that the Discharger submit an updated water balance to verify sufficient capacity while ensuring an appropriate level of LAA runoff retention at the beginning of each rainy season.

Site-Specific Conditions

33. The rendering plant area is relatively level, and the irrigated pasture areas are gently sloped at an elevation of approximately 145 feet above mean sea level (MSL).
34. Frye Creek originates immediately west of the back pasture area and drains to the southwest. The creek is an ephemeral stream that collects storm water runoff from the property during the wet weather months. The Federal Emergency Management Agency does not identify Frye Creek as a flood hazard and the facility is not constructed within a 100-year flood zone.

The County of Sacramento Municipal Services Agency, Department of Water Resources identified the facility to be within a Local Flood Hazard Area. It appears that the designation was made without a formal hydrologic study. Local Flood Hazard Area designations are locations where standing water has been observed or reports of flooding have been submitted to the County.

35. Surrounding land uses have been historically rural and agricultural. However, the area is undergoing urban development and residential developments now neighbor the facility. Annual precipitation in the vicinity averages approximately 23.5 inches, the 100-year total annual precipitation is approximately 42.5 inches, and the reference evapotranspiration rate is approximately 57 inches per year.

Groundwater Conditions

36. Subsurface soils at the site are interbedded layers of clay, silt, sand, and gravel. According to the Web Soil Survey published by the United States Department of Agricultural Natural Resources Conservation Service, the site is located in an area where there are three predominant soil series: Red Bluff, Redding, and Fiddyment.
- a. The Red Bluff soil series consists of loam, clay loam, and gravelly clay loam with a moderately high saturated hydraulic conductivity (0.20 to 0.57 in/hr). The Red Bluff soil series are mainly north of the Finger Lagoons, Field 1, and the northern section of Field 2.
 - b. The Redding soil series consists of gravelly loam and gravelly clay loam with a very low saturated hydraulic conductivity (0.0 in/hr). The Redding soil series are mainly at the treatment facility site (Finger Lagoons, Front Winter Storage, and Front Mixing Pond), within the southern portion of Field 2, Field 3, and the northern portion of Field 4.
 - c. Fiddyment soil series consists of fine sandy loam, sandy clay loam, and weathered bedrock with a very low saturated hydraulic conductivity (0.0 in/hr). The Fiddyment soil series are mainly at the Back Winter Storage Pond 1, the southern portion of Field 4, Field 5, and Field 6.
37. Groundwater is generally encountered at approximately 140 feet below the ground surface (5 feet above mean sea level) and generally flows west to southwest.
38. Nine groundwater monitoring wells (MW-2 through MW-10) monitor first encountered groundwater quality. MW-1 was destroyed on August 2005. The wells have been monitored since their installation. MW-8 and MW-9 are consistently upgradient of the treatment facility, unlined ponds, and LAAs, and are therefore considered representative of background groundwater quality. The monitoring well locations are shown on Attachment B. Well construction details are presented below.

Well ID	Location	Well Completion Date	Top of Casing Elevation (ft MSL)	Total Well Depth (ft bgs)
MW-2	Southeast of the Finger Lagoons	12/5/02	151	160
MW-3	North of the treatment facility	12/9/02	152	160
MW-4	East of the Finger Lagoons	3/15/04	153	170
MW-5	Northwest of the Winter Storage Pond	7/29/05	142	166
MW-6	Within Field 3	7/29/05	149	168

Well ID	Location	Well Completion Date	Top of Casing Elevation (ft MSL)	Total Well Depth (ft bgs)
MW-7	West of the Winter Storage Pond	6/28/06	139	165
MW-8	Northeast of Field 2	9/27/06	157	179
MW-9	East of Field 5, along facility boundary limits	6/30/06	146	165
MW-10	Within Field 2	4/4/07	157	172

MSL denotes mean sea level. bgs denotes below ground surface.

39. Groundwater monitoring data from 2009 through 2013 is presented in the table below for select constituents. The Discharger's monitoring reports show that groundwater samples were not collected from MW-2 and MW-3 beginning in September 2011 due to the wells being dry after purging. Groundwater samples were collected during two sampling events in 2012 and no samples were collected in 2013.

Constituent	Potential WQG, mg/L	Average Concentrations in Shallow Groundwater ¹ , mg/L								
		Upgradient		Downgradient						
		MW8	MW9	MW2	MW3	MW4	MW5	MW6	MW7	MW10
TDS	450 ⁵ - 1,000 ³	160	150	280	180	580	340	170	160	160
FDS	--	140	120	210	140	420	200	140	130	130
Ammonia N	--	0.1 ⁶	0.2 ⁷	0.1 ⁷	0.1 ⁶	0.1 ⁷	0.1 ⁷	0.1 ⁷	0.2 ⁷	0.1 ⁶
Nitrate N	10 ⁴	1.6	0.6	3.7	1.7	5.3	2.8	2.2	1.5	1.5
Sodium	69 ⁵	15	15	25	20	40	25	15	20	15
Chloride	106 ⁵ - 500 ³	8.5	7.3	45	7.6	125	85	17	15	15

¹ Average based on monitoring data from 2009 – 2013.
² Recommended Secondary Maximum Contaminant Level.
³ Upper Secondary Maximum Contaminant Level.
⁴ Primary Maximum Contaminant Level.
⁵ Agricultural Water Quality Goal.
⁶ Monitoring results were non detect, value represents reporting limit.
⁷ Majority of the monitoring results were non-detect, value represents the average non-detect data points.

40. Based on an inter-well analysis, monitoring data from MW-2, MW-4, and MW-5 show that the unlined storage ponds (particularly the Front Winter Storage Pond, Finger Lagoons, and Back Mixing Pond) have caused some degradation of the underlying groundwater with respect to TDS, chloride, and nitrate; but have not caused an exceedance of a water quality objective. MW-4 TDS concentrations are above the recommended secondary MCL of 500 mg/L, but do not exceed the upper secondary MCL of 1,000 mg/L. Salinity and nitrate concentrations in MW-3, MW-6, MW-7, and MW-10 (downgradient of the LAAs) show that some degradation has occurred with respect to salinity and nitrate, but concentrations have been fairly constant over time and are significantly less than those downgradient of the unlined ponds.

Basin Plan, Beneficial Uses, and Regulatory Considerations

41. The *Water Quality Control Plan for the Sacramento River and San Joaquin River Basins*, Fourth Edition (hereafter Basin Plan) designates beneficial uses, establishes water quality objectives, contains implementation plans and policies for protecting waters of the basin, and incorporates by reference plans and policies adopted by the State Water Board. Pursuant to Water Code section 13263(a), waste discharge requirements must implement the Basin Plan.
42. Local drainage is to Frye Creek, which is tributary to Laguna Creek and the Sacramento River within the legal boundaries of the Sacramento-San Joaquin River Delta. The beneficial uses of Sacramento-San Joaquin River Delta, as stated in the Basin Plan, are municipal and domestic supply; agricultural supply; industrial service supply; industrial process supply; navigation; water contact recreation; non-contact water recreation; warm freshwater habitat; cold freshwater habitat; wildlife habitat; and migration of aquatic organisms; spawning, reproduction, and/or early development.
43. The beneficial uses of underlying groundwater as set forth in the Basin Plan are municipal and domestic supply, agricultural supply, industrial service supply and industrial process supply.
44. The Basin Plan establishes narrative water quality objectives for chemical constituents, tastes and odors, and toxicity in groundwater. It also sets forth a numeric objective for total coliform organisms.
45. The Basin Plan's numeric water quality objective for bacteria requires that the most probable number (MPN) of coliform organisms over any seven-day period shall be less than 2.2 per 100 mL in MUN groundwater.
46. The Basin Plan's narrative water quality objectives for chemical constituents, at a minimum, require waters designated as domestic or municipal supply to meet the MCLs specified in Title 22 of the California Code of Regulations (hereafter Title 22). The Basin Plan recognizes that the Central Valley Water Board may apply limits more stringent than MCLs to ensure that waters do not contain chemical constituents in concentrations that adversely affect beneficial uses.
47. The narrative toxicity objective requires that groundwater be maintained free of toxic substances in concentrations that produce detrimental physiological responses in human, animal, plant, or aquatic life associated with designated beneficial uses.
48. Quantifying a narrative water quality objective requires a site-specific evaluation of those constituents that have the potential to impact water quality and beneficial uses. The Basin Plan states that when compliance with a narrative objective is required to protect specific beneficial uses, the Central Valley Water Board will, on a case-by-case basis, adopt numerical limitations in order to implement the narrative objective.

49. In the absence of specific numerical water quality limits, the Basin Plan methodology is to consider any relevant published criteria. General salt tolerance guidelines, such as *Water Quality for Agriculture* by Ayers and Westcot and similar references indicate that yield reductions in nearly all crops are not evident when irrigation water has an EC less than 700 $\mu\text{mhos/cm}$. There is, however, an eight- to ten-fold range in salt tolerance for agricultural crops and the appropriate salinity values to protect agriculture in the Central Valley are considered on a case-by-case basis. It is possible to achieve full yield potential with waters having EC up to 3,000 $\mu\text{mhos/cm}$ if the proper leaching fraction is provided to maintain soil salinity within the tolerance of the crop.

Antidegradation Analysis

50. State Water Resources Control Board Resolution 68-16 ("Policy with Respect to Maintaining High Quality Waters of the State") (hereafter Resolution 68-16) prohibits degradation of groundwater unless it has been shown that:
- a. The degradation is consistent with the maximum benefit to the people of the state.
 - b. The degradation will not unreasonably affect present and anticipated future beneficial uses.
 - c. The degradation does not result in water quality less than that prescribed in state and regional policies, including violation of one or more water quality objectives, and
 - d. The discharger employs best practicable treatment or control (BPTC) to minimize degradation.
51. Degradation of groundwater by some of the typical waste constituents associated with discharges from a rendering facility, after effective source control, treatment, and control measures are implemented, is consistent with the maximum benefit to the people of the state. The waste management advantages and services provided by such a rendering facility far exceed any benefits derived from requiring individuals to properly handle the waste, which would likely have a greater detrimental impact on water quality. The economic prosperity of valley communities and associated industry is of maximum benefit to the people of the State, and provides sufficient justification for allowing the limited groundwater degradation that may occur pursuant to this Order.
52. The Discharger has been monitoring groundwater quality at the site since 2003. Based on the data available, it is not possible to determine pre-1968 groundwater quality. Therefore, determination of compliance with Resolution 68-16 for this facility must be based on existing background groundwater quality.

53. Constituents of concern that have the potential to degrade groundwater include salts (primarily TDS and chloride) and nutrients as discussed below:

Constituent	Potential WQO	Effluent ¹	Average Groundwater Concentrations, mg/L		
			Background ²	Downgradient ³ of the ponds	Downgradient ⁴ of the LAAs
BOD	--	1,800	--	--	--
TDS	450 ⁵ to 1,000 ⁸	525	160	580	180
FDS	--	350	140	420	140
Nitrate as N	10 ⁶	0.8	1.6	5.3	1.7
Ammonia as N	--	325	0.1 ⁹	0.1 ¹⁰	0.1 ⁹
Sodium	69 ⁵	90	15	40	20
Chloride	106 ⁵ - 500 ⁸	80	8.5	125	7.6

¹ Average based on monitoring data from 2009 - 2013.

² Average based on MW-8 data collected from 2009 - 2013. Water quality in wells MW-8 and MW-9 are relatively similar.

³ Average based on MW-4 data collected from 2009 - 2013. MW-4 represents the highest salinity and nitrate concentrations detected in any compliance well downgradient of the unlined ponds.

⁴ Average based on MW-3 data collected from 2009 - 2013. MW-3 represents the highest salinity and nitrate concentrations detected in any compliance well downgradient of the LAAs.

⁵ Lowest agricultural water quality goal.

⁶ Primary Maximum Contaminant Level.

⁷ Secondary Maximum Contaminant Recommended Level.

⁸ Secondary Maximum Contaminant Upper Level.

⁹ Monitoring results were non-detect, value represents reporting limit.

¹⁰ Value represents the average of the detected data points with the reporting limit used for non-detects.

- a. **Total Dissolved Solids.** Since the facility and operational improvements were completed, the average effluent FDS and TDS concentrations are 350 and 525 mg/L, respectively. Based on the information included in the monthly monitoring reports between 2009 and 2013, the flow-weighted annual average FDS concentration ranged from approximately 250 to 390 mg/L. Prior to the source control improvements, the flow-weighted annual average FDS concentration in 2008 was approximately 540 mg/L. Background groundwater quality is high quality water with an average TDS concentration of 160 mg/L. The highest TDS concentration observed in a downgradient monitoring well is 580 mg/L in MW-4. Based on an inter-well comparison, the discharge to the unlined wastewater ponds has caused degradation of the underlying groundwater with respect to TDS. MW-4 TDS concentrations are above the recommended secondary MCL of 500 mg/L, but do not exceed the upper secondary MCL of 1,000 mg/L.

In general, TDS concentrations downgradient of the LAAs have been fairly constant over time and at concentrations significantly less than those downgradient of the unlined ponds. However, groundwater quality downgradient of the unlined ponds has not improved. Discharges to the unlined ponds pose a greater threat to groundwater quality than discharges to the LAAs because of the

continuous head. Although the Discharger has implemented source control, the increasing TDS trend in groundwater downgradient of the unlined ponds is a concern, and it is not clear at this time that the Discharger has implemented best practicable treatment or control for salinity. Some options available to address the salinity concerns are further source control, lining the wastewater ponds, and year round cropping of the LAAs to reduce the need for wastewater storage. This Order includes a time schedule in the Provisions that requires the Discharger to submit a feasibility study of alternatives to prevent further salinity increases in groundwater and sets a groundwater limitation for TDS that does not allow exceedance of the water quality objective. TDS concentrations in the compliance monitoring wells that monitor groundwater downgradient of the unlined ponds are significantly higher than those downgradient of the LAAs, but currently below the water quality objective. This Order allows degradation up to the water quality objective; however this Order also sets a numeric trigger concentration for TDS. If the trigger concentration is exceeded, this Order requires that the Discharger demonstrate that the increasing trend will not result in exceedance of the groundwater limitation or implement additional treatment or control measures to ensure compliance with the groundwater limitation. This Order also sets a performance-based flow-weighted annual average FDS effluent limit that will not cause groundwater quality to get any worse.

- b. **Chloride.** Chloride is an anion that moves readily through the soil column with percolation. It will not adsorb to soil as sodium can, and crop uptake of chloride is minimal for most crops. However, plants do take up chloride and excessive chloride in the soil and/or irrigation water can be toxic to crops. Crop sensitivity to chloride varies greatly, but leaching is often used to control chloride to keep crop land in production. Leaching, whether intentional or not, can degrade groundwater quality and may cause water quality objectives for chloride to be exceeded.

The average chloride effluent quality is 80 mg/L. Background chloride concentrations average 9 mg/L. The highest chloride concentration observed in a downgradient monitoring well is from MW-4 with 125 mg/L. Based on an inter-well comparison, the discharge has caused degradation of the underlying groundwater with respect to chloride. However, chloride concentrations do not exceed the recommended secondary MCL of 250 mg/L. The level of apparent degradation that has occurred is not likely causing beneficial use impacts unless the groundwater is used to irrigate the most chloride sensitive crops, such as strawberries and avocados¹.

Similar to TDS, discharges to the unlined ponds pose a greater threat to groundwater quality than discharges to the LAAs. This Order includes a time schedule in the Provisions that requires the Discharger to submit a feasibility

¹ Ayers, R.S. and D.W. Westcot, *Water Quality for Agriculture*, Food and Agriculture Organization of the United Nations – Irrigation and Drainage Paper No. 29, Rev. 1, Rome (1985), Section 4.1.1.

study of alternatives to prevent further salinity increases in groundwater. The FDS effluent limit should be sufficient to prevent significant increases in effluent chloride concentrations.

- c. **Nitrate.** For nutrients such as nitrate, the potential for groundwater degradation depends on wastewater quality; crop uptake, and the ability of the vadose zone below the LAAs to support nitrification and denitrification to convert the nitrogen to nitrogen gas before it reaches the water table. Most of the nitrogen in the process wastewater is present as ammonia, which can readily mineralize and convert to nitrate (with some loss via ammonia volatilization) in the LAAs. The effluent ammonia nitrogen concentration averages 325 mg/L. There is little nitrate nitrogen in the effluent. Background groundwater quality is high quality water with respect to nitrate and below the primary MCL of 10 mg/L. The highest nitrate concentration observed in a downgradient monitoring well is 5 mg/L in MW-4. Based on an inter-well comparison, the discharge has caused degradation of the underlying groundwater with respect to nitrate. Nitrate concentrations in groundwater downgradient of the current unlined ponds are greater than in groundwater downgradient of the LAAs. However, nitrate concentrations are below the primary MCL.

Groundwater degradation with nitrogen species such as ammonia and nitrate can be prevented by minimizing percolation below the root zone of the crops and ensuring that the total nitrogen load does not exceed crop needs over the course of a typical year. Where there is sufficient unsaturated soil in the vadose zone, excess nitrogen can be mineralized and denitrified by soil microorganisms.

Based on the waste character, long history of discharge, and site-specific geologic conditions, it appears that the vadose zone beneath the unlined ponds and LAAs provides a high level of nitrogen removal and that no additional treatment or control appears to be needed at this time. This Order requires that nutrients associated with the wastewater and other sources be applied to the LAAs at rates consistent with crop demand and sets a groundwater limitation for nitrate at the applicable water quality objective of 10 mg/L. Nitrate concentrations in the compliance wells are currently below the water quality objective, and this Order allows degradation up to the water quality objective in those wells. However, the Order also sets a numeric trigger concentration for nitrate. If the trigger concentration is exceeded, this Order requires that the Discharger demonstrate that the increasing trend will not result in exceedance of the groundwater limitation or implement additional treatment or control measures to ensure compliance with the groundwater limitation.

54. This Order establishes effluent and groundwater limitations for the facility that will not unreasonably threaten present and anticipated beneficial uses or result in groundwater quality that exceeds water quality objectives set forth in the Basin Plan.

For TDS, chloride, and nitrate, current groundwater monitoring data indicates that groundwater quality has been degraded by the discharge, but the degradation has not caused exceedance of a water quality objective and is not expected to get worse. This Order imposes effluent and mass loading rate limitations that should ensure compliance with the groundwater limits.

55. The Discharger provides treatment and control of the discharge that incorporates:
- a. Blood/liquid handling facilities to divert salts contained in these wastes into products instead of wastewater.
 - b. A pre-treatment process for partial solids settling prior to pond treatment,
 - c. Segregation and disposal off-site of high salinity waste streams that include boiler blowdown and water softener reject water,
 - d. Operation of a fully functionally tailwater and storm water runoff control system, and
 - e. Implementation of a storm water management program that improves storm water runoff quality discharged to Frye Creek.

The increasing TDS trend in groundwater downgradient of the unlined ponds is a concern, and it is not clear at this time that the Discharger has implemented best practicable treatment or control. This Order contains a schedule for a feasibility study of alternatives to prevent further salinity increases in groundwater. However, upon completion of the work, this Order may be reopened to include a time schedule for implementation of additional measures or a determination that the Discharger's current efforts represent best practicable treatment or control for salinity constituents.

Other Regulatory Considerations

56. In compliance with Water Code section 106.3, it is the policy of the State of California that every human being has the right to safe, clean, affordable, and accessible water adequate for human consumption, cooking, and sanitary purposes. This Order promotes that policy by requiring discharges to meet maximum contaminant levels designed to protect human health and ensure that water is safe for domestic use.
57. Based on the threat and complexity of the discharge, the facility is determined to be classified as 2B as defined below:
- a. Category 2 threat to water quality: "Those discharges of waste that could impair the designated beneficial uses of the receiving water, cause short-term violations of water quality objectives, cause secondary drinking water standards to be violated, or cause a nuisance."

- b. Category B complexity, defined as: “Any discharger not included [as Category A] that has physical, chemical, or biological treatment systems (except for septic systems with subsurface disposal) or any Class 2 or Class 3 waste management units.”

58. Title 27 of the California Code of Regulations (hereafter Title 27) contains regulatory requirements for the treatment, storage, processing, and disposal of solid waste. However, Title 27 exempts certain activities from its provisions. Discharges regulated by this Order are exempt from Title 27 pursuant to provisions that exempt domestic sewage, wastewater, and reuse. Title 27, section 20090 states in part:

The following activities shall be exempt from the SWRCB-promulgated provisions of this subdivision, so long as the activity meets, and continues to meet, all preconditions listed:

...(b) Wastewater - Discharges of wastewater to land, including but not limited to evaporation ponds, percolation ponds, or subsurface leachfields if the following conditions are met:

- (1) the applicable RWQCB has issued WDRs, reclamation requirements, or waived such issuance;
- (2) the discharge is in compliance with the applicable water quality control plan; and
- (3) the wastewater does not need to be managed according to Chapter 11, Division 4.5, Title 22 of this code as a hazardous waste...

59. The discharge authorized herein, and the treatment and storage facilities associated with the discharge, are exempt from the requirements of Title 27 as follows:

- a. Discharges to the Finger Lagoons, Front Winter Storage Pond, Back Winter Storage Pond, Front Mixing Pond, Back Mixing Pond, and the LAAs are exempt pursuant to Title 27, section 20090(b) because they are discharge of wastewater to land and:
 - i. The Central Valley Water Board is issuing WDRs.
 - ii. The discharge is in compliance with the Basin Plan, and;
 - iii. The wastewater discharged to the ponds does not need to be managed as hazardous waste.

60. The U.S EPA published *Statistical Analysis of Groundwater Monitoring Data at RCRA Facilities, Unified Guidance* (hereafter “Unified Guidance”) in 2009. As stated in the Unified Guidance, the document:

...is tailored to the context of the RCRA groundwater monitoring regulations ... [however, t]here are enough commonalities with other regulatory groundwater monitoring programs ... to allow for more general use of the tests and methods in the Unified Guidance... Groundwater detection monitoring involves either a comparison between different monitoring stations ... or a contrast between past and present data within a given station... The Unified Guidance also details methods to compare background data against measurements from regulatory compliance points ... [as well as] techniques for comparing datasets against fixed numerical standards ... [such as those] encountered in many regulatory programs.

The statistical data analysis methods in the Unified Guidance are appropriate for determining whether the discharge complies with Groundwater Limitations of this Order.

61. The State Water Board adopted Order 2014-0057-DWQ (NPDES General Permit CAS000001) specifying waste discharge requirements for discharges of storm water associated with industrial activities, and requiring submittal of a Notice of Intent by all affected industrial dischargers. The Discharger is required to maintain coverage under NPDES General Permit CAS000001 for discharges of storm water from the rendering plant area. Discharges of storm water from the pasture irrigated with wastewater are regulated under this Order.
62. Water Code section 13267(b) states:

In conducting an investigation specified in subdivision (a), the regional board may require that any person who has discharged, discharges, or is suspected of having discharged or discharging, or who proposes to discharge within its region ... shall furnish, under penalty of perjury, technical or monitoring program reports which the board requires. The burden, including costs of these reports, shall bear a reasonable relationship to the need for the reports and the benefits to be obtained from the reports. In requiring those reports, the regional board shall provide the person with a written explanation with regard to the need for the reports, and shall identify the evidence that supports requiring that person to provide the reports.

The technical reports required by this Order and the attached Monitoring and Reporting Program R5-2015-0084 are necessary to ensure compliance with these waste discharge requirements. The Discharger owns and operates the facility that discharges the waste subject to this Order.

63. The California Department of Water Resources sets standards for the construction and destruction of groundwater wells (hereafter DWR Well Standards), as described in *California Well Standards Bulletin 74-90* (June 1991) and *Water Well Standards: State of California Bulletin 94-81* (December 1981). These standards, and any more stringent standards adopted by the state or county pursuant to Water Code section 13801, apply to all monitoring wells used to monitor the impacts of wastewater storage or disposal governed by this Order.

64. The action to adopt waste discharge requirements for this existing facility is exempt from the provisions of the California Environmental Quality (CEQA), in accordance with the California Code of Regulations, title 14, section 15301.
65. The rendering plant and wastewater system have been in operation since 1965, and their operation is therefore exempt from the provisions of the California Environmental Quality Act (CEQA) (Pub. Resources Code, § 21000 et seq.). On 28 January 2005, the Sacramento County Department of Environmental Review and Assessment issued a mitigated Negative Declaration for the construction of Winter Storage Pond 2. The Negative Declaration required that the Discharger control potential erosion and siltation associated with earth-moving activities and comply with a Mitigation Monitoring Program.
66. The action to adopt revised waste discharge requirements for the facility is exempt from the provision of the California Environmental Quality (CEQA), in accordance with the California Code of Regulations, Title 14 section 15301.
67. Pursuant to Water Code section 13263(g), discharge is a privilege, not a right, and adoption of this Order does not create a vested right to continue the discharge.

Public Notice

68. All the above and the supplemental information and details in the attached Information Sheet, which is incorporated by reference herein, were considered in establishing the following conditions of discharge.
69. The Discharger and interested agencies and persons have been notified of the Central Valley Water Board's intent to prescribe waste discharge requirements for this discharge, and they have been provided an opportunity to submit written comments and an opportunity for a public hearing.
70. All comments pertaining to the discharge were heard and considered in a public hearing.

IT IS HEREBY ORDERED that Order R5-2005-0166 is rescinded except for purposes of enforcement and, pursuant to Water Code sections 13263 and 13267, the Sacramento Rendering Companies, its agents, successors, and assigns, in order to meet the provisions contained in Division 7 of the Water Code and regulations adopted hereunder, shall comply with the following:

A. Discharge Prohibitions

1. Discharge of wastes to surface waters is prohibited.
2. Discharge of waste classified as 'hazardous', as defined in the California Code of Regulations, title 23, section 2510 et seq., is prohibited.

3. Discharge of waste classified as 'designated', as defined in CWC Section 13173, in a manner that causes violation of groundwater limitations, is prohibited.
4. Treatment system bypass of untreated or partially treated waste is prohibited, except as allowed by Standard Provision E.2 of the *Standard Provisions and Reporting Requirements for Waste Discharge Requirements*.
5. Discharge of waste at a location or in a manner different from that described in the Findings is prohibited.
6. Discharge of toxic substances into any wastewater treatment system or land application areas such that biological treatment mechanisms are disrupted is prohibited.
7. Discharge of domestic waste to anything other than a septic system or regularly serviced portable toilets is prohibited.
8. Discharge of anything other than domestic wastewater to the septic tank and leach field system is prohibited.
9. Discharge of ion exchange regeneration brine or boiler blowdown to the process wastewater system or land application areas is prohibited.

B. Flow Limitations

1. **Effectively immediately**, influent flows to the Finger Lagoons (as measured downstream of the DAF units) shall not exceed the following limits:

Flow Measurement	Flow Limit
Monthly Average Flow ¹	150,000 gallons per day

¹ As determined by the total daily flow during the calendar month divided by the number of days in that month.

C. Effluent Limitations

1. Effluent discharged from the Finger Lagoons to the storage ponds or land application areas shall not exceed the following limits:

Constituent	Units	Flow-weighted Annual Average Limit
FDS	mg/L	450

¹ Flow-weighted average based on total flow and concentration of Finger Lagoon effluent.

Compliance with this limitation shall be calculated using the formula as specified in the Monitoring and Reporting Program.

D. Mass Loading Limitations

1. Wastewater discharged to the land application areas shall not exceed the following mass loading limits:

Constituent	Units	Daily Maximum	Cycle Average	Annual Maximum
BOD Mass Loading	lb/ac/day	200	100	--
Total Nitrogen Mass Loading	lb/ac/year	--	--	Crop Demand

Compliance with these limitations shall be calculated using the formulas as specified in the Monitoring and Reporting Program.

E. Discharge Specifications

1. No waste constituent shall be released, discharged, or placed where it will cause a violation of the Groundwater Limitations of this Order.
2. Wastewater treatment, storage, and disposal shall not cause pollution or a nuisance as defined by Water Code section 13050.
3. The discharge shall remain within the permitted waste treatment/containment structures and land application areas at all times.
4. The Discharger shall operate all systems and equipment to optimize the quality of the discharge.
5. All conveyance, treatment, storage, and disposal systems shall be designed, constructed, operated, and maintained to prevent inundation or washout due to floods with a 100-year return frequency.
6. Objectionable odors shall not be perceivable beyond the limits of the property where the waste is generated, treated, and/or discharged at an intensity that creates or threatens to create nuisance conditions.
7. As a means of discerning compliance with Discharge Specification E.6, the dissolved oxygen (DO) content in the upper one foot of any wastewater pond (with the exception of the Finger Lagoons) shall not be less than 1.0 mg/L for three consecutive weekly sampling events. If the DO in any single pond is below 1.0 mg/L for three consecutive sampling events, the Discharger shall report the findings to the Regional Water Board in writing within 10 days and shall include a specific plan to resolve the low DO results within 30 days.
8. The Discharger shall operate and maintain all ponds sufficiently to protect the integrity of containment dams and berms and prevent overtopping and/or

structural failure. Unless a California-registered civil engineer certifies (based on design, construction, and conditions of operation and maintenance) that less freeboard is adequate, the operating freeboard in any pond shall never be less than two feet (measured vertically from the lowest possible point of overflow). As a means of management and to discern compliance with this requirement, the Discharger shall install and maintain in each pond a permanent staff gauge with calibration marks that clearly show the water level at design capacity and enable determination of available operational freeboard.

9. Wastewater treatment, storage, and disposal ponds or structures shall have sufficient capacity to accommodate allowable wastewater flow, design seasonal precipitation, and ancillary inflow and infiltration during the winter while ensuring continuous compliance with all requirements of this Order. Design seasonal precipitation shall be based on total annual precipitation using a return period of 100 years, distributed monthly in accordance with historical rainfall patterns.
10. On or about **1 October** of each year, available capacity shall at least equal the volume necessary to comply with Discharge Specifications E.8 and E.9.
11. All ponds and open containment structures shall be managed to prevent breeding of mosquitoes. Specifically:
 - a. An erosion control program shall be implemented to ensure that small coves and irregularities are not created around the perimeter of the water surface.
 - b. Weeds shall be minimized through control of water depth, harvesting, or herbicides.
 - c. Dead algae, vegetation, and debris shall not accumulate on the water surface.
 - d. The Discharger shall consult and coordinate with the local Mosquito Abatement District to minimize the potential for mosquito breeding as needed to supplement the above measures.
12. Newly constructed or rehabilitated berms or levees (excluding internal berms that separate ponds or control the flow of water within a pond) shall be designed and constructed under the supervision of a California Registered Civil Engineer.
13. The Discharger shall monitor sludge accumulation in the wastewater treatment/storage ponds at least every **five years beginning in 2016**, and shall periodically remove sludge as necessary to maintain adequate storage capacity. Specifically, if the estimated volume of sludge in the reservoir exceeds five percent of the permitted reservoir capacity, the Discharger shall complete sludge cleanout within **12 months** after the date of the estimate.

F. Groundwater Limitations

Release of waste constituents from any portion of the facility shall not cause groundwater to:

1. Contain any of the specified constituents in a concentration statistically greater than the maximum allowable concentration tabulated below.

Constituent	Units	Water Quality Objective	Maximum Allowable Concentration
TDS	mg/L	1,000	1,000 ¹

¹ Applies to all compliance monitoring wells listed in the Monitoring and Reporting Program.

2. Exceed a total coliform organism level of 2.2 MPN/100mL over any seven day period.
3. Contain constituents in concentrations that exceed either the Primary or Secondary MCLs established in Title 22 of the California Code of Regulations.
4. Contain taste or odor-producing constituents, toxic substances, or any other constituents in concentrations that cause nuisance or adversely affect beneficial uses.

The monitoring wells to which these requirements apply are specified in the Monitoring and Reporting Program. Compliance with these limitations shall be determined annually based on an intra-well analysis of data from the monitoring wells specified in the Monitoring and Reporting Program using approved statistical methods.

G. Land Application Area Specifications

1. Crops or vegetation (which may include pasture grasses, native grasses and trees, crops, and/or ornamental landscaping) shall be grown in the LAAs.
2. Wastewater shall only be used to irrigate the land application areas between **15 April and 15 October each year**. Another water source may be used for irrigation at any time as needed to meet the water demands of the crops.
3. Land application of wastewater shall be managed to minimize erosion.
4. The LAAs shall be managed to prevent breeding of mosquitoes or other vectors.
5. LAAs shall be designed, maintained, and operated to comply with the following setback requirements:

Setback Definition	Minimum Irrigation Setback (feet)
Edge of LAA to property boundary	10
Edge of LAA to Frye Creek	25
Edge of LAA to domestic water supply well	100

6. Irrigation of the LAAs shall occur only when appropriately trained personnel are on duty.
7. LAAs shall be inspected periodically to determine compliance with the requirements of this Order. If an inspection reveals noncompliance or threat of noncompliance with this Order, the Discharger shall immediately implement corrective actions to ensure compliance with this Order.
8. Spray irrigation with wastewater is prohibited when wind speed (including gusts) exceeds 30 mph.
9. Sprinkler heads shall be designed, operated and maintained to create a minimum amount of mist.
10. Any irrigation runoff (tailwater) shall be confined to the LAAs or returned to the permitted waste treatment/containment structures and shall not enter any surface water drainage course or storm water drainage system.
11. Discharge to the LAAs shall not be performed during rainfall or when the ground is saturated.
12. Discharge of storm water runoff from the LAAs to off-site land or surface water drainage courses is allowed only **between 16 October and 14 April**, and only when sufficient runoff has been captured and stored such that waste constituent concentrations in any runoff discharged to surface waters do not exceed those of runoff from adjacent pasture land not irrigated with wastewater. Compliance with this requirement will be determined monthly using the monthly storm water monitoring results by comparing the Outfall BP monitoring results to the arithmetic mean of the background pasture results (Background 1 through Background 4 as shown on Attachment C).

H. Solids Disposal Specifications

Sludge, as used in this document, means the solid, semisolid, and liquid organic matter removed from wastewater treatment, settling, and storage vessels or ponds. Solid waste refers to solid inorganic matter removed by screens and soil sediments from washing of unprocessed fruit or vegetables. Except for waste solids originating from meat processing, residual solids means organic food processing byproducts such as

culls, pulp, stems, leaves, and seeds that will not be subject to treatment prior to disposal or land application.

1. Sludge and solid waste shall be removed from screens, sumps, ponds, and clarifiers as needed to ensure optimal operation and adequate storage capacity.
2. Any handling and storage of sludge, solid waste, and residual solids shall be controlled and contained in a manner that minimizes leachate formation and precludes infiltration of waste constituents into soils in a mass or concentration that will violate the groundwater limitations of this Order.
3. If removed from the site, sludge, solid waste, and residual solids shall be disposed of in a manner approved by the Executive Officer and consistent with Title 27, division 2. Removal for reuse as animal feed, or land disposal at facilities (i.e., landfills, composting facilities, soil amendment sites) operated in accordance with valid waste discharge requirements issued by a Regional Water Board will satisfy this specification.
4. Any proposed change in solids use or disposal practice shall be reported in writing to the Executive Officer at least 90 days in advance of the change.

I. Provisions

1. The following reports shall be submitted pursuant to CWC section 13267 and shall be prepared as described in Provision I.5:
 - a. By **1 September 2015**, the Discharger shall submit a *Groundwater Monitoring Well Installation Workplan* that proposes at least two additional monitoring wells to replace existing wells MW-2 and MW-3 which are downgradient of the front winter storage pond and land application area Field 1, respectively. The workplan shall be prepared in accordance with, and include the items listed in, the first section of Attachment F: "Requirements for Monitoring Well Installation Workplans and Monitoring Well Installation Reports", which is attached hereto and made part of this Order by reference. The groundwater monitoring wells shall be designed to yield samples representative of the uppermost portion of the first aquifer underlying the ponds and land application areas.
 - b. By **1 October 2015**, the Discharger shall submit a *Groundwater Limitations Compliance Assessment Plan*. The plan shall propose and justify the statistical methods used to evaluate compliance with the Groundwater Limitations of this Order for the compliance wells and constituents specified in the Monitoring and Reporting Program. Compliance shall be determined using appropriate statistical methods that have been selected based on site-specific information and the U.S. EPA Unified Guidance document cited in Finding 59 of this Order. The report shall explain and justify the selection of the appropriate statistical methods.

- c. By **1 March 2016**, the Discharger shall submit a *Salinity Minimization Feasibility Study*, which describes alternatives to prevent further salinity increases in groundwater. At a minimum, the salinity minimization alternatives shall include further source control, lining the wastewater ponds, and year round cropping of the LAAs to reduce the need for wastewater storage. The study shall include capital cost, operations and maintenance cost, net present cost analysis, and cost benefit analysis for each alternative and justification for allowing degradation with specific reference to the Resolution 68-16 criteria for allowing degradation. Upon completion of this study, this Order may be reopened to include a time schedule for implementation of the additional measures or determination that the Discharger's current efforts represent best practicable treatment or control for salinity constituents.
- d. By **1 June 2016**, the Discharger shall submit documentation verifying installation and calibration of flow meters that provide continuous, direct flow measurement of wastewater and supplemental water applied to each LAAs and a water balance that demonstrates that the wastewater ponds have sufficient storage and disposal capacity to contain the average daily flow of 150,000 gpd for both the average rainfall year and the 100-year return period total annual precipitation; including consideration of at least the following:
 - i. A minimum of two feet of freeboard in each pond at all times (unless a registered civil engineer determines that a lower freeboard level will not cause overtopping or berm failure.
 - ii. As built pond geometry;
 - iii. In-pond addition of supplemental irrigation water;
 - iv. Historical local evapotranspiration, pan evaporation, and lake evaporation data (monthly average values).
 - v. Local precipitation data with the 100-year return period annual total distributed monthly in accordance with mean monthly precipitation patterns.
 - vi. Proposed land application area hydraulic loading rates distributed monthly in accordance with crop evapotranspiration rates and allowable discharge season.
 - vii. Projected long-term percolation rates (including consideration of percolation from unlined ponds and the effects of solids plugging on all ponds).
 - viii. Capture of first flush storm water runoff.

If the updated water balance shows a storage and/or disposal capacity deficit, the Discharger shall propose specific structural and/or operational improvements that will ensure compliance with Discharge Specification E.10 will be completed no later than **30 August 2017**.

- e. By **1 July 2016**, the Discharger shall submit a *Groundwater Monitoring Well Installation Completion Report* for any new groundwater monitoring wells constructed to comply with Provision I.1.a. The report shall be prepared in accordance with, and including the items listed in, the second section of Attachment F: "Monitoring Well Workplan and Monitoring Well Installation Report Guidance", which is attached hereto and made part of this Order by reference. The report shall describe the installation and development of all new monitoring wells, and explain any deviation from the approved workplan.
2. If groundwater monitoring results show that the discharge of waste is causing groundwater to contain any waste constituents in concentrations statistically greater than the Groundwater Limitations of this Order, within **120 days** of the request of the Executive Officer, the Discharger shall submit a *BPTC Evaluation Workplan* that sets forth the scope and schedule for a systematic and comprehensive technical evaluation of each component of the facility's waste treatment and disposal system to determine best practicable treatment and control for each waste constituent that exceeds a Groundwater Limitation. The workplan shall contain a preliminary evaluation of each component of the WWTF and effluent disposal system and propose a time schedule for completing the comprehensive technical evaluation. The schedule to complete the evaluation shall be as short as practicable, and shall not exceed one year.
3. At least **180 days** prior to any sludge removal and disposal, the Discharger shall submit a *Sludge Cleanout Plan*. The plan shall include a detailed plan for sludge removal, drying, and disposal. The plan shall specifically describe the phasing of the project, measures to be used to control runoff or percolate from the sludge as it is drying, and a schedule that shows how all dried sludge will be land applied to the LAAs or removed from the site prior to the onset of the rainy season (**1 October**).
4. A discharger whose waste flow has been increasing, or is projected to increase, shall estimate when flows will reach hydraulic and treatment capacities of its treatment, collection, and disposal facilities. The projections shall be made in January, based on the last three years' average dry weather flows, peak wet weather flows and total annual flows, as appropriate. When any projection shows that capacity of any part of the facilities may be exceeded in four years, the discharger shall notify the Central Valley Water Board by **31 January**.
5. In accordance with California Business and Professions Code sections 6735, 7835, and 7835.1, engineering and geologic evaluations and judgments shall be performed by or under the direction of registered professionals competent and

proficient in the fields pertinent to the required activities. All technical reports specified herein that contain workplans for investigations and studies, that describe the conduct of investigations and studies, or that contain technical conclusions and recommendations concerning engineering and geology shall be prepared by or under the direction of appropriately qualified professional(s), even if not explicitly stated. Each technical report submitted by the Discharger shall bear the professional's signature and stamp.

6. The Discharger shall submit the technical reports and work plans required by this Order for consideration by the Executive Officer, and incorporate comments the Executive Officer may have in a timely manner, as appropriate. Unless expressly stated otherwise in this Order, the Discharger shall proceed with all work required by the foregoing provisions by the due dates specified.
7. The Discharger shall comply with Monitoring and Reporting Program R5-2015-0084, which is part of this Order, and any revisions thereto as ordered by the Executive Officer. The submittal dates of Discharger self-monitoring reports shall be no later than the submittal date specified in the MRP.
8. The Discharger shall comply with the "Standard Provisions and Reporting Requirements for Waste Discharge Requirements", dated 1 March 1991, which are attached hereto and made part of this Order by reference. This attachment and its individual paragraphs are commonly referenced as "Standard Provision(s)."
9. The Discharger shall comply with all conditions of this Order, including timely submittal of technical and monitoring reports. On or before each report due date, the Discharger shall submit the specified document to the Central Valley Water Board or, if appropriate, a written report detailing compliance or noncompliance with the specific schedule date and task. If noncompliance is being reported, then the Discharger shall state the reasons for such noncompliance and provide an estimate of the date when the Discharger will be in compliance. The Discharger shall notify the Central Valley Water Board in writing when it returns to compliance with the time schedule. Violations may result in enforcement action, including Central Valley Water Board or court orders requiring corrective action or imposing civil monetary liability, or in revision or rescission of this Order.
10. The Discharger shall at all times properly operate and maintain all facilities and systems of treatment and control (and related appurtenances) that are installed or used by the Discharger to achieve compliance with the conditions of this Order. Proper operation and maintenance also includes adequate laboratory controls and appropriate quality assurance procedures. This provision requires the operation of back-up or auxiliary facilities or similar systems that are installed by the Discharger when the operation is necessary to achieve compliance with the conditions of this Order.

11. The Discharger shall use the best practicable cost-effective control technique(s) including proper operation and maintenance, to comply with this Order.
12. As described in the Standard Provisions, the Discharger shall report promptly to the Central Valley Water Board any material change or proposed change in the character, location, or volume of the discharge.
13. The Discharger shall report to the Central Valley Water Board any toxic chemical release data it reports to the State Emergency Response Commission within 15 days of reporting the data to the Commission pursuant to section 313 of the "Emergency Planning and Community Right to Know Act of 1986."
14. At least **90 days** prior to termination or expiration of any lease, contract, or agreement involving disposal or recycling areas or off-site reuse of effluent, used to justify the capacity authorized herein and assure compliance with this Order, the Discharger shall notify the Central Valley Water Board in writing of the situation and of what measures have been taken or are being taken to assure full compliance with this Order.
15. In the event of any change in control or ownership of the facility, the Discharger must notify the succeeding owner or operator of the existence of this Order by letter, a copy of which shall be immediately forwarded to the Central Valley Water Board.
16. To assume operation as Discharger under this Order, the succeeding owner or operator must apply in writing to the Executive Officer requesting transfer of the Order. The request must contain the requesting entity's full legal name, the state of incorporation if a corporation, the name and address and telephone number of the persons responsible for contact with the Central Valley Water Board, and a statement. The statement shall comply with the signatory paragraph of Standard Provision B.3 and state that the new owner or operator assumes full responsibility for compliance with this Order. Failure to submit the request shall be considered a discharge without requirements, a violation of the CWC. If approved by the Executive Officer, the transfer request will be submitted to the Central Valley Water Board for its consideration of transferring the ownership of this Order at one of its regularly scheduled meetings.
17. A copy of this Order including the MRP, Information Sheet, Attachments, and Standard Provisions, shall be kept at the discharge facility for reference by operating personnel. Key operating personnel shall be familiar with its contents.
18. The Central Valley Water Board will review this Order periodically and will revise requirements when necessary.

If, in the opinion of the Executive Officer, the Discharger fails to comply with the provisions of this Order, the Executive Officer may refer this matter to the Attorney General for judicial

enforcement, may issue a complaint for administrative civil liability, or may take other enforcement actions. Failure to comply with this Order may result in the assessment of Administrative Civil Liability of up to \$10,000 per violation, per day, depending on the violation, pursuant to the Water Code, including sections 13268, 13350 and 13385. The Central Valley Water Board reserves its right to take any enforcement actions authorized by law.

Any person aggrieved by this action of the Central Valley Water Board may petition the State Water Board to review the action in accordance with Water Code section 13320 and California Code of Regulations, title 23, sections 2050 and following. The State Water Board must receive the petition by 5:00 p.m., 30 days after the date of this Order, except that if the thirtieth day following the date of this Order falls on a Saturday, Sunday, or state holiday, the petition must be received by the State Water Board by 5:00 p.m. on the next business day. Copies of the law and regulations applicable to filing petitions may be found on the Internet at:

http://www.waterboards.ca.gov/public_notices/petitions/water_quality

or will be provided upon request.

I, PAMELA C. CREEDON, Executive Officer, do hereby certify that the foregoing is a full true, and correct copy of an Order adopted by the California Regional Water Quality Control Board on 5 June 2015.

- Original signed by -

PAMELA C. CREEDON, Executive Officer

CALIFORNIA REGIONAL WATER QUALITY CONTROL BOARD
CENTRAL VALLEY REGION

MONITORING AND REPORTING PROGRAM R5-2015-0084

FOR
SACRAMENTO RENDERING COMPANIES
SACRAMENTO RENDERING COMPANIES RANCHO CORDOVA RENDERING PLANT
SACRAMENTO COUNTY

The Monitoring and Reporting Program (MRP) describes requirements for monitoring the ponds, finger lagoon influent and effluent, effluent to the land application areas, land application areas, groundwater, and storm water. This MRP is issued pursuant to Water Code Section 13267. The Discharger shall not implement any changes to this MRP unless and until a revised MRP is issued by the Executive Officer.

All samples shall be representative of the volume and nature of the discharge or matrix of material sampled. The time, date, and location of each sample shall be recorded on the sample chain of custody form. Field test instruments (such as those used to measure pH and dissolved oxygen) may be used provided that:

1. The operator is trained in proper use and maintenance of the instruments;
2. The instruments are calibrated prior to each monitoring event;
3. The instruments are serviced and/or calibrated by the manufacturer at the recommended frequency; and
4. Field calibration reports are submitted as described in the "Reporting" section of the MRP.

Analytical procedures shall comply with the methods and holding times specified in the following: *Methods for Organic Chemical Analysis of Municipal and Industrial Wastewater* (EPA); *Test Methods for Evaluating Solid Waste* (EPA); *Methods for Chemical Analysis of Water and Wastes* (EPA); *Methods for Determination of Inorganic Substances in Environmental Samples* (EPA); *Standard Methods for the Examination of Water and Wastewater* (APHA/AWWA/WEF); and *Soil, Plant and Water Reference Methods for the Western Region* (WREP 125). Approved editions shall be those that are approved for use by the United States Environmental Protection Agency or the California Department of Public Health's Environmental Laboratory Accreditation Program. The Discharger may propose alternative methods for approval by the Executive Officer. Where technically feasible, laboratory reporting limits shall be lower than the applicable water quality objectives for the constituents to be analyzed.

GENERAL POND MONITORING

The finger lagoons, winter storage ponds, and mixing ponds shall be monitored as follows. Freeboard shall be measured vertically from the surface of the pond water to the lowest elevation of the surrounding berm and shall be measured to the nearest 0.1 feet.

Constituent/Parameter	Units	Type of Sample	Sampling Frequency	Reporting Frequency
Influent Flow ¹	gpd	meter reading ³	daily	monthly
Flows to Mixing Ponds:				
Wastewater Flow ²	gpd	meter reading ³	daily	monthly
Fresh Water Flow ²	gpd	meter reading ³	daily	monthly
Freeboard ⁴	0.1 feet	staff gage	weekly	monthly
Dissolved Oxygen ⁵	mg/L	grab	weekly	monthly
Odors	--	observation	weekly	monthly

¹ Report as total daily flow from the DAF unit to the finger lagoons.

² Report as total daily flow to each mixing pond.

³ Prior to 1 June 2016, if there is no flow meter, flows may be estimated using calibrated pump curves and pump run times.

⁴ Report freeboard at each finger lagoon, mixing pond, and winter storage pond.

⁵ Report dissolved oxygen at finger lagoon pond 8 only, at each mixing pond, and at each winter storage pond.

FINGER LAGOON INFLUENT AND EFFLUENT MONITORING

Influent samples shall be collected at a point downstream of the DAF unit to represent the discharge to the first finger lagoon. Effluent samples shall be collected at a point downstream of the last finger lagoon prior to discharge to the land application areas or storage ponds. At a minimum, the Discharger shall monitor the finger lagoon influent and effluent as follows:

Constituent/Parameter	Units	Sample Type	Sampling Frequency		Reporting Frequency
			Influent	Effluent	
BOD ₅ ¹	mg/L	grab	monthly	monthly	monthly
Fixed Dissolved Solids	mg/L	grab	--	weekly	monthly, annually ²
Total Kjeldahl Nitrogen	mg/L	grab	--	weekly	monthly
Nitrate Nitrogen	mg/L	grab	--	weekly	monthly
Sodium	mg/L	grab	--	monthly	monthly
Chloride	mg/L	grab	--	monthly	monthly

¹ 5-day, 20°C Biochemical Oxygen Demand.

² Flow-weighted annual average FDS.

EFFLUENT MONITORING

During periods of discharge to the land application areas, the Discharger shall monitor the quantity and quality of the discharge. The Discharger shall establish one or more permanent monitoring stations within the wastewater conveyance system as needed to ensure that all samples are representative of the actual discharge from the mixing ponds to the land application areas. At a minimum, the Discharger shall monitor the effluent wastewater from each mixing pond as follows:

Constituent/Parameter	Units	Sample Type	Sampling Frequency	Reporting Frequency
Flow to each LAA:				
Wastewater/fresh water blend	gallons	meter reading ³	daily	monthly
Fresh water applied separately	gallons	meter reading ³	daily	monthly
BOD ₅ ¹	mg/L	grab	weekly	monthly
Fixed Dissolved Solids	mg/L	grab	monthly	monthly
Total Kjeldahl Nitrogen	mg/L	grab	weekly	monthly
Nitrate Nitrogen	mg/L	grab	weekly	monthly
Other salinity species ²	mg/L	grab	weekly	monthly

¹ 5-day, 20°C Biochemical Oxygen Demand.

² Includes boron, chloride, iron, manganese, sodium, and sulfate. Samples for iron and manganese shall be filtered with a 0.45-micron filter prior to sample preservation.

³ Prior to 1 June 2016, if there is no flow meter, flows may be estimated using calibrated pump curves and pump run times.

LAND APPLICATION AREA MONITORING

A. Daily Pre-Application Inspections

The Discharger shall inspect the land application areas at least **once daily** prior to and during irrigation events and observations from those inspections shall be documented for inclusion in the monthly monitoring reports. The following items shall be documented for each check or field to be irrigated on that day:

- a. Evidence of erosion;
- b. Containment berm condition;
- c. Condition of each standpipe and flow control valve (if applicable);
- d. Proper use of valves;
- e. Soil saturation;
- f. Ponding;
- g. Tailwater ditches and potential runoff to off-site areas;
- h. Potential and actual discharge to surface water;
- i. Odors that have the potential to be objectionable at or beyond the property boundary; and
- j. Insects.

Temperature; wind direction and relative strength; and other relevant field conditions shall also be observed and recorded. The notations shall also document any corrective actions taken based on observations made. A log of these inspections shall be kept at the facility and a summary of the inspections for the calendar month shall be submitted as part of the Monthly

Monitoring Report. If no irrigation with wastewater takes place during a given month, then the monthly monitoring report shall so state.

B. Routine Monitoring

The Discharger shall perform the following routine monitoring and loading calculations during all months when land application occurs, and shall present the data in the Monthly and Annual Monitoring Reports.

Constituent	Unit	Sample Type	Sampling Frequency	Reporting Frequency
Irrigation fields and checks receiving wastewater	--	observation	daily	monthly, annually
Hydraulic Loading Rate:				
Wastewater	inch	calculated ²	daily	monthly, annually
Fresh Water/Supplemental Water	inch	calculated ²	daily	monthly, annually
BOD Loading Rate:				
Daily Maximum	lb/ac/day	calculated ^{2,3}	daily	monthly, annually
Irrigation Cycle Average	lb/ac/day	calculated ^{2,3}	daily	monthly, annually
Wastewater Nitrogen Loading Rate	lb/ac	calculated ^{2,4}	daily	monthly, annually
Total Nitrogen Loading Rate, including other sources (fertilizer, manure, etc.)	lb/ac/mo	calculated ^{2,4,5}	monthly	monthly, annually

¹ Data obtained from the nearest National Weather Service rain gauge is acceptable.

² Rate shall be calculated for each irrigation check.

³ BOD₅ shall be calculated using the daily applied volume of wastewater, actual application area, and the average of the three most recent BOD₅ results.

⁴ Total nitrogen loading rates shall be calculated using the applied volume of wastewater, actual application area, and the average of the three most recent effluent monitoring results.

⁵ Loading rates for supplemental nitrogen shall be calculated using the actual load and the application area.

APPLICABILITY OF GROUNDWATER LIMITATIONS

Prior to construction and/or sampling of any groundwater monitoring wells, the Discharger shall submit plans and specifications to the Central Valley Water Board for review and approval. Once installed, all new wells shall be added to the compliance monitoring network. The following table lists all existing monitoring wells and designates the purpose of each well.

MW2 ^{2,3}	MW3 ^{2,3}	MW4 ²	MW5 ²	MW6 ²	MW7 ²	MW8 ¹	MW9 ¹	MW10 ²
--------------------	--------------------	------------------	------------------	------------------	------------------	------------------	------------------	-------------------

¹ Background well not used for compliance monitoring.

² Compliance well.

³ To be replaced.

The Groundwater Limitations set forth in Section F of the WDRs shall apply to the specific compliance monitoring wells tabulated below. This table is subject to revision by the Executive Officer following construction of any new compliance monitoring wells.

Constituent	Groundwater Limitation	Compliance Wells to which Limitation Applies
TDS	1,000 mg/L ¹	MW2, MW3, MW4, MW5, MW6, MW7, MW10
All Others	Concentrations that exceed either the Primary or Secondary MCL.	MW2, MW3, MW4, MW5, MW6, MW7, MW10
All Others	Taste or odor-producing constituents, toxic substances, or any other constituents in concentrations that cause nuisance or adversely affect beneficial uses.	MW2, MW3, MW4, MW5, MW6, MW7, MW10

¹ Compliance with this requirement shall be determined on an intra-well basis for each of the specified wells using approved statistical methods.

GROUNDWATER MONITORING

Prior to construction and/or sampling of any groundwater monitoring wells, the Discharger shall submit plans and specifications to the Central Valley Water Board for review and approval. Unless otherwise expressly approved, water supply wells shall not be used as monitoring wells. Once installed, all new monitoring wells shall be added to the MRP and shall be sampled and analyzed according to the schedule below.

Prior to sampling, the groundwater elevations shall be measured and the wells shall be purged of at least three well volumes until temperature, pH, and electrical conductivity have stabilized. Depth to groundwater shall be measured to the nearest 0.01 feet. Samples shall be collected and analyzed using standard EPA methods. Groundwater monitoring shall include, at a minimum, the following:

Constituent/Parameter	Units	Sample Type	Sampling Frequency³	Reporting Frequency³
Depth to Groundwater	feet	measurement	semi-annual	semi-annual
Groundwater Elevation ¹	feet	calculated	semi-annual	semi-annual
Gradient Magnitude	feet/feet	calculated	semi-annual	semi-annual
Gradient Direction	degrees	calculated	semi-annual	semi-annual
pH	pH units	grab	semi-annual	semi-annual
Total Dissolved Solids	mg/L	grab	semi-annual	semi-annual
Nitrate as Nitrogen	mg/L	grab	semi-annual	semi-annual
Other Salinity Species ²	mg/L	grab	semi-annual	semi-annual

¹ Groundwater elevation shall be determined based on depth-to-water measurements using a surveyed measuring point elevation on the well and a surveyed reference elevation.

² Includes boron, chloride, iron, manganese, sodium, and sulfate. Samples for iron and manganese shall be filtered with a 0.45-micron filter prior to sample preservation.

³ Semi-annual groundwater monitoring shall occur in the first (January – March) and third (July – September) quarter of each calendar year.

Groundwater Trigger Concentrations

The following groundwater trigger concentrations are intended only to serve as a means of assessing whether the discharge might potentially cause a violation of one or more of the Groundwater Limitations of the WDRs at some later date.

Constituent	Compliance Wells	Trigger Concentration, mg/L
Total Dissolved Solids	MW2, MW3, MW4, MW5, MW6, MW7, MW10	700
Nitrate as N	MW2, MW3, MW4, MW5, MW6, MW7, MW10	7.0

If the annual evaluation of groundwater quality performed pursuant to this MRP shows that the annual average of the trigger concentration has been exceeded in any compliance well during the calendar year, the Discharger shall submit either of the following technical reports by **1 May of the following calendar year** (e.g., if the trigger concentration is exceeded for calendar year 2020, the appropriate report is due by 1 May 2021):

- a. A technical evaluation of the reason(s) for the concentration increase[s] for each constituent and a technical demonstration that, although the concentration has increased more than expected in one or more compliance wells, continuing the discharge without additional treatment or control will not result in exceedance of the applicable groundwater limitation.
- b. An Action Plan that presents a systematic technical evaluation of each component of the facility’s waste treatment and disposal system to determine whether additional treatment or control is feasible for each waste constituent that exceeds a trigger concentration. The plan shall evaluate each component of the wastewater treatment, storage, and disposal system (as applicable); describe available treatment and/or control technologies; provide preliminary capital and operation/maintenance cost estimates for each; designate the preferred option[s] for implementation; and specify a proposed implementation schedule. The schedule for full implementation shall not exceed one year, and the Discharger shall immediately implement the proposed improvements.

STORM WATER MONITORING

The Discharger shall monitor the quality of storm water discharged from the land application areas to surface water. Permanent sampling locations shall be established to provide representative samples from each of the following sampling locations: the background pasture area (Background 1, 2, 3 and 4), Frye Creek upgradient of Outfall OpA, Outfall OpA, Outfall BP, and Frye Creek downgradient of Outfall BP, as shown on Attachment C of the WDRs. Samples from each location shall be obtained monthly during the first precipitation event of the month that generates runoff from the LAAs to Frye Creek.

However, sampling may be deferred to the next weekday during daylight hours as needed. If there is no precipitation during the month that generates runoff from the LAAs to Frye Creek, the Monthly Monitoring Report shall so state.

Constituent/Parameter	Units	Sample Type	Sampling Frequency	Reporting Frequency
pH	pH Units	grab	monthly	monthly
BOD	mg/L	grab	monthly	monthly
Total Dissolved Solids	mg/L	grab	monthly	monthly
Total Kjeldahl Nitrogen	mg/L	grab	monthly	monthly
Ammonia as Nitrogen	mg/L	grab	monthly	monthly
Nitrate as Nitrogen	mg/L	grab	monthly	monthly

POND SLUDGE MONITORING

The Discharger shall keep records regarding the quantity of pond sludge removed from all ponds; any sampling and analytical data; the quantity of sludge stored on site; and the quantity removed for disposal. The records shall also indicate that steps taken to reduce odor and other nuisance conditions. Records shall be stored onsite and available for review during inspections.

If sludge is transported off-site for disposal, then the Discharger shall submit records identifying the hauling company, the amount of sludge transported, the date removed from the facility, the location of disposal, and copies of all analytical data required by the entity accepting the waste. All records shall be submitted as part of the Annual Monitoring Report.

REPORTING

All monitoring reports should be converted to a searchable Portable Document Format (PDF) and submitted electronically. Documents that are less than 50MB should be emailed to: centralvalleysacramento@waterboards.ca.gov.

To ensure that your submittal is routed to the appropriate staff person, the following information should be included in the body of the email:

Attention: Compliance/Enforcement Section
Rancho Cordova Rendering Plant
Sacramento Rendering Company
Sacramento County
Place ID: 254982

Documents that are 50 MB or larger should be transferred to a CD, DVD, or flash drive and mailed to the following address:

Central Valley Regional Water Quality Control Board
ECM Mailroom
11020 Sun Center Drive, Suite 200
Rancho Cordova, California 95670

Please include a transmittal sheet that includes the following:

Attention: Compliance/Enforcement Section
Rancho Cordova Rendering Plant
Sacramento Rendering Company
Sacramento County
Place ID: 254982

In reporting monitoring data, the Discharger shall arrange the data in tabular form so that the date, sample type (e.g., effluent, groundwater), sampling location, and the reported analytical result for each sample are readily discernible. The data shall be summarized in such a manner to clearly illustrate compliance with waste discharge requirements and spatial or temporal trends, as applicable. The results of any monitoring done more frequently than required at the locations specified in the Monitoring and Reporting Program shall be reported in the next scheduled monitoring report.

As required by the California Business and Professions Code Sections 6735, 7835, and 7835.1, all groundwater monitoring reports shall be prepared under the direct supervision of a California-registered professional and signed by the registered professional.

A. Monthly Monitoring Reports

Daily, weekly, and monthly monitoring data shall be reported in the monthly monitoring report. Monthly reports shall be submitted to the Central Valley Water Board on the **1st day of the second month following sampling** (i.e., the January report is due by 1 March). At a minimum, the reports shall include:

1. Tabulated general pond monitoring data for the month, including daily flow and comparison to the Flow Limitations of the WDRs.
2. Tabulated finger lagoon influent and effluent monitoring data and comparison to the Effluent Limitations of the WDRs.
3. Tabulated effluent (discharged to each designated land application area) monitoring data for the month and comparison to the Effluent Limitations of the WDRs.
4. Tabulated land application area monitoring data for the month, including hydraulic and constituent loading rates and comparison to the Mass Loading Limitations of the WDRs.
5. Tabulated storm water monitoring data for the month and comparison of the Outfall BP monitoring results to the arithmetic mean of the background pasture results

(Background 1 through Background 4). If storm water samples were not collected because there was no runoff from the LAAs during the month, the report shall so state.

6. A summary of the daily pre-irrigation inspection reports and a notation of any corrective actions taken based on observations made.
7. A comparison of monitoring data to the flow limitations, effluent limitations, discharge specifications and applicable limitations and an explanation of any violation of those requirements.
8. If requested by staff, copies of laboratory analytical report(s).
9. The most recent calibration log sheet(s) verifying calibration of any field monitoring instruments (e.g., DO and pH meters) used to obtain data.

B. Semi-Annual Monitoring Reports

The Discharger shall establish a semi-annual groundwater sampling schedule such that samples are obtained approximately every six months. Semi-annual monitoring reports shall be submitted to the Central Valley Water Board by the **1st day of the second month after the sampling period** (i.e. the January-March sample period is due by May 1st) each year. The Semi-annual Report shall include the following:

1. Results of the semi-annual monitoring of the groundwater in tabular format.
2. A narrative description of all preparatory, monitoring, sampling, and analytical testing activities for the monitoring. The narrative shall be sufficiently detailed to verify compliance with the WDR, this MRP, and the Standard Provisions and Reporting Requirements. The narrative shall be supported by field logs for each well documenting depth to groundwater; parameters measured before, during, and after purging; method of purging; calculation of casing volume; and total volume of water purged.
3. Calculation of groundwater elevations, an assessment of groundwater flow direction and gradient on the date of measurement, comparison of previous flow direction and gradient data, and discussion of seasonal trends if any.
4. Summary data tables of historical and current water table elevations and analytical results.
5. A scaled map showing relevant structures and features of the facility, the disposal check boundaries, the locations of monitoring wells, and groundwater elevation contours referenced to mean sea level datum.
6. Copies of laboratory analytical report(s) for groundwater monitoring.

C. Annual Report

An Annual Report shall be submitted to the Central Valley Water Board by **1 February** of each year. The Annual Report shall present a summary of all monitoring data obtained during the previous calendar year, and shall include the following.

1. The flow-weighted annual average FDS concentration of the wastewater discharged to the LAAs and comparison to the Effluent Limitations of the WDRs. The flow-weighted annual average FDS concentration shall be calculated using the following formula:

$$C_a = \frac{\sum_{1}^{12} [(C_{Pi} \times V_{Pi})]}{\sum_{1}^{12} (V_{Pi})}$$

Where: C_a = Flow-weighted annual average FDS concentration in mg/L
 C_{pi} = Monthly average process wastewater FDS concentration for calendar month i in mg/L
 V_{pi} = volume of process wastewater applied to LAAs during calendar month i in million gallons
 i = the number of the month (e.g., January = 1, February = 2, etc.)

2. The total hydraulic loading rate for wastewater and supplemental water applied to each LAA for the calendar year (measured in inches/year) and comparison to measured evapotranspiration (ET) values for the calendar year.
3. A summary of daily maximum and irrigation cycle average BOD loading rates applied to each LAA for the calendar year and comparison to the Mass Loading Limitations of the WDRs. Compliance with the BOD requirements shall be determined as specified below:
 - a. The mass of BOD applied to each LAA on a daily basis shall be calculated using the following formula:

$$M = \frac{8.345(CV)}{A}$$

Where: M = mass of BOD applied to an LAA in lb/ac/day
 C = concentration of BOD in mg/L based on average of the three most recent monitoring result
 V = volume of wastewater applied to the LAA in millions of gallons per day
 A = area of the LAA irrigated in acres
8.345 = unit conversion factor

- b. The mass of BOD applied to each LAA on an irrigation cycle average shall be calculated using the following formula:

$$M = \frac{8.345(CV)}{AT}$$

- Where:
- M = mass of BOD applied to an LAA in lb/ac/cycle
 - C = concentration of BOD in mg/L based on average of the three most recent monitoring result
 - V = volume of wastewater applied to the LAA in millions of gallons per day
 - A = area of the LAA irrigated in acres
 - T = Time between subsequent wastewater applications (days of application plus days of drying) in days
- 8.345 = unit conversion factor

4. The total nitrogen and plant available nitrogen (PAN) loading rate applied to each LAA for the calendar year with supporting data and calculations and comparison to crop nitrogen demand for the crops actually grown. The mass of total nitrogen applied to each LAA on an annual basis shall be calculated using the following formula:

$$M = \sum_{i=1}^{12} \frac{(8.345(C_i V_i) + M_x)}{A}$$

- Where:
- M = mass of nitrogen applied to LAA in lb/ac/yr
 - C_i = Concentration of total nitrogen for month i in mg/L based on average of the three most recent monitoring result
 - V_i = volume of wastewater applied to the LAA during calendar month i in million gallons
 - A = area of the LAA irrigated in acres
 - i = the number of the month (e.g., January = 1, February = 2, etc.)
 - M_x = nitrogen mass from other sources (e.g., fertilizer and livestock manure) in pounds
- 8.345 = unit conversion factor

5. An evaluation of the performance of the pretreatment systems and finger lagoons.
6. A narrative discussion of the analytical results for all groundwater locations monitored including spatial and temporal trends, with reference to summary data tables, graphs, and appended analytical reports (as applicable).

7. Concentration vs. time graphs for each monitored constituent using all historic groundwater monitoring data. Each graph shall show the trigger concentration specified above (where applicable) and the Groundwater Limitation as horizontal lines at the applicable concentration.
8. An evaluation of the groundwater quality beneath the site and determination of whether any trigger concentrations were exceeded in any compliance well for the calendar year. This shall be determined by comparing the annual average concentration for each well during the calendar year to the corresponding trigger concentration specified above. If any groundwater trigger concentrations were exceeded, include acknowledgment that the technical report described in the Groundwater Trigger Concentrations section of this MRP will be submitted in accordance with the specified schedule.
9. An evaluation of the groundwater quality beneath the site, determination of compliance with the Groundwater Limitation F.1 of the WDRs based on statistical analysis for each constituent monitored for each compliance well in accordance with the approved *Groundwater Limitations Compliance Assessment Plan*, and an explanation of any violation of those requirements. Include all calculations and data input/analysis tables derived from use of statistical software, as applicable.
10. An evaluation of storm water quality and compliance with Land Application Area Specification G.12. If any LAA runoff results exceed the results for the background sample, the report shall describe the specific structural and/or operational practices that will be implemented during the subsequent rainy season and thereafter to ensure compliance with Land Application Area Specification G.12.
11. A narrative description of wastewater residual solids and pond sludge disposal practices.
12. A discussion of compliance and the corrective action taken, as well as any planned or proposed actions needed to bring the discharge into full compliance with the waste discharge requirements.
13. An evaluation of the performance of the treatment facility, including discussion of capacity issues, system problems, and a forecast of the flows anticipated in the next year.
14. A discussion of the following:
 - a. Waste constituent reduction efforts implemented in accordance with any required workplan;
 - b. Other treatment or control measures implemented during the calendar year either voluntarily or pursuant to the WDRs, this MRP, or any other Order;
 - c. A discussion of anticipated pond sludge removal in the coming year, and if so, include anticipated schedule for cleaning, drying, and disposal; and
 - d. Based on monitoring data, an evaluation of the effectiveness of the treatment or control measures implemented to date.

15. A discussion of any data gaps and potential deficiencies/redundancies in the monitoring system or reporting program.

A letter transmitting the self-monitoring reports shall accompany each report. The letter shall include a discussion of requirement violations found during the reporting period, and actions taken or planned for correcting noted violations, such as operation or facility modifications. If the Discharger has previously submitted a report describing corrective actions and/or a time schedule for implementing the corrective actions, reference to the previous correspondence will be satisfactory. The transmittal letter shall contain the penalty of perjury statement by the Discharger, or the Discharger's authorized agent, as described in the Standard Provisions General Reporting Requirements Section B.3.

The Discharger shall implement the above monitoring program as of the date of this Order.

Ordered by: _____ - Original signed by -
PAMELA C. CREEDON, Executive Officer
5 June 2015

(Date)

LLA: 051515

INFORMATION SHEET

ORDER R5-2015-0084
SACRAMENTO RENDERING COMPANIES
SACRAMENTO RENDERING COMPANY RANCHO CORDOVA RENDERING PLANT
SACRAMENTO COUNTY

Current Facility Description

Sacramento Rendering Companies owns and operates the Rancho Cordova Rendering Plant at 11350 Kiefer Boulevard in Rancho Cordova that generates the animal rendering process wastewater and the land to which the waste is discharged.

WDRs R5-2005-0166 allows a monthly average wastewater flow up to 150,000 gallons per day (gpd) and established the following interim effluent limitations:

Constituent	Units	Monthly Average Concentration
Total Dissolved Solids	mg/L	2,000
Total Nitrogen	mg/L	750

Companion CDO R5-2005-0167 was adopted on the same day and required the Discharger to perform various tasks and comply with a time schedule to implement measures and improvements required to ensure compliance with WDRs R5-2005-0166. CDO R5-2005-0167 was rescinded on 10 October 2014 because the Discharger completed the required studies and certain facility and operational improvements, and submitted a new RWD as required.

The rendering plant processes livestock carcasses, meat and poultry processing by-products, and grease from restaurants and other food services businesses. The facility has been operating at this site since 1956. Approximately 750,000 pounds per day of animal by-products is processed. The rendering process typically operates 24 hours per day, seven days per week.

Wastewater generated by the rendering plant consists of moisture from animal by-products, water separated from grease, condensate from the continuous cookers, contact water from the Venturi scrubber and Scrubbers 1 through 4, plant sanitation wastewater, water softener reject, boiler blowdown, and incidental storm water runoff from some roof drains and the exterior part of the processing plant's front loading area. The combined wastewater stream from all sources contains high concentrations of BOD, TDS, and nitrogen (primarily in the form of ammonia).

The process wastewater undergoes a pretreatment process to remove excess oil and grease, anaerobic treatment in eight unlined small and shallow lagoons (Finger Lagoons), is stored in unlined ponds (Front and Back Winter Storage Ponds and Front and Back Mixing Ponds), and is then used to irrigate land application areas (LAAs) that serve as pasture. The LAAs consist of six fields totaling approximately 85 acres and is irrigated by flood irrigation. Cattle and sheep are allowed to graze the LAAs. Supplemental irrigation

water is periodically applied directly to the fields to dilute dissolved solids and other constituents in the wastewater and supplement the water demand of grass in the fields.

Changes to Facility and Discharge

In response to CDO R5-2005-0167, the Discharger evaluated additional treatment and source control measures and by February 2009 implemented the following:

- a. Construction of an additional land application area (Field 6) to reduce mass loading of nitrogen on a per acre basis.
- b. Construction of blood/liquid handling facilities that divert salts contained in the blood and liquids into products instead of wastewater.
- c. Segregation and off-site disposal of boiler blowdown and water softener reject water at a permitted facility.
- d. Implementation of a field flushing program with supplemental irrigation water prior to the start of the rainy season, to improve the quality of storm water runoff discharged to Frye Creek. Tailwater generated during the flushing operation is collected in the winter storage ponds.
- e. Following each grazing rotation, use of a tractor-mounted chain or spike drag pulled across the field to break up manure into smaller particles. Reduction in particle size increases the potential for additional nitrogen loss through ammonia volatilization and improves the subsequent leaching and decomposition of organic matter and nutrients in the soil.
- f. Protection of all tailwater and storm water collection trenches, pipe entrances, valves, and other tailwater and storm water conveyances from cattle intrusions; and repair as necessary to minimize erosion and impacts from cattle wastes.

Wastewater quality at this facility has improved since implementation of the source control measures described above.

WDRs R5-2005-0166 requires that the total nitrogen loading to each LAA irrigation check not exceed the agronomic rate for plant available nitrogen (PAN) for the type of crop grown. In compliance with CDO R5-2005-0167, the Discharger provided a method of calculating PAN based on waste character and site-specific physical and climatic conditions. Despite improvements to the LAA operations, loading rate data show that total nitrogen loading rates have occasionally exceeded agronomic rates for PAN at some of the LAAs in violation of the WDRs.

Storm water monitoring was established to determine whether the Discharger's current LAA storm water retention program and storm water best management practices were adequate to protect surface water quality during the entire rainy season. Currently, storm

water runoff generated during the first significant rainfall event is directed to the Winter Storage Ponds. In an effort to improve storm water runoff quality, the Discharger has implemented the following Best Management Practices (BMPs);

- a. Implementation of a field flushing program each fall with groundwater prior to discharging storm water to Frye Creek, as discussed further below.
- b. Following each grazing rotation, a tractor-mounted chain or spike drag is pulled across the field to break up manure into smaller particles. Reductions in particle size should increase the potential for additional nitrogen loss through ammonia volatilization and should improve the subsequent leaching and decomposition of organic matter and nutrients in the soil.
- c. All tailwater and storm water collection trenches, pipe entrances, valves, and other tailwater and storm water conveyances are protected from cattle intrusion, and when necessary, such conveyances are repaired to minimize erosion and impacts from cattle wastes.
- d. In general, storm water runoff from the LAAs contains some constituents (particularly salinity constituents and nutrients) at concentrations greater than background concentrations measured in unirrigated, adjacent land and storm water quality in Frye Creek upgradient of the facility in violation of the WDRs. Continued monitoring of the LAA storm water retention program is necessary to determine whether current operational practices are sufficient or whether additional flushing of the LAAs and/or cessation of waste discharge to the LAAs earlier than 15 October each year is appropriate.

The 2007 RWD did not include a water balance. The Discharger has not indicated that the wastewater flow will increase. Monthly monitoring reports do not indicate any storage and disposal capacity issues. Based on the water balance submitted in 2005 for preparation of WDRs R5-2005-0106, the facility has adequate wastewater and storm water storage capacity to accommodate an average daily flow of 150,000 gallons. However, major structural and operational changes were implemented after that time. This Order continues the previous flow limit but requires that the Discharger submit an updated water balance to verify sufficient capacity while ensuring an appropriate level of LAA runoff retention at the beginning of each rainy season.

Site-Specific Conditions

The rendering plant area is relatively level, and the irrigated pasture areas are gently sloped at an elevation of approximately 145 feet above mean sea level. Surrounding land uses have been historically rural and agricultural. However, the area is undergoing urban development and residential developments now neighbor the facility.

Frye Creek originates immediately west of the back pasture area and drains to the southwest. The creek is an ephemeral stream that collects storm water runoff from the property during the wet weather months. The Federal Emergency Management Agency

does not identify Frye Creek as a flood hazard and the facility is not constructed within a 100-year flood zone.

The County of Sacramento Municipal Services Agency, Department of Water Resources identified the facility to be within a Local Flood Hazard Area. It appears that the designation was made without a formal hydrologic study. Local Flood Hazard Area designations are locations where standing water has been observed or reports of flooding have been submitted to the County.

Groundwater Conditions

Groundwater is generally encountered at approximately 140 feet below the ground surface (5 feet above mean sea level) and generally flows west to southwest. Nine groundwater monitoring wells (MW-2 through MW-10) monitor first encountered groundwater quality.

Based on an inter-well analysis, monitoring data show that the unlined storage ponds (particularly the Front Winter Storage Pond, Finger Lagoons, and Back Mixing Pond) have caused some degradation of the underlying groundwater with respect to TDS, chloride, and nitrate; but have not caused an exceedance of a water quality objective. MW-4 TDS concentrations are above the recommended secondary MCL of 500 mg/L, but do not exceed the upper secondary MCL of 1,000 mg/L. Salinity and nitrate concentrations in wells downgradient of the LAAs show that some degradation has occurred with respect to salinity and nitrate, but concentrations have been fairly constant over time and are significantly less than those downgradient of the unlined ponds.

Basin Plan, Beneficial Uses, and Regulatory Considerations

Local drainage is to Frye Creek, which is tributary to Laguna Creek and the Sacramento River within the legal boundaries of the Sacramento-San Joaquin River Delta. The beneficial uses of Sacramento-San Joaquin River Delta, as stated in the Basin Plan, are municipal and domestic supply; agricultural supply; industrial service supply; industrial process supply; navigation; water contact recreation; non-contact water recreation; warm freshwater habitat; cold freshwater habitat; wildlife habitat; and migration of aquatic organisms; spawning, reproduction, and/or early development. The beneficial uses of underlying groundwater as set forth in the Basin Plan are municipal and domestic supply, agricultural supply, industrial service supply and industrial process supply.

Antidegradation Analysis

Constituents of concern that have the potential to degrade groundwater include salts (primarily TDS and chloride) and nutrients. For TDS, chloride, and nitrate, current groundwater monitoring data indicates that groundwater quality has been degraded by the discharge, but the degradation has not caused exceedance of a water quality objective and is not expected to get worse. This Order imposes effluent and mass loading rate limitations that should ensure compliance with the groundwater limits.

This Order allows degradation up to the water quality objective; however this Order also sets a numeric trigger concentration for TDS and nitrate. If the trigger concentration is

exceeded, this Order requires that the Discharger demonstrate that the increasing trend will not result in exceedance of the groundwater limitation or implement additional treatment or control measures to ensure compliance with the groundwater limitation.

The Discharger provides treatment and control of the discharge that incorporates:

- a. Blood/liquid handling facilities to divert salts contained in these wastes into products instead of wastewater.
- b. A pre-treatment process for partial solids settling prior to pond treatment,
- c. Segregation and disposal off-site of high salinity waste streams that include boiler blowdown and water softener reject water,
- d. Operation of a fully functionally tailwater and storm water runoff control system, and
- e. Implementation of a storm water management program that improves storm water runoff quality discharged to Frye Creek.

The increasing TDS trend in groundwater downgradient of the unlined ponds is a concern, and it is not clear at this time that the Discharger has implemented best practicable treatment or control. This Order contains a schedule for a feasibility study of alternatives to prevent further salinity increases in groundwater. However, upon completion of the work, this Order may be reopened to include a time schedule for implementation of additional measures or a determination that the Discharger's current efforts represent best practicable treatment or control for salinity constituents.

Discharge Prohibitions, Specifications, and Provisions

This Order prescribes effluent and groundwater limitations that ensure the discharge does not affect present and anticipated future beneficial uses of groundwater or result in groundwater quality that exceeds water quality objectives set forth in the Basin Plan.

This Order restricts the discharge of wastewater to irrigate the land application areas between 15 April and 15 October each year. Discharge of storm water runoff from the LAAs to off-site land or surface water drainage courses is allowed only between 16 October and 14 April, and only when sufficient runoff has been captured and stored such that waste constituent concentrations in any runoff discharged to surface waters do not exceed those of runoff from adjacent pasture land not irrigated with wastewater.

The Monitoring and Reporting Program is designed to verify compliance with flow, effluent, mass loading and groundwater limitations and operational requirements of the WDRs.

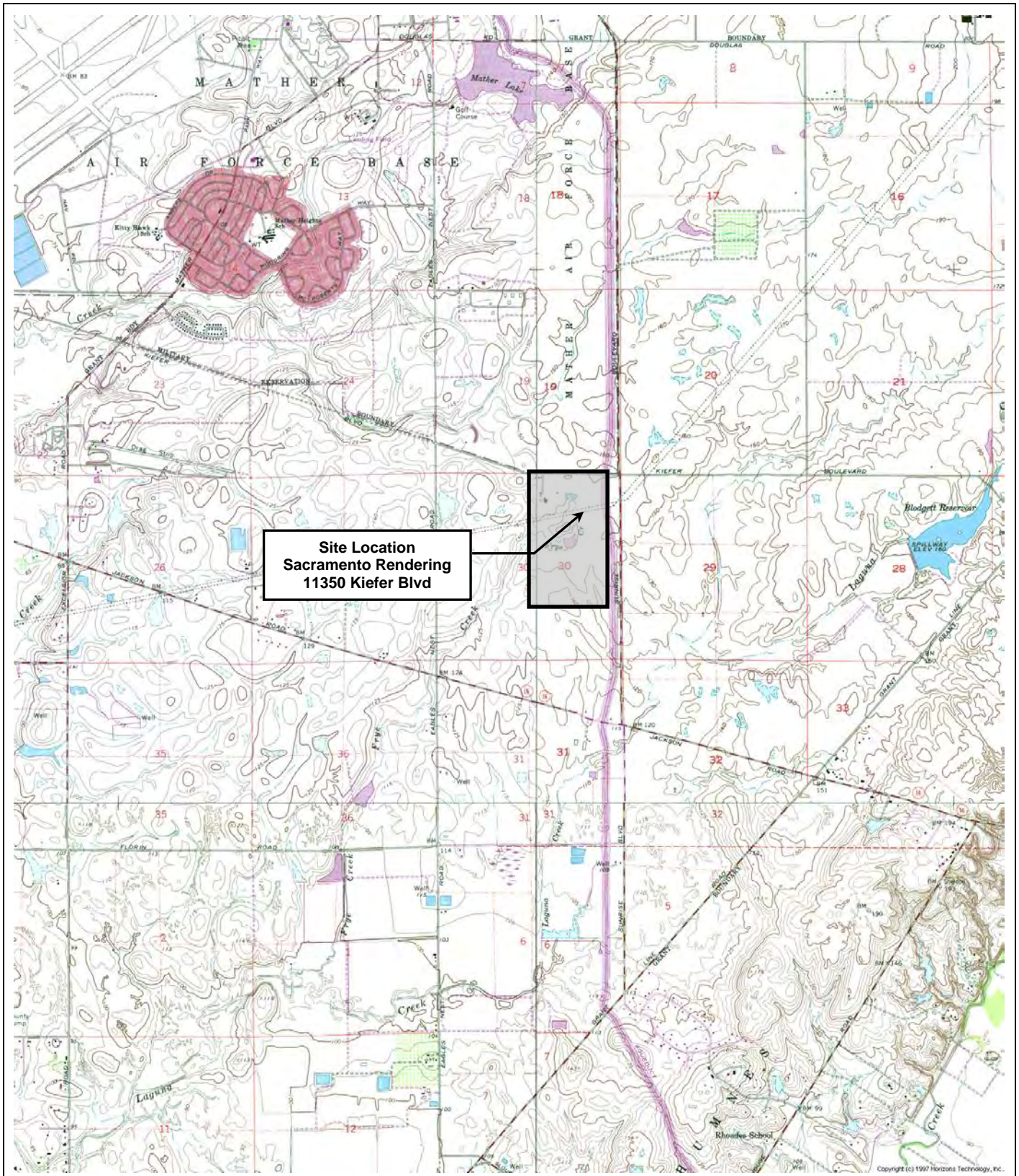

Drawing Reference:
U.S.G.S
East Sacramento
TOPOGRAPHIC MAP
7.5 MINUTE QUAD

SITE LOCATION MAP
SACRAMENTO RENDERING COMPANIES
RANCHO CORDOVA RENDERING PLANT
SACRAMENTO COUNTY

Approximate Scale
1 in. = 4,000 ft.

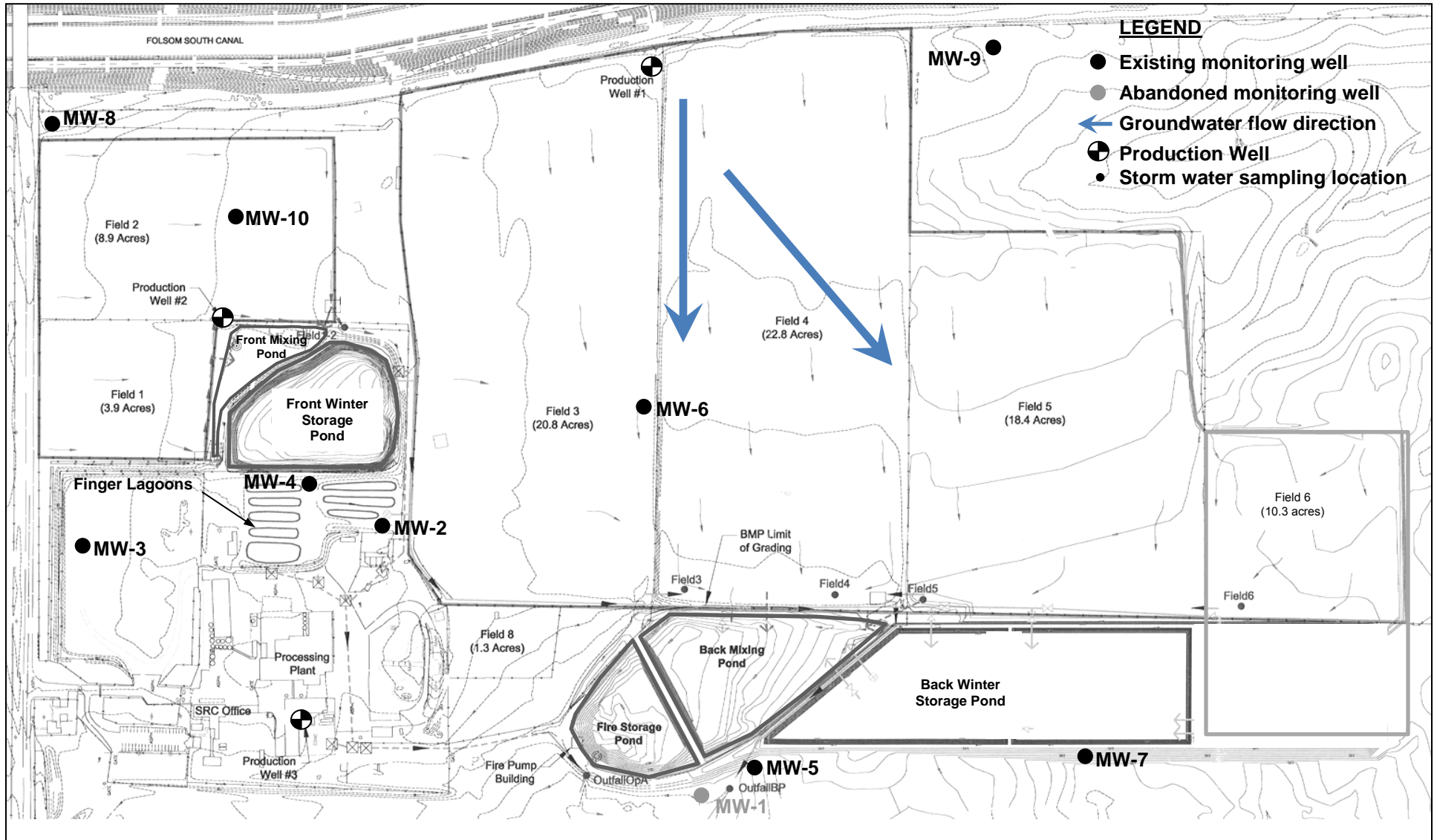

Drawing Reference:
 Report of Waste Discharge
 30 November 2007

SITE PLAN & MONITORING WELL LOCATIONS
 SACRAMENTO RENDERING COMPANIES
 RANCHO CORDOVA RENDERING PLANT
 SACRAMENTO COUNTY

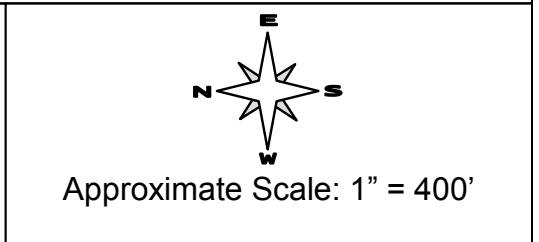

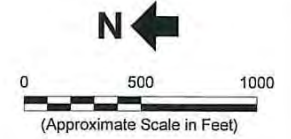
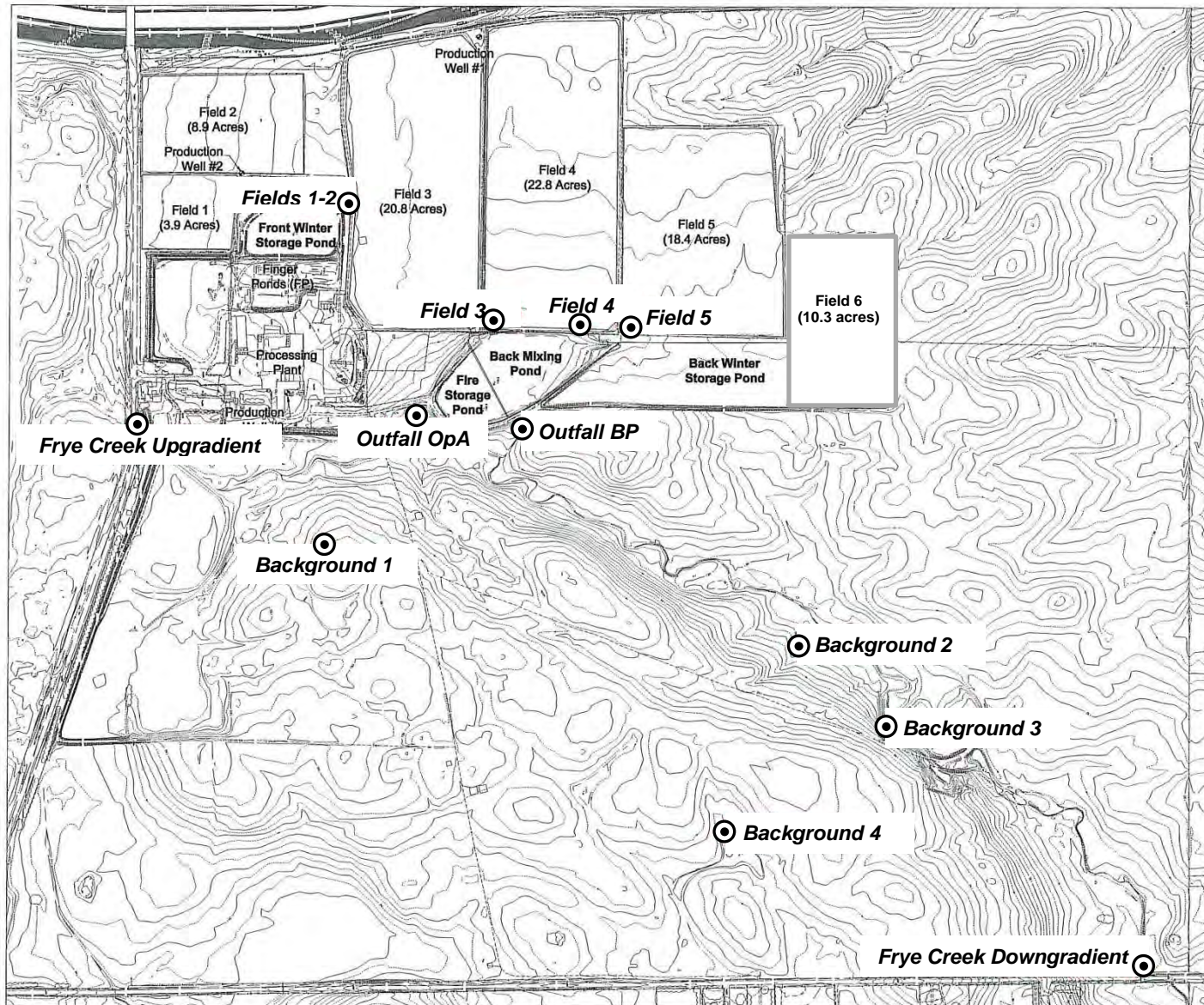

Legend:

- ⊙ Approximate Stormwater Sampling Location

Notes:

1. All locations are approximate.

Approximate Scale
As Noted Above



Drawing Reference:
Storm Water Monitoring Report
30 June 2006

STORM WATER SAMPLING LOCATIONS
SACRAMENTO RENDERING COMPANIES
RANCHO CORDOVA RENDERING PLANT
SACRAMENTO COUNTY

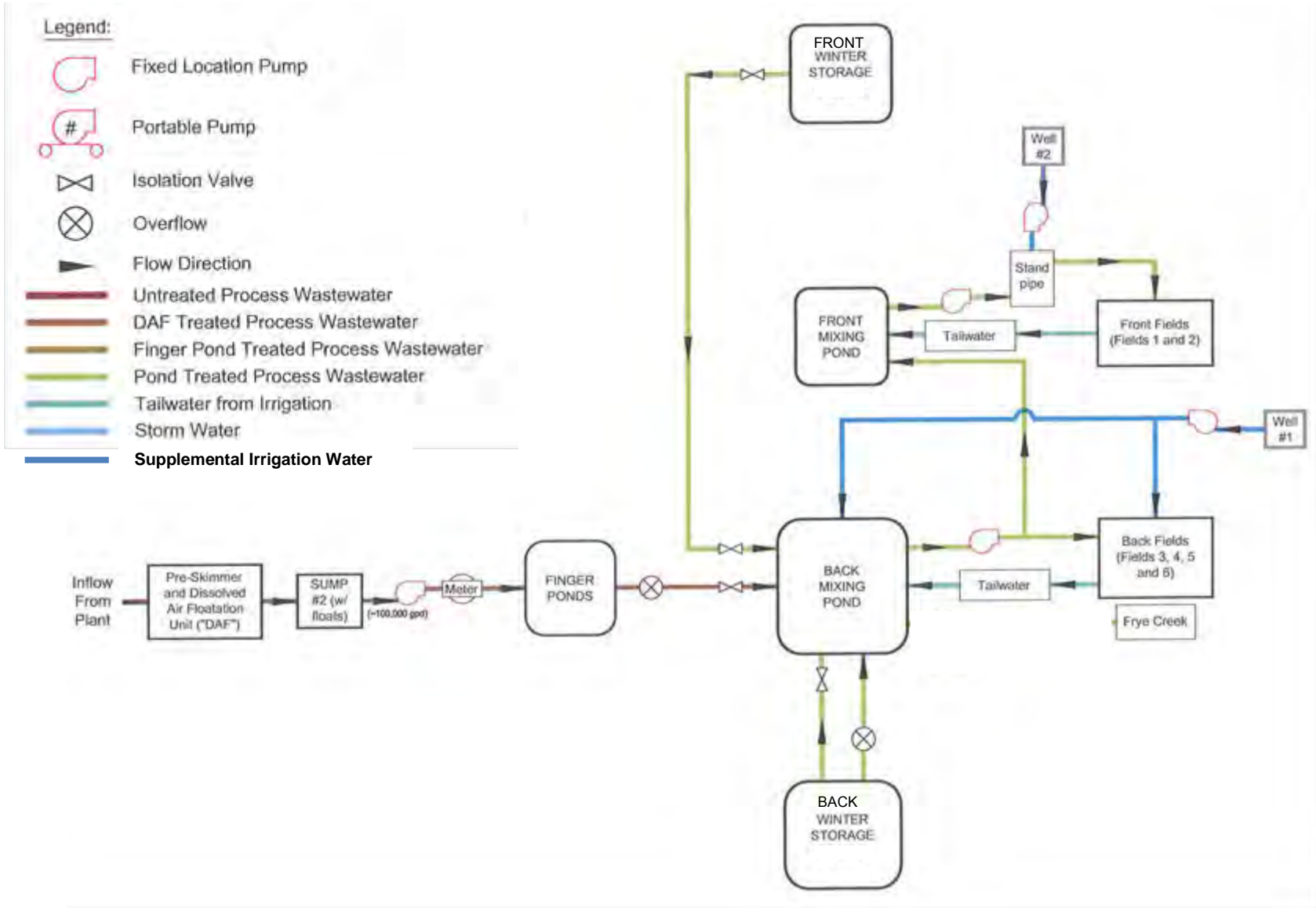

Approximate Scale
No Scale



Drawing Reference:
Report of Waste Discharge
30 November 2007

PROCESS FLOW DIAGRAM – DRY WEATHER MONTHS
SACRAMENTO RENDERING COMPANIES
RANCHO CORDOVA RENDERING PLANT
SACRAMENTO COUNTY

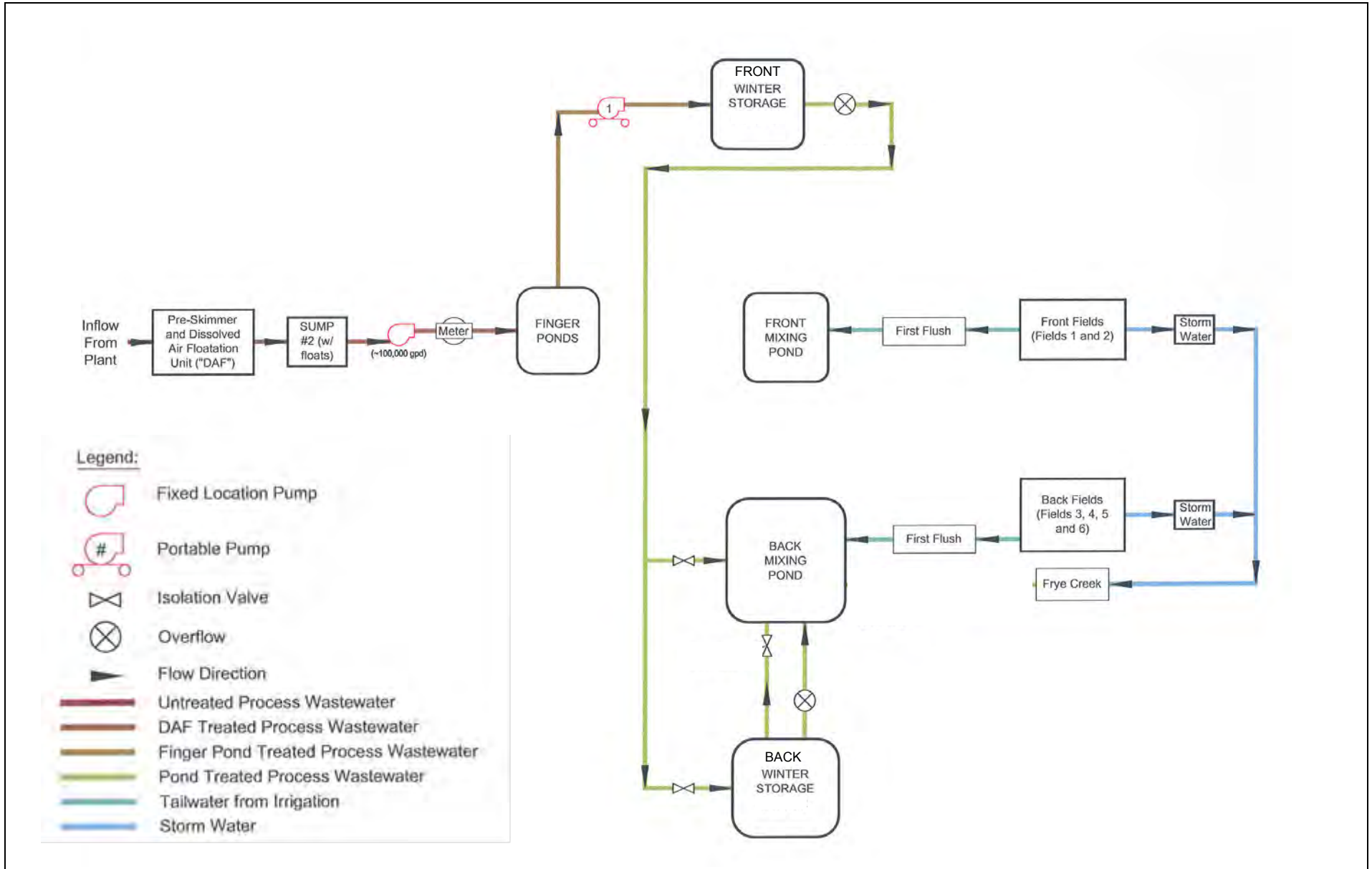

Approximate Scale
No Scale



Drawing Reference:
Report of Waste Discharge
30 November 2007

PROCESS FLOW DIAGRAM – WET WEATHER MONTHS
SACRAMENTO RENDERING COMPANIES
RANCHO CORDOVA RENDERING PLANT
SACRAMENTO COUNTY

ATTACHMENT F
REQUIREMENTS FOR MONITORING WELL INSTALLATION WORKPLANS AND
MONITORING WELL INSTALLATION REPORTS

Prior to installation of groundwater monitoring wells, the Discharger shall submit a workplan containing, at a minimum, the information listed in Section 1, below. Wells may be installed after staff approves the workplan. Upon installation of the monitoring wells, the Discharger shall submit a well installation report which includes the information contained in Section 2, below. All workplans and reports must be prepared under the direction of, and signed by, a registered geologist or civil engineer licensed by the State of California.

SECTION 1 - Monitoring Well Installation Workplan and
Groundwater Sampling and Analysis Plan

The monitoring well installation workplan shall contain the following minimum information:

A. General Information:

- Purpose of the well installation project
- Brief description of local geologic and hydrogeologic conditions
- Proposed monitoring well locations and rationale for well locations
- Topographic map showing facility location, roads, and surface water bodies
- Large scaled site map showing all existing on-site wells, proposed wells, surface drainage courses, surface water bodies, buildings, waste handling facilities, utilities, and major physical and man-made features

B. Drilling Details:

- On-site supervision of drilling and well installation activities
- Description of drilling equipment and techniques
- Equipment decontamination procedures
- Soil sampling intervals (if appropriate) and logging methods

C. Monitoring Well Design (in narrative and/or graphic form):

- Diagram of proposed well construction details
 - Borehole diameter
 - Casing and screen material, diameter, and centralizer spacing (if needed)
 - Type of well caps (bottom cap either screw on or secured with stainless steel screws)
 - Anticipated depth of well, length of well casing, and length and position of perforated interval
 - Thickness, position and composition of surface seal, sanitary seal, and sand pack
 - Anticipated screen slot size and filter pack

D. Well Development (not to be performed until at least 48 hours after sanitary seal placement):

- Method of development to be used (i.e., surge, bail, pump, etc.)
- Parameters to be monitored during development and record keeping technique
- Method of determining when development is complete
- Disposal of development water

- E. Well Survey (precision of vertical survey data shall be at least 0.01 foot):
Identify the Licensed Land Surveyor or Civil Engineer that will perform the survey
Datum for survey measurements
List well features to be surveyed (i.e. top of casing, horizontal and vertical coordinates, etc.)
- F. Schedule for Completion of Work
- G. Appendix: Groundwater Sampling and Analysis Plan (SAP)
The Groundwater SAP shall be included as an appendix to the workplan, and shall be utilized as a guidance document that is referred to by individuals responsible for conducting groundwater monitoring and sampling activities.
- H. Provide a detailed written description of standard operating procedures for the following:
- Equipment to be used during sampling
 - Equipment decontamination procedures
 - Water level measurement procedures
 - Well purging (include a discussion of procedures to follow if three casing volumes cannot be purged)
 - Monitoring and record keeping during water level measurement and well purging (include copies of record keeping logs to be used)
 - Purge water disposal
 - Analytical methods and required reporting limits
 - Sample containers and preservatives
 - Sampling
 - o General sampling techniques
 - o Record keeping during sampling (include copies of record keeping logs to be used)
 - o QA/QC samples
 - Chain of Custody
 - Sample handling and transport

SECTION 2 - Monitoring Well Installation Report

The monitoring well installation report must provide the information listed below. In addition, the report must also clearly identify, describe, and justify any deviations from the approved workplan.

A. General Information:

- Purpose of the well installation project
- Brief description of local geologic and hydrogeologic conditions encountered during installation of the wells
- Number of monitoring wells installed and copies of County Well Construction Permits
- Topographic map showing facility location, roads, surface water bodies
- Scaled site map showing all previously existing wells, newly installed wells, surface water bodies, buildings, waste handling facilities, utilities, and other major physical and man-made features.

B. Drilling Details (in narrative and/or graphic form):

- On-site supervision of drilling and well installation activities
- Drilling contractor and driller's name
- Description of drilling equipment and techniques
- Equipment decontamination procedures
- Soil sampling intervals and logging methods
- Well boring log
 - Well boring number and date drilled
 - Borehole diameter and total depth
 - Total depth of open hole (same as total depth drilled if no caving or back-grouting occurs)
 - Depth to first encountered groundwater and stabilized groundwater depth
 - Detailed description of soils encountered, using the Unified Soil Classification System

C. Well Construction Details (in narrative and/or graphic form):

- Well construction diagram, including:
 - Monitoring well number and date constructed
 - Casing and screen material, diameter, and centralizer spacing (if needed)
 - Length of well casing, and length and position of perforated interval
 - Thickness, position and composition of surface seal, sanitary seal, and sand pack
 - Type of well caps (bottom cap either screw on or secured with stainless steel screws)

E. Well Development:

- Date(s) and method of development
- How well development completion was determined
- Volume of water purged from well and method of development water disposal
- Field notes from well development should be included in report

- F. Well Survey (survey the top rim of the well casing with the cap removed):
- Identify the coordinate system and datum for survey measurements
 - Describe the measuring points (i.e. ground surface, top of casing, etc.)
 - Present the well survey report data in a table
 - Include the Registered Engineer or Licensed Surveyor's report and field notes in appendix.