

# Guidelines and Standard Procedures for Continuous Water-Quality Monitors: Station Operation, Record Computation, and Data Reporting



Techniques and Methods 1–D3

**Front Cover.** Upper left—South Fork Peachtree Creek at Johnson Road near Atlanta, Georgia, site 02336240 (*photograph by Craig Oberst, USGS*)  
Center—Lake Mead near Sentinel Island, Nevada, site 360314114450500 (*photograph by Ryan Rowland, USGS*)  
Lower right—Pungo River at channel light 18, North Carolina, site 0208455560 (*photograph by Sean D. Egen, USGS*)

**Back Cover.** Lake Mead near Sentinel Island, Nevada, site 360314114450500 (*photograph by Ryan Rowland, USGS*)

# **Guidelines and Standard Procedures for Continuous Water-Quality Monitors: Station Operation, Record Computation, and Data Reporting**

By Richard J. Wagner, Robert W. Boulger, Jr., Carolyn J. Oblinger, and Brett A. Smith

Techniques and Methods 1–D3

**U.S. Department of the Interior**  
**U.S. Geological Survey**

**U.S. Department of the Interior**  
P. Lynn Scarlett, Acting Secretary

**U.S. Geological Survey**  
P. Patrick Leahy, Acting Director

U.S. Geological Survey, Reston, Virginia: 2006

For product and ordering information:

World Wide Web: <http://www.usgs.gov/pubprod>

Telephone: 1-888-ASK-USGS

For more information on the USGS—the Federal source for science about the Earth, its natural and living resources, natural hazards, and the environment:

World Wide Web: <http://www.usgs.gov>

Telephone: 1-888-ASK-USGS

Any use of trade, product, or firm names is for descriptive purposes only and does not imply endorsement by the U.S. Government.

Although this report is in the public domain, permission must be secured from the individual copyright owners to reproduce any copyrighted materials contained within this report.

Suggested citation:

Wagner, R.J., Boulger, R.W., Jr., Oblinger, C.J., and Smith, B.A., 2006, Guidelines and standard procedures for continuous water-quality monitors—Station operation, record computation, and data reporting: U.S. Geological Survey Techniques and Methods 1–D3, 51 p. + 8 attachments; accessed April 10, 2006, at <http://pubs.water.usgs.gov/tm1d3>

## Contents

Abstract.....	1
Introduction.....	1
Purpose and Scope .....	1
Acknowledgments .....	2
Water-Quality Monitoring Station Operation .....	2
Site Selection.....	2
Monitor Selection .....	5
Monitor Configurations and Sensors .....	5
Types of Sensors.....	5
Temperature.....	7
Specific Conductance.....	7
Salinity .....	8
Dissolved Oxygen .....	8
Percentage of Dissolved Oxygen Saturation .....	8
pH .....	9
Turbidity .....	9
Instrument Acceptance Criteria.....	10
Placement of Sensors in the Aquatic Environment .....	10
Stream Cross-Section Surveys .....	10
Lake or Estuary Vertical Profiles .....	11
Use and Calibration of Field Meters .....	11
Temperature.....	11
Specific Conductance.....	11
Dissolved Oxygen.....	11
pH .....	12
Turbidity .....	12
Monitor Operation and Maintenance.....	12
Standard Protocol.....	13
Maintenance.....	13
Sensor Inspection and Calibration Check .....	14
Steady-State Conditions .....	14
Rapidly Changing Conditions .....	14
Alternative Methods for Servicing a Monitor .....	16
Monitor Calibration Criteria .....	16
Field Cleaning of Sensors.....	17
Field Calibration of Sensors .....	17
Temperature Sensors.....	18
Specific Conductance Sensors.....	18
Dissolved Oxygen Sensors.....	18
pH Sensors.....	19
Turbidity Sensors .....	20
Troubleshooting Procedures.....	20
Requirements for Field Notes and Instrument Logs .....	22
Record Computation.....	22

Data-Processing Procedures .....	23
Initial Data Evaluation .....	23
Application of Data Corrections .....	24
Corrections for Fouling .....	31
Corrections for Calibration Drift .....	33
Other Corrections .....	35
Evaluation of Cross-Section Data Corrections .....	35
Computation of Salinity .....	36
Computation of Percentage of Dissolved Oxygen Saturation .....	37
Final Data Evaluation .....	37
Maximum Allowable Limits for Reporting Continuous Data .....	37
Publication Criteria .....	38
Preparation of the Review Package .....	39
Record Checking .....	39
Station Description .....	39
Station Analysis .....	40
Documentation .....	40
Level of Review Required .....	41
Contents of the Review Package .....	41
Data Reporting .....	45
Data Reports .....	45
Data-Qualification Statements .....	47
Reporting Parameter Codes and Units .....	47
Archiving of Records .....	48
Summary .....	49
References .....	49
Attachments .....	53

## Figures

1. Photograph of Light 5 on the Pamlico River near Bath, North Carolina, and schematic of in-situ water-quality monitoring station .....	3
2. Photograph of Ramapo River at Pompton Lakes, New Jersey, and schematic of flow-through water-quality monitoring station .....	4
3. Photograph of Delaware River and Araitan Canal feeder at Raven Rock, New Jersey, and schematic of internal-logging water-quality monitoring sensor and recording system .....	7
4. Example of rapidly changing recorded values of specific conductance at U.S. Geological Survey streamgaging station 02300554, Little Manatee River at Shell Point near Ruskin, Florida .....	15
5. Specific conductance record at Duwamish River at Tukwila, Washington, September 5–10, 1998, was truncated at 330 microsiemens per centimeter, which was the default maximum setting for the data logger .....	23
6. Turbidity values at the Little Arkansas River at Highway 50 near Halstead, Kansas, October 2003 .....	24

7.	Turbidity values at the North Fork Ninescah River above Cheney Reservoir, Kansas, October 2004.....	25
8.	Example of fouling of specific conductance sensor.....	26
9.	Example of a constant data correction of –1.4 degrees Celsius applied in September 2005 to correct for programming error that produced an incorrect offset at South Fork Tolt River near Carnation, Washington .....	27
10.	Linearity of specific conductance sensor response, Palouse River at Hooper, Washington, September 10, 2002, showing best-fit regression .....	29
11.	Graphic representation of a three-point data correction for nonlinear calibration drift.....	30
12.	Data corrections for fouling of a specific conductance sensor at Palouse River at Hooper, Washington, May–June 2002.....	32
13.	Two-point variable data correction for calibration drift of a specific conductance sensor at Palouse River at Hooper, Washington, August–September 2002.....	34
14.	Two-point variable data correction for calibration drift of a dissolved oxygen sensor at Little Arkansas River near Sedgwick, Kansas, March–April 2004.....	34
15.	Example of a review graph of measured and computed values of specific conductance at Palouse River at Hooper, Washington, August 2002.....	41
16.	Example of a discharge hydrograph at U.S. Geological Survey streamgaging station 13351000, Palouse River at Hooper, Washington .....	42
17.	Example of a review graph of computed values of related water-quality field parameters at U.S. Geological Survey streamgaging station 12121500, Puyallup River at Puyallup, Washington, August 2001 .....	42

## Tables

1.	Factors for consideration in the placement and installation of continuous water-quality monitoring systems.....	2
2.	Hydraulic conditions of the ideal gage site .....	5
3.	Principal advantages and disadvantages of continuous water-quality monitoring systems.....	6
4.	Standard protocol for the operation and maintenance of a continuous water-quality monitor.....	13
5.	General maintenance functions at a water-quality monitoring station.....	13
6.	Modified standard protocol for the operation and maintenance of a continuous water-quality monitor at a site with rapidly changing conditions .....	15
7.	Calibration criteria for continuous water-quality monitors .....	16
8.	Example of the effects of temperature on pH calibration standard solutions.....	19
9.	Troubleshooting problems with water-quality monitors .....	21
10.	Criteria for water-quality data corrections .....	25
11.	Example of a constant data correction.....	27
12.	Example of a one-point variable data correction .....	28
13.	Example of a two-point variable data correction based on percentage error .....	29
14.	Example of a three-point variable data correction for nonlinear calibration drift.....	31
15.	Rating table for conversion of specific conductance, in microsiemens per centimeter, to salinity, in practical salinity units .....	36

16.	Rating table for conversion of specific conductance, in microsiemens per centimeter, to salinity, in parts per thousand .....	37
17.	Maximum allowable limits for continuous water-quality monitoring sensors .....	37
18.	Accuracy ratings of continuous water-quality records .....	38
19.	Example of an ADAPS station analysis report.....	43
20.	Example of an ADAPS end-of-year summary report.....	44
21.	Example of an ADAPS daily-values table .....	46
22.	Example of a manuscript station description.....	47
23.	Parameter codes and reporting units for measured field parameters at water-quality monitoring sites .....	48

## Attachments

1.	U.S. Geological Survey continuous water-quality monitor field form.....	55
2.	ADAPS primary data tables: (a) example of a standard format ADAPS primary data table, and (b) example of a historical format ADAPS primary data table .....	59
3.	Output from Excel spreadsheets for data-correction calculations for temperature, specific conductance, dissolved oxygen, and pH, and a correlation test for sensor linearity .....	61
4.	Evaluation and application of a cross-section data correction.....	67
5.	Example of accuracy rating using “Expanded shifts/corrections” output: (a) “Expanded shifts/corrections” daily output, and (b) “Expanded shifts/corrections” hourly output for rating transition days, and (c) final rating of accuracy based on “Expanded shifts/corrections” output .....	69
6.	Example of a station description for the Yampa River near Maybell, Colorado.....	73
7.	Example of a station analysis for specific conductance on the Yampa River near Maybell, Colorado .....	81
8.	Calibration criteria, data-correction criteria, maximum allowable limits, and ratings of accuracy.....	83

## Conversion Factors, Definitions, Datums, and Abbreviations and Acronyms

Multiply	By	To obtain
Length		
inch (in.)	25.4	millimeter (mm)
foot (ft)	0.3048	meter (m)
mile (mi)	1.609	kilometer (km)
Flow rate		
foot per second (ft/s)	0.3048	meter per second (m/s)
cubic foot per second (ft <sup>3</sup> /s)	0.02832	cubic meter per second (m <sup>3</sup> /s)
gallon per minute (gal/min)	0.06309	liter per second (L/s)



**Temperature** in degrees Celsius (°C) may be converted to degrees Fahrenheit (°F) as follows:

$$^{\circ}\text{F} = (1.8 \times ^{\circ}\text{C}) + 32$$

**Vertical coordinates:** Unless otherwise specified, vertical coordinate information is referenced to the North American Vertical Datum of 1988 (NAVD 88).

**Horizontal coordinates:** Unless otherwise specified, horizontal (latitude and longitude) coordinate information is referenced to the North American Datum of 1983 (NAD 83).

**Specific conductance** is given in microsiemens per centimeter at 25 degrees Celsius ( $\mu\text{S}/\text{cm}$  at 25 °C).

## Abbreviations and Acronyms

AC	alternating current
ADAPS	Automated Data Processing System
CD-ROM	compact disk - read only memory
DC	direct current
DECODES	Device Conversion and Delivery System
DO	dissolved oxygen
FNU	formazin nephelometric unit
HIF	Hydrologic Instrumentation Facility
ISO	International Standards Organization
LED	light-emitting diode
mg/L	milligram per liter
NAD27	North American Datum of 1927
NAWQA	National Water-Quality Assessment Program
NFQA	National Field Quality Assurance Program
NGVD29	National Geodetic Vertical Datum of 1929
NFSS	National Field Supply Service
NIST	National Institute of Standards and Technology
NTU	nephelometric turbidity unit
NWIS	National Water Information System
PSS	Practical Salinity Scale 1978
psu	practical salinity unit
S	salinity
SDVB	styrene divinylbenzene
USEPA	U.S. Environmental Protection Agency
USGS	U.S. Geological Survey
±	plus or minus
>	greater than
≥	greater than or equal to



# Guidelines and Standard Procedures for Continuous Water-Quality Monitors: Station Operation, Record Computation, and Data Reporting

By Richard J. Wagner, Robert W. Boulger, Jr., Carolyn J. Oblinger, and Brett A. Smith

## Abstract

The U.S. Geological Survey uses continuous water-quality monitors to assess the quality of the Nation's surface water. A common monitoring-system configuration for water-quality data collection is the four-parameter monitoring system, which collects temperature, specific conductance, dissolved oxygen, and pH data. Such systems also can be configured to measure other properties, such as turbidity or fluorescence. Data from sensors can be used in conjunction with chemical analyses of samples to estimate chemical loads. The sensors that are used to measure water-quality field parameters require careful field observation, cleaning, and calibration procedures, as well as thorough procedures for the computation and publication of final records.

This report provides guidelines for site- and monitor-selection considerations; sensor inspection and calibration methods; field procedures; data evaluation, correction, and computation; and record-review and data-reporting processes, which supersede the guidelines presented previously in U.S. Geological Survey Water-Resources Investigations Report 00-4252. These procedures have evolved over the past three decades, and the process continues to evolve with newer technologies.

## Introduction

Water quality can change frequently over time, necessitating frequent, repeated measurements to adequately characterize variations in quality. When the time interval between repeated measurements is sufficiently small, the resulting water-quality record can be considered continuous. A device that measures water quality in this way is called a continuous water-quality monitor. These monitors have sensors and recording systems to measure physical and chemical water-quality field parameters at discrete time intervals at point locations. Operation of a water-quality monitoring station provides a nearly continuous record of water quality that can be processed and published or distributed directly by

telemetry to the Internet. The water-quality record provides a nearly complete record of changes in water quality that also can serve as the basis for computation of constituent loads at a site. Data from the sensors also can be used to estimate other constituents if a significant correlation can be established, often by regression analyses.

Continuous monitoring of water-quality field parameters, such as temperature, specific conductance, pH, dissolved oxygen (DO), and turbidity, takes place in a wide variety of aquatic environments, ranging from clear, pristine, freshwater streams to biologically productive estuaries. Procedures for continuous monitoring in pristine, freshwater streams differ from those needed in coastal environments. Continuous monitoring in coastal environments can be challenging because of rapid biofouling from microscopic and macroscopic organisms, corrosion of electronic components from salt and high humidity, and wide ranges in values of field parameters associated with changing weather and tidal conditions.

Temperature and conductivity are true physical properties of water bodies, whereas DO and pH are concentrations, and turbidity is an expression of the optical properties of water (ASTM International, 2003). For the purposes of this report, all of these properties or constituents and the sensor values recorded by the monitors are referred to as field parameters. Sensors also are available to measure other field parameters, such as oxidation-reduction potential, water level, depth, ammonia, nitrate, chloride, and fluorescence. In addition to the measured field parameters, some monitors include algorithms to report calculated parameters, such as specific conductance, salinity, total dissolved solids, and percentage of DO saturation. Emerging sensor technology broadens the variety of measurable chemical constituents and reduces the limits of detection. Because it has become possible to make near real-time water-quality monitoring data available on the Internet, continual progress is being made to improve applications and refine quality-control procedures.

## Purpose and Scope

This report provides basic guidelines and procedures for use by U.S. Geological Survey (USGS) personnel in site and

water-quality monitor selection, field procedures, calibration of continuous water-quality monitors, record computation and review, and data reporting. Two techniques for servicing continuous monitors are discussed in this report: (1) a method for servicing monitors in a well-mixed, stable, or slowly changing aquatic environment; and (2) a method for servicing monitors in a dynamic, rapidly changing aquatic environment as is commonly found in estuaries. A discussion of alternative methods for servicing monitors also is included. These basic guidelines are minimal requirements that may need to be modified to meet local environmental conditions. Knowledge of the operation of the monitoring equipment and first-hand knowledge of the watershed form the core of the data-evaluation process. Record-computation procedures presented in this report provide a uniform set of minimum requirements for computing records. Examples of the application of scientific judgment in the evaluation of data records are discussed and are, by necessity, site specific. Other specific examples also are included to demonstrate the range of environmental conditions that affect the evaluation process.

### Acknowledgments

The authors appreciate the support, technical contributions, and advice of USGS colleagues in the preparation of this document. The authors wish to thank Janice Ward, Yvonne Stoker, Jacob Gibs, Andrew Ziegler, Heather Heckathorn, Marlene Sanderson, and Stephen Schmitt for their diligent technical reviews of the manuscript. Many others contributed to the content of this report. Special thanks to Trudy Bennett for her assistance in review of the record computation sections; to Kevin Grimsley for his assistance with the salinity computation section; and to Jerad Bales, Wendi Young, and Kathy Sarver for their assistance with the program for calculating percentage of DO saturation. The authors are grateful for the encouragement and support from the USGS Office of Water Quality, particularly from Steve Sorenson, Tim Miller, Kathy Fitzgerald, and Franceska Wilde.

## Water-Quality Monitoring Station Operation

Physical and chemical measurements made in streams at frequent, discrete intervals provide a nearly continuous record of water quality in an aquatic environment. Major considerations in the design of a continuous water-quality monitoring station include selection of the monitor configuration, types of monitors and sensors, site selection, locations of the sensors in the aquatic environment, the use and calibration of field meters, and the actual operation of continuous water-quality monitors. Sensor and site selection are guided by the purpose of monitoring and the data objectives. The main objective in

the placement of the sensors is the selection of a stable, secure location that is representative of the aquatic environment.

### Site Selection

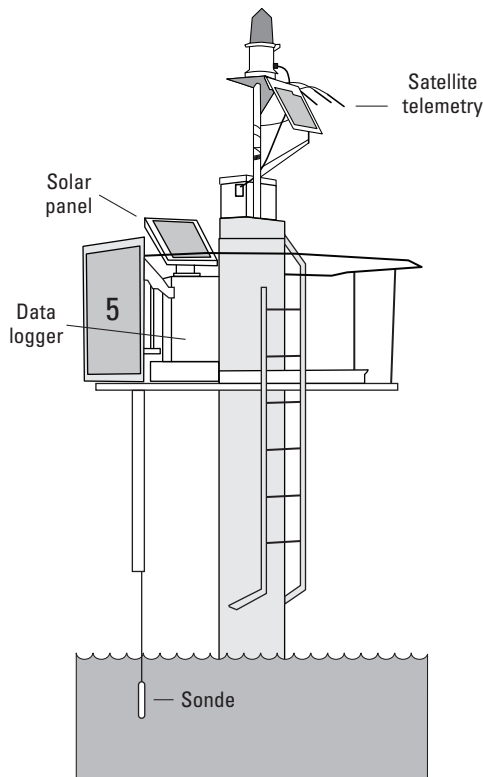
The main factors to consider in selecting a water-quality monitoring site are the purpose of monitoring and the data-quality objectives. All other factors used in the site-selection process must be balanced against these two key factors. Defining the purpose of monitoring includes making decisions about the field parameters to be measured, the period and duration of monitoring, and the frequency of data collection. Stream characteristics, site characteristics, and data-quality objectives determine whether a data sonde will be placed in situ (fig. 1) or whether a flow-through receptacle with a pumping sampler (fig. 2) will be a better choice. More site-specific considerations in monitor placement include site-design requirements, monitor-installation type, physical constraints of the site, and servicing requirements (table 1).

**Table 1.** Factors for consideration in the placement and installation of continuous water-quality monitoring systems.

<b>Site characteristics</b>
Potential for water-quality measurements at the site to be representative of the location being monitored. Degree of cross-section variation and vertical stratification. A channel configuration that may pose unique constraints. Range of stream stage (from low flow to flood) that can be expected. Water velocity. Presence of turbulence that will affect water-quality measurements. Conditions that may enhance the rate of fouling, such as excessive fine sediments, algae, or invertebrates. Range of values for water-quality field parameters. Need for protection from high-water debris damage. Need for protection from vandalism.
<b>Monitor installation</b>
Type of state or local permits required before installation can begin. Safety hazards relevant to monitor construction and installation. Optimal type and design of installation. Consideration of unique difficulties or costs of installation.
<b>Logistics (maintenance requirements)</b>
Accessibility of site, including parking or boat access. Safe and adequate space in which to perform maintenance. Presence of conditions that increase the frequency of servicing intervals needed to meet data-quality objectives. For stream sites, proximity to an adequate location for making cross-section measurements. Accessibility and safety of the site during extreme events (for example, floods or high winds). Availability of electrical power or telephone service. Need for real-time reporting.



Sean Egen, U.S. Geological Survey



**Figure 1.** Light 5 on the Pamlico River near Bath, North Carolina, and schematic of in-situ water-quality monitoring station.

Once the purposes of monitoring and data-quality objectives are defined, balancing the numerous considerations for placement of a continuous water-quality monitoring system still can be difficult. Obtaining measurements representative of the water body usually is an important data-quality objective. The optimum site consideration for achieving this objective is placing the pump intake, sensor package, or sonde in a location that best represents the water body being measured. Thus, an optimal site is one that permits sensors to be located at a point that best represents the section of interest for the aquatic environment being monitored.

For streams, cross-section surveys of field parameters must be made to determine the most representative location for monitor placement. A site must not be selected without first determining that the data-quality objective for cross-section variability will be met. Sufficient measurements must be made at the cross section to determine the degree of mixing at the prospective site under different flow conditions and to verify that cross-section variability at the site does not exceed that needed to meet data-quality objectives. Additional cross-section measurements must be made after equipment installation to ensure that the monitor installation is representative of the stream during all seasons and hydrographic flow conditions.

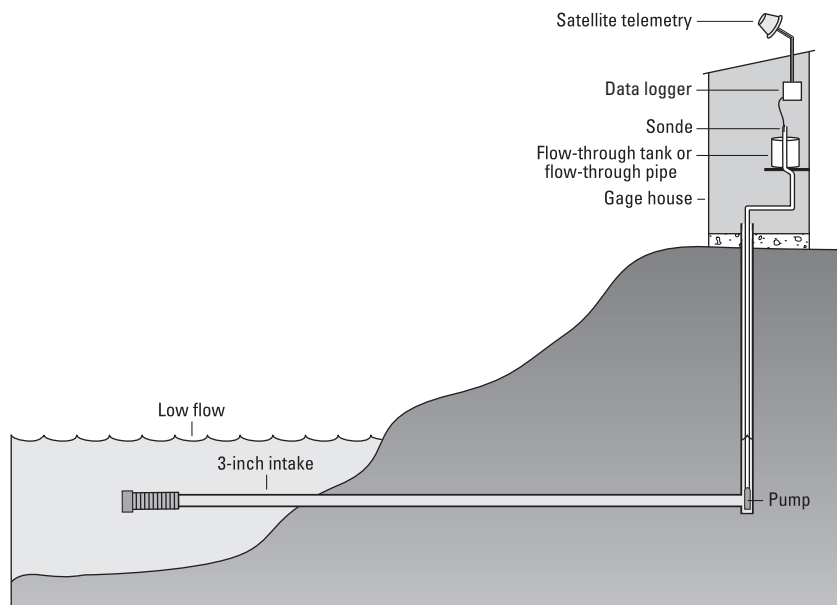
Water-quality characteristics in lakes, bays, estuaries, or coastal waters also may be variable, making it difficult to find a single location that is representative of the entire water body. Sufficient measurement surveys of field parameters must be made to provide adequate confidence that the magnitude and spatial distribution of variability are understood. Vertical-profile surveys should be made in lakes, deep rivers, or estuaries. If substantial horizontal or vertical variability is determined, consideration should be given to choosing another site with less vertical or horizontal variability, or using a different approach to meet the data-quality objectives (see *Placement of Sensors in the Aquatic Environment*). For example, estuaries, lakes, or large rivers may be chemically or thermally stratified. Sensors or pump intakes at multiple depths may be a solution for providing adequate data in stratified bodies of water. Multiple sensors or multiple pump intakes for a flow-through monitoring system may be needed to meet the monitoring and data-quality objectives for measuring field parameters in deep lakes, estuarine sites, or other vertically stratified sites.

The best location for a monitoring site is often one that is best for measuring surface-water discharge. Although hydraulic factors in site location must be considered, it is more important to consider factors that affect water-quality conditions. The same hydraulic factors that must be considered when selecting a specific site for measuring discharge in a channel also should be considered in selecting a water-quality monitoring location. Both purposes require a representative site that approaches uniform conditions across the entire width of the stream. Rantz and others (1982) identified nine





Michael J. Deluca, U.S. Geological Survey



**Figure 2.** Ramapo River at Pompton Lakes, New Jersey, and schematic of flow-through water-quality monitoring station.

hydraulic conditions for an ideal gage site, and these also must be considered in site selection for water-quality sites (table 2).

Some aquatic environments may present unique challenges for optimal site location. Lateral mixing in large rivers often is not complete for tens of miles downstream from a tributary or outfall. Turbulent streamflow may aid in mixing, but turbulence can create problems in monitoring field parameters, such as DO or turbidity. A location near the streambank may be more representative of local runoff or affected by point-source discharges upstream, whereas a

location in the channel center may be more representative of areas farther upstream in the drainage basin. Large streams and rivers usually are monitored from the downstream side of bridge abutments, assuming that safety hazards and other difficulties can be reduced or overcome.

The measurement point in the vertical dimension of larger flow systems also needs to be appropriate for the primary purpose of the monitoring installation. The vertical measurement point can be chosen for low-, medium-, or high-flow conditions; if bed movement or sensor location during low flow is a problem, consideration should be given to moving the sensors along the bridge to the optimal location. For a medium to small stream with alternating pools and riffles, the best flow and mixing occurs in the riffle portion of the stream; however, if flooding changes the locations of shoals upstream from the monitoring site, the measurement point may no longer represent the overall water-quality characteristics of the water body. Streams subject to substantial bed movement can result in the sensors being located out of water following a major streamflow event, or at a point no longer representative of the flow. A site may be ideal for monitoring high flow but not satisfactory during low flows. Site selection often is a choice of meeting as many of the applicable criteria as possible.

Assessment of a site also is dependent on fouling potential, ease of access, susceptibility to vandalism, and susceptibility of instruments or telemetry to interference from high-tension power lines or radio towers. The configuration and placement of water-quality monitoring sensors in cold regions require additional considerations in order to obtain data during periods of ice formation. White (1999) discusses environmental factors in the site selection of an automated water-quality station in British Columbia, Canada, but also generalizes morphological stream factors and the importance of selecting a site that has minimal chance of damage or destruction from natural forces and vandalism. White (1999) emphasizes that a site should (1) meet minimum stream-depth requirements for instruments, (2) be safe and accessible under all conditions, and (3) be located to avoid the danger of vandalism. Also emphasized is exposure to direct sunlight if optical sensors are deployed. White (1999) adds that sites should be selected based on program objectives and field reconnaissance under several flow conditions.

**Table 2.** Hydraulic conditions of the ideal gage site (modified from Rantz and others, 1982).

1. The general course of the stream is straight for about 300 feet upstream and downstream from the gage site.
2. The total flow is confined to one channel at all stages, and no flow bypasses the site as subsurface flow.
3. The streambed is not subject to scour and fill, and is free of aquatic growth.
4. Banks are permanent, high enough to contain flood waters, and free of brush.
5. Unchanging natural controls are present in the form of a bedrock outcrop or other stable riffle for low flow and a channel constriction for high flow, or a falls or cascade that is not submerged at all stages.
6. A pool is present upstream from the control at extremely low stages to ensure a recording stage at extremely low flow, and to avoid high velocities at the streamward end of gaging-site intakes during periods of high flow.
7. The gaging site is far enough upstream from a confluence with another stream or from tidal effect to avoid any variable influence on stage at the gage site from the other stream or tide.
8. A satisfactory reach for measuring discharge at all stages is available within reasonable proximity of the gage site. (It is not necessary that low and high flows be measured at the same stream cross section.)
9. The site is readily accessible for ease of installation and operation of the gaging station.
10. The site is not susceptible to manmade disturbances, nearby tributaries, or point-source discharges.

## Monitor Selection

The selection of a water-quality monitor involves four major interrelated elements—(1) the purpose of the data collection, (2) the type of installation, (3) the type of sensor deployed at the installation, and (4) the specific sensors needed to satisfy the accuracy and precision requirements of the data-quality objectives.

Sensors are available as individual instruments or as a single combined instrument that has several different sensors in various combinations. For clarity in this report, a sensor is the fixed or detachable part of the instrument that measures a particular field parameter. A group of sensors configured together commonly is referred to as a sonde. A sonde typically has a single recording unit or electronic data logger to record the output of multiple sensors. The term monitor refers to the combination of sensor(s) and the recording unit or data logger. The most widely used water-quality sensors in monitoring installations are temperature, conductivity, DO, pH, and turbidity. These sensors are the focus of this report.

## Monitor Configurations and Sensors

In general, three types of configurations are used for water-quality monitors. Each configuration has advantages and disadvantages in relation to site location and data-quality objectives. The flow-through monitoring system has a pump that delivers water from the measuring point to the sensor(s) or sonde housed in a shelter (fig. 2). Typical pumps for a flow-through monitoring system require 110-volt alternating current (AC) and pump about 10 gallons of water per minute. Access to power is a requirement for flow-through monitoring systems, but advantages and disadvantages of all of the monitoring configurations must be evaluated based on the monitoring objectives (table 3).

The second configuration is one in which only the sensors are placed directly at the measuring point (in situ)

in the aquatic environment, and communication cables are run to the data logger and power system located in a water-resistant shelter (fig. 1). The primary advantages of the in-situ configuration are that no power is needed to pump water, small shelters can be used, and systems can be installed at remote locations where AC power is not available (table 3). Direct current (DC), 12-volt batteries easily meet the power requirements of the sensors and recording equipment, and solar panels may suffice in some areas.

The third type of water-quality monitoring system is an internal-logging, combined sensor and recording sonde that is entirely immersed and requires no external power, thus reducing its exposure to vandalism (fig. 3). Power is supplied by conventional batteries located in a sealed compartment, and sensor data are stored within the sonde on nonvolatile, flash-memory, recording devices. The primary advantages of the internal-logging configuration are that AC power or large batteries and shelters are not needed.

## Types of Sensors

Sensors are available for continuous measurement of many field parameters and chemical constituents, but five of the most commonly used sensors are temperature, specific conductance, DO, pH, and turbidity. General concepts and calibration procedures are described in this report, but manufacturers' instructions and recommendations should be read carefully and followed. Although the concepts of monitor operation and record computation also apply to other types of sensors, insufficient information is available to specify calibration criteria, data-correction criteria, and maximum allowable limits for sensors measuring other field parameters (see *Application of Data Corrections*). If a sensor is used for which these criteria have not been specified, sufficient quality-assurance data must be collected to define and apply quality-control limits. This information should be documented in a quality-assurance plan.

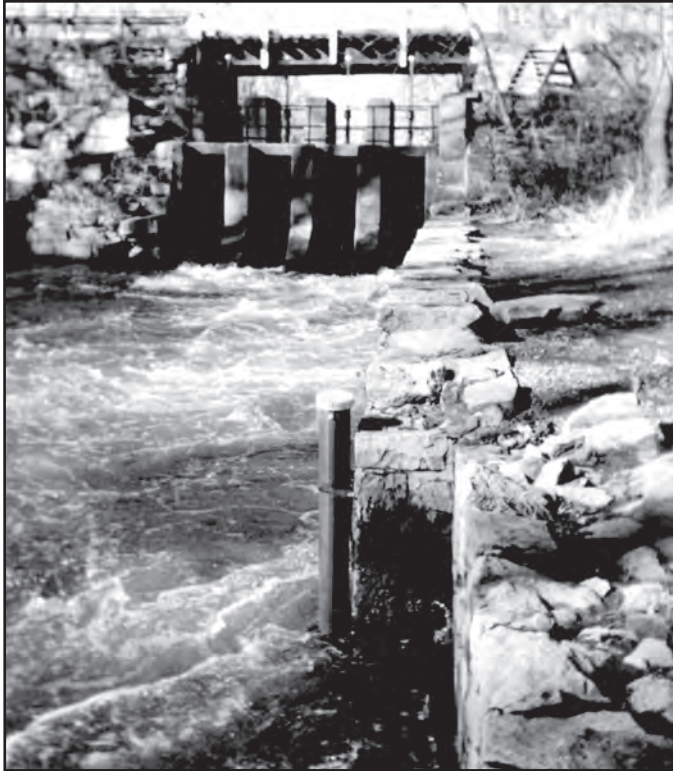
## 6 Guidelines and Standard Procedures for Continuous Water-Quality Monitors: Operation, Record Computation, and Data

**Table 3.** Principal advantages and disadvantages of continuous water-quality monitoring systems.

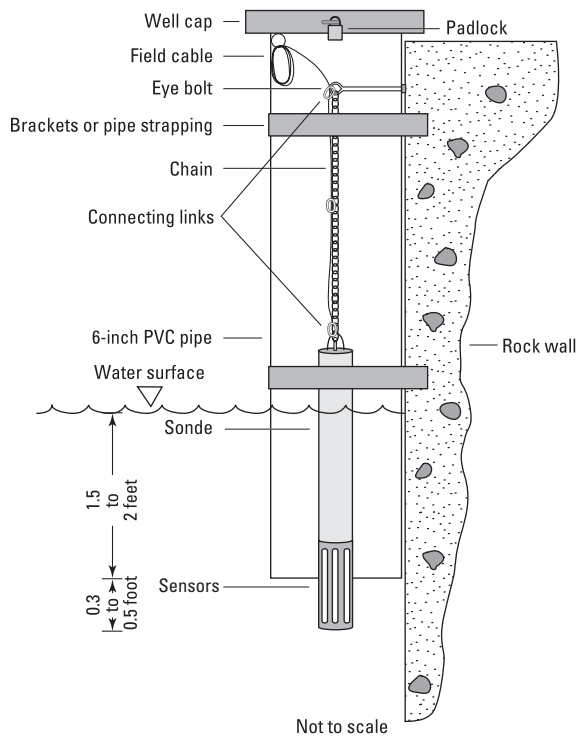
[AC, alternating current]

Advantages	Disadvantages
<b>Flow-through monitoring system</b>	
<p>Unit can be coupled with chlorinators to reduce membrane fouling.</p> <p>Expensive sensor systems can be secured in vandal-proof shelters.</p> <p>Calibration can be performed in the shelter.</p> <p>Sample water from more than one measuring point can be pumped to a single set of sensors.</p> <p>With satellite telemetry, data can be transmitted to an office location.</p> <p>System can be monitored remotely for problems and needed service.</p> <p>Freeze protection can be provided to the sensors.</p>	<p>110-volt AC power source is needed.</p> <p>Large shelters are required, incurring higher installation costs.</p> <p>Pumps in streams can clog from algal fouling or high sediment loads.</p> <p>In shallow bank or poorly mixed installations, properly locating intakes or sensors in the cross section is difficult.</p> <p>Electrical shock protection is required.</p> <p>Pumps may be damaged by sediment or corrosive waters.</p> <p>Pump maintenance may be necessary.</p> <p>Pumping may cause changes in water quality.</p>
<b>In-situ monitoring system</b>	
<p>Remote locations are possible.</p> <p>Small shelters can be used.</p> <p>No power is needed to pump water, and electrical hazards are reduced.</p> <p>With satellite telemetry, data can be transmitted to an office location.</p> <p>System can be monitored remotely for problems and needed service.</p> <p>Pump maintenance is not necessary.</p>	<p>Sensors are susceptible to vandalism.</p> <p>Sensors are more prone to fouling than in a flow-through system.</p> <p>Servicing sensors during flooding can be difficult.</p> <p>In shallow bank or poorly mixed installations, properly locating intakes or sensors in the cross section is difficult.</p> <p>Sensors are susceptible to debris or high flow.</p> <p>Shifting channels may require adjustments to sensor placement.</p> <p>Susceptible to freezing.</p>
<b>Internal-logging monitoring system</b>	
<p>Location options are flexible.</p> <p>No electrical hazards.</p> <p>Exposure to vandalism may be reduced.</p> <p>Pump maintenance is not necessary.</p>	<p>Sensors are susceptible to vandalism.</p> <p>Sensors are more prone to fouling than in a flow-through system.</p> <p>Servicing sensors during flooding can be difficult.</p> <p>In shallow bank or poorly mixed installations, properly locating intakes or sensors in the cross section is difficult.</p> <p>Data are available only during site visits.</p> <p>Sensors are susceptible to debris or high flow.</p> <p>Shifting channels may require adjustments to sensor placement.</p> <p>Status of the equipment can only be checked while servicing.</p> <p>Data cannot be viewed without a site visit, and loss of data is unknown until a site visit.</p> <p>Susceptible to freezing.</p>





Bonnie Gray, U.S. Geological Survey



**Figure 3.** Delaware River and Araitan Canal feeder at Raven Rock, New Jersey, and schematic of internal-logging water-quality monitoring sensor and recording system.

### Temperature

Temperature affects the density of water, the solubility of constituents (such as oxygen in water), pH, specific conductance, the rate of chemical reactions, and biological activity in water (Radtke and others, 2004). Continuous water-quality sensors usually measure temperature with a thermistor, which is a semiconductor having resistance that changes with temperature. Thermistors are reliable, accurate, and durable temperature sensors that require little maintenance and are relatively inexpensive. The preferred water-temperature scale for most scientific work is the Celsius scale. Modern thermistors can measure temperature to plus or minus ( $\pm$ ) 0.1 degree Celsius ( $^{\circ}\text{C}$ ), but the user must verify the accuracy claimed by the manufacturer for the range of application.

### Specific Conductance

Electrical conductivity is a measure of the capacity of water to conduct an electrical current and is a function of the types and quantities of dissolved substances in water (Radtke and others, 2005). As concentrations of dissolved ions increase, conductivity of the water increases. Specific conductance is the conductivity expressed in units of microsiemens per centimeter. The USGS measures and reports specific conductance in microsiemens per centimeter at 25  $^{\circ}\text{C}$  ( $\mu\text{S}/\text{cm}$  at 25  $^{\circ}\text{C}$ ). Specific conductance measurements are a good surrogate for total dissolved solids and total ion concentrations, but there is no universal linear relation between total dissolved solids and specific conductance. Rather, the relation between specific conductance and constituent concentration must be determined for each site. A continuous record of specific conductance can be used in conjunction with chemical analyses and continuous discharge records to estimate constituent loads (Clifton and Gilliom, 1989; Hill and Gilliom, 1993; Christensen and others, 2000).

Specific conductance sensors generally are of two types—contact sensors with electrodes and sensors without electrodes. Continuous specific conductance sensors generally have electrodes that require the user to choose a cell constant for the expected range of specific conductance. Multiparameter monitoring systems should contain automatic temperature compensation circuits to compensate specific conductance to 25  $^{\circ}\text{C}$ . This should be verified by checking the manufacturer’s instruction manual. All modern sensors are designed to measure specific conductance in the range of 0–2,000  $\mu\text{S}/\text{cm}$  or higher. In general, specific conductance sensors are reliable, accurate, and durable but are susceptible to fouling from aquatic organisms and sediment.

## Salinity

Although salinity is not measured directly, some sondes include the capability of calculating and recording salinity based on conductivity measurements. Conductivity has long been a tool for estimating the amount of chloride, a principal component of salinity, in water (Albert, 1964). Salinity is most commonly reported using the Practical Salinity Scale 1978 (Lewis, 1980), a scale developed relative to a standard potassium-chloride solution and based on conductivity, temperature, and barometric pressure measurements (American Public Health Association, 1998). Before development of the Practical Salinity Scale (PSS), salinity was reported in parts per thousand. Salinity expressed in the PSS is a dimensionless value, although by convention, it is reported as practical salinity units. Salinity in practical salinity units is nearly equivalent to salinity in parts per thousand. Because salinity is not directly measured but is derived from conductivity, the USGS recommends that salinity data stored in the National Water Information System (NWIS) be calculated from processed specific conductance records (see *Computation of Salinity*). If specific conductance values have been compensated to 25 °C and water depths are sufficiently shallow that pressure corrections are not necessary, salinity can be calculated using the equations described by Schemel (2001).

## Dissolved Oxygen

Sources of DO in surface waters are primarily atmospheric reaeration and photosynthetic activity of aquatic plants (Lewis, 2005). DO is an important factor in chemical reactions in water and in the survival of aquatic organisms. In surface waters, DO concentrations typically range from 2 to 10 milligrams per liter (mg/L). DO saturation decreases as water temperature increases, and DO saturation increases with increased atmospheric pressure. Occasions of super saturation (greater than 100-percent DO saturation) often are related to excess photosynthetic production of oxygen by aquatic plants as a result of nutrient (nitrogen and phosphorus) enrichment, sunlight, and warm water temperatures, which often occur in lentic environments or in streams during low-flow conditions. Occasions of saturated oxygen commonly are related to cascading flow conditions, both natural and artificial. DO may be depleted by inorganic oxidation reactions or by biological and chemical processes that consume dissolved, suspended, or precipitated organic matter (Hem, 1989).

The DO solubility in saline environments is dependent on salinity as well as temperature and barometric pressure. DO in waters that have specific conductance values greater than 2,000  $\mu\text{S}/\text{cm}$  should be corrected for salinity. Most modern sensors automatically compensate for the effects of salinity or have manual compensation techniques, but this should be verified by checking the manufacturer's instruction manual.

Several new technologies are available for measuring DO concentrations, but the technology most commonly used for continuous water-quality sensors is the amperometric method, which measures DO with a temperature-compensated

polarographic membrane-type sensor. Although polarographic membrane-type sensors generally provide accurate results, they are sensitive to temperature and water velocity and are prone to fouling from algal growth and sedimentation. The measuring process consumes DO; therefore, water flow past the sensor is critical. If the water velocity at the point of measurement is less than 1 foot per second (ft/s), an automatic or manual stirring mechanism is required. Alternatively, a different technology may be used. DO sensors also can be affected by high water velocity. A complete discussion of DO calibration, measurement, and limitations can be found in Lewis (2005).

Because the permeability of the membrane and solubility of oxygen in water change as functions of temperature, it is critical that the DO sensors be temperature compensated. The Teflon® membranes of DO sensors are susceptible to fouling; the membrane and retaining ring are susceptible to loss of elasticity; and the cathode-anode measuring electrodes are susceptible to chemical alteration. Fouling of the membrane includes coating from oily or other organic substances, siltation, attachment of aquatic organisms (for example, barnacles in estuarine locations), growth of algae, or deposition of other materials. Chemical alteration of the DO electrodes can be caused by a strong oxidizing or reducing chemical agent, such as a chemical spill, by metal-rich drainage water, or by organic-rich waters, such as a wetland. A more common chemical alteration is sulfide poisoning of the anode in oceanographic or ground-water environments. Poisoning is corroborated by chronically low DO readings even after sensor membrane replacement. Sulfide poisoning is evident as a gray or black color on the silver anode. Refurbishing a poisoned anode or replacement of a damaged sensor membrane is simple but requires calibration and may eliminate the ability to distinguish calibration drift from fouling. Manufacturer's instructions must be followed in refurbishing or repairing a fouled electrode.

The newest technology for measuring DO is the luminescent sensor that is based on dynamic fluorescence quenching. This method employs measurement of light-emission characteristics of a luminescent-based reaction at the sensor-water interface (Lewis, 2005). The sensor has a light-emitting diode (LED) to illuminate a specially designed oxygen-sensitive substrate that, when excited, emits a luminescent light with a lifetime that is directly proportional to the ambient oxygen concentration. The response time of this sensor technology is fast; there are few known interferences to an unfouled sensor; there is no dependence on flow; and the sensors are claimed to have long-term stability (Alliance for Coastal Technologies, 2004).

## Percentage of Dissolved Oxygen Saturation

A common method for expressing the oxygenation of a water body is the percentage of DO saturation relative to 100 percent. DO solubility is based on ambient water temperature, atmospheric pressure, and salinity. Some DO

sensors include the capability of recording the percentage of DO saturation based on measurement or stored information on water temperature, atmospheric pressure, and salinity. DO saturation is calculated by using the equations described by Weiss (1970) and the program described in USGS Technical Memorandum 99.01 (U.S. Geological Survey, 1998) and available online at <http://water.usgs.gov/software/dotables.html>. The USGS recommends that DO percentage of saturation be calculated from fully processed and corrected continuous records of DO, temperature, and specific conductance.

## pH

The pH of an aqueous solution is controlled by inter-related chemical reactions that produce or consume hydrogen ions (Hem, 1989). The pH of a solution is a measure of the effective hydrogen-ion concentration (Radtke and others, 2003). More specifically, pH is a measure that represents the negative base-10 logarithm of hydrogen-ion activity of a solution, in moles per liter. Solutions having a pH below 7 are described as acidic, and solutions with a pH greater than 7 are described as basic or alkaline. Dissolved gases, such as carbon dioxide, hydrogen sulfide, and ammonia, appreciably affect pH. Degasification (for example, loss of carbon dioxide) or precipitation of a solid phase (for example, calcium carbonate) and other chemical, physical, and biological reactions may cause the pH of a water sample to change appreciably soon after sample collection (Radtke and others, 2003).

The electrometric pH-measurement method, using a hydrogen-ion electrode, commonly is used in continuous water-quality pH sensors. Sensors used in submersible monitors typically are combination electrodes in which a proton (H<sup>+</sup>)-selective glass-bulb reservoir is filled with an approximate pH-7 buffer. A silver wire coated with silver chloride is immersed in the internal reference electrode buffer reservoir. Protons on both sides of the glass pH electrode (media and buffer reservoir) selectively interact with the glass, setting up an external potential gradient across the outer glass membrane. Because the hydrogen-ion concentration in the internal buffer solution is constant, this external potential difference across the outer glass membrane, which is determined relative to the internal silver/silver-chloride reference electrode, is proportional to the pH of the medium. A correctly calibrated pH sensor can accurately measure pH to  $\pm 0.2$  pH unit; however, the sensor can be scratched, broken, or fouled easily. If streamflow rates are high, the accuracy of the pH measurement can be affected by streaming-potential effects (Radtke and others, 2003). The pH sensors are particularly prone to sensitivity loss (Busenberg and Plummer, 1987), which may result from a partially clogged reference electrode junction or a change in the concentration of the filling solution. The treatment for suspected sensitivity loss from sensor drift is sensor reconditioning or replacement. It is possible to distinguish between pH sensor drift and electronic drift by determining the sensor slope; however, because the correction for each is the same, it is not necessary. Detailed instructions

for the calibration and measurement of pH are described by Radtke and others (2003) and by the instrument manufacturer.

## Turbidity

Turbidity is defined as an expression of the optical properties of a sample that cause light rays to be scattered and absorbed, rather than transmitted in straight lines through a sample (ASTM International, 2003). ASTM further describes turbidity as the presence of suspended and dissolved matter, such as clay, silt, finely divided organic matter, plankton, other microscopic organisms, organic acids, and dyes. Implicit in this definition is the fact that color, either of dissolved materials or of particles suspended in the water, also can affect turbidity.

Turbidity sensors operate differently from those for temperature, specific conductance, DO, and pH, which convert electrical potentials into the measurement of the constituent of interest. Submersible turbidity sensors typically direct a light beam from a light-emitting diode into the water sample and measure the light that scatters or is absorbed by the suspended particles in the water. The sensor response is related to the wavelength of the incident light and the size, shape, and composition of the particulate matter in the water. The effect of temperature on turbidity sensors is minimal, and the software for modern sensors provides temperature compensation. Calibration and measurement of turbidity by using a submersible sensor are discussed by Anderson (2004). Sensors that are maintained and calibrated routinely should be relatively error free.

Numerous methods and instruments can be used to measure turbidity. Because different measurement technologies result in different sensor responses to the same turbidity calibrant, a set of turbidity parameter codes, method codes, and reporting units has been developed to differentiate between various instruments and methodologies (Anderson, 2004). Data from each instrument type should be stored in NWIS using parameter codes and measurement reporting units that are specific to the technology and the instrument (see *Data Reporting*). Turbidity meters should be calibrated directly rather than by comparison with another meter.

Most commercially available sensors report data in nephelometric turbidity units (NTU), with a sensor range of 0–1,000 and an accuracy of  $\pm 5$  percent or 2 NTU, whichever is greater. Some sensors can report values reliably up to about 1,500 NTU. The USGS, however, defines NTU specific to the measurement of light scatter from a white tungsten lamp with color temperature 2,200–3,000 degrees Kelvin and a light detector at 90 ( $\pm 30$ ) degrees from incident light (Anderson, 2004). Instruments with such nephelometric designs qualify for approved measurement of turbidity in drinking water by the U.S. Environmental Protection Agency (USEPA) Method 180.1 (U.S. Environmental Protection Agency, 1993). Another USEPA-approved method (GLI Method 2) for measuring the turbidity of finished drinking water is a dual-beam and dual-detector technology that compensates for color and reduces



erratic readings (U.S. Environmental Protection Agency, 1999). Field turbidity meters that are based on USEPA Method 180.1 technology will not produce the same sensor response to a 100-NTU calibrant as a submersible turbidity sensor that is based on International Standards Organization (ISO) 7027 (International Organization for Standardization, 1999) technology. Turbidity sensors for most submersible continuous water-quality sondes are based on nephelometric near-infrared wavelength technology that is compliant with ISO 7027, and data should be reported in formazin nephelometric units (FNU) as described by Anderson (2004).

## Instrument Acceptance Criteria

Independent testing to ensure accuracy and reliability is an important part of any quality-assurance program for hydrologic field instrumentation. One of the primary responsibilities of the USGS Hydrologic Instrumentation Facility (HIF) is the testing, evaluation, and documentation of instrument performance. USGS Water Science Centers are encouraged to purchase or rent instruments through the HIF when possible. Otherwise, programs or projects are required to perform the necessary steps of independent testing to ensure accuracy and reliability as stated by the instrument manufacturer (U.S. Geological Survey, 1995). Water Science Center personnel are encouraged to work with the HIF to evaluate new instrumentation and actively participate by entering, reviewing, and overseeing data in the Web-based instrument quality-assurance database, managed by the HIF (<http://1stop.usgs.gov/qa/>), and by taking corrective actions when necessary.

## Placement of Sensors in the Aquatic Environment

Placement of a water-quality monitoring sensor is dependent on the purpose of monitoring and the data-quality objectives. The data-quality objectives for the measurement of loads or flux in a stream or river generally require placement of a water-quality monitoring sensor at a location that is representative of conditions in the stream cross section. Some environments, such as lakes, estuaries, or poorly mixed streams, preclude sensor placement at one representative point, and alternative monitoring strategies must be considered. For example, multiple sensors can be located in vertically or horizontally stratified aquatic environments. Another option is the use of a flow-through monitor configuration (see *Monitor Configurations and Sensors*) with intakes located at multiple depths or horizontal locations. Alternatively, if poor mixing occurs only during particular seasons or flow conditions, sensors can be placed at the optimal location, and the rating of the accuracy of the record (see *Publication Criteria*) can be downgraded during periods of poor mixing. In all cases, it is necessary to characterize the vertical and horizontal mixing at the monitor site with measurement surveys of vertical and horizontal cross-section variability (see *Stream Cross-Section Surveys*).

## Stream Cross-Section Surveys

The data objectives for most continuous water-quality monitoring stream sites require that the sensors be placed at locations that are representative of average measurements in the stream cross sections. Before a monitoring site is installed, surveys of the cross-section variability of the field measurement(s) to be monitored are required to determine the most representative measurement point in the stream cross section and to determine if a cross-section correction is necessary. Data from cross-section surveys can be used to correct single-point measurements in poorly mixed streams to better represent the cross-section average. By choosing a monitoring site with well-mixed streamflow, however, cross-section corrections may not be needed.

A sufficient number of cross-section surveys representing different flow conditions is required to determine if discharge or seasonal changes significantly affect mixing in the cross section for the field measurement(s) to be monitored. A minimum of two cross-section surveys per year is required to verify or revise results from previous surveys. Temporal changes in cross-section variability in some streams may require more frequent surveys. Documentation of vertical mixing is required at least once per year at a minimum of two depths for all cross sections.

The most efficient means of obtaining cross-section surveys is with a calibrated multisensor sonde that can measure the same field parameters that are being recorded by the monitor. At locations with high stream velocities, it may be necessary to attach the sonde to a sounding weight. Discrete samples should not be composited for measurement of cross-section averages. The standard USGS procedure for selecting measurement points for making a cross-section survey and calculating a cross-section mean value is to divide the stream cross section into increments using either the discharge- or area-weighted method (Webb and others, 1999). Generally, measurements are needed in the centroid of a minimum of four equal-discharge increments to provide a discharge-weighted mean. These multiple measurements also establish the horizontal cross-section variability of a measured field parameter. Alternatively, middepth measurements can be made at the midpoint of equal-width increments to determine an area-weighted mean value. Generally, a minimum of 10 and a maximum of 20 equal-width increments across a large stream or river are needed to establish the area-weighted mean value and horizontal cross-sectional variability of a field parameter. Examples of both area- and discharge-weighted cross-section average calculations are given in Wilde and Radtke (2005).

Multiple vertical measurements may be needed depending on the degree of vertical mixing. If physical or chemical vertical stratification is observed, the number of vertical measurements may need to be increased from middepth to two measurements (0.2 and 0.8 of the depth) or more. Alternatively, measurements can be made at points relative to changes in field parameters, such as temperature or salinity gradients, if these are documented. If the vertical stratification is sharply

defined, the measurements across the transition zone must be more closely spaced to represent the position and degree of stratification adequately.

## Lake or Estuary Vertical Profiles

For lakes and other still waters or estuaries with wide cross sections, sensors likely cannot be placed at one location that adequately represents a cross section. Study objectives for continuous water-quality monitoring at lake or estuary sites, however, may require determination of whether measurements made at a single vertical location are representative of conditions in the vertical profile (Wilde and Radke, 2005). Thus, profiles of vertical variability of the field measurement(s) to be monitored are required before a monitoring site is installed to determine the most representative measurement point in the water column. For many of these types of sites, measurements will need to be monitored at multiple depths to meet study objectives.

The number of vertical measurements needed is dependent on the degree of vertical mixing. Measurements can be made at evenly spaced intervals (such as every 1 foot from surface to bottom) or at points relative to changes in field parameters, such as temperature or salinity gradients. If the vertical stratification is sharply defined, the measurements across the transition zone must be more closely spaced to represent the position and degree of stratification adequately.

## Use and Calibration of Field Meters

The three major uses for a field meter during servicing of a continuous water-quality monitor are (1) as a general check of reasonableness of monitor readings, (2) as an independent check of environmental changes during the service interval, and (3) to make cross-section surveys or vertical profiles in order to verify the representativeness of the location of the sonde in the aquatic environment. The field meter should not be used directly to calibrate the water-quality monitor nor in the computation of monitor records. With the exception of temperature, it is important not to give too much credence to meter-to-meter comparisons. Independent field measurements must be made before, during, and after servicing the monitor to document environmental changes during the service interval. Measurements are made at the monitoring site by locating calibrated field instruments as close to the sensor as possible and at 5-minute intervals, or more frequently if necessary.

Before site visits, all support field meters should be checked for operation and accuracy. Minimum calibration frequency for each type of meter is detailed in Anderson (2004) and Wilde and Radtke (2005). All calibrations must be recorded in instrument logbooks, along with all calibrations, measurements, results from USGS National Field Quality Assurance (NFQA) Program samples, and information about sensor replacements, instrument upgrades, or other periodic calibrations.

## Temperature

Proper certification and documentation for liquid-in-glass thermometers and thermistor thermometers are detailed in Radtke and others (2004). Thermometers must be calibrated or checked against a calibration thermometer, which is either certified by the National Institute of Standards and Technology (NIST) or certified by the manufacturer as NIST traceable (Radtke and others, 2004). Liquid-in-glass thermometers and thermistors must be accurate within  $\pm 0.2$  °C. For both thermistors and liquid-in-glass thermometers, an annual five-point calibration is required over the temperature range of 0 to 40 °C using a temperature-controlled water bath and an NIST-certified or NIST-traceable thermometer to ensure accurate temperature measurement. In addition, two-point calibration checks over the maximum and minimum expected annual temperature range must be made three or more times per year for thermistors and two or more times per year for liquid-in-glass thermometers. Calibrated thermometers and thermistors must be marked with the date of calibration.

## Specific Conductance

Proper calibration and documentation for specific conductance meters are detailed in Radtke and others (2005). Calibration and adjustments for multiparameter sensor systems are found in manufacturers' servicing manuals. Calibration standard solutions of known quality that bracket the expected full range of anticipated values are used to calibrate the specific conductance meter to the appropriate units for particular field conditions. Calibration is performed at the field site with calibration standard solutions that have been allowed to equilibrate to the temperature of the water being monitored. The USGS reports specific conductance compensated to 25 °C. Most meters have automatic temperature compensation circuits that permit readings in microsiemens per centimeter at 25 °C, but this should be verified by checking the manufacturer's instruction manual. The accuracy of the meter should be within 5 percent for specific conductance values less than or equal to 100  $\mu\text{S}/\text{cm}$ , or within 3 percent for specific conductance values greater than 100  $\mu\text{S}/\text{cm}$ . Specific conductance standards are available from the USGS National Field Supply Service (NFSS). Calibration standard solutions must be discarded after use as described by Wilde (chapters variously dated).

## Dissolved Oxygen

Proper calibration and documentation for DO meters are detailed in Lewis (2005). Calibration and adjustments for multiparameter sensor systems are provided in manufacturers' servicing manuals. The most commonly used DO sensors measure the partial pressure of DO by the flow of oxygen through a porous membrane and oxygen consumption at a cathode. The calibrated accuracy of DO meters should be

within the lesser of 5 percent or  $\pm 0.3$  mg/L. Meters must be calibrated to 100-percent DO saturation and checked with a zero DO solution to provide an indication of sensor-response linearity. Calibration of a DO meter at 100-percent oxygen saturation is made by adjusting the meter reading for air saturated with water vapor to a value obtained from a DO solubility table (<http://water.usgs.gov/software/dotables.html>; Lewis, 2005) generated from the equations of Weiss (1970). The DO solubility is based on the water temperature, the uncorrected barometric pressure, and salinity. A reliable pocket altimeter can be used to measure uncorrected (true) barometric pressure to the nearest 1 millimeter (mm) of mercury; a specific conductance meter can be used to measure salinity. The accuracy of a DO meter at 0.0 mg/L is verified by measuring the DO of a fresh solution of sodium sulfite, prepared as described by Lewis (2005). The zero-DO measurement also serves to ensure the integrity of the electrolyte solution, the membrane, and the retaining ring. Calibration and operation procedures differ among instrument types and makes, and the manufacturer's instructions must be followed closely.

## pH

A detailed description of the 10-step calibration process for pH meters, including a wide range of available equipment, is provided by Radtke and others (2003). Calibration and adjustments for multiparameter sensor systems are available in manufacturers' servicing manuals. Accuracy of field pH meters should be at least  $\pm 0.1$  pH unit. Two standard buffer solutions bracketing the expected range of environmental values are used to calibrate a pH electrode, and a third is used as a check for calibration range and linearity of electrode response. The pH-7 buffer is used to establish the null point, and a pH-4 or pH-10 buffer is used to establish the slope of the calibration line at the temperature of the solution. The slope of a pH electrode is temperature sensitive, but the pH slope for modern sensors usually is adjusted to the observed temperatures through automatic temperature compensation by use of the theoretical Nernst equation (Radtke and others, 2003). It is important that the temperatures of the buffers be as close as possible to the samples being measured. Immersing the pH buffer bottles in the aquatic environment for about 15 minutes allows the buffer temperature to equilibrate to the aquatic environment. Standard buffers of pH 4, 7, and 10 are readily available from the NFSS. Proper calibration of pH sensors does not ensure accurate pH measurements for low specific conductance waters. Consult the USGS National Field Manual for the recommended procedure when the specific conductance of the water sample is less than 100  $\mu\text{S}/\text{cm}$  (Busenberg and Plummer, 1987; Radtke and others, 2003).

## Turbidity

Proper calibration and documentation for turbidity meters are described by Anderson (2004). The three types of turbidity

calibrants are (1) reference turbidity solutions, (2) calibration turbidity solutions, and (3) calibration verification solutions and solids. Reference turbidity solution is a calibrant that is synthesized reproducibly from traceable raw materials by a skilled analyst. The reference standard is fresh user-prepared formazin, prepared as described by Anderson (2004) or American Public Health Association (1998). All other calibrants are traced back to this reference solution. Calibration of a turbidity instrument by using reference turbidity solutions should be done only in the laboratory.

Meters are calibrated using calibration turbidity solutions, which must be traceable and equivalent to the reference turbidity calibrants. Acceptable calibration turbidity solutions include commercially prepared formazin, stabilized formazin (such as StablCal™), and styrene divinylbenzene (SDVB) polymer standards (such as Amco AEPA-1™ Polymer). Calibration turbidity solutions for various ranges are available commercially. Formazin-based calibrants can be diluted by using a dilution formula; however, errors may be introduced during the dilution process, thus reducing the accuracy of the standard solution. Formazin-based calibrants also are temperature dependent, and accurate readings may be difficult to obtain during field conditions. Anderson (2004) suggests that the effect of thermal fluctuations can be minimized by calibrating the instrument at room temperature in an office laboratory using a reference or calibration turbidity solution. Instrument calibration can then be checked at the field site by using a calibration verification calibrant.

Calibration verification calibrants may include, but are not limited to, calibration turbidity solutions; however, calibration verification calibrants that are sealed or solid materials must not be used to adjust instrument readings (Anderson, 2004). Before placing the sensor in a calibration verification calibrant, the sensor must be cleaned, rinsed three times with turbidity-free water, and carefully dried. Turbidity-free water is prepared as described by Anderson (2004).

## Monitor Operation and Maintenance

The operational goal for monitoring water quality is to obtain the most accurate and most complete record possible. The general operational categories include maintenance of the monitoring station and equipment, periodic verification of sensor calibration, troubleshooting of sensors and recording equipment, and thorough record keeping.

A standard protocol is common for the operation of continuous water-quality monitors in nearly all aquatic environments and site characteristics; only the cleaning and calibration steps (steps 3–5 in table 4) differ for determining error as a result of fouling and calibration drift. The standard protocol supports two methods for cleaning and calibration: (1) a method for monitors in well-mixed, stable, or slowly changing aquatic environments; and (2) a method for monitors in stratified or dynamic, rapidly changing conditions, such as those typically found in estuarine environments or in warm,



**Table 4.** Standard protocol for the operation and maintenance of a continuous water-quality monitor.

1.	Conduct site inspection
a.	Record monitor readings, time, and monitor conditions
b.	With an independent field meter, observe and record readings and time near the sensor(s)
2.	Remove sonde from the monitoring location
3.	Clean sensors
4.	Return sonde to the monitoring location
a.	Record monitor readings and time
b.	Using an independent field meter, observe and record readings near the sensor(s)
5.	Remove sonde, rinse thoroughly, and check calibration
a.	Record calibration-check values
b.	Recalibrate if necessary
6.	Return sonde to monitoring location
a.	Record monitor readings and time
b.	Using an independent field meter, observe and record readings near the sensor(s)

sluggish, biologically active environments. The second method is used when changes in the monitored field measurements are greater than the calibration criteria (see *Monitor Calibration Criteria*), when measured field parameters are rapidly changing, or when measurements are fluctuating (see *Rapidly Changing Conditions*). Rapid change is defined as change that exceeds the calibration criteria (see *Monitor Calibration Criteria*) within 5 minutes.

### Standard Protocol

The standard protocol is a series of procedures that must be performed routinely at all continuous water-quality stations (table 4) as fully described in this report. Site characteristics, such as stratification or dynamic, rapidly changing environmental conditions, may make it necessary to modify the standard protocol (see *Rapidly Changing Conditions*). Alternative methods that combine aspects of these techniques for cleaning and calibrating monitors also are possible. Environmental conditions or data-quality objectives may dictate the most appropriate method. For example, under conditions of rapidly rising streamflow or extreme low-flow conditions that lead to rapidly changing field parameters, measurements that are more accurate and perhaps safer working conditions may be obtained by using a modified protocol for rapidly changing environmental conditions. Experience and knowledge of site conditions will aid in the choice of cleaning and calibration methods.

### Maintenance

Maintenance frequency generally is governed by the fouling rate of the sensors, and this rate varies by sensor type, hydrologic and environmental conditions, and season. The performance of temperature and specific conductance sensors tends to be less affected by fouling than the DO, pH, and turbidity sensors. The use of wiper or shutter mechanisms on modern turbidity instruments has substantially decreased fouling in some aquatic environments. For sites with data-quality objectives that require a high degree of accuracy, maintenance can be weekly or more often (table 5). Monitoring sites with nutrient-enriched waters and moderate to high temperatures may require maintenance as frequently as every third day. In cases of severe environmental fouling or in remote locations, the use of an observer to provide more frequent maintenance to the water-quality monitor should be considered.

In addition to fouling problems, monitoring disruptions as a result of recording equipment malfunction, sedimentation, electrical disruption, debris, ice, pump failure, or vandalism also may require additional site visits. Satellite telemetry can be used to verify proper equipment operation on a daily basis and can aid the field hydrographer in recognizing and correcting problems quickly. Satellite telemetry is recommended for sites where lost record will critically affect project objectives.

Specific maintenance requirements depend on the site configuration and equipment. A useful discussion of the maintenance requirements for the flow-through and USGS minimonitor installations is available in Gordon and Katzenbach (1983), but nearly all operational requirements are fulfilled by the completion of the USGS water-quality continuous monitor field-inspection form (Attachment 1). Manufacturer’s instructions must be followed for other types of equipment or sensors.

**Table 5.** General maintenance functions at a water-quality monitoring station.

Daily maintenance functions (for sites equipped with telemetry)
Daily review of sensor function and data download Battery (or power) check Deletion of spurious data, if necessary
Maintenance functions during field visits
Calibration of the field meter(s) Inspection of the site for signs of physical disruption Inspection and cleaning of sensor(s) for fouling, corrosion, or damage Inspection and cleaning of deployment tube Battery (or power) check Time check Routine sensor cleaning and servicing Calibration check (and recalibration, if necessary) Downloading of data

## Sensor Inspection and Calibration Check

The purposes of sensor inspection are to verify that a sensor is working properly, to provide an ending point for the interval of water-quality record since the last maintenance visit, and to provide a beginning point for the next interval of water-quality record. This is accomplished by recording the initial sensor readings in the environment, cleaning the sensors, recording the cleaned-sensor readings in the environment, performing a calibration check of sensors by using appropriate calibration standards, and recalibrating the sensors if the readings are outside the ranges of acceptable differences (see *Monitor Calibration Criteria*). A final environmental sensor reading is required after the calibration check or after recalibration. The difference between the initial sensor reading and the cleaned-sensor reading is the sensor error caused by fouling; the difference between the cleaned-sensor readings in calibration standard solutions of known quality represents sensor error caused by calibration drift. If the calibrated sensor cannot be recalibrated or does not agree with the calibrated field meter, the faulty sensor must be repaired after verifying that the readings of the field meter are not in error (see *Troubleshooting Procedures*). The alternative is to replace the monitoring sonde or sensor with a calibrated backup unit and repair the malfunctioning monitor in the laboratory or return it to the manufacturer for repair. All information related to the sensor inspection must be recorded on a field form (Attachment 1), which then is the basis for data corrections made during the record-processing stage. Complete and thorough documentation of the sensor inspection is required.

### Steady-State Conditions

The standard protocol (table 4) is used for servicing sensors in stable or slowly changing (in one direction) environmental conditions. Slowly changing is defined as changes in field measurements during maintenance that are less than the calibration criteria (see *Monitor Calibration Criteria*). Readings to determine error caused by fouling and calibration drift are made while the monitor is deployed. The initial sensor readings (before cleaning) of the monitoring equipment are compared to readings from a calibrated field meter ideally located at the same measuring point in the aquatic environment. The sonde is then removed for servicing while the field meter remains in place. The initial sensor reading becomes the ending point of the data record since the

last servicing, and the field meter reading provides a sense of the reasonableness of the monitor readings and an indication of potential electronic calibration drift and fouling errors. Field meter readings should be recorded every 5 minutes, or more frequently if necessary.

Upon removal from the water, the monitoring sensors are inspected for signs of chemical precipitates, stains, siltation, or biological growths that may cause fouling. These observations are recorded in the field notes before cleaning, and then the individual sensors are cleaned according to the manufacturer's specifications. The cleaned sonde or sensor is then returned to the water, and the final (cleaned) sensor readings and field meter readings and times are recorded in the field notes after the sensor has equilibrated. If the conditions are steady state, the field meter readings should not change substantially during the time that the monitoring sensors are cleaned. The observed difference between the initial sensor reading and the cleaned-sensor reading is a result of fouling (chemical precipitates, stains, siltation, or biological growths). After all cleaned-sensor readings are recorded, the monitoring sensors are again removed from the water, calibration is checked in calibration standard solutions, and the readings are recorded (and recalibrated if necessary); the difference between the cleaned-sensor readings in calibration standard solutions and the expected reading in these solutions is the result of sensor-calibration drift error. The sonde is recalibrated if necessary and replaced in the aquatic environment, and a set of initial readings is taken as the start of the new record.

Except for temperature sensors, the field meter readings are not used directly in record computation; the field meter is used only as a tool to assess cross-section variability and environmental changes that may occur while the monitor is being serviced. If the environmental conditions are slowly changing while the monitor is being serviced and do not fluctuate, the fouling and calibration drift error can be computed with consideration being given to these environmental changes (see *Data-Processing Procedures*).

### Rapidly Changing Conditions

The standard protocol with minor modifications (table 6) is used when environmental conditions change rapidly or when measurements are fluctuating (increasing and decreasing; fig. 4). Rapid change is relative to the length of time needed to service the monitor and generally is defined as change that exceeds the calibration criteria within 5 minutes (see *Monitor*

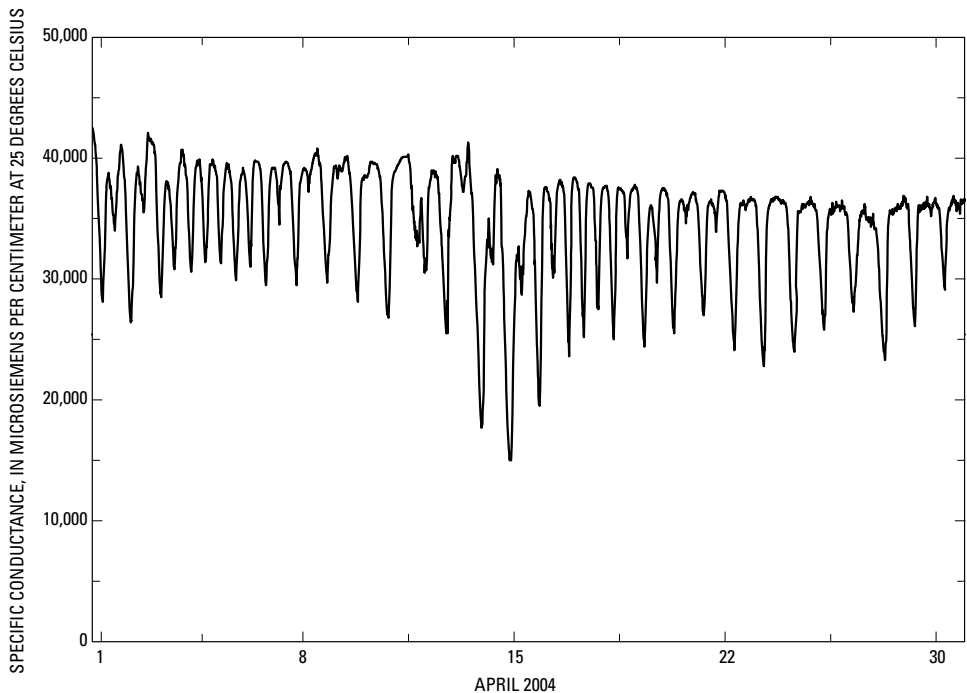


**Table 6.** Modified standard protocol for the operation and maintenance of a continuous water-quality monitor at a site with rapidly changing conditions.

1. Conduct site inspection
  - a. Record monitor readings, time, and monitor conditions
  - b. With an independent field meter, observe and record readings and time near the sensor(s)
2. Remove sonde from the monitoring location
3. Place the sonde and a field meter in an insulated 5-gallon bucket filled with ambient water
  - a. Record monitor readings, time, and monitor conditions
  - b. With an independent field meter, observe and record readings and time near the sensor(s)
4. Clean sensors
5. Return sonde to the insulated 5-gallon bucket
  - a. Record monitor readings and time
  - b. Using an independent field meter, observe and record readings and time near the sensor(s)
6. Remove sonde, rinse thoroughly, and check calibration
  - a. Record calibration-check values
  - b. Recalibrate if necessary
7. Return sonde to monitoring location
  - a. Record monitor readings and time
  - b. Using an independent field meter, observe and record readings near the sensor(s)

*Calibration Criteria*). Rapidly changing conditions typically occur in lakes and estuaries; a steep salinity or DO vertical gradient can result in large changes in salinity or DO over very short vertical distances. Internal water movement may further destabilize the gradient, and boat movement in choppy waters can make it impossible to replace the monitor or hold the field meter in one location. This effectively prevents comparison of pre-cleaned and cleaned-sensor readings to determine fouling per the standard protocol under steady-state conditions. Hazardous working conditions, especially in estuaries or large lakes, may limit the time that can be spent at the site and may require removal of the sonde and replacement after servicing. These situations require the use of a modified standard protocol for rapidly changing conditions (table 6). Such conditions also can occur in small streams or rivers, when rapidly increasing streamflow or extremely low streamflow conditions lead to rapidly changing field parameters that prevent comparison of pre-cleaned and cleaned-sensor readings in the stream. Experience and knowledge of site conditions will aid in the choice of servicing methods.

The modified standard protocol for rapidly changing conditions (table 6) generally follows the standard protocol (table 4) except that all measurements are made in ambient water collected in an ice cooler or insulated 5-gallon bucket that provides a stable environment for readings. First, sonde readings and time are recorded; the sonde is carefully removed from the water with minimal disturbance to any biological growth or sedimentation, inspected for signs of chemical precipitates, stains, siltation, or biological growths that may cause fouling, and placed in the bucket. The observations of fouling are recorded in the field notes. A calibrated field meter is



**Figure 4.** Example of rapidly changing recorded values of specific conductance at U.S. Geological Survey streamgaging station 02300554, Little Manatee River at Shell Point near Ruskin, Florida.

placed in the bucket next to the sonde, and pre-cleaned sensor readings and times are recorded. Field meter readings should be recorded every 5 minutes, or more frequently if necessary. The sonde is removed from the bucket and cleaned according to the manufacturer's specifications. The cleaned sonde is then returned to the bucket. After the sensors have equilibrated, the cleaned-sensor readings, field meter readings, and times are recorded in the field notes. The observed difference between the pre-cleaned sensor reading and the cleaned-sensor reading is a result of fouling. After all cleaned-sensor readings are recorded, the sensor calibration is checked in calibration standards, and the readings are recorded. The difference between the cleaned-sensor readings in calibration standard solutions and the expected reading in those solutions is caused by sensor calibration drift error. The sonde is recalibrated if necessary and replaced in the aquatic environment, and a set of initial readings is taken to represent the start of the new record. If turbidity is being measured, it may be more appropriate to use tap or distilled water rather than ambient water in the insulated bucket because of the possibility of turbid particles settling out in still water.

Because of the inherently variable nature of turbidity, measurements of turbidity in the stream before and after cleaning the sensor may not provide an accurate measure of fouling. A more accurate determination of fouling of turbidity sensors can be made by making pre-cleaning measurements in a bucket of clean tap or distilled water. Fouling is then determined by comparing measurements of turbidity in the bucket after cleaning the sensor, taking into consideration any changes in turbidity in the bucket, with measurements by a field meter.

### Alternative Methods for Servicing a Monitor

Other modifications to the standard protocol may be desirable based on data-quality objectives, site characteristics, and field conditions. The optimal method for determining fouling is to record pre-cleaned and cleaned-sensor readings at the field site in a stable environment. In hazardous field situations, such as working from a boat in choppy waters, it may be difficult to perform accurate calibration checks. It may be more practical to exchange the sonde with a clean, calibrated sonde. One example of an alternative method for servicing a monitor is water-quality sonde exchange, in which fouling is

determined by pre-cleaned and cleaned-sensor readings at the site but calibration checks are made off site, and the sonde is replaced with another clean, calibrated sonde. Once the sonde is cleaned, calibration checks can be performed elsewhere if care is taken in transporting the sonde; however, calibration of replacement sondes should be performed at or near the field site, especially if DO is being measured. If conditions prevent field calibration, the replacement sonde should be calibrated in the office or laboratory, and a minimal one-point calibration check must be performed on site or in a nearby mobile laboratory.

Data-quality objectives may require even further modifications of the standard protocol. In this case, the sonde is carefully removed from the monitoring location, and pre-cleaned and cleaned-sensor readings are made off site in a less hazardous environment to determine fouling, and calibration checks are made for calibration drift. All modifications to the steady-state protocol introduce the possibility of immeasurable errors into the process and may preclude identifying calibration drift error and fouling error separately. Consideration of these errors should be taken into account when rating the accuracy of the record (see *Final Data Evaluation*).

### Monitor Calibration Criteria

When calibration checks reveal only a small amount of calibration drift, it may not be necessary to recalibrate the instrument (Gordon and Katzenbach, 1983). Under field conditions, the operating accuracy of the equipment has limits. Within these acceptable limits (calibration criteria), adjustments to calibration may not improve overall data accuracy. The calibration criteria for water-quality monitors (table 7) are based on stabilization criteria defined by Wilde and Radtke (2005). The criteria take into consideration the lower accuracy of some continuous water-quality sensors. In practice, a calibration check of cleaned sensors using calibration

**Table 7.** Calibration criteria for continuous water-quality monitors.

[±, plus or minus value shown; °C, degree Celsius; μS/cm, microsiemens per centimeter at 25 °C; %, percent; mg/L, milligram per liter; pH unit, standard pH unit; turbidity unit is dependent on the type of meter used]

Measurement	Calibration criteria (variation outside the value shown requires recalibration)
Temperature	±0.2 °C
Specific conductance	±5 μS/cm or ±3% of the measured value, whichever is greater
Dissolved oxygen	±0.3 mg/L
pH	±0.2 pH unit
Turbidity	±0.5 turbidity unit or ±5% of the measured value, whichever is greater

standards is compared to the calibration criteria. If calibration drift is within the calibration criterion, the sensor is considered stable and recalibration is not required.

## Field Cleaning of Sensors

During the cleaning process, care should be taken to ensure that the electrical connectors are kept clean and dry. Water in the connector pins can cause erratic readings. For this reason, a container of compressed air is a useful component of field-cleaning supplies. Most commercially available temperature sensors can be cleaned with a detergent solution and a soft-bristle brush. Film on the sensor that resists removal usually can be removed by soaking the sensor in a detergent and water solution (Ficken and Scott, 1989), but the manufacturer's recommended cleaning procedures must be followed carefully for multiparameter sensor systems.

Radtke and others (2005) recommend cleaning specific conductance sensors thoroughly with de-ionized water before and after making a measurement. Oily residue or other chemical residues (salts) can be removed by using a detergent solution. Specific conductance sensors can soak in detergent solution for many hours without damage. Oil or other residues can be removed by dipping the sensor in a solvent or diluted hydrochloric acid solution (5 percent), but the manufacturer's recommendations must be checked before using acid solution or solvents on sensors. The sensor must never be in contact with acid solution for more than a few minutes. Carbon and stainless-steel sensors can be cleaned with a soft brush, but platinum-coated sensors must never be cleaned with a brush.

Routine cleaning of DO sensors involves using a soft-bristle brush to remove silt from the outside of the sensor, wiping the membrane with a damp, lint-free cotton swab (available at local electronics stores), and rinsing with de-ionized water. The sensor usually is covered with a permeable membrane and filled with a potassium chloride solution. The membrane is fouled easily and typically will need to be replaced every 2 to 4 weeks. When the membrane is replaced, the potassium chloride solution must be rinsed out of the sensor with de-ionized water followed by several rinses with potassium chloride solution before the sensor is refilled. The membrane must be replaced with care so that the surface of the membrane is not damaged or contaminated with grease, and no bubbles are trapped beneath the membrane. The surface of the membrane should be smooth, and the membrane should be secured tightly with the retaining ring. The sensor must be stored in water for a minimum of 2 to 4 hours, preferably longer, to relax the membrane before installation and calibration. The time required to relax the membrane requires either replacing the DO sensor membrane with a pre-relaxed membrane and recalibrating or replacing the membrane and revisiting the site for calibration later. The retaining ring must be replaced annually or more frequently to prevent loss of electrolytes. Replacing the retaining ring when membranes are changed ensures a tight seal.

The gold cathode of the DO sensor also can be fouled with silver over an extended period of time, and a special abrasive tool usually is required to recondition the sensor. A fouled anode, usually indicated by the white silver electrode turning gray or black, can prevent successful calibration. As with the cathode, the sensor anode usually can be reconditioned following the manufacturer's instructions. Following reconditioning, the sensor cup must be rinsed, refilled with fresh potassium chloride solution, and a new membrane installed.

The pH electrode must be kept clean, and the liquid junction (if applicable) must be free flowing in order to produce accurate pH values (Radtke and others, 2003). The body of the electrode should be thoroughly rinsed with de-ionized water before and after use. In general, this is the only routine cleaning needed for pH electrodes; however, in cases of extreme fouling or contamination, the manufacturer's cleaning instructions must be followed.

Turbidity sensors are extremely susceptible to fouling; thus, frequent maintenance trips may be necessary to prevent fouling of the turbidity sensor in an aquatic environment high in sediment, algae accumulation, larvae growth, or other biological or chemical debris. Mechanical cleaning devices, such as wipers or shutters that remove or prevent accumulation, are available for modern sensors. In environments that cause severe algal fouling, however, algae can accumulate on the wiper pad preventing complete removal of algal fouling from the optical lens and resulting in erratic turbidity data. Similarly, inorganic or organic debris can lodge in shutters, allowing fouling to accumulate and preventing efficient operation of the sensor. If the turbidity sensor is not equipped with a mechanical cleaning device that removes solids accumulation or a shutter that prevents accumulation on the lens before readings are recorded, reliable data collection is very difficult.

Sensors first should be inspected for damage, ensuring that the optical surfaces of the probe are in good condition. The wiper pad or other cleaning device also should be inspected for wear and cleaned or replaced if necessary. Before placing the turbidity sensor in standards, the optic lens should be carefully cleaned with alcohol by using a soft cloth to prevent scratching (or as recommended by the manufacturer), rinsed three times with turbidity-free water, and carefully dried. If the readings are unusually high or erratic during the sensor inspection, entrained air bubbles may be present on the optic lens and must be removed.

## Field Calibration of Sensors

A water-quality monitoring sensor or sonde should be calibrated in the laboratory before installation at a field location and checked for calibration at the field site. Calibration in the laboratory or the field is done only by using calibration standards of known quality. During field visits, calibration of all sensors should be checked with two standard solutions that bracket the range of expected environmental conditions and a third standard near the ambient environmental conditions before any adjustments are made to the monitor calibration.

Field calibration is performed if the cleaned-sensor readings obtained during the calibration check differ by more than the calibration criteria (table 7). Spare monitoring sondes or sensors are used to replace water-quality monitors that fail calibration after troubleshooting steps have been applied (see *Troubleshooting Procedures*). All calibration equipment and supplies must be kept clean, stored in protective cases during transportation, and protected from extreme temperatures.

### Temperature Sensors

Modern temperature sensors are quite sturdy and accurate, and the manufacturers generally make no provisions for field calibration of the temperature sensor. Temperature readings are compared between the sensors and thermometers that have been certified by the local USGS Water Science Center with an NIST-traceable thermometer as described by Radtke and others (2004). Temperature accuracy is especially important because of the effect of temperature on the performance of other sensors. Before a field trip, the Water Science Center certification labels on thermometers or thermistors should be checked to ensure that the certification is current and that the thermometer or thermistor is appropriate for use in extreme field conditions.

The temperature sensor and the calibrated field thermistor are placed adjacent to each other, preferably in flowing water or an insulated bucket of water. If a liquid-in-glass thermometer is used, it must be the total-immersion type. Sufficient time for temperature equilibration must elapse before a reading is made. The two temperature sensors must be read and the temperatures recorded instantaneously. If the monitoring temperature sensor fails to agree within  $\pm 0.2$  °C, troubleshooting steps must be taken; if troubleshooting fails, the sensor must be replaced. The faulty sensor or sonde should be returned to the manufacturer for proper calibration, repair, or replacement.

### Specific Conductance Sensors

Calibration of specific conductance sensors should be checked with three calibration standard solutions of known quality before any adjustments are made, thus providing data for possible three-point calibration drift corrections (see *Application of Data Corrections*). Calibration checks must be made with two standard solutions that bracket the expected range of environmental conditions and a third standard solution near the ambient specific conductance value of the water. In addition, the zero response of the dry sensor in air should be checked and recorded to ensure linearity of sensor response at low values. If sensor-cleaning processes fail to bring a specific conductance sensor within the calibration criteria (table 7), the sensor must be recalibrated. Field calibration differs among the types of instruments, but most sensors generally are calibrated with only one or two standards. The manufacturer's calibration procedures should be followed.

Expiration dates and lot numbers for the standard solutions must be recorded and the standard solution bottles

allowed to equilibrate to the temperature of the aquatic environment (by immersing in the water for 15 to 30 minutes). After three calibration standard solutions are checked and recorded (without making any adjustments), the monitor is recalibrated, if necessary, by using the appropriate calibration standard solutions and following the manufacturer's calibration procedures. The sensor, thermistor or thermometer, and measuring container must be rinsed three times with a standard solution. Gentle tapping will ensure that no air bubbles are trapped on the sensor. Fresh standard solution is poured into the calibration cup; the temperature setting is adjusted, if necessary; the specific conductance values, calibration standard values, and temperature are read and recorded in the field notes and the monitoring instrument log. A temperature correction may be necessary if the monitor does not have automatic temperature correction (Radtke and others, 2005).

Standard solution that has been used is discarded into a waste container, and the procedure is repeated using a second or third standard solution to check linearity of sensor response. If the sensor readings differ from the standards by more than 5  $\mu\text{S}/\text{cm}$  or 3 percent, whichever is greater, the calibration sequence must be repeated. If the second calibration sequence still differs by more than the calibration criteria, troubleshooting techniques must be attempted (see *Troubleshooting Procedures*). If these steps fail, the sonde or monitoring sensor must be replaced and the backup instrument calibrated.

### Dissolved Oxygen Sensors

Dissolved oxygen in water is related to temperature, atmospheric pressure, and salinity. Calibration of DO sensors should be checked at 100-percent saturation and with a fresh zero-DO solution before any adjustments are made. Lewis (2005) provides detailed steps for four different calibration procedures: (1) air-calibration chamber in water, (2) air-saturated water, (3) air-calibration chamber in air, and (4) iodometric (Winkler) titration. The first three procedures calibrate DO to 100-percent saturation by an amperometric method. Based on measured temperature and atmospheric pressure, the saturated DO is obtained from a reference table developed by Weiss (1970) as described in U.S. Geological Survey (1998) and reproduced by Lewis (2005). An interactive program also is available for producing a table of DO saturation values (<http://water.usgs.gov/software/dotables.html>) to the nearest 0.1 or 0.01 mg/L over user-defined ranges of temperature and barometric pressure and a table of salinity-correction factors over user-defined ranges of specific conductance. Ambient atmospheric pressure must be determined with a calibrated pocket barometer to the nearest 1 mm of mercury. The fourth method, the iodometric titration method, measures DO in an unknown sample directly (by a dye color change upon reduction of available oxygen) to determine the sample concentration to which the DO sensor is calibrated. The appropriate procedure depends on the type of monitoring equipment. The manufacturer's calibration procedures must be



followed closely to achieve a calibrated accuracy of  $\pm 0.3$  mg/L concentration of DO. Calibration of field barometers should be checked before each field trip, preferably by checking with an official weather station (Lewis, 2005).

Most DO sensors can be calibrated only with a one-point calibration, usually at 100-percent saturation, although some sondes have the capability of a two-point calibration, at zero-percent and 100-percent saturation. For the sondes that are calibrated only at 100-percent saturation, the DO sensor response is checked in a zero-DO sodium-sulfite solution. A fresh zero-DO standard solution should be prepared before each field trip, as described by Lewis (2005).

Calibration in the field presents a problem because replacement of the Teflon® membrane may be required frequently, and the replaced membrane must be allowed to “relax” in water for 2–4 hours before calibration (Lewis, 2005). One solution to this problem is to carry into the field clean and serviced spare DO sensors, stored in water (or moist, saturated air). The replacement DO sensors then can be calibrated in the field, thus avoiding an interruption in the record and a return site visit.

Luminescent-based DO sensors are calibrated by the manufacturer, and the manuals indicate that calibration may not be required for up to a year. When calibrated, the user should follow the manufacturer’s guidance. Regardless of the manufacturer’s claims, the user must verify the correct operation of the sensor in the local measurement environment. The standard protocol for servicing should be used for luminescent-based DO sensors to quantify the effects of fouling and calibration drift. Lewis (2005) advises users to make frequent calibration checks and to recalibrate as frequently as required to meet the specific data-quality objectives. Recalibration should not be necessary if calibration checks show the sensor to be in agreement with the calibration criteria (table 7).

**pH Sensors**

Field calibration of pH sensors often is a time-consuming process that requires patience. Expiration dates for the pH-4, 7, and 10 buffer solutions must be checked, and spare pH sensors or backup sondes will need to be prepared in case replacement of the sensors is required.

Upon arrival at the field site, tightly capped buffer solutions are immersed in the aquatic environment to allow time for temperature equilibration, usually 15 to 30 minutes. Prior to replacement or calibration of the pH sensor, the cleaned sensor should be checked for calibration drift in all three buffer solutions. If the pH sensor readings exceed the calibration criteria (table 7), the monitoring sensor must be calibrated as described by the manufacturer’s instructions.

Temperature effects on pH buffer solutions vary with individual solutions, and the temperature-correction factor must be verified with the manufacturer. Examples of common pH buffer solution variances with temperature are given in table 8. The pH sensor reading must be standardized to the temperature-corrected pH value.

**Table 8.** Example of the effects of temperature on pH calibration standard solutions.

[°C, degree Celsius; all pH values are in standard pH units. Temperature-compensation values for pH may vary with buffer manufacturers; refer to manufacturer’s specifications for actual buffer values]

Temperature (°C)	pH buffer solution nominal value		
	4.01	7.00	10.00
0	4.00	7.14	10.30
5	4.00	7.10	10.23
10	4.00	7.07	10.17
15	4.00	7.04	10.11
20	4.00	7.02	10.05
25	4.01	7.00	10.00
30	4.01	6.99	9.96
35	4.02	6.98	9.92
40	4.03	6.98	9.88

For most sondes, a two-point calibration is used. A relative zero is established with a pH-7 buffer and the slope is set with a pH-4 or pH-10 buffer. A three-point calibration may be used for some sondes. To begin calibration, the pH sensor, thermistor or thermometer, and calibration cup are rinsed with pH-7 buffer solution, which is then discarded along with all subsequent rinsates in a waste container. Fresh pH-7 buffer solution is poured into the rinsed calibration cup, and the instruments are allowed to equilibrate for at least 1 minute before the buffer solution is discarded and fresh pH-7 buffer solution is poured into the calibration cup. The solution is slowly swirled in the calibration cup, ensuring that the pH sensor and thermistor are fully immersed and that values have stabilized. The temperature, pH, and associated millivolt reading (if available) are measured and recorded, along with lot numbers and expiration dates of the pH buffers. This standardization process is repeated with fresh pH-7 buffer solution until two successive values of the temperature-adjusted pH-7 readings are obtained.

The pH sensor, thermistor or thermometer, and calibration cup are rinsed with de-ionized water, and the standardization process is repeated with a pH-4 or pH-10 buffer solution to establish the response slope of the pH sensor. A buffer that brackets the expected range of pH values in the environment should be selected. The second temperature-corrected pH value, temperature, millivolt readings, lot numbers, and expiration dates are recorded, and the pH sensor, thermistor or thermometer, and calibration cup are rinsed with de-ionized water. The pH-7 buffer solution is then used to rinse, fill, and check the pH-7 calibration measurement. If the pH sensor reading is  $7 \pm 0.1$  pH units, the slope adjustment has not affected the calibration. If the accuracy standard is not met, the calibration and slope adjustment steps must be repeated. If repeated calibration and troubleshooting steps fail, the pH sensor or monitoring sonde must be replaced.

Once the slope-adjustment step is completed satisfactorily, the third buffer solution can be used as a check for calibration range and linearity of electrode response. The temperature and pH values are read and recorded along with the lot numbers and expiration dates of the pH buffers; however, the  $\pm 0.1$  pH accuracy should not be expected to be achieved over the full range from pH-4 to pH-10 for a monitoring sensor. The third buffer should be within  $\pm 0.2$  pH unit value.

Waters with specific conductance values less than  $100 \mu\text{S}/\text{cm}$  may require special low-ionic strength buffers and pH sensors. The extra preparations, precautions, and troubleshooting steps necessary for using these buffers and sensors to measure low-ionic strength waters are described in Busenberg and Plummer (1987).

### Turbidity Sensors

Field inspection or calibration of the turbidity sensor is made by using approved calibration turbidity and calibration verification solutions and by following the manufacturer's calibration instructions as described in Anderson (2004). Turbidity standard solutions with various ranges are available commercially, and most sensor manufacturers recommend either formazin-based or SDVB-polymer standards for calibrating turbidity sensors. Formazin-based standard solutions can be diluted by using a dilution formula; however, errors may be introduced during the dilution process, thus reducing the accuracy of the standard solution. Turbidity-free water, used in the preparation of standard solutions, dilution, and rinsing, should be prepared as described in Anderson (2004). Checking or calibrating the turbidity sensor must occur in an environment in which stable readings can be obtained. Such an environment minimizes movement of the standard solutions, wind, or direct sunlight as much as possible. Care should be taken to avoid interference from the bottom of the calibration vessel. Follow the manufacturer's recommendations for calibration.

Calibration of the turbidity sensor should be checked in three standard solutions before any adjustments are made. If the sensor readings exceed the calibration criteria (the greater of  $\pm 5$  percent or 0.5 turbidity unit) during the inspection process, the sensor must be calibrated. A three-point calibration process is recommended, covering the expected range of values, although some instruments may be limited to calibration with only one or two standards. If instrument calibration

allows only a two-step process, two primary standard solutions covering the expected range must be used for calibration and a third midpoint standard solution is used to check for linearity. Similarly, if the instrument calibration requires only turbidity-free water and one standard solution, another midpoint standard solution must be used to check for linearity.

Large particles, leaves, twigs, or other natural debris may interfere with the measurement of true turbidity by causing spikes in the data. Most turbidity sondes designed for continuous deployment have a filtering algorithm coded in the instrument software that eliminates such spikes. The data-processing algorithms may be programmed in the sensor software with no options for user input. User-defined variables, such as time constants and spike thresholds, may be permitted using proprietary algorithms. Anderson (2004) describes some instruments that have the capability of providing such statistics as maximum, minimum, mean, median, range, and variance of multiple readings over a time span of a few seconds. These statistics can be useful for reducing variability in recorded turbidity readings, for understanding sources of turbidity, or for diagnostic purposes. Anderson (2004) cautions that algorithms that are intended to reduce spikes in instantaneous data can provide a smoother signal than simple instantaneous measurements; however, because the algorithms may not be published, these data must be used with care and in consideration of the data-quality objectives of the study. Because signal averaging to smooth the data output alters the instrument response to changes in turbidity readings, true changes in turbidity may not be measured.

### Troubleshooting Procedures

When a field parameter cannot be calibrated with standard solutions, the hydrographer must determine if the problem is with the sensor or the monitor and make the necessary corrections to ensure that the monitor is operational. The hydrographer should carry spare sensors and sondes so that troubleshooting can be accomplished at the time of the service visit. Troubleshooting in the field can prevent the need for extra trips and greatly reduce record loss and the amount of time spent in processing records in the office. A successful service trip results in a properly calibrated and fully functional monitor. Some of the more common problems that are encountered in the field when servicing monitors are listed in table 9.

**Table 9.** Troubleshooting problems with water-quality monitors.

[DO, dissolved oxygen; %, percent]

Symptom	Possible problem	Likely solution
<b>Water temperature</b>		
Thermistor does not read accurately	Dirty sensor	Clean sensor.
Erratic monitor readings	Poor connections at monitor or sensor	Tighten connections.
Monitor slow to stabilize	Dirty sensor	Clean sensor.
Readings off scale	Failure in electronics	Replace sensor or monitor.
<b>Specific electrical conductance</b>		
Will not calibrate	Standard solutions may be old or contaminated	Use fresh standard solutions.
	Electrodes dirty	Clean with soap solution.
	Air trapped around sensor	Thrust sensors up and down and tap gently to expel air.
	Weak batteries	Replace batteries.
Erratic monitor readings	Loose or defective connections	Tighten or replace connections.
Monitor requires frequent calibration	Broken cables	Replace cables. Replace monitor.
<b>Dissolved oxygen</b>		
Meter drift or excessive time for monitor to stabilize	Temperature compensator has not equilibrated with temperature of stream	Wait for temperature equilibration.
	Fouled sensor	Clean or recondition.
	Stirrer or pulse mechanism not working properly	Check for obstructions or replace.
Erratic monitor readings	Bad connection at monitor or sensor Fouled sensor	Tighten connections. Clean or recondition.
Monitor slow to stabilize	Gold cathode tarnished Fouled membrane Silver anode blackened	Buff with ink eraser or recondition sensor. Recondition sensor and replace membrane. Replace sensor and soak fouled sensor in 3-percent ammonia for 24 hours.
Monitor will not zero	Zero-DO solution contains oxygen Zero-DO solution is old	Add additional sodium sulfite to zero-DO solution. Mix a fresh solution.
Monitor will not calibrate	Membrane damaged Electrolyte diluted	Replace membrane. Replace membrane and electrolyte.
<b>pH</b>		
Meter will not calibrate	Buffers may be contaminated	Replace buffers.
	Faulty sensor	Replace sensor.
Slow response time	Dirty sensor bulb Water is cold or of low ionic strength	Clean sensor. Be patient.
Erratic readings	Loose or defective connections Defective sensor	Tighten connections. Replace sensor.
<b>Turbidity</b>		
Unusually high or erratic readings	Entrained air bubbles on the optical sensor	Follow manufacturer's directions.
	Damaged sensor	Replace sensor.
	Dirty sensor	Clean, following manufacturer's directions.
	Water in connections	Dry connector and reinstall.

## Requirements for Field Notes and Instrument Logs

Field notes and instrument logs are the basis for the accurate and verifiable computation of water-quality monitoring records. Legible, detailed, and in-depth field notes and instrument logs are essential for accurate and efficient record processing. Minimum field-note requirements for water-quality monitors include the following items:

- Station number and name
- Name(s) of data collector(s)
- Date, time, and time datum of each set of measurements
- Serial or “W” numbers of field meters and monitor
- Lot numbers and expiration dates of calibration standard solutions
- Purpose of the site visit
- Horizontal and vertical locations of sensors in the cross section
- Recorded monitor values, field values, and corresponding time and time datum (pre-cleaned, cleaned, calibration checks, calibrations, and final in-stream readings)
- Cross-section survey data and(or) vertical-profile data (locations of vertical points, measured field parameter values, and measurement times), and monitor values before and after the cross-section survey
- Pertinent gage-height data
- Remarks that describe channel and site conditions, condition of the sensors, and any other pertinent observations
- Battery voltage of monitor at arrival and departure (was battery replaced?)
- Notes on sensor changes or replacements, troubleshooting performed, and other remarks or observations that may aid in further processing of the record

The use of field-note forms that include these items encourages consistency and helps to avoid the costly omission of critical information. The USGS standard field form for continuous water-quality monitors contains a comprehensive checklist for data collection at many water-quality monitoring sites (Attachment 1). The current version of the USGS standard field form can be accessed by USGS personnel at <http://water.usgs.gov/usgs/owq/Forms.html>. Modifications of this form or alternative forms must be approved by the USGS Water Science Center water-quality specialist or designated reviewer.

An instrument logbook must be maintained for each field meter and water-quality monitor, and all pertinent information regarding the monitor and field meter must be recorded in the appropriate logbook. Details of instrument calibration—both field and laboratory calibrations—are one of the most important pieces of recorded information. Calibration information can be recorded initially on field forms or in field notebooks, but the information then must be copied into the instrument logbook. Repair or replacement of sondes, sensors, membranes, or modification to the sonde software must be recorded in the instrument logbook. The instrument logbook must contain a complete record of all maintenance in the field, the laboratory, or by the manufacturer. Permanent instrument logs contain critical calibration and maintenance information that documents instrument performance throughout the service life of the instrument. Calibration information that is important to log for record processing includes

- Sensor repair or replacement;
- Calibration dates, times, time datum, and temperatures;
- Calibration standard values, expiration dates, and lot numbers;
- Initial and final monitor-calibration data; and
- Field meter calibration values.

Field notes and calibration information should be clearly written, and all notations must be self explanatory. The goal is to have sufficient information for another individual to be able to independently compute the record with similar results. Clear notes simplify the record computation and final review processes.

## Record Computation

The record-computation process verifies the data and documents its quality. Accurate field notes and calibration logs are essential in processing the record. The hydrographer who services the water-quality monitor typically computes the water-quality data record, writes the manuscript that describes the data, updates the station description and station analysis, and prepares the data-record review package.

The primary steps in processing the record are an initial data evaluation, removal of erroneous data, application of data corrections, and a final data evaluation. The initial data evaluation should begin immediately upon completion of the field trip to ensure that all necessary information is available and to check for possible instrument malfunctions that may not have been observed in the field. Immediate corrections to obviously erroneous data are required for data that are transmitted to the Internet. Application of data corrections and record computation are essential within a few weeks of servicing a monitor, or more frequently if the data are being



served to the public over the Internet. Record computation and final review of the record ensure that the data are accurate and ready for publication.

## Data-Processing Procedures

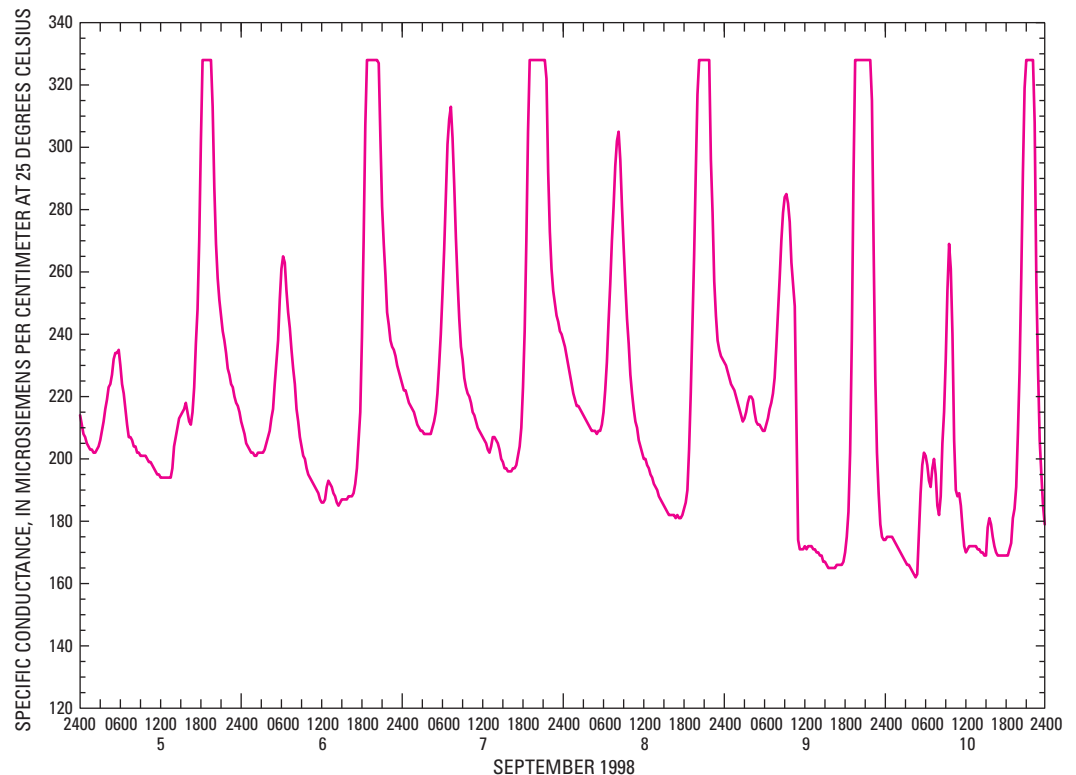
The processing of water-quality monitoring records must be completed in a timely manner according to Water Science Center or project quality-assurance plan policies. Complete and accurate field notes reduce the amount of time required to process the data and are an essential part of the process. Corrections to data must not be made unless the cause(s) of error(s) can be validated or explained in the field notes or by comparison with information from adjacent stations (G.F. Ritz, Kenneth Butcher, Janine Ferarese, David Grey, John Kuzmiak, and William Payne, U.S. Geological Survey, written commun., 1998). Data processing includes six procedures: (1) initial data evaluation, (2) application of data corrections, (3) application and evaluation of cross-section corrections, (4) final data evaluation, (5) record computation, and (6) final record review. The first four procedures are discussed in this section, and the last two procedures are combined and discussed in a later section (see *Preparation of the Review Package*).

## Initial Data Evaluation

The initial data evaluation is conducted to verify the accurate transfer of raw field data (instrument readings) to the database and to evaluate and identify erroneous data. A variety of formats is available to store raw field data, depending on the recording equipment and the means of downloading data from the recording equipment. Many monitoring sites have transmitters that provide daily satellite downloads of data from the field; other monitoring sites have data loggers that record data for retrieval during site visits. Conversion of raw data into a standard format for NWIS storage is accomplished by use of the on-line computer program Device Conversion and Delivery System (DECODS). After data are stored in

NWIS, primary data tables and plots are produced for review using the Automated Data Processing System (ADAPS). See Attachment 2 for an example of an ADAPS primary data table.

Sensors, recorders, transmitters, receivers, relays, transmission systems, or unforeseen events can all produce erroneous data. Therefore, data that are automatically downloaded, decoded, and reported on the Internet should be reviewed daily to remove obvious erroneous data. Regardless of how data are recorded and downloaded, the record should be processed and plotted immediately after the service visit to confirm the accurate transfer of data and to detect instrument or sensor error. Missing data (for example, because of instrument or transmission problems) should be documented but not estimated (refer to "Use of the program HYDRA to estimate or modify unit values in ADAPS," USGS Office of Water Quality Technical Memorandum 2005.03, dated August 8, 2005, at <http://water.usgs.gov/admin/memo/QW/qw05.03.html>). Statistics for periods containing missing data should be calculated with care (see *Publication Criteria*). Figure 5 shows an example of a truncated continuous specific conductance record caused by exceedance of the data-logger maximum default setting of 330  $\mu\text{S}/\text{cm}$ . This condition was not noticed during routine site visits; and because the record was not computed, plotted, and reviewed following service visits, the truncated maximum values were not observed until the end of the water year. The maximum extremes for the affected record



**Figure 5.** Specific conductance record at Duwamish River at Tukwila, Washington, September 5–10, 1998, was truncated at 330 microsiemens per centimeter, which was the default maximum setting for the data logger.

were lost, and only minimum daily values could be published. A statement was added to the manuscript station description explaining that maximum values may have been exceeded during periods of missing record (see *Data-Qualification Statements* for details).

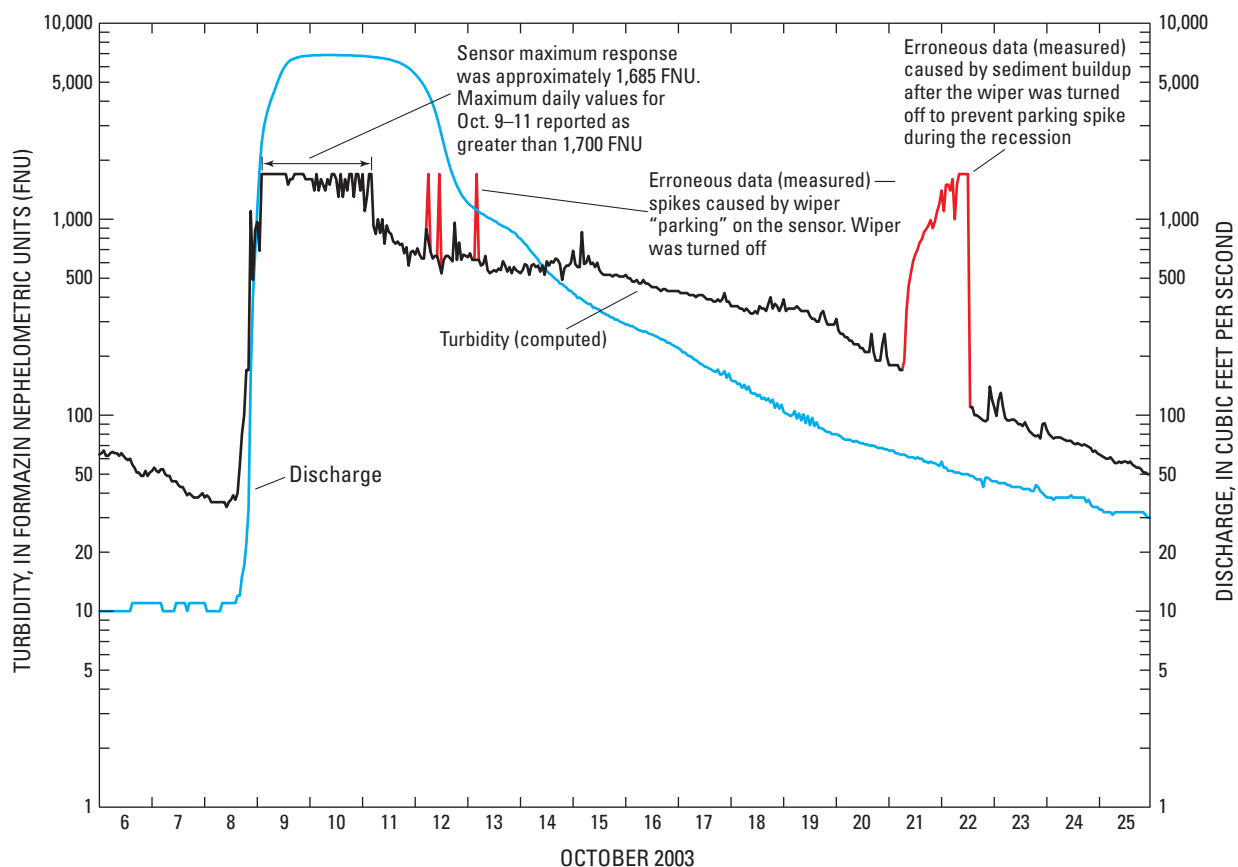
Turbidity sensors have a maximum reporting level that is limited by the type of optical sensor and the signal-processing electronics. During periods of runoff when high quantities of sediment are present and the clarity of the stream has been greatly reduced, turbidity increases substantially. It is not uncommon for the turbidity sensor to record values at its maximum reporting limit. When a turbidity sensor has reached its maximum signal output, the same maximum data value is recorded repeatedly over time (fig. 6). This period can be for a few hours or days depending on the stream runoff. Additionally, not all sensors have the same maximum reporting level. Maximum turbidity readings commonly range from 1,000 to 2,000 NTUs, even with sensors made by the same manufacturer. It should be noted, however, that turbidity readings that are truncated at a high value may indicate that the wiper has parked incorrectly on the optical sensor or the sensor may be buried in sediment (fig. 7). The maximum sensor response may differ from the reported maximum limit (see *Data Reporting* section).

Great emphasis has been placed on the relation of variations in the five water-quality properties (temperature, specific conductance, DO, pH, and turbidity) and discharge variations, but other event-related changes are equally important and can be factored into the relation only through historical measurements, field experience, and first-hand on-site observation. Some examples include changes in air temperature, periods of sustained cloud cover, chemical spills, increased photosynthesis (influenced by a variety of factors), increased wind conditions, combined sewer overflows, forest fires in the watershed, road construction, and ice formation.

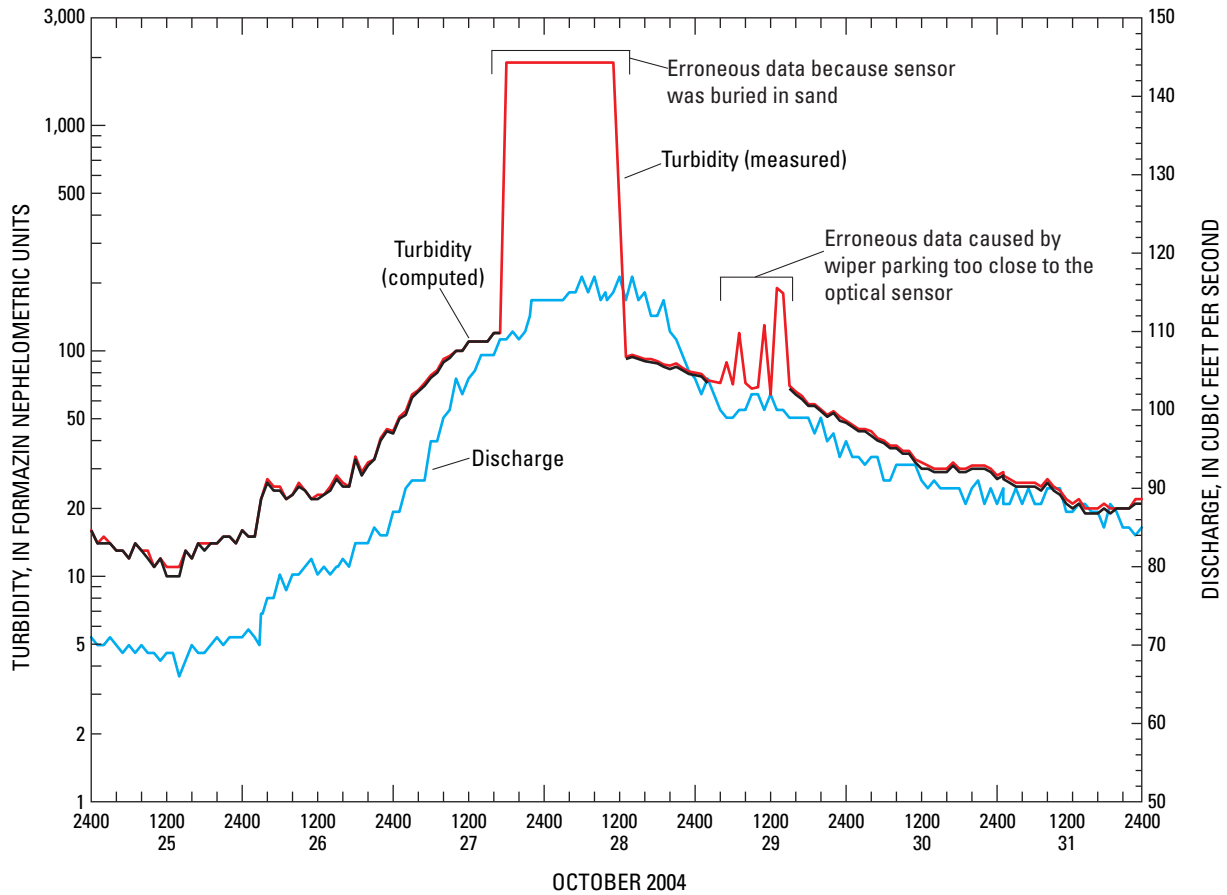
As mentioned previously, temperature, specific conductance, DO, pH, and turbidity have complex interdependencies. Understanding these relations is a necessary component of accurate water-quality record computation. Periodically visiting the upstream areas of the drainage basin and recording evidence of changes in land-use activities can help explain observed changes in water quality.

### Application of Data Corrections

The application of data corrections allows recorded data to be adjusted for instrument calibration drift and sensor-



**Figure 6.** Turbidity values at the Little Arkansas River at Highway 50 near Halstead, Kansas, October 2003.



**Figure 7.** Turbidity values at the North Fork Ninnescah River above Cheney Reservoir, Kansas, October 2004.

fouling errors that occurred during the interval between servicing visits because of environmental or instrumentation effects, and for other factors such as cross-section variability or calculated parameters (that is, chlorophyll *a* from fluorescence measurements). Errors occur primarily from fouling of sensors and from sensor calibration drift. A data correction is required when the combined absolute values for fouling and calibration drift error exceed the criterion for water-quality data corrections (table 10):

$$E_T = |E_f| + |E_d|, \tag{1}$$

where

- $E_T$  = total error,
- $E_f$  = sensor fouling error, and
- $E_d$  = calibration drift error.

For example, if the fouling error for a DO sensor is +0.2 mg/L and the calibration error (the theoretical value for 100-percent DO saturation and actual reading in 100-percent DO saturation) is -0.2 mg/L, the sum of the absolute value of the errors (0.4 mg/L) exceeds the data-correction criterion for DO ( $\pm 0.3$  mg/L; table 10). Thus, the data must be corrected.

These data-correction criteria are minimum requirements for data corrections. More stringent data-correction criteria may be needed to meet the data objectives of the project or

**Table 10.** Criteria for water-quality data corrections.

[ $\pm$ , plus or minus value shown;  $^{\circ}\text{C}$ , degree Celsius;  $\mu\text{S}/\text{cm}$ , microsiemens per centimeter at 25  $^{\circ}\text{C}$ ; mg/L, milligram per liter; pH unit, standard pH unit; turbidity unit is dependent on the type of meter used]

Measured field parameter	Data-correction criteria (apply correction when the sum of the absolute values for fouling and calibration drift error exceeds the value listed)
Temperature (may affect other field parameters)	$\pm 0.2$ $^{\circ}\text{C}$
Specific conductance	$\pm 5$ $\mu\text{S}/\text{cm}$ or $\pm 3\%$ of the measured value, whichever is greater
Dissolved oxygen	$\pm 0.3$ mg/L
pH	$\pm 0.2$ pH unit
Turbidity	$\pm 0.5$ turbidity units or $\pm 5\%$ of the measured value, whichever is greater

specific hydrologic and chemical environments. The decision to apply data corrections when total errors are smaller than the data-correction criteria or to correct for other factors, such as cross-section or vertical variability, is left to the professional judgment of the hydrographer.

The data-correction procedure is the same whether the site is serviced using the standard protocol under steady-state or rapidly changing environmental conditions. However, if environmental conditions change slowly (without fluctuating) during servicing, the procedure for determining data corrections for sensor fouling varies slightly to account for the change in environmental conditions. Methods for applying data corrections are described in detail below.

All data corrections have a starting date and time and an ending date and time that delineate the data correction interval. A data correction period typically begins and ends on a servicing date. Calibration drift is assumed to occur at a constant rate throughout the correction period. Sensor fouling commonly begins as soon as the sonde is deployed in the aquatic environment; however, if certain environmental or hydrologic events, such as a rise in gage height (affecting turbidity, for example) or increase in temperature (affecting DO, for example), can be identified as significant fouling events, the event may be used as the start or end date for a

fouling correction. Thus, a zero correction is applied at the start of the correction interval, the full correction is applied at the end of the correction interval, and corrections to the data between the start and end dates are linearly interpolated (Bartholoma, 2005).

Data corrections sometimes are started at a time in between site visits. An example of a case in which a specific conductance record was affected by fouling that begins to severely affect the record occurred on March 21 (fig. 8). A data correction was applied to the record that began with a zero correction on March 21 and culminated in an 18-percent correction on April 1 at 1300 hours.

Data corrections for fouling, calibration drift, and cross-section variability are based on measurements made during servicing or cross-section surveys. In ADAPS, corrections are applied using one of three data-correction sets (Bartholoma, 2005). Data-correction set one is for sensor fouling, data-correction set two is for calibration drift, and data-correction set three is for “other” data adjustments. Each data-correction set may be used to apply constant data corrections, or one-, two-, or three-point variable data corrections (Bartholoma, 2005). Variable data corrections are prorated by time over the correction interval. Two- and three-point variable data corrections also are prorated by amount of correction over the

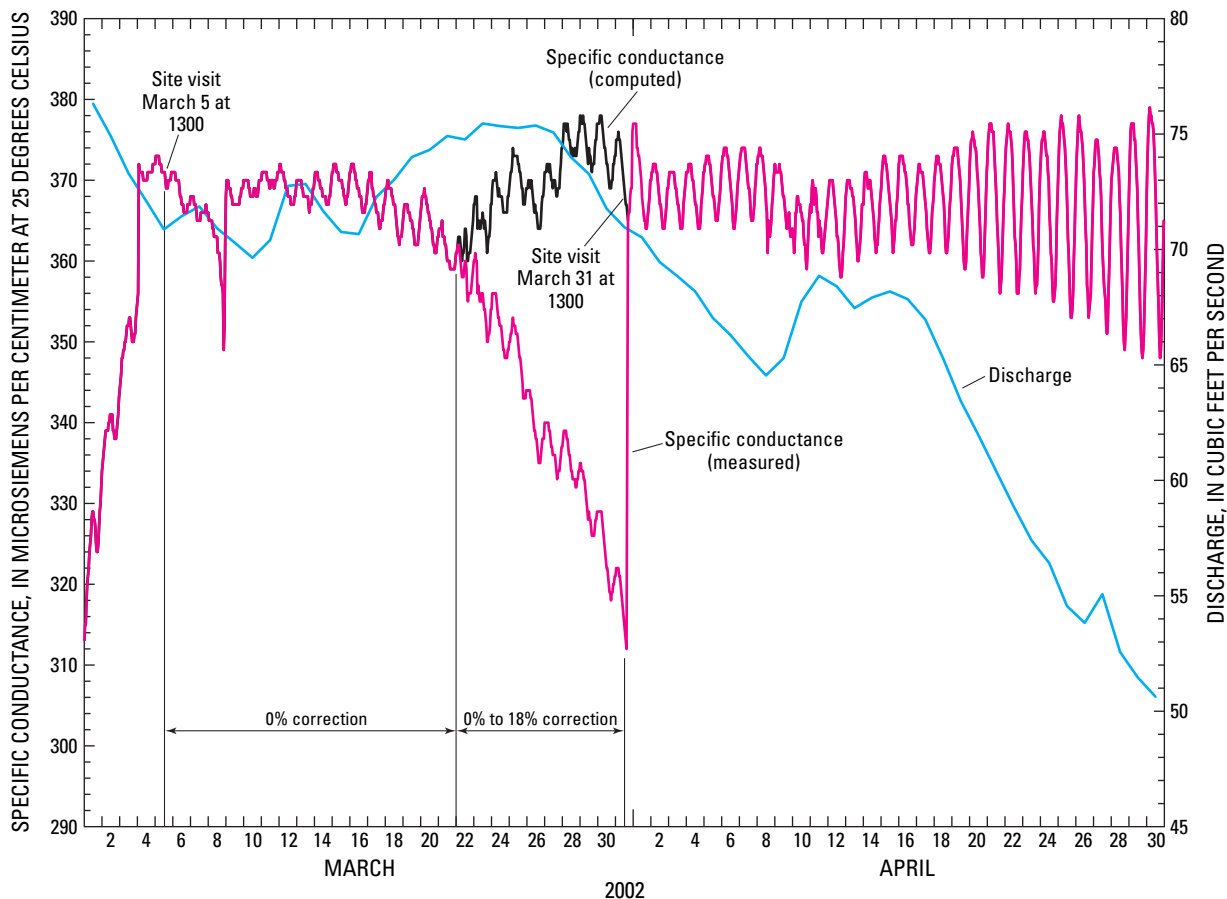


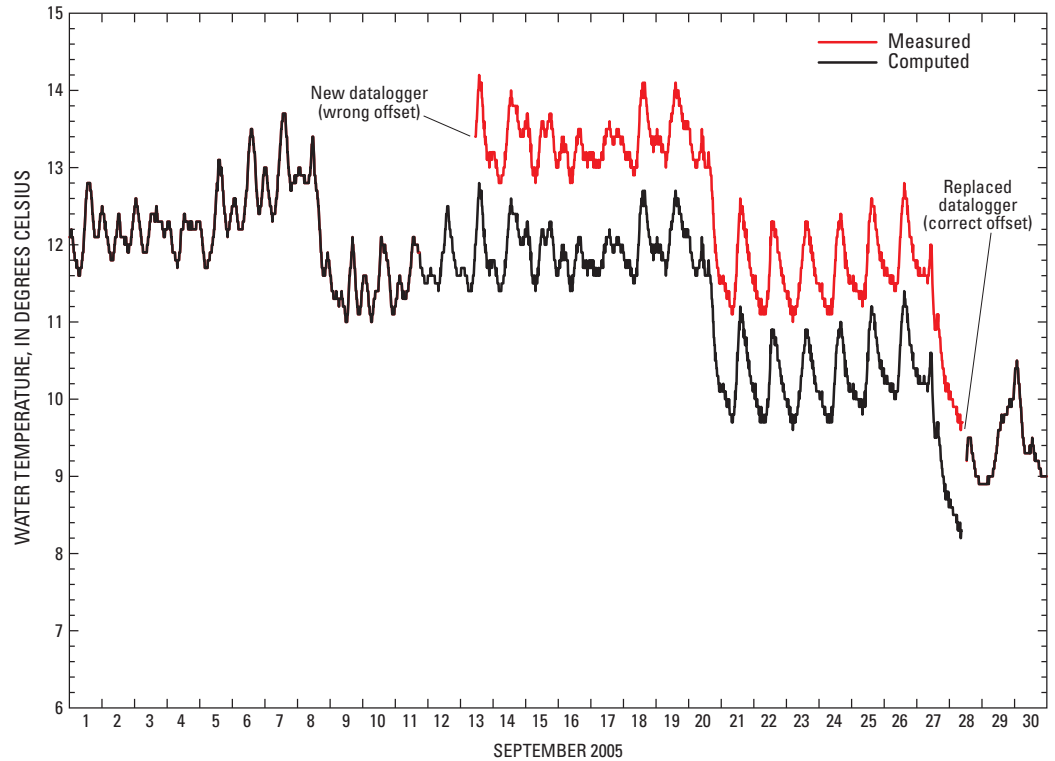
Figure 8. Example of fouling of specific conductance sensor.

range of recorded values and may be based on absolute error or percentage error.

A constant data correction is rarely used for water-quality records but could be appropriate if, for example, it was known that an error in calibration caused recorded values to be in error by a constant, known amount. Each recorded value would be adjusted by a single, constant value within the correction period. An example of a situation that needed a constant correction occurred at South Fork Tolt River near Carnation, Washington, when a new data logger was installed and incorrectly programmed with an offset that resulted in a +1.4 difference in recorded temperatures (fig. 9). A constant data correction is applied in ADAPS by entering an input and correction pair with a starting date (table 11; fig. 9). To designate that the correction continues over time without proration, the same input and correction pair are entered as an additional correction with the ending date as the starting date. This is immediately followed by a new correction pair of 0.0, which resets the correction to zero.

Most often, a one- or two-point variable data correction is needed. For variable data corrections, the amount of correction is prorated by time over the correction interval. For two-point variable data corrections, the amount of correction also is prorated over the range of recorded values. When the range of recorded values is small, a one-point variable data correction is used to linearly interpolate the amount of correction

from zero at the beginning of the correction interval to its maximum value at the end of the correction interval. For example, a calibration drift or fouling correction of -50 to a specific conductance value of 500  $\mu\text{S}/\text{cm}$  is not unusual. This one-point variable data correction would be prorated



**Figure 9.** Example of a constant data correction of -1.4 degrees Celsius applied in September 2005 to correct for programming error that produced an incorrect offset at South Fork Tolt River (12148000) near Carnation, Washington.

**Table 11.** Example of a constant data correction.

[USGS, U.S. Geological Survey; WA, Washington; C, Celsius; CORR, correction; PDT, Pacific Daylight Time zone]

```

CORRECTION SET      2
USGS 12148000      SOUTH FORK TOLT RIVER NEAR CARNATION, WA
Temperature, water, in degrees C                                WATER YEAR: 2005
      DATES VALID FROM: 10/01/2004 00:00 TO 09/30/2005 23:59
Enter one of the commands from the menu
*****
START DATE TIME DATUM   INPUT    CORR    INPUT    CORR    INPUT    CORR
END   DATE TIME DATUM   COMMENT
6:2005/09/13 1045 PDT      0.0     0.0
   /_/_
7:2005/09/13 1100 PDT      0.0    -1.4
   /_/_
8:2005/09/28 1030 PDT      0.0    -1.4
   /_/_
9:2005/09/28 1115 PDT      0.0     0.0
   /_/_
    
```



over time, beginning with a correction of zero at the start of the interval and ending with a correction of  $-50$ . One-point variable data corrections are applied in ADAPS by entering one pair of input and correction values for the beginning and another pair of input and correction values for the end of the correction period (table 12).

**Table 12.** Example of a one-point variable data correction.

[USGS, U.S. Geological Survey; US, United States; Specific cond, specific conductance;  $\mu\text{S}/\text{cm}$  @ 25C, microsiemens per centimeter at 25 degrees Celsius; CORR, correction; PRV, previous; PDT, Pacific Daylight Time zone]

```

USGS 12345000          ANYWHERE RIVER AT ANYTOWN, US
Specific cond at 25C, in  $\mu\text{S}/\text{cm}$  @ 25C          WATER YEAR: 2005
      DATES VALID FROM: 10/01/2004 00:00 TO 09/30/2005 23:59
Enter one of the commands from the menu
*****
START DATE TIME DATUM  INPUT  CORR  INPUT  CORR  INPUT  CORR
END   DATE TIME DATUM  COMMENT
PRV: None

-----
1:2005/05/06 1040 PDT      0      0      _____
   /_/_/_____ activated sonde
2:2005/06/03 1225 PDT      0     -50      _____
   /_/_/_____ fouling correction
3:2005/06/03 1233 PDT      0      0      _____
   /_/_/_____ after cleaning
-----
    
```

Past practice in the USGS has been to apply one-point variable data corrections to water-quality records; however, such a correction would have a significant and unintended effect on the corrected record if the range of recorded measurements was large. In the previous example, if specific conductance were to drop as low as  $100 \mu\text{S}/\text{cm}$  toward the end of the correction period when the correction was near its maximum ( $-50$ ), the correction would result in an adjusted value of about  $50 \mu\text{S}/\text{cm}$ —a 50-percent adjustment. The more accurate approach when the range of recorded values is large is to apply a data correction based on percentage error. This is a two-point variable data correction based on percentage error.

When the range of recorded values is large, a two-point correction is used to (1) linearly interpolate the amount of the correction by time from zero at the beginning of the correction period to the maximum value at the end of the correction period, and (2) linearly interpolate the amount of the correction, based on percentage error, over the range of recorded values. In the above example, a maximum  $-10$ -percent correction ( $-50$  divided by 500) is applied to recorded measurements so that a  $100\text{-}\mu\text{S}/\text{cm}$  value recorded near the end of the correction period is adjusted by about 10 percent to  $90 \mu\text{S}/\text{cm}$ . The validity of this concept is most evident for environmental extremes, such as  $0^\circ\text{C}$  or zero DO, when one-point variable data corrections may give unreasonable (negative) results compared to two-point variable data

corrections based on percentage. It is recommended that a percentage error approach be used for all specific conductance records and for temperature, DO, or turbidity records that have a large range of environmental sensor values. Most pH records have a small range of environmental values, and a one-point variable data correction is appropriate with little or no loss in accuracy.

Two-point variable data corrections based on percentage error are applied in ADAPS by using two input and correction pairs for the beginning and two input and correction pairs for the end of the correction period that bracket the range of recorded values during the correction interval (table 13). To apply the  $-10$ -percent data correction in the previous example, assuming recorded data range between 50 and  $1,000 \mu\text{S}/\text{cm}$ , two data-correction pairs (0; 0) and (1,000; 0) are entered into correction set 1 in line 1 to indicate a zero correction

for the range 0 to  $1,000 \mu\text{S}/\text{cm}$  at the beginning of the service interval, and two data-correction pairs (0; 0) and (1,000;  $-100$ ) are entered in line 2 to indicate a  $-10$ -percent correction for the range 0 to  $1,000 \mu\text{S}/\text{cm}$  for the end of the correction period (table 13). The third line contains two input pairs that reset the data corrections to zero, representing the cleaned sensor and the start of a new data-correction period.

A three-point variable data correction is used when a data correction is required because the sensor response is not linear, as determined by calibration checks. Specific conductance, temperature, DO, turbidity, and pH sensors are designed by the manufacturer to respond linearly. The linearity of temperature sensors is nearly synonymous with accuracy. Modern specific conductance sensors, for example, are designed by the manufacturer to read zero in air, and DO sensors are designed to read zero in an oxygen-free environment (in nitrogen gas or oxygen-free water). The slope of sensor response from zero is linear for specific conductance and DO. Even though the pH scale is logarithmic, pH sensors are set to pH-7 at zero millivolts and are designed to respond on a linear millivolts scale that is translated to standard pH units. Some turbidity sensors have calibration internally set by the manufacturer; whether preset or calibrated by the user, however, turbidity sensors are calibrated in the field with a zero-turbidity solution and one or two higher calibration standard solutions such that the sensor responds linearly in the range of environmental values. The

**Table 13.** Example of a two-point variable data correction based on percentage error.

[USGS, U.S. Geological Survey; WA, Washington; Specific cond, specific conductance;  $\mu\text{S}/\text{cm}$  @ 25C, microsiemens per centimeter at 25 degrees Celsius; CORR, correction; PRV, previous; PDT, Pacific Daylight Time zone]

```

CORRECTION SET      1
USGS 13351000      PALOUSE RIVER AT HOOPER, WA
Specific cond at 25C, in  $\mu\text{S}/\text{cm}$  @ 25C      WATER YEAR: 2002
DATES VALID FROM: 10/01/2001 00:00 TO 09/30/2002 23:59
Enter one of the commands from the menu
*****
START DATE TIME DATUM  INPUT  CORR  INPUT  CORR  INPUT  CORR
END  DATE TIME DATUM  COMMENT
PRV: None
-----
1:2002/05/06 1040 PDT      0      0      1000      0      _____
   /_/_/  _____  activated sonde
2:2002/06/03 1225 PDT      0      0      1000     -100     _____
   /_/_/  _____  fouling correction
3:2002/06/03 1233 PDT      0      0      1000      0      _____
   /_/_/  _____  after cleaning
-----

```

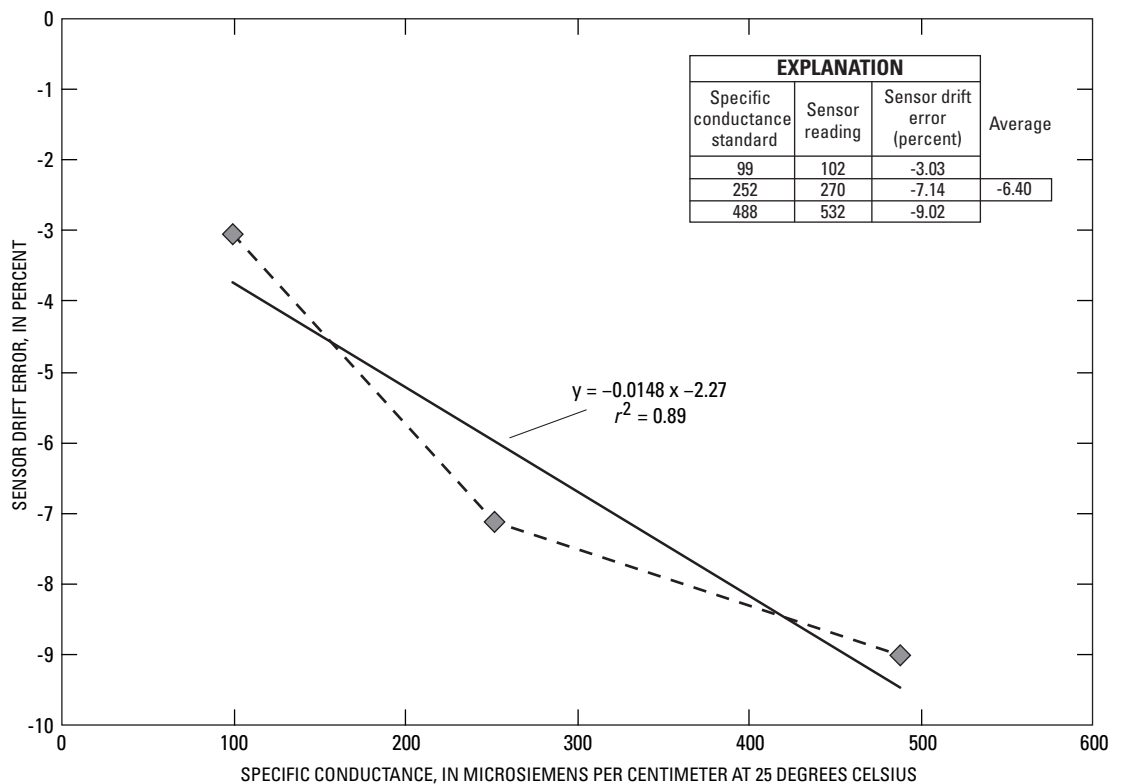
in Radtke and others (2004). Linear response of turbidity sensors can be examined by comparing sensor readings in three standard solutions. Sensor linearity of pH electrodes is measured by the electrode response in millivolts (slope), which can be read on some continuous water-quality monitors. Because DO can only be checked for calibration at zero and saturation, this method is not useful for testing the linearity of DO sensor response.

A three-point variable data correction is applied in ADAPS similarly to the two-point variable data correction

linear response of sensors is an important factor in considering how data corrections should be applied to continuous water-quality records. When sensor calibration response is nonlinear, strong consideration should be given to replacing the sensor.

except that three input and correction pairs are entered into the ADAPS data correction set to describe the nonlinear relation of the sensor response to calibration. An example of a three-point variable data correction is shown graphically in

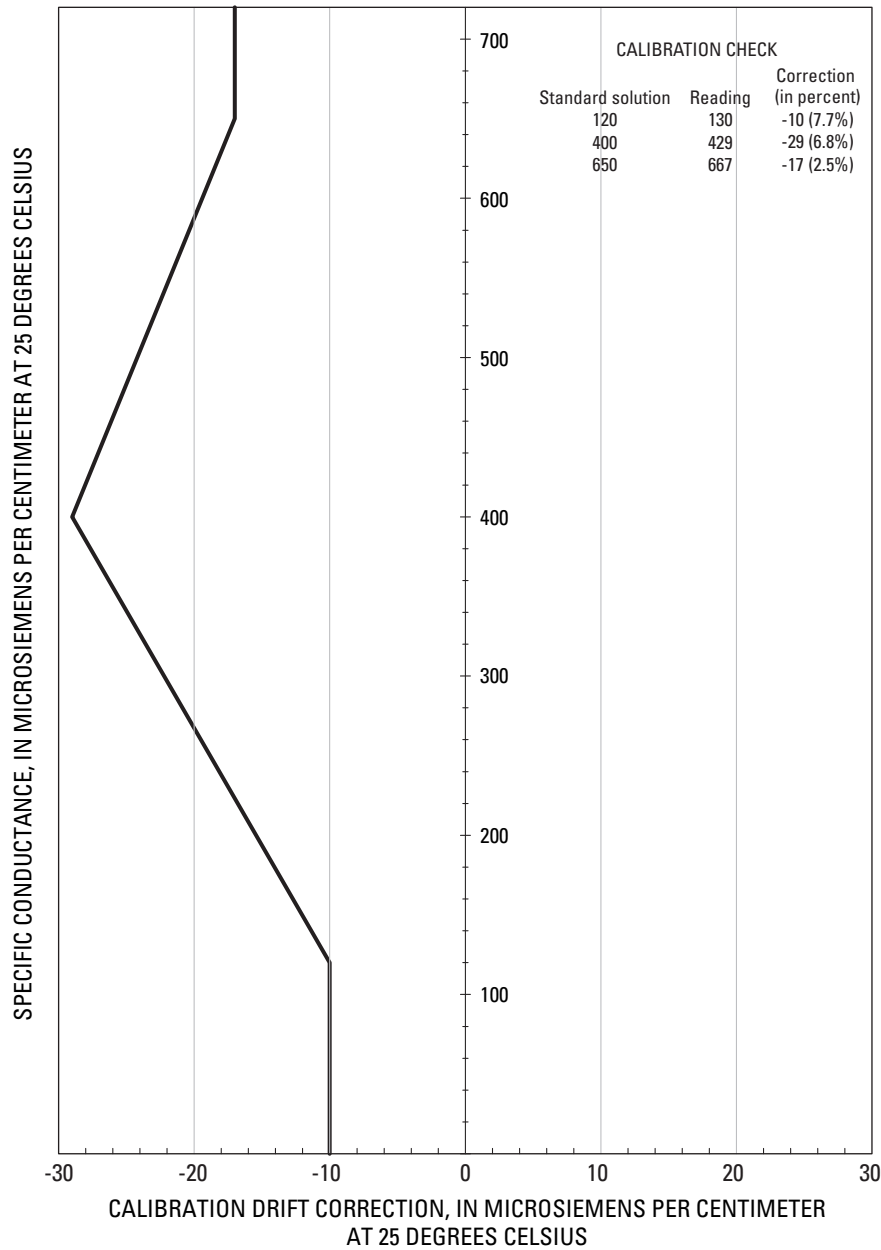
An example of specific conductance sensor response (fig. 10) shows how the response linearity can be quantified using linear regression. In general, if the coefficient of determination ( $r^2$ ) of the regression is less than 90 percent ( $r^2$  less than 0.90), a three-point variable data correction may be warranted; however, care should be used with this method because linear regression can give misleading results when the regression line is defined by only three data points. Linearity of temperature sensor response can be examined by comparing the sensor at five points with an NIST-traceable mercury-in-glass thermometer as described



**Figure 10.** Linearity of specific conductance sensor response, Palouse River at Hooper, Washington, September 10, 2002, showing best-fit regression.

figure 11. Two standards have calibration errors that exceed the data-correction criteria ( $\pm 5 \mu\text{S/cm}$  or  $\pm 3$  percent of the measured value, table 10). The third standard has a calibration error (2.5 percent) that does not exceed the data correction criteria. In figure 11 and table 14, corrections are shown for all three standards. The quality of the record at  $667 \mu\text{S/cm}$  and greater is excellent (see *Publication Criteria*) and does

not require a data correction, but applying a correction for the range between 429 and  $667 \mu\text{S/cm}$  does affect the record. Thus, it is necessary to apply a correction for the value of  $667 \mu\text{S/cm}$  in order to correct data for the range between 429 and  $667 \mu\text{S/cm}$ . The hydrographer and reviewers must use knowledge and experience in making decisions about when to apply data correction.



**Figure 11.** Graphic representation of a three-point data correction for nonlinear calibration drift.



**Table 14.** Example of a three-point variable data correction for nonlinear calibration drift.

[USGS, U.S. Geological Survey; US, United States; Specific cond, specific conductance;  $\mu\text{S}/\text{cm}$  @ 25C, microsiemens per centimeter at 25 degrees Celsius; CORR, correction; PRV, previous; PDT, Pacific Daylight Time zone]

```

CORRECTION SET 2
USGS 12345000 ANYWHERE RIVER AT ANYTOWN,US
Specific cond at 25C, in  $\mu\text{S}/\text{cm}$  @ 25C WATER YEAR: 2005
DATES VALID FROM: 10/01/2001 00:00 TO 09/30/2002 23:59
Enter one of the commands from the menu
*****
START DATE TIME DATUM INPUT CORR INPUT CORR INPUT CORR
END DATE TIME DATUM COMMENT
PRV: None
-----
1:2001/10/04 1515 PDT 130 0 429 0 667 0
 /_/_/___
-----
2:2001/11/07 1525 PDT 130 -10 429 -29 667 -17
 /_/_/___
-----
3:2001/11/07 1530 PDT 130 0 429 0 667 0
 /_/_/___
-----

```

**Corrections for Fouling**

Sensor-fouling error can result from a variety of sources and is determined by the difference between sensor measurements in the environment before and after the sensors are cleaned. Assuming steady-state conditions in the environment in which the sensor is being checked, the calculation for fouling error is as follows:

$$E_f = M_a - M_b, \tag{2}$$

where

- $E_f$  = sensor fouling error,
- $M_a$  = monitor reading after the sensor is cleaned, and
- $M_b$  = monitor reading before the sensor is cleaned.

Environmental conditions rarely are stable. Water temperature, pH, and DO often have daily cycles based on thermal warming and cooling, biological photosynthesis, and respiration. Field parameters also change in response to dilution or input from upstream tributaries, ground-water discharge or recharge, and precipitation. If environmental conditions change while the monitor is being serviced but do not fluctuate, the fouling error must be determined by modifying equation 2 to account for the change in the environment during servicing:

$$E_f = (M_a - M_b) - (F_e - F_s), \tag{3}$$

where

- $E_f$  = sensor fouling error,
- $M_a$  = monitor reading after the sensor is cleaned,
- $M_b$  = monitor reading before the sensor is cleaned,
- $F_s$  = field meter reading at the start of servicing, and
- $F_e$  = field meter reading at the end of servicing.

(Because  $(F_e - F_s) = 0$  when field readings do not change during servicing, equation 3 reduces to equation 2 under steady-state conditions.) For example, if the DO sensor reading before cleaning is 10.2 mg/L, and the sensor reading after cleaning is 10.4 mg/L, and the field meter changes during the servicing period from 10.6 to 10.3 mg/L (without any fluctuations), the fouling error, using equation 3, is as follows:

$$\begin{aligned}
 E_f &= (10.4 - 10.2) - (10.3 - 10.6) \\
 E_f &= (0.2) - (-0.3) \\
 E_f &= 0.5
 \end{aligned}$$

Notice that the *apparent* change in the sensor readings of 0.2 mg/L (from 10.2 to 10.4 mg/L) when the sensor is cleaned is less than the actual fouling error of 0.5 mg/L when the environmental change is factored in.

Fouling is assumed to occur at a constant rate and typically is assumed to begin at the start of the service interval when the sensor was last cleaned. It may be possible, however,

to identify a specific event, such as a rise in stream stage, change in temperature, or sudden change in sensor reading that marks the onset of fouling. From equation 1, if the absolute value of the fouling error ( $E_f$ ) plus the absolute value of the calibration drift error ( $E_d$ ; described below) exceed the data-correction criteria (table 10), a data correction is required. Because fouling takes place gradually, it typically is prorated from the start to end date of the correction period as illustrated in figure 12 for specific conductance. ADAPS data-correction set 1 (sensor fouling) should be used for applying fouling data corrections.

If the range in environmental values is small, a one-point variable data correction may be appropriate. When using a one-point variable data correction, the fouling correction equals the fouling error:

$$C_f = E_f = (M_a - M_b) - (F_e - F_s), \quad (4)$$

where

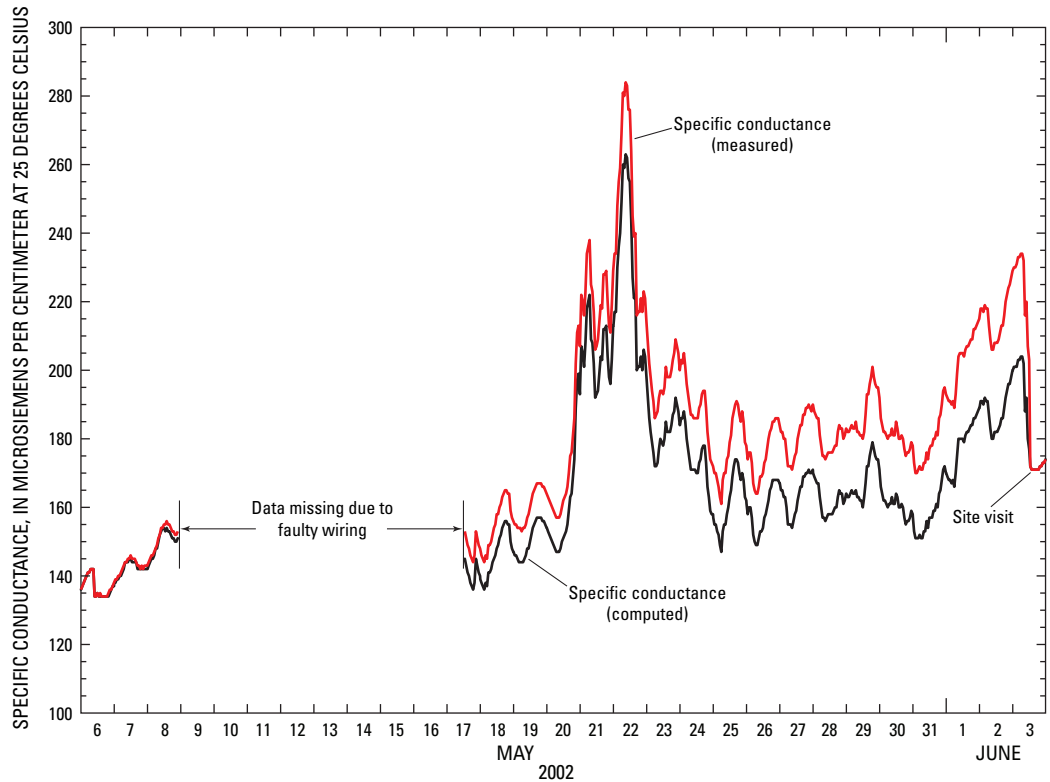
- $C_f$  = fouling correction,
- $E_f$  = fouling error,
- $M_a$  = monitor reading after the sensor is cleaned,
- $M_b$  = monitor reading before the sensor is cleaned,
- $F_s$  = field meter reading at the start of servicing, and
- $F_e$  = field meter reading at the end of servicing.

For example, if the DO sensor reading before cleaning is 10.1 mg/L, and the sensor reading after cleaning is 10.5 mg/L, and the field meter reading is 10.6 mg/L during the servicing period (without change), the data correction for fouling, using equation 4, is as follows:

$$C_f = (10.5 - 10.1) - (10.6 - 10.6)$$

$$C_f = 0.4$$

Record computation can be simplified by inserting this equation into a spreadsheet and using the spreadsheet as a



**Figure 12.** Data corrections for fouling of a specific conductance sensor at Palouse River at Hooper, Washington, May–June 2002.

measurement summary form (Attachment 3). In this example, the fouling correction exceeds the data-correction criteria.

When the range of values is large over the service interval, it is appropriate to apply a two-point variable data correction based on percentage error:

$$\%C_f = 100 \left( \frac{(M_a - M_b) - (F_e - F_s)}{M_b} \right), \quad (5)$$

where

- $\%C_f$  = fouling correction, in percent,
- $M_a$  = monitor reading after the sensor is cleaned,
- $M_b$  = monitor reading before the sensor is cleaned,
- $F_s$  = field meter reading at the start of servicing, and
- $F_e$  = field meter reading at the end of servicing.

To calculate the percentage error using the above example and equation 5:

$$\%C_f = 100 \left( \frac{(10.5 - 10.1) - (10.6 - 10.6)}{10.1} \right)$$

$$\%C_f = 100 \left( \frac{(0.4) - (0)}{10.1} \right)$$

$$\%C_f = 4.0$$

Modern temperature sensors provide continuous temperature corrections to specific conductance, DO, pH, and turbidity values, all of which are temperature dependent. Because of the complex interdependencies of temperature and these other measured field parameters, a malfunctioning thermistor can invalidate some or all of the other recorded field parameters. DO concentrations, for example, change 3 percent for each temperature change of 1 °C (Lewis, 2005). Specific conductance also can vary as much as 3 percent per 1 °C. Thus, the record for a faulty temperature sensor may have to be deleted along with associated records that depend on the temperature sensor, such as DO, pH, and specific conductance. It is fortunate that temperature sensors are the least prone to fouling of any sensor. The fouling data correction for temperature sensors, if needed, typically is a one-point variable data correction; however, if the range in environmental values of temperature is large, a two-point variable data correction based on percentage error may be more appropriate.

In general, specific conductance sensors are sturdy, easy to clean, and reliable. The fouling correction recommended for specific conductance generally is a two-point variable data correction based on percentage error.

The DO fouling error correction for the appropriate part of the service interval when fouling occurred generally is a one-point variable data correction in ADAPS. If a large range in DO concentrations was recorded, however, a two-point variable data correction based on percentage error may be more appropriate. The determination of onset and magnitude of fouling error for DO may range from straight forward (for example, onset of a flood) to complex (for example, gradual growth of an algal coating).

A fouling correction for turbidity generally is applied as a one-point variable data correction. If the range in values of turbidity is large, however, a two-point variable data correction based on percentage error may be more appropriate. The optic mechanism on the turbidity sensor is extremely sensitive to accumulation of sediment or algae. If a turbidity sensor is equipped with a wiper or shutter that is properly maintained, the need for a fouling correction can be minimized.

Continuous records of DO and turbidity often are the most difficult to maintain within acceptable limits for accuracy and precision because of the susceptibility of these sensors to fouling. The time between service visits may need to be shortened to maintain adequate quality of the DO or turbidity record.

Fouling of a pH sensor can be similar to the fouling of a DO membrane. The pH sensor must be cleaned delicately in order to avoid scratching the glass surface. The recommended data correction for pH fouling is a one-point variable data correction.

## Corrections for Calibration Drift

Calibration drift error is the result of an electronic drift in the sensor reading from the last time the sensor was calibrated and is determined by the difference between cleaned-sensor readings in standard solutions or buffers and the true, temperature-compensated value of the standard solution or buffer. Using the formula that describes the standard protocol for slowly changing conditions, the percentage correction is as follows:

$$E_d = V_s - V_c, \quad (6)$$

where

- $E_d$  = calibration drift error,
- $V_s$  = value of a calibration standard solution or buffer of known quality (for DO, the standard value is represented by the DO 100-percent saturation value), and,
- $V_c$  = sensor reading in the calibration standard solution.

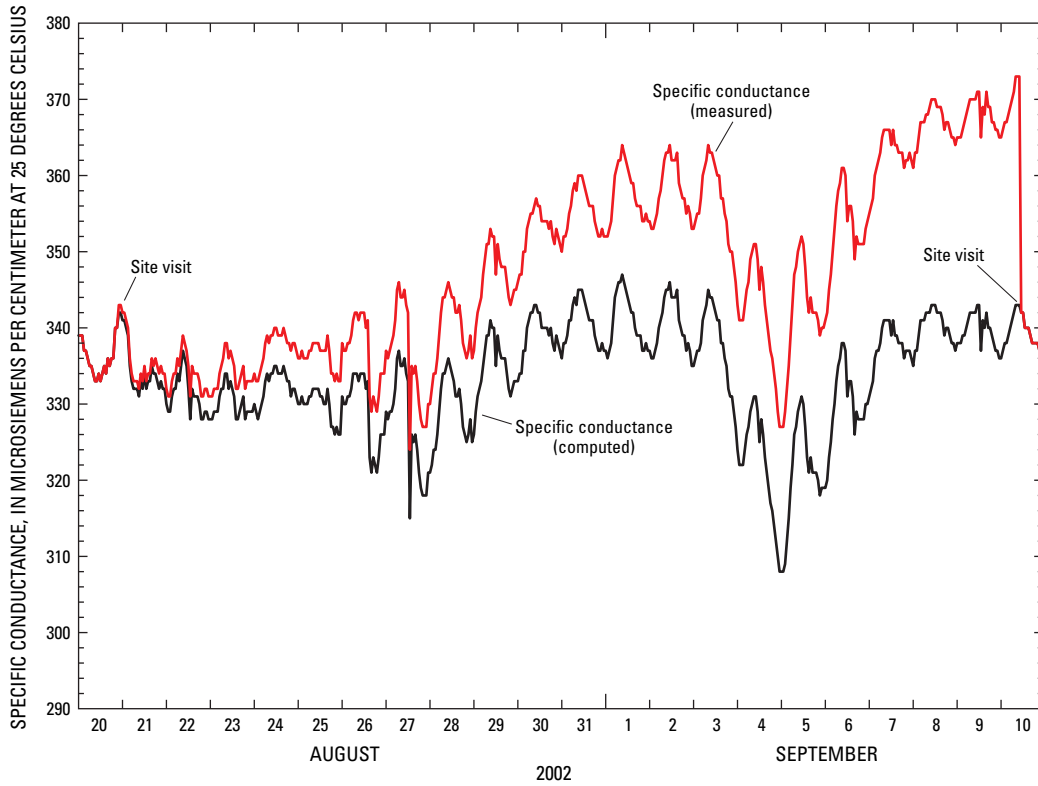
Calibration drift is assumed to occur at a constant rate during the service interval. If the calibration drift plus fouling error is within the data-correction criteria (table 10), corrections are not required, but if the calibration drift plus fouling error exceeds the data-correction criteria (table 10), a correction is required. ADAPS data-correction set two (calibration drift) should be used to apply calibration drift data corrections (table 14). Before any corrections are made, proper operation of the monitor must be verified for correct calibration ranges, sufficient battery voltage, and any other variables that may affect operation. The calibration drift correction equals calibration drift error and is computed as follows:

$$C_d = E_d = V_s - V_c, \quad (7)$$

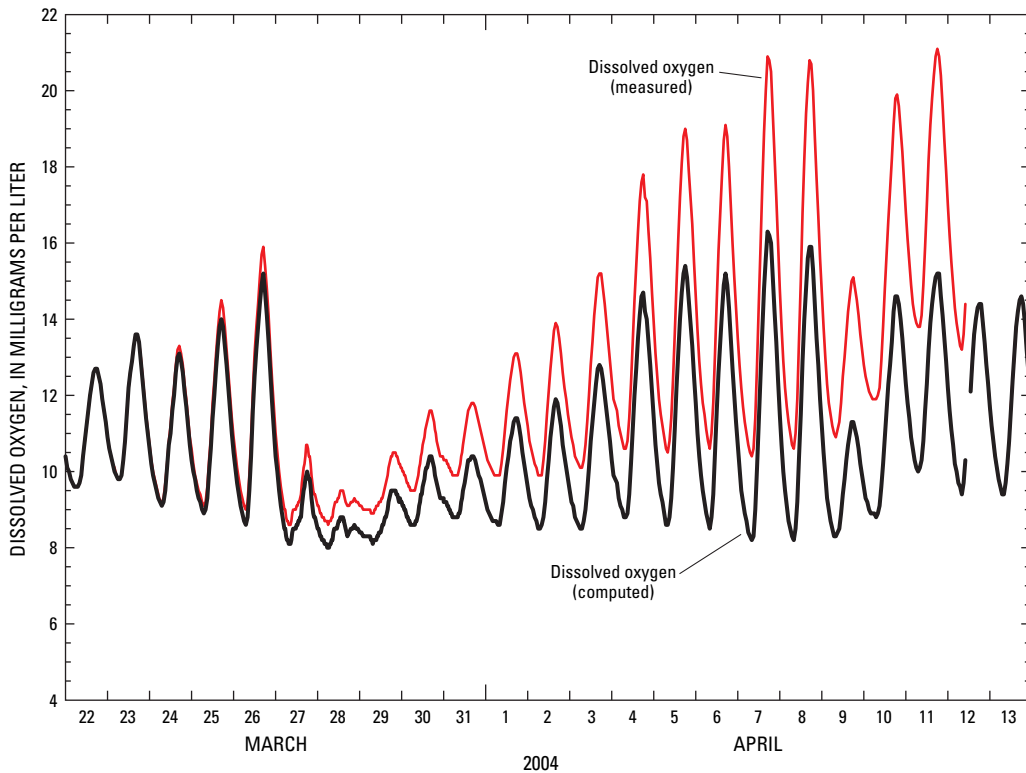
where

- $C_d$  = calibration drift correction
- $E_d$  = calibration drift error,
- $V_s$  = value of a calibration standard solution or buffer of known quality (for DO, the standard value is represented by the DO 100-percent saturation value), and,
- $V_c$  = sensor reading in the calibration standard solution.

When the correction is applied as a linear interpolation over the correction interval, it is called a two-point variable data correction in ADAPS (Bartholoma, 2005) and is illustrated for specific conductance in figure 13 and for DO in figure 14.



**Figure 13.** Two-point variable data correction for calibration drift of a specific conductance sensor at Palouse River at Hooper, Washington, August–September 2002.



**Figure 14.** Two-point variable data correction for calibration drift of a dissolved oxygen sensor at Little Arkansas River near Sedgwick, Kansas, March–April 2004.

If the range in recorded values is small, a one-point variable data correction may be appropriate. As with fouling corrections, however, the appropriate data correction for calibration drift generally is a two-point variable data correction based on percentage error such that

$$\%C_d = 100\left(\frac{V_s - V_c}{V_c}\right), \quad (8)$$

where

- $V_s$  = value of a calibration standard solution or buffer of known quality (for DO, the standard value is represented by the DO 100-percent saturation value), and
- $V_c$  = sensor reading in the calibration standard solution.

If calibration checks with NIST-traceable calibration standard solutions or buffers verify that sensor response is not linear, the sensor may be faulty and may need to be repaired or replaced. Linearity of sensor response can be graphically displayed by plotting observed sensor response against actual values of the standards; for example, observed specific conductance sensor response can be plotted against specific conductance standard solution values, as described earlier and shown in figure 10. Similar plots of sensor response can be displayed for any field parameter that is measured with three or more standard solutions (or observations, in the case of temperature comparisons). If the sensor response is not linear, a three-point variable data correction should be used rather than a one- or two-point variable data correction.

To apply a three-point variable data correction, three pairs of data corrections must be entered in ADAPS as value adjustments for a measured field parameter (table 14). This value-dependent correction is applied in situations where, at the beginning and/or ending of the correction interval, sensor calibration percentage error is different for different standards, which reflects a nonlinear sensor response. The equivalent situation for computation of streamflow in ADAPS is called a variable shift (Bartholoma, 2005). A graphic representation of a three-point variable data correction based on percentage error for specific conductance calibration is shown in figure 11. Three-point variable data correction can be used for any field parameter and is the recommended technique for corrections related to instrument calibration drift if the sensor response is not linear. Use of a three-point variable data correction implies that the sensor response is not linear. Calibration data that reflect nonlinear sensor response may be caused by a malfunctioning sensor, contaminated standard solutions, or errors in calibration. Careful attention should be given to correcting potential errors and observing sensor

response during subsequent servicing. If the sensor response continues to be nonlinear, consideration should be given to replacing the sensor. Improvements in electronic devices in the past two decades have greatly reduced the amount of true electronic calibration drift.

## Other Corrections

The most common “other” data corrections to continuous water-quality records are adjustments to stream water-quality records based on correlations between point measurements and cross-section average measurements. This category of data corrections also may be appropriate for data corrections that involve ancillary laboratory measurements, such as chlorophyll sensors or in-situ nitrate analyzers. Cross-section corrections may not be applicable for environments with poor mixing, upstream tributaries, point and nonpoint discharges, or other natural conditions that negate the use of cross-section corrections. In these environments it can be extremely difficult, if not impossible, to characterize variability with any degree of confidence or predictability. For these reasons, cross-section corrections may not be applicable for urban sites monitored for regulatory compliance or for sites that have widely varying coefficients that have no consistency or predictability. Project or data-quality objectives may require that measured values at the sonde location be adjusted because of variability in measured values in the cross section or because of a significant difference between values recorded at the sonde location and average or median values measured in the cross section. Such cross-section adjustments may be needed to provide better estimates of constituent loads or regression estimates (Christensen and others, 2000), or simply to provide more accurate calculated values if the water-quality monitor cannot be located at a point that is representative of the stream. If the variability of discharge-weighted values of measured field parameters compared to the measured values at the sonde locations exceeds the data-correction criteria (table 10), cross-section data correction may be needed (see *Evaluation of Cross-Section Data Corrections*). ADAPS data-correction set three (other) should be used for other data corrections, such as cross-section corrections. The analysis and statistical summaries of cross-section variability should be documented in the annual station analysis (see *Station Analysis*).

## Evaluation of Cross-Section Data Corrections

If the measurement point is not representative of the stream, the measurement point should be relocated to a more representative measuring point in the cross section. If a representative measuring point cannot be found, consideration should be given to moving the monitor to a better site. Location of the monitoring site, however, may be required for regulatory reasons, cooperator’s objectives, or other

data-quality objectives. Another option that should be considered before applying cross-section corrections is downgrading the rating of accuracy for a monitoring record (see *Publication Criteria*). If cross-section data show that the site is not representative of particular flows or seasons, these particular portions of the record could be downgraded in ratings of accuracy. Professional judgment and observations in the field logs will aid in evaluating the need for the application of cross-section corrections. Details for application of cross-section corrections are described in Attachment 4.

### Computation of Salinity

The separate data processing of both specific conductance and salinity records is time consuming and can lead to errors. Salinity should be calculated from fully processed and corrected continuous specific conductance records. If specific conductance values have been compensated to 25 °C and water depths are sufficiently shallow making pressure corrections unnecessary, salinity can be calculated from processed specific conductance records using standard equations. Schemel (2001), following principles of the 1978 Practical Salinity Scale, simplified the general equation for salinity (S) described by Lewis (1980) for the case of a single temperature (25 °C) and atmospheric pressure (760 mm):

$$S = K_1 + (K_2 \times R^{1/2}) + (K_3 \times R) + (K_4 \times R^{3/2}) + (K_5 \times R^2) + (K_6 \times R^{5/2}), \quad (9)$$

where

$$\begin{aligned} K_1 &= 0.0120, \\ K_2 &= -0.2174, \\ K_3 &= 25.3283, \\ K_4 &= 13.7714, \\ K_5 &= -6.4788, \text{ and} \\ K_6 &= 2.5842. \end{aligned}$$

The variable R is the ratio of specific conductance at 25 °C to standard seawater (salinity equals 35) at 25 °C (53.087 millisiemens per centimeter). Salinity expressed by PSS is a dimensionless value, although it is commonly reported as practical salinity units and is nearly equivalent to parts per thousand.

Salinity can be processed from corrected specific conductance records and entered into the NWIS ADAPS database (Bartholoma, 2005) using a rating table. The following 30-point rating table (table 15) defines the conversion of specific conductance in microsiemens per centimeter to salinity in practical salinity units for measurements at atmospheric pressure (Schemel, 2001).

Before the development of the Practical Salinity Scale, salinity commonly was reported in parts per thousand. The values in practical salinity units and parts per thousand are nearly equivalent. The following 30-point rating table (table 16) defines the conversion of specific conductance in microsiemens per centimeter to salinity in parts per thousand for measurements at atmospheric pressure (Miller and others, 1988).

**Table 15.** Rating table for conversion of specific conductance, in microsiemens per centimeter, to salinity, in practical salinity units.

[µS/cm, microsiemens per centimeter at 25 degrees Celsius; psu, practical salinity units; (90860), ADAPS parameter code for salinity in psu]

Specific conductance, in µS/cm	Salinity, in psu (90860)	Specific conductance, in µS/cm	Salinity, in psu (90860)	Specific conductance, in µS/cm	Salinity, in psu (90860)
100	0.046	11,000	6.233	38,000	24.099
300	0.142	13,000	7.464	41,000	26.220
500	0.240	15,000	8.714	44,000	28.364
700	0.340	17,000	9.981	47,000	30.532
1,000	0.492	20,000	11.911	50,000	32.722
2,000	1.016	23,000	13.873	53,000	34.935
3,800	2.001	26,000	15.865	56,000	37.172
5,000	2.679	29,000	17.885	59,000	39.430
7,000	3.836	32,000	19.931	62,000	41.712
9,000	5.022	35,000	22.003	65,000	44.016



**Table 16.** Rating table for conversion of specific conductance, in microsiemens per centimeter, to salinity, in parts per thousand.[ $\mu\text{S/cm}$ , microsiemens per centimeter at 25 degrees Celsius; ppt, parts per thousand; (00480), ADAPS parameter code for salinity in ppt]

Specific conductance, in $\mu\text{S/cm}$	Salinity, in ppt (00480)	Specific conductance, in $\mu\text{S/cm}$	Salinity, in ppt (00480)	Specific conductance, in $\mu\text{S/cm}$	Salinity, in ppt (00480)
100	0.040	11,000	6.229	38,000	24.124
300	0.131	13,000	7.463	41,000	26.252
500	0.226	15,000	8.714	44,000	28.405
700	0.324	17,000	9.983	47,000	30.582
1,000	0.474	20,000	11.914	50,000	32.783
2,000	0.997	23,000	13.878	53,000	35.008
3,800	1.984	26,000	15.872	56,000	37.257
5,000	2.664	29,000	17.895	59,000	39.530
7,000	3.826	32,000	19.945	62,000	41.826
9,000	5.016	35,000	22.022	65,000	44.146

## Computation of Percentage of Dissolved Oxygen Saturation

Many sondes equipped with DO sensors also may record DO percentage of saturation values that are calculated by the sonde software. The separate processing of records for both continuous DO and continuous DO percentage of saturation is time consuming and can lead to inconsistent data corrections between the two records. If data corrections are applied to the DO record, similar corrections must be applied to the DO percentage of saturation record. The USGS recommends that DO percentage of saturation be calculated from fully processed and corrected continuous records of DO, temperature, and specific conductance. This calculation can be facilitated by using computer programs specifically developed to use ADAPS-computed DO records to calculate DO percentage of saturation using the equations of Weiss (1970). The programs and instructions required for this process are posted for USGS personnel at <http://sr.water.usgs.gov/qw/qwmonitors/>.

## Final Data Evaluation

Final data evaluation consists of reviewing the data record, checking data corrections, and making any needed final corrections. When review is completed, the data are verified for publication and rated for quality. Data that cannot be verified or are rated as unacceptable are retained for record checking and review purposes but are not published or stored in ADAPS (except in raw or measured format). All data must be archived following policies established in the quality-assurance plan of each Water Science Center.

## Maximum Allowable Limits for Reporting Continuous Data

Systematic adoption of a standardized final data-evaluation process, including maximum allowable limits and

publication criteria, are important components in finalizing a Water Science Center's water-quality records. Many USGS Water Science Centers have established quality-control limits for correcting data. These commonly are referred to as "maximum allowable limits." The concept is simple: if the recorded values differ from the corrected values by more than the maximum allowable limits, the corrected data are not reported or stored in the database. For consistency within the USGS and to inform data users of the maximum allowable limits, the limits are established at 6–10 times the calibration criteria for all standard continuous-monitoring data-collection activities (table 17).

**Table 17.** Maximum allowable limits for continuous water-quality monitoring sensors.

[ $\pm$ , plus or minus value shown;  $^{\circ}\text{C}$ , degree Celsius; %, percent; mg/L, milligram per liter; pH unit, standard pH unit. Data corrections that exceed the maximum allowable limits should not be stored in the database]

Measured field parameter	Maximum allowable limits for water-quality sensor values
Temperature	$\pm 2.0$ $^{\circ}\text{C}$
Specific conductance	$\pm 30\%$
Dissolved oxygen	$\pm 2.0$ mg/L or 20%, whichever is greater
pH	$\pm 2$ pH units
Turbidity	$\pm 3.0$ turbidity units or $\pm 30\%$ , whichever is greater

The maximum allowable limits shown in table 17 are considered minimum standards, and Water Science Centers are encouraged to establish stricter requirements. Even with the establishment of maximum allowable limits, professional judgment by the hydrographer is still needed in record

processing. For example, a decision must be made regarding at what point in the data-collection interval the error-correction value exceeded the maximum allowable limit. Tools, such as the ADAPS “Display expanded shifts and corrections (SHIFT\_TABLE)” described by Bartholoma (2005), can assist the hydrographer in identifying this point (see *Publication Criteria*). In the cases of calibration drift, gradual fouling, or event-related fouling, reasonable judgment can be made regarding the time in the record interval when the maximum allowable limits were exceeded. The hydrographer computing the record and the record reviewer must agree on this determination and note the time when the maximum allowable limits were exceeded on the station analysis sheet. Values between this point and the end of the data-correction interval should not be published.

It generally is understood that the more publishable record there is for a site, the more consistently the data objectives can be met for accuracy and precision. Therefore, it follows that it may take some time to finalize the appropriate intervals between service visits at new installations to minimize inaccurate data and missing record. Decisions about the costs of more frequent service visits in relation to potential decreases in accuracy and precision in the record must be considered carefully for every water-quality monitoring site in relation to various seasons and flows.

**Publication Criteria**

An assessment of the overall accuracy of the record is required for the publication of all continuous water-quality records in the USGS annual data reports or in other publication formats. The accuracy rating is based on data values recorded before any data corrections are made (table 18). After the record has been evaluated and data corrections applied (based on table 10), one of four accuracy classifications

ranging from excellent to poor is applied to each measured field parameter.

The accuracy of the daily record can be calculated in some cases by using the SHIFT\_TABLE program in ADAPS, as described by Bartholoma (2005). Accuracy ratings that are measured in concentration or applicable units (water temperature, pH, and perhaps DO or turbidity) can be applied directly by using the expanded shift and corrections for the range of environmental concentrations or values during the period of the rating record. Details for this procedure and for ratings that are measured in percentages are described in Attachment 5.

Additional consideration for rating the accuracy of the record must be based on an assessment of the amount of publishable record, the amount of data that have been corrected, and the quality-control (or lack of) data used during the monitor operation. The amount of publishable record indicates how well the instrument or sensor functioned during the period of record. Less confidence should be placed in a record that has frequent data gaps or insufficient quality-control data. A record that requires frequent, substantial data corrections may indicate that sensor fouling is a major source of error, or the sensor has calibration-stability problems. Downgrading the quality of the record may be appropriate in cases of frequent data gaps. Missing data or data that do not meet the criteria for maximum allowable limits may have a varied range of effects on the accuracy of the published data, depending on the situation; the decision to publish the data is left to the professional judgment of the hydrographer. To publish a daily value for any field parameter, the following minimum requirements apply:

1. To publish a daily mean or median value on days when less than 100 percent of the discrete time interval data are collected, both the expected daily maximum and minimum values must be present. Reporting daily mean values when less than 100 percent of the unit values are available is a decision based on professional judgment of the

**Table 18.** Accuracy ratings of continuous water-quality records.

[≤, less than or equal to; ±, plus or minus value shown; °C, degree Celsius; >, greater than; %, percent; mg/L, milligram per liter; pH unit, standard pH unit]

Measured field parameter	Ratings of accuracy (based on combined fouling and calibration drift corrections applied to the record)			
	Excellent	Good	Fair	Poor
Water temperature	≤±0.2 °C	>±0.2–0.5 °C	>±0.5–0.8 °C	>±0.8 °C
Specific conductance	≤±3%	>±3–10%	>±10–15%	>±15 %
Dissolved oxygen	≤±0.3 mg/L or ≤±5%, whichever is greater	>±0.3–0.5 mg/L or >±5–10%, whichever is greater	>±0.5–0.8 mg/L or >±10–15%, whichever is greater	>±0.8 mg/L or >±15%, whichever is greater
pH	≤±0.2 units	>±0.2–0.5 units	>±0.5–0.8 units	>±0.8 units
Turbidity	≤±0.5 turbidity units or ≤±5%, whichever is greater	>±0.5–1.0 turbidity units or >±5–10%, whichever is greater	>±1.0–1.5 turbidity units or >±10–15%, whichever is greater	>±1.5 turbidity units or >±15%, whichever is greater

hydrographer and generally is determined by data trends, knowledge of site characteristics, and the influence of hydrologic events.

2. Daily maximum and minimum values may be published independently if they occur during the expected times and if the reported values can reasonably be expected to be the true extremes (Novak, 1985). Additionally, there must be sufficient adjacent values to confirm that the value is a daily extreme, and there should be no inflows or effluents upstream from the sensor that would disrupt a normal daily pattern. The proportion of missing data should not be the sole criterion for publication, but knowledge of site characteristics and the consequences of flow and hydrologic events on the measured field parameters should be taken into consideration in defining measured extremes of the physical phenomena being measured. The following criteria are suggested as a starting point for making decisions on publishing daily extremes:

- **Water temperature**—Presence of a minimum of 25 percent of the unit values, and flow that is gradually changing or at a steady state.
- **Specific conductance**—Presence of a minimum of 50 percent of the unit values, and flow that is gradually changing or at a steady state. Consider the relation of specific conductance to streamflow.
- **Dissolved oxygen**—Presence of a minimum of 25 percent of the unit values, and flow that is gradually changing or at a steady state. Consider the relation of dissolved oxygen to temperature and pH.
- **pH**—Presence of a minimum of 25 percent of the unit values, and flow that is gradually changing or at a steady state.
- **Turbidity**—Presence of a minimum of 50 percent of the unit values, and flow that is gradually changing or at a steady state. Consider the relation of turbidity to specific conductance and streamflow.

The current station-description format for the USGS annual data report requires a description of the specific service interval ratings (Novak, 1985). The record-rating system described in table 18 must be systematically applied to all continuous water-quality monitoring data published in USGS reports. Accuracy ratings are listed in the “REMARKS” section of the manuscript for USGS annual data reports (see *Data Reports*). The appropriate rating and accuracy of each water-quality monitoring record also must be included on the station analysis form (see *Preparation of the Review Package*).

The calculation of daily mean pH values in ADAPS should be discontinued in USGS water-quality data-collection programs and replaced by the calculation of median daily pH values or a more accurate computational method for calculating mean pH values. The correct calculation involves the

conversion of pH units to hydrogen-ion activity, calculation of a mean activity value, and conversion back to pH units, as described by Radtke and others (2003).

## Preparation of the Review Package

Typically, the same individual who services the water-quality monitoring station also computes the water-quality monitoring record, writes the water-quality station analysis that describes annual operation of the station, makes necessary changes in the station description, and prepares a package of auxiliary information to aid in the review of the record.

## Record Checking

All data used in producing the final water-quality record must be checked thoroughly for completeness and accuracy before final review and publication. The hydrographer who is responsible for computing the water-quality record should review the record, followed by a second independent review for completeness and accuracy by an experienced hydrographer. All field data must be verified for accuracy of transcription from field sheets; all data corrections must be checked to assure that the correct values were used for a data correction; and all dates and numbers in the station manuscript must be checked for accuracy. Final inspection and review of the water-quality record should be made by the USGS Water Science Center water-quality specialist or designated reviewer.

## Station Description

Specific information about each field site (station) is documented in a station description (Attachment 6). The station description contains specific information about the station location, history, and operation and should be placed in a protective field folder and carried into the field. Any changes in location, instrumentation, operation, or land use must be recorded in the station description. For some stations, service intervals may be a week or less to meet data-quality objectives. The measurement frequency must be included in the station description and in the USGS annual data report manuscript, as described by Novak (1985). At sites that also have a streamflow gage, this information can be merged with the existing gaging-station description. A complete description is prepared for each new station and is revised only when changes in location occur or when changes are substantial enough to affect how the continuous monitor is operated or how the data are interpreted. Although the contents of a continuous water-quality station description can vary, the station description must include the following at a minimum:

- Location of station
- Station history
- Drainage area (including basin characteristics)

- Channel characteristics (including any unique or unusual features of the installation)
- Station description, equipment, and benchmarks
- Methods for making discharge and water-quality measurements
- Historical extremes
- Cross-section surveys (discharge and water quality)
- Purpose and cooperation
- Maps, photographs, and permits
- Safety hazards, detailed road log, and access remarks
- Date and initials of preparer and reviewer(s)

The station description should enable a person unfamiliar with the site to find the site, know what equipment was used and for what periods, and where sensors are and were located throughout the history of the site. A person should also be able to track major land-use changes that may affect the continuous water-quality data at the site based on information in the station description (Attachment 6).

## Station Analysis

Each continuous-monitoring station requires an annual station analysis (Attachment 7). The purpose of the station analysis is to document conditions at the site, how the record was compiled and manipulated, and how this information was used in analyzing the accuracy and completeness of the record for the water year. Information from field notes, instrument logs, ADAPS output, and the station description are used to evaluate the accuracy and completeness of the record. Records of cross-section surveys and extreme values must be updated annually in the station analysis (Attachment 7), and analysis of cross-section statistical summaries must be included in the station analysis as part of the data-evaluation process. At a minimum, the station analysis must include the following:

- **Sampling location**—Station name and number, year, field parameter measured, and measurement frequency
- **Instrumentation**—Type of monitoring sensor(s) and recorder, location of sensor(s) or intakes, any other special instrumentation or features, and dates sensors were changed or replaced
- **Published records**—Identification of the field parameter that is published, as well as any data that are collected and not published
- **Site characteristics**—Brief description of the composition of the channel and any unique or unusual features that may affect the quality of the record

- **Record**—Statement of the completeness of the record and how the raw measured record is decoded or manipulated to provide the constituent values used to compute the final records (Note all missing data and the reason it is missing. Include any data that are collected but not published. Include the final rating of accuracy for the period of record (or specific service intervals) in chronological order.)
- **Calibration**—How and when the instrument was calibrated or checked, including statement if corrections were needed for the data
- **Computations**—Statement of how corrections were applied to the data, a list of extreme correction values that were applied to the recorded values during the year, and causes for correction(s) (Any treatment of unusual or atypical data should be documented.)
- **Cross-section surveys**—How, where, and when the cross section was measured, the number of verticals, and the amount of variation throughout the cross section (State whether the location of the sensor(s) or water-supply intake is representative of the stream.)
- **Vertical profiles**—How, where, and when the vertical profile was measured, the number and depth of measurements, and the amount of variation throughout the profile (State whether the location of the sensor(s) or water-supply intake is representative of the stream.)
- **Remarks**—Any additional information about the site, data collected, or general statements that do not fit in any other section
- **Date and name (or initials)**—Identity of preparer and reviewer(s)

The station analysis should enable a reviewer to reconstruct what happened at the site, how the record was processed, why data corrections were applied, and the reasoning behind the accuracy ratings assigned.

## Documentation

The USGS methods for collecting, correcting, and processing continuous water-quality monitoring data have been defined, and USGS publication standards have been established. Systematic application of monitoring-station operation, the record-rating system, and a standard record-review process are part of the necessary quality assurance in producing and documenting complete and accurate water-quality monitoring records. The use of DECODES for data conversion and ADAPS for data processing ensures national consistency and a valid data trail. Additionally, participation in the USGS National Field Quality Assurance (NFQA) Program (Stanley and others, 1998) ensures the proficiency of

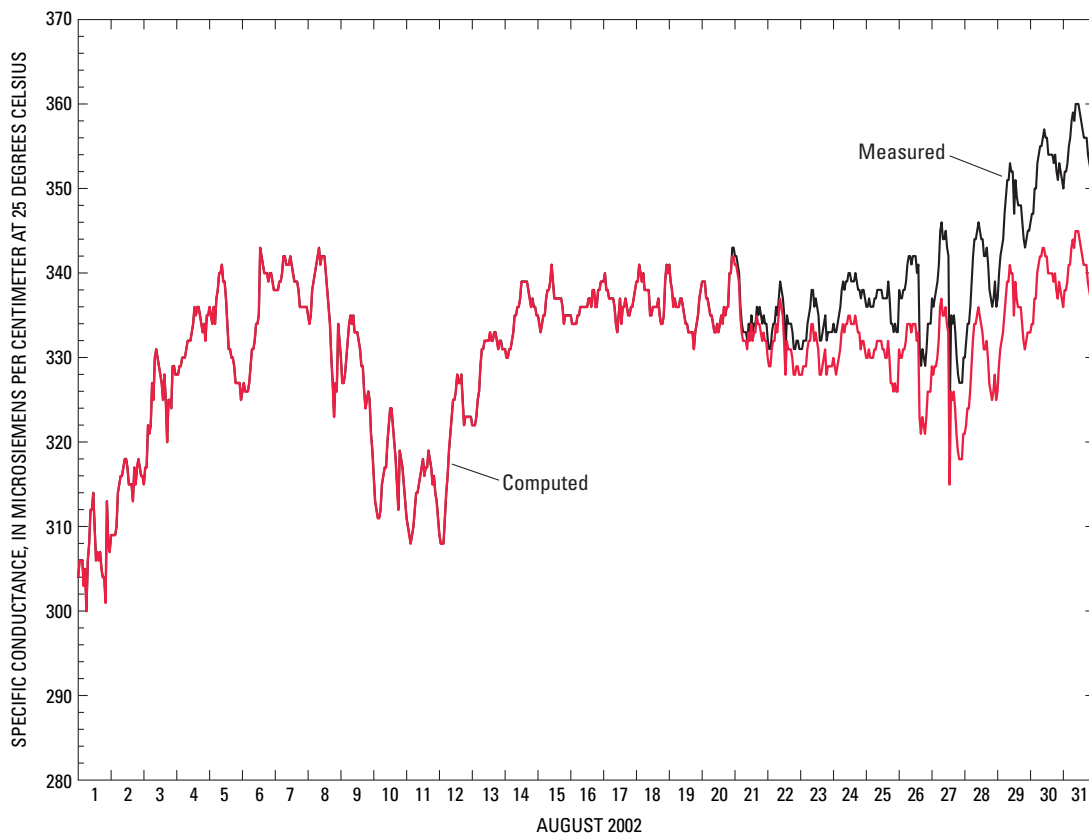
the analyst and the instruments used in making measurements. Participation in the NFQA Program provides additional required documentation of field-instrument accuracy and reliability of the instruments used in making measurements.

## Level of Review Required

At a minimum, the record-review package is examined annually for completeness and accuracy by a second individual (a senior colleague or section supervisor). If real-time data are transmitted to the Internet, data should be reviewed more frequently (U.S. Geological Survey, 2000). The decisions must be documented in the review package if areas of interpretation exist (for example, when to start or terminate a data correction). The completed record-review package is then inspected by the Water Science Center water-quality specialist or designated reviewer for completeness and accuracy.

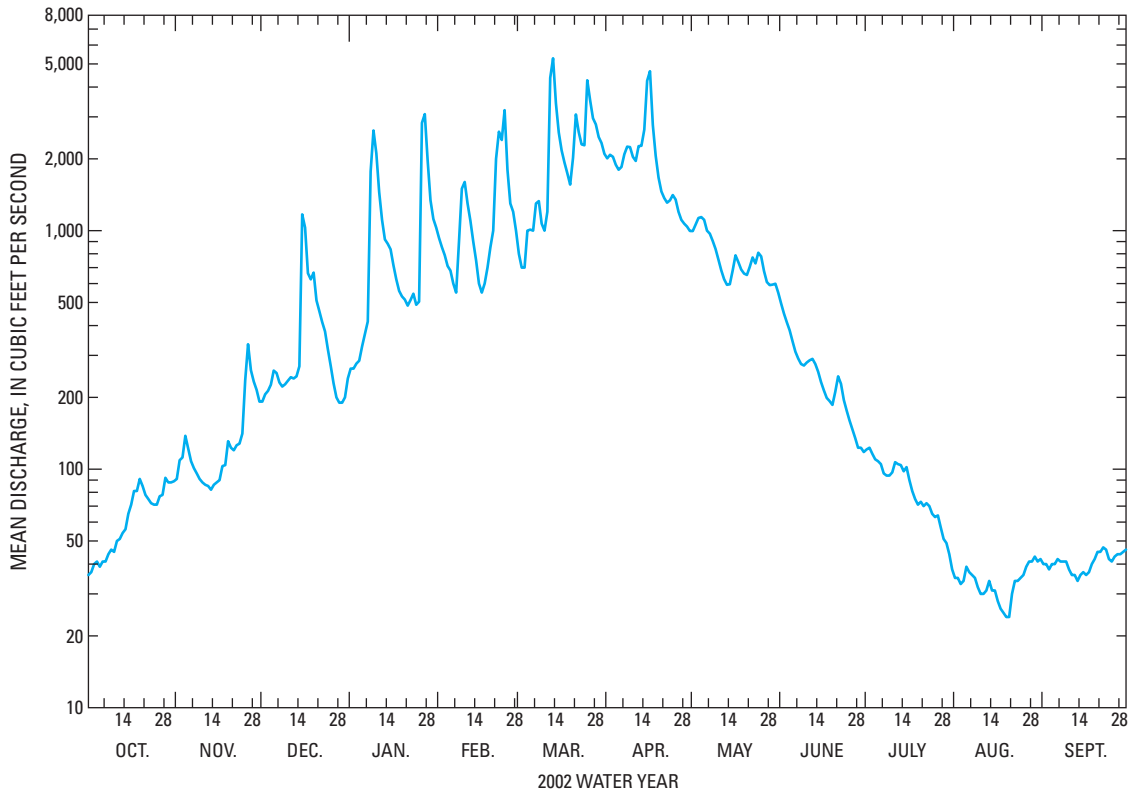
## Contents of the Review Package

Review of a continuous water-quality record requires analysis of tables of the measured field parameter; graphs of the measured field parameter (fig. 15); ancillary information, such as graphs of streamflow (fig. 16); graphs of related field parameters; and ancillary files used in making data corrections. Review of measured physical parameters is improved by analysis of the associated streamflow. Similarly, analysis of measured field parameters may be enhanced by review of related measured field parameters. For example, review of a continuous DO record may be enhanced by a graph of related continuous temperature record (fig. 17). The ADAPS station analysis, which provides a summary of all data corrections made during the year and lists all periods of missing record (table 19), is a useful report for the review process in addition to the ADAPS end-of-year table, which summarizes minimum and maximum field parameter values for the year (table 20). The data-calibration and correction criteria, maximum allowable limits, and ratings of accuracy have been combined into one table for easy reference in the record-computation and review process (Attachment 8).

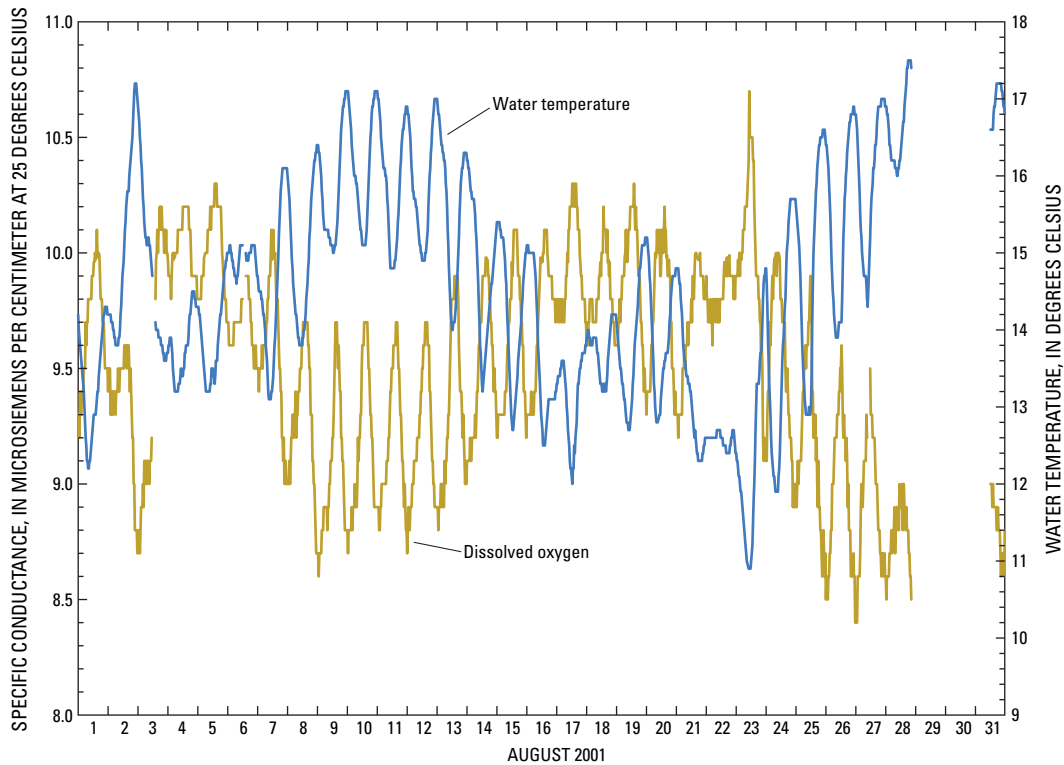


**Figure 15.** Example of a review graph of measured and computed values of specific conductance at Palouse River at Hooper, Washington, August 2002.





**Figure 16.** Example of a discharge hydrograph at U.S. Geological Survey streamgaging station 13351000, Palouse River at Hooper, Washington.



**Figure 17.** Example of a review graph of computed values of related water-quality field parameters at U.S. Geological Survey streamgaging station 12121500, Puyallup River at Puyallup, Washington, August 2001.



**Table 19.** Example of an ADAPS station analysis report.

[WA, Washington; USGS, U.S. Geological Survey; NAD27, North American Datum of 1927; NGVD29, National Geodetic Vertical Datum of 1929; cond, conductance; 25C, 25 degrees Celsius;  $\mu\text{S}/\text{cm}$  @ 25C, microsiemens per centimeter at 25 degrees Celsius; Corr, correction; PDT, Pacific Daylight Time zone]

U.S. DEPARTMENT OF THE INTERIOR - U.S. GEOLOGICAL SURVEY - WATER RESOURCES

STATION NUMBER 13351000 PALOUSE RIVER AT HOOPER, WA SOURCE AGENCY USGS STATE 53  
COUNTY 075

LATITUDE 464531 LONGITUDE 1180852 NAD27 DRAINAGE AREA 2500.00 CONTRIBUTING DRAINAGE  
AREA 2500 DATUM 1040.8 NGVD29

Date Processed: 2003-09-23 10:54 By rjwagner  
Station Analysis Report for Water Year 2002

Computation Type: daily values only

CORRECTIONS:

Specific cond at 25C, in  $\mu\text{S}/\text{cm}$  @ 25C

Correction set # 1

Start Date / End Date / Comments	SET	Input	Corr	Input	Corr	Input	Corr
2002/05/06 @ 10:40:00 PDT ----/--/-- @ --:--:-- activated onde	1	100	0	1000	0		
2002/06/03 @ 12:25:00 PDT ----/--/-- @ --:--:-- Fouling correction	1	0	0	1000	-130		
2002/06/03 @ 12:33:00 PDT ----/--/-- @ --:--:-- after cleaning	1	0	0	1000	0		
2002/09/10 @ 10:05:00 PDT ----/--/-- @ --:--:--	1	0	0	1000	0		
2002/10/01 @ 09:03:00 PDT ----/--/-- @ --:--:-- Fouling correction	1	0	0	1000	60		

Correction set # 2

Start Date / End Date / Comments	SET	Input	Corr	Input	Corr	Input	Corr
2002/08/20 @ 13:08:00 PDT ----/--/-- @ --:--:--	2	100	0	1000	0		
2002/09/10 @ 10:05:00 PDT ----/--/-- @ --:--:--	2	0	0	1000	-80		
2002/09/10 @ 10:09:00 PDT ----/--/-- @ --:--:--	2	0	0	1000	0		

Correction set # 3

RATINGS & SHIFTS:

DAILY VALUES

Gaps in Record  
10-01 To 04-23  
05-09 To 05-17

Estimated Record  
None

**Table 20.** Example of an ADAPS end-of-year summary report.

[WA, Washington; USGS, U.S. Geological Survey; NAD27, North American Datum of 1927; NGVD29, National Geodetic Vertical Datum of 1929; DD, data descriptor; cond, conductance; 25C, 25 degrees Celsius;  $\mu\text{S}/\text{cm}$  @ 25C, microsiemens per centimeter at 25 degrees Celsius; HH, hour; MM, minute; SS, second]

U.S. DEPARTMENT OF THE INTERIOR - U.S. GEOLOGICAL SURVEY - WATER RESOURCES		
STATION NUMBER 13351000 PALOUSE RIVER AT HOOPER, WA SOURCE AGENCY USGS		
STATE 53 COUNTY 075		
LATITUDE 464531 LONGITUDE 1180852 NAD27 DRAINAGE AREA 2500.00 CONTRIBUTING DRAINAGE		
AREA 2500 DATUM 1040.8 NGVD29		
Date Processed: 2005-07-01 13:29 By rjwagner		
INPUT DD: Specific cond at 25C, IN $\mu\text{S}/\text{cm}$ @ 25C		
PROVISIONAL DATA FOR WATER YEAR ENDING SEPT. 30, 2002		
ANNUAL MAXIMUM, BASED ON 159 EQUIVALENT DAYS OF RECORD.		
DATE	TIME HH MM SS	Specific cond at 25C ( $\mu\text{S}/\text{cm}$ @ 25C)
-----	-----	-----
MAXIMUM INSTANTANEOUS Specific cond at 25C		
09/30/2002	06:00:00	364
MINIMUM INSTANTANEOUS Specific cond at 25C		
04/02/2002	05:00:00	0
04/03/2002	00:00:00	0
MAXIMUM DAILY Specific cond at 25C		
09/29/2002		355
MINIMUM DAILY Specific cond at 25C		
05/06/2002		134

The record-review package includes the following figures, forms, or tables (examples are included in this report and in the accompanying attachments):

1. Station-description form (Attachment 6)
2. USGS water-quality monitor field-inspection forms (Attachment 1)
3. Annual field-measurement summary form (Attachment 3)
4. Unit-value graphs for review of each water-quality field parameter (figure 15)
5. Data correction for fouling table from ADAPS (for example, table 13)
6. Data correction for calibration drift table from ADAPS (for example, tables 11 and 14)
7. Water-quality three-point variable data-correction table from ADAPS (table 14)
8. Primary computations table from ADAPS (Attachment 2)
9. ADAPS output from “Expanded Shifts/Corrections” used to rate accuracy of record (Attachment 5)
10. Computed (type 3) daily-values tables (see *Data Reporting*)
11. Discharge hydrograph (figure 16)
12. ADAPS end-of-year summary (table 20)
13. ADAPS station analysis report (table 19)
14. Station analysis form (Attachment 7)
15. Draft manuscript station description for the USGS annual data report (see *Data Reporting*)

## Data Reporting

It is USGS policy that, with rare exception, all data collected by the USGS must be published or made publicly available. Although paper reports are the traditional means of publication, data are currently (2006) being made available

in other electronic formats, such as computer disks, compact disks-read only to memory (CD-ROMs), or on the Internet. The same requirements for checking the completeness and accuracy of the record apply to all forms of publication.

## Data Reports

All nonproprietary water-quality data collected during the water year are published in the USGS annual data report, “Water Resources Data, [State name], Water Year \_\_\_,” or in individual project data reports. Approval for publishing hydrologic data is in accordance with applicable USGS publication policies (Alt and Iseri, 1986; U.S. Geological Survey, 2003a, b). USGS policy (U.S. Department of the Interior, 1992) states that data and information are to be published; however, publication is not limited to paper media (U.S. Geological Survey, 1990; U.S. Department of the Interior, 1993). Electronic formats for public distribution include computer storage media, such as CD-ROMs and the Internet.

Long-term deployment of continuous water-quality monitors generates large amounts of unit-value data. Measurements of water-quality field parameters may be set to record from 24 to 96 unit values (or more) per day, producing more data values than can easily be published in data tables. Because environmental extremes in field parameters are important for understanding and describing biological processes and documenting adherence to regulatory criteria, it is desirable to publish both the daily minimum and maximum values of field parameters. Additionally, it is desirable to publish the daily statistical central tendency of unit values (mean or median). Thus, these measurements are processed statistically and published as daily records of minimum, maximum, and either mean or median (table 21). Measurements of pH should be published as minimum, maximum, and median (or mean hydrogen-ion activities can be calculated as described by Radtke and others, 2003). Because of the large variability commonly observed in measurements of turbidity, the decision to publish mean or median daily turbidity values depends on the project and data-quality objectives. It may not be appropriate to publish or calculate daily median, maximum, and minimum data for tidally influenced sites where the tidal period (about 24.2 hours) is superimposed on the daily period making daily statistics less meaningful.

**Table 21.** Example of an ADAPS daily-values table.

[WA, Washington; USGS, U.S. Geological Survey; NAD27, North American Datum of 1927; NGVD29, National Geodetic Vertical Datum of 1929; MAX, maximum; MIN, minimum; data shown only for June through September of 2002]

U.S. DEPARTMENT OF THE INTERIOR - U.S. GEOLOGICAL SURVEY - WATER RESOURCES												
STATION NUMBER 13351000 PALOUSE RIVER AT HOOPER, WA SOURCE AGENCY USGS STATE 53												
COUNTY 075 LATITUDE 464531 LONGITUDE 1180852 NAD27 DRAINAGE AREA 2500.00 CONTRIBUTING												
DRAINAGE AREA 2500 DATUM 1040.8 NGVD29												
Specific conductance, water, unfiltered, microsiemens per centimeter at 25 degrees Celsius												
WATER YEAR OCTOBER 2001 TO SEPTEMBER 2002												
DAY	MAX	MIN	MEAN	MAX	MIN	MEAN	MAX	MIN	MEAN	MAX	MIN	MEAN
	JUNE			JULY			AUGUST			SEPTEMBER		
1	189	166	178	287	279	282	314	300	307	347	336	341
2	200	180	188	293	287	289	318	309	315	346	335	340
3	204	171	184	293	290	291	331	315	325	345	324	338
4	181	174	178	299	290	294	336	328	333	331	308	322
5	192	181	186	300	288	293	341	325	333	331	308	321
6	198	180	192	297	289	293	343	326	335	338	319	330
7	201	197	198	305	294	298	342	335	339	341	331	338
8	208	196	205	308	292	299	343	323	336	343	335	340
9	211	207	209	297	288	294	335	316	329	343	336	340
10	215	208	211	293	284	288	324	311	317	343	336	340
11	220	214	215	292	286	289	319	308	314	343	335	338
12	221	213	217	295	288	291	328	308	320	344	335	340
13	222	216	219	304	295	300	333	322	330	345	338	341
14	225	204	222	310	303	306	339	330	335	344	338	341
15	232	206	223	314	308	311	341	333	336	344	338	342
16	239	222	232	314	308	311	339	334	336	347	339	344
17	243	228	237	314	308	311	340	333	336	349	342	345
18	242	222	235	315	310	313	341	334	338	351	344	349
19	243	223	237	318	309	314	341	331	335	355	348	352
20	248	228	242	319	311	315	342	333	336	357	348	353
21	250	223	239	322	304	316	341	330	334	354	331	346
22	241	221	235	322	312	317	337	328	331	331	306	318
23	250	241	244	322	309	316	334	328	330	311	302	307
24	273	250	261	319	303	312	335	328	332	316	308	311
25	282	269	275	317	303	310	332	326	330	321	309	316
26	274	257	264	317	303	310	334	321	329	328	317	323
27	269	260	266	317	306	311	337	315	327	344	325	338
28	275	269	273	320	310	314	336	321	329	355	343	353
29	276	271	274	325	311	318	341	326	335	363	355	360
30	281	274	277	324	304	315	343	333	339	364	354	361
31	---	---	---	317	304	311	345	336	341	---	---	---
MONTH	282	166	227	325	279	304	345	300	330	364	302	338

## Data-Qualification Statements

The accuracy of published water-quality monitoring records is defined by the rating of the record (see *Publication Criteria*; table 18), and this accuracy is indicated in a statement in the “REMARKS” paragraph of the manuscript station description (table 22). Different accuracies may be attributed to different parts of a given record. Additional comments regarding missing data and the quality of recorded data also may be noted in the “REMARKS” paragraph. For example, comments should be noted if daily extremes may have occurred during periods of missing record (see *Publication Criteria*; Novak, 1985).

## Reporting Parameter Codes and Units

All continuous time-series data must be stored in NWIS. Data from all temperature, specific conductance, pH, and DO sensors are essentially comparable and can be stored under the appropriate NWIS parameter code (table 23). (See “Data Rounding Convention” section in Bartholoma (2005) for a discussion of significant figures and rounding conventions in

data reporting.) Numerous methods and instruments can be used to measure turbidity. Because of differences in design and technology, Gray and Glysson (2003) suggest that a set of turbidity reporting units be used to differentiate between various instruments and methodologies. Turbidity data should be stored and reported in NWIS using parameter codes and measurement reporting units that are specific to the instrument type used (Anderson, 2004; table 23). Because ADAPS currently does not have the capability of storing method codes, as described by Anderson (2004), it is necessary to document the turbidity instrument make and model number in the ADAPS data descriptor (Bartholoma, 2005). It also is necessary to describe the turbidity instrument make and model in the instrumentation section of the station description and in the manuscript station description for the annual data report.

During intervals when recorded turbidity measurements are verified as exceeding the sensor-reporting limit because of stream turbidity, the daily maximum must be reported as greater than the manufacturer’s reporting limit or as greater than a value near the maximum sensor response that has been observed. For example, maximum turbidity measurements in figure 6 were observed at approximately 1,685 FNU.

**Table 22.** Example of a manuscript station description.

[WA, Washington; NAD27, North American Datum of 1927; °C, degree Celsius; mg/L, milligram per liter]

<p>PALOUSE RIVER BASIN</p> <p>13351000 PALOUSE RIVER AT HOOPER, WA (National Water-Quality Assessment station)</p> <p>WATER-QUALITY RECORDS</p>
<p>PERIOD OF RECORD.--Water years 1959-71, 1993-current year.</p>
<p>PERIOD OF DAILY RECORD.--</p> <p>SPECIFIC CONDUCTANCE: October 1961 to September 1971, August 1993 to September 1994, April 2002 to current year.</p> <p>WATER TEMPERATURE: October 1961 to September 1971, August 1993 to current year.</p> <p>SUSPENDED SEDIMENT DISCHARGE: October 1961 to September 1971, October 1992 to September 1999; November 2000 to March 2001 (discontinued).</p>
<p>INSTRUMENTATION.--Water-quality monitor since August 1993. Electronic data logger with 60-minute recording interval except for period Nov. 15, 1994, to Oct. 20, 1995, when the recording interval was 72 minutes.</p>
<p>REMARKS.--Specific conductance record excellent for the period except Aug. 5 to 18, which is good; and Apr. 1, May 19, June 2, 4, Sept. 29, which is fair. Temperature record excellent. In October 1996, station became a Central Columbia Plateau National Water-Quality Assessment Program (NAWQA) surface-water quality trend site.</p>
<p>EXTREMES FOR PERIOD OF DAILY RECORD.--</p> <p>SPECIFIC CONDUCTANCE: Maximum recorded, 447 microsiemens Aug. 14, 1994, but may have been higher during periods of missing record; minimum recorded, 131 microsiemens observed May 6, 2002, but may have been lower during periods of missing record.</p> <p>WATER TEMPERATURE: Maximum recorded 32.5 °C (rounded) July 24, 1994, but may have been higher during periods of missing record; minimum recorded, 0.0 °C for several days during winter months.</p> <p>SEDIMENT CONCENTRATION: Maximum daily mean, 10,100 mg/L Feb. 8, 1996; minimum daily mean, 1 mg/L Jan. 4, 2001.</p> <p>SEDIMENT DISCHARGE: Maximum daily, 527,000 tons Feb. 9, 1996; minimum daily, 0.04 tons Aug. 16, 20, 1994.</p>
<p>EXTREMES FOR CURRENT YEAR.--</p> <p>SPECIFIC CONDUCTANCE: Maximum 380 microsiemens Sept. 27; Minimum 88 microsiemens Feb. 2.</p> <p>WATER TEMPERATURE: Maximum 28.7 °C July 21; minimum, 0.2 °C Nov. 2</p>

**Table 23.** Parameter codes and reporting units for measured field parameters at water-quality monitoring sites.

[NWIS, National Water Information System; °C, degree Celsius; µS/cm, microsiemens per centimeter at 25 °C; mg/L, milligram per liter; FNU, formazin nephelometric units; FBU, formazin backscatter units; FNMU, formazin nephelometric multibeam units; >, greater than; <, less than; ppt, parts per thousand; psu, practical salinity units. Turbidity units are specified for each type of measurement instrument. All light wavelengths for turbidity methods have spectral output typically near infrared (780–900 nanometers)]

Field parameter	NWIS parameter code	Reporting units	Reporting conventions
Temperature	00010	°C	To nearest 0.1 °C.
Specific conductance	00095	µS/cm	Three significant figures, whole numbers only.
pH	00400	Standard pH units	To nearest 0.1 standard pH unit.
Dissolved oxygen	00300	mg/L	To nearest 0.1 mg/L.
Dissolved oxygen, percent saturation	00301	mg/L	To nearest whole number.
Turbidity, formazin nephelometric <sup>a</sup>	63680	FNU	0–10, to nearest 0.1 turbidity unit; 10–100, to nearest 1 turbidity unit; >100, to nearest 10 turbidity unit.
Turbidity, backscatter	63682	FBU	
Turbidity, formazin, multibeam	63684	FNMU	
Salinity	00480	ppt	<1, to nearest 0.1 ppt; 1–10, to nearest 0.1 ppt; 10–100, to nearest 1 ppt.
Salinity, calculated from specific conductance at 25 °C	90860	psu	<1, to nearest 0.1 psu; 1–10, to nearest 0.1 psu; 10–100, to nearest 1 psu.

<sup>a</sup>Submersible-type sensors currently (2006) in use for monitoring environmental turbidity typically are reported in FNU. See Anderson (2004) for a description of the method codes that apply to particular instrument manufacturers and turbidity parameter codes for other measurement technologies.

The maximum could be reported as greater than (>) the manufacturer's reporting limit (for example, >1,400 FNU). Reporting as greater than the individual instrument maximum limit, or as >1,700 FNU in this example, is recommended. The maximum sensor response can be determined by carefully holding a wet tissue or towel completely over the optical sensor after calibration and observing the reading.

Salinity should be reported in practical salinity units, a dimensionless unit that uses the PSS (Lewis, 1980). Salinity, reported in practical salinity units, is based on measurements of conductivity, temperature, and pressure and is nearly the same as direct measurements of salinity in parts per thousand.

## Archiving of Records

In accordance with USGS policy, all original data that (1) are published or (2) support published scientific analyses must be archived (Hubbard, 1992; U.S. Geological Survey, 1992). Original data from automated data-collection stations, laboratories, outside sources, and non-automated field observations are unmodified data collected or received

in conventional units (engineering units, generally with a decimal). Original data must be preserved in its original form, regardless of how the data may be modified later (Hubbard, 1992). Recent USGS policy (U.S. Geological Survey, 1999) reaffirms the requirement of preserving original, unaltered field data and further requires that the data be preserved in computer-readable (electronic) digital format. In addition, paper copies of digital field-recorded time-series data are no longer required. All USGS personnel responsible for the collection, analysis, manipulation, and storage of water-quality monitoring data must ensure that the specified requirements of archiving original electronic data are implemented.

In addition to electronic field data, original water-quality monitoring data on paper may include field notes, field measurements, calibration notes, analytical service requests, and water-quality analytical printouts. These data are archived when the project is completed or terminated, or if data are more than 7 years old. It is the responsibility of the Water Science Center Director to ensure that project files are entered into the Water Science Center archive and are organized and complete. The archive should be well documented and maintained by appointed personnel in the Water Science Center.



## Summary

Recording systems that measure physical and chemical water-quality field parameters at discrete time intervals provide a nearly continuous record of water quality. A common configuration is the four-parameter water-quality monitoring system that collects temperature, specific conductance, dissolved oxygen, and pH data, although systems can be configured to measure other properties, such as turbidity or fluorescence. The sensors that are used to measure these water properties require careful field observation, cleaning, and calibration. Producing an accurate final water-quality record requires thorough and consistent procedures for the computation, publication, and archiving of the data.

This report provides guidelines for U.S. Geological Survey personnel in site- and monitor-selection considerations; sensor inspection and calibration methods; field procedures; data evaluation, correction, and computation; and record review and data-reporting processes. Emerging sensor technology broadens the variety of measurable chemical constituents, allows lower detection limits, and provides increased stability and accuracy. Recent improvements make it possible to access near real-time water-quality monitoring data on the Internet. Such technological progress will continue to improve applications and allow quality-control procedures to be refined even further.

## References

- Albert, C.D., 1964, Brine in surface waters of the Little Arkansas River basin, Kansas: Kansas Department of Health Bulletin 1–5, 14 p.
- Alliance for Coastal Technologies, 2004, State of technology in the development and application of dissolved oxygen sensors, Proceedings of the Workshop on Dissolved Oxygen Sensors, Savannah, Georgia, January 12–14, 2004: University of Maryland Technical Report Series No. TS-444-04-CBL, 18 p.; accessed May 27, 2005, at [http://www.act-us.info/download/workshop\\_reports/ACT\\_WR04-01\\_DO\\_Sensors.pdf](http://www.act-us.info/download/workshop_reports/ACT_WR04-01_DO_Sensors.pdf)
- Alt, D.F., and Iseri, K.T., 1986, Water Resources Division publications guide, v. 1, 1986 ed., Publications policy and text preparation: U.S. Geological Survey Open-File Report 87–205, 429 p.; accessed July 7, 2005, at <http://pubs.er.usgs.gov/pubs/ofr/ofr87205>
- American Public Health Association, 1998, 2520 Salinity, in Clesceri, L.S., and others, eds., Standard methods for examination of water and wastewater (20<sup>th</sup> ed.): Washington, DC, American Public Health Association, p. 2–48 – 2–49.
- Anderson, C.W., 2004, Turbidity (version 2.0): U.S. Geological Survey Techniques of Water-Resources Investigations, book 9, chap. A6, section 6.7, 64 p.; accessed October 28, 2004, at <http://pubs.water.usgs.gov/twri9A6/>
- ASTM International, 2003, D1889–00, Standard test method for turbidity of water: ASTM International, Annual Book of Standards, Water and Environmental Technology, v. 11.01, 6 p.
- Bartholoma, S.D., comp., 2005, User's manual for the National Water Information System of the U.S. Geological Survey, Automated data processing system (ADAPS), version 4.5: U.S. Geological Survey Open-File Report 05–1160, 403 p., accessed in December 2005 at [http://wwwnwis.er.usgs.gov/nwisdocs4\\_5/adaps/adaps.book.html](http://wwwnwis.er.usgs.gov/nwisdocs4_5/adaps/adaps.book.html)
- Busenberg, Eurybiades, and Plummer, L.N., 1987, pH measurement of low-conductivity waters: U.S. Geological Survey Water-Resources Investigations Report 87–4060, 22 p.; accessed July 6, 2005, at <http://pubs.er.usgs.gov/pubs/wri/wri874060>
- Christensen, V.G., Jian, X., and Ziegler, A.C., 2000, Regression analysis and real-time water-quality monitoring to estimate constituent concentrations, loads, and yields in the Little Arkansas River, South-Central Kansas, 1995–99: U.S. Geological Survey Water-Resources Investigations Report 00–4126, 36 p.; accessed July 6, 2005, at <http://pubs.water.usgs.gov/wrir004126>
- Clifton, D.G., and Gilliom, R.J., 1989, Sources and concentrations of dissolved solids and selenium in the San Joaquin River and its tributaries, California, October 1985 to March 1987: U.S. Geological Survey Water-Resources Investigations Report 88–4217, 33 p.; accessed July 6, 2005, at <http://pubs.er.usgs.gov/pubs/wri/wri884217>
- Ficken, J.H., and Scott, C.T., 1989, Operating manual for the U.S. Geological Survey minimonitor—Analog-voltage model: U.S. Geological Survey Open-File Report 89–403, 55 p.; accessed in July 2005 at <http://pubs.er.usgs.gov/pubs/ofr/ofr89403>
- Gordon, A.B., and Katzenbach, M.S., 1983, Guidelines for use of water-quality monitors: U.S. Geological Survey Open-File Report 83–681, 94 p.; accessed June 3, 2005, at <http://pubs.er.usgs.gov/pubs/ofr/ofr83681>
- Gray, J.R., and Glysson, G.D., 2003, Proceedings of the federal interagency workshop on turbidity and other sediment surrogates, April 30–May 2, 2002, Reno, Nevada: U.S. Geological Survey Circular 1250, 56 p.; accessed May 27, 2005, at <http://pubs.water.usgs.gov/circ1250/>
- Hem, J.D., 1989, Study and interpretation of the chemical characteristics of natural water: U.S. Geological Survey Water-Supply Paper 2254, 264 p.; accessed July 6, 2005, at <http://pubs.water.usgs.gov/wsp2254/>

- Hill, B.R., and Gilliom, R.J., 1993, Streamflow, dissolved solids, suspended sediment, and trace elements, San Joaquin River, California, June 1985–September 1988: U.S. Geological Survey Water-Resources Investigations Report 93–4085, 21 p.; accessed July 6, 2005, at <http://pubs.er.usgs.gov/pubs/wri/wri934085>
- Hubbard, E.F., comp., 1992, Policy recommendations for management and retention of hydrologic data of the U.S. Geological Survey: U.S. Geological Survey Open-File Report 92–56, 32 p.; accessed July 6, 2005, at <http://pubs.er.usgs.gov/pubs/ofr/ofr9256>
- International Organization for Standardization, 1999, Water quality—Determination of turbidity: Geneva, Switzerland, International Organization for Standardization, ISO 7027, 10 p.
- Lewis, E.L., 1980, The Practical Salinity Scale 1978 and its antecedents: IEEE Journal of Oceanic Engineering, v. OE–5, no. 1, p. 3–8.
- Lewis, M.E., 2005 (revised), Dissolved oxygen: U.S. Geological Survey Techniques of Water-Resources Investigations, book 9, chap. A6, section 6.2, 34 p.; draft accessed October 3, 2005, at <http://pubs.water.usgs.gov/twri9A6/>
- Miller, R.L., Bradford, W.L., and Peters, N.E., 1988, Specific conductance; theoretical considerations and application to analytical quality control: U.S. Geological Survey Water-Supply Paper 2311, 16 p.
- Novak, C.E., 1985, WRD data reports preparation guide: U.S. Geological Survey Open-File Report 85–480, 289 p.; accessed July 6, 2005, at <http://pubs.er.usgs.gov/pubs/ofr/ofr85480>
- Radtke, D.B., Busenberg, Eurybiades, Wilde, F.D., and Kurklin, J.K., eds., 2003, pH (version 1.2): U.S. Geological Survey Techniques of Water-Resources Investigations, book 9, chap. A6, section 6.4, 28 p.; accessed July 28, 2004, at <http://pubs.water.usgs.gov/twri9A6/>
- Radtke, D.B., Davis, J.V., and Wilde, F.D., eds., 2005, Specific electrical conductance (version 1.2): U.S. Geological Survey Techniques of Water-Resources Investigations, book 9, chap. A6, section 6.3, 22 p.; accessed October 3, 2005, at <http://pubs.water.usgs.gov/twri9A6/>
- Radtke, D.B., Kurklin, J.K., and Wilde, F.D., eds., 2004, Temperature (version 1.2): U.S. Geological Survey Techniques of Water-Resources Investigations, book 9, chap. A6, section 6.1, 15 p.; accessed July 28, 2004, at <http://pubs.water.usgs.gov/twri9A6/>
- Rantz, S.E., and others, 1982, Measurement and computation of streamflow—volume 1. Measurement of stage and discharge: U.S. Geological Survey Water-Supply Paper 2175, 284 p.; accessed October 3, 2005, at [http://pubs.usgs.gov/wsp/wsp2175/html/WSP2175\\_vol1.html](http://pubs.usgs.gov/wsp/wsp2175/html/WSP2175_vol1.html)
- Schemel, L.E., 2001, Simplified conversions between specific conductance and salinity units for use with data from monitoring stations—IEP Newsletter, v. 14, no. 1, p. 17–18; accessed July 27, 2004, at <http://www.iep.ca.gov/report/newsletter/2001winter/IEPNewsletterWinter2001.pdf>
- Stanley, D.L., Boozer, T.M., and Schroder, L.J., 1998, Summary of the U.S. Geological Survey National Field Quality-Assurance Program from 1979 through 1997: U.S. Geological Survey Open-File Report 98–392, 11 p.; accessed January 18, 2005, at <http://pubs.water.usgs.gov/ofr98392>
- U.S. Department of the Interior, 1992, Department of the Interior Geological Survey Manual, v. 3, 500.14.1, 3 p.
- U.S. Department of the Interior, 1993, Department of the Interior Geological Survey Manual, v. 3, 500.24.1, 4 p.
- U.S. Environmental Protection Agency, 1993, Methods for the determination of inorganic substances in environmental samples (rev. 2.0): Cincinnati, OH, U.S. Environmental Protection Agency EPA/600/R-93/100, 178 p.
- U.S. Environmental Protection Agency, 1999, Guidance manual for compliance with the Interim Enhanced Surface Water Treatment Rule—Turbidity provisions: Washington, DC, U.S. Environmental Protection Agency, Office of Water, EPA 815–R-99–010, [variously paged].
- U.S. Geological Survey, 1990, Policy for release of digital data: Water Resources Division Memorandum No. 90.30 [deleted]; accessed November 3, 2004, at <http://www.woper.er.usgs.gov/memos/delete/wrd90.030Delete.txt>
- U.S. Geological Survey, 1992, Policy for management and retention of hydrologic data of the U.S. Geological Survey: Water Resources Division Memorandum No. 92.59; accessed July 28, 2004, at <http://water.usgs.gov/admin/memo/policy/wrdpolicy92.059.html>
- U.S. Geological Survey, 1995, Transmittal of an instrumentation plan for the Water Resources Division and the Water Resources Division hydrologic field instrumentation and equipment policy and guidelines: Water Resources Division Memorandum No. 95.35; accessed July 28, 2004, at <http://water.usgs.gov/public/admin/memo/policy/wrdpolicy95.035.html>
- U.S. Geological Survey, 1998, Tables of dissolved oxygen saturation values: Office of Water Quality Memorandum No. 99.01; accessed May 27, 2005, at <http://water.usgs.gov/admin/memo/QW/qw99.01.html>

- U.S. Geological Survey, 1999, Preservation of original digital field-recorded time-series data: U.S. Geological Survey Water Resources Division Memorandum No. 99.33; accessed May 27, 2005, at <http://water.usgs.gov/admin/memo/policy/wrdpolicy99.33.html>
- U.S. Geological Survey, 2000, Quality assurance measures for serving real-time water data on the World Wide Web: U.S. Geological Survey Water-Resources Division Policy Memorandum No. 99.34; accessed May 27, 2005, at <http://water.usgs.gov/admin/memo/policy/wrdpolicy99.34.html>
- U.S. Geological Survey, 2003a, Delegated Director's approval authority for water information products: Office of Water Information Technical Memorandum No. 2003.01; accessed November 9, 2004, at [http://water.usgs.gov/usgs/publishing/Memos/memo2003\\_01.html](http://water.usgs.gov/usgs/publishing/Memos/memo2003_01.html)
- U.S. Geological Survey, 2003b, Guidelines for the release of the Annual State Water Data Reports: Office of Water Information Technical Memorandum No. 2003.02; accessed March 20, 2006, at [http://water.usgs.gov/usgs/publishing/Memos/memo2003\\_02.html](http://water.usgs.gov/usgs/publishing/Memos/memo2003_02.html)
- Webb, W.E., Radtke, D.B., and Iwatsubo, R.T., 1999, Surface-water sampling—Collection methods at flowing-water and still-water sites: U.S. Geological Survey Techniques of Water-Resources Investigations, book 9, chap. A6, section 4.1; accessed July 1, 2005, at <http://pubs.water.usgs.gov/twri9A4/>
- Weiss, R.F., 1970, The solubility of nitrogen, oxygen, and argon in water and seawater: *Deep-Sea Research*, v. 17, no. 4, p. 721–735; accessed July 1, 2005, at <http://water.usgs.gov/owq/rfweiss.paper.pdf>
- White, E.T., comp., 1999, Automated water quality monitoring field manual: British Columbia, Canada, Ministry of the Environment Lands and Parks, Water Management Branch for the Aquatic Inventory Task Force Resources Inventory Committee, version 1.0 [June 8, 1999], 73 p.; accessed July 6, 2005, at [http://www.geoscientific.com/technical/tech\\_references\\_pdf\\_files/BC%20RISC%20Automatic%20Water%20Quality%20Monitoring%20Manual.pdf](http://www.geoscientific.com/technical/tech_references_pdf_files/BC%20RISC%20Automatic%20Water%20Quality%20Monitoring%20Manual.pdf)
- Wilde, F.D., ed., chapter sections variously dated, Field measurements: U.S. Geological Survey Techniques of Water-Resources Investigations, book 9, chap. A6; accessed September 23, 2005, at <http://pubs.water.usgs.gov/twri9A6/>
- Wilde, F.D., and Radtke, D.B., 2005, General information and guidelines: U.S. Geological Survey Techniques of Water-Resources Investigations, book 9, chap. A6, section 6.0, 36 p.; accessed October 3, 2005, at <http://pubs.water.usgs.gov/twri9A6/>



# Attachments

---

1. U.S. Geological Survey continuous water-quality monitor field form.
2. ADAPS primary data tables: (a) example of a standard format ADAPS primary data table, and (b) example of a historical format ADAPS primary data table.
3. Output from Excel spreadsheets for data-correction calculations for temperature, specific conductance, dissolved oxygen, and pH, and a correlation test for sensor linearity.
4. Evaluation and application of a cross-section data correction.
5. Examples of accuracy rating using "Expanded shifts/corrections" output: (a) "Expanded shifts/corrections" daily output, (b) "Expanded shifts/corrections" hourly output for rating transition days, and (c) final rating of accuracy based on "Expanded shifts/corrections" output.
6. Example of a station description for the Yampa River near Maybell, Colorado.
7. Example of a station analysis for specific conductance on the Yampa River near Maybell, Colorado.
8. Calibration criteria, data-correction criteria, maximum allowable limits, and ratings of accuracy.





Attachment 1. USGS continuous water-quality monitor field form.

February 2006

Station No. \_\_\_\_\_



**U.S. GEOLOGICAL SURVEY  
CONTINUOUS WATER-QUALITY MONITOR FIELD FORM**

Station No. \_\_\_\_\_ Station Name \_\_\_\_\_  
 Monitor Inspected By \_\_\_\_\_ Date \_\_\_\_\_ Watch Time \_\_\_\_\_ Time Datum \_\_\_\_\_  
 Gage Ht \_\_\_\_\_ (Rising, Falling, Steady, Peak) Channel Conditions \_\_\_\_\_  
 Monitor Make/Model \_\_\_\_\_ Monitor Serial No. \_\_\_\_\_  
 Field Meter Make/Model \_\_\_\_\_ Field Meter Serial No. \_\_\_\_\_  
 Weather Cold Cool Warm Hot Rain Mist Sleet Snow Humid Dry Cloudy Pt Cloudy Overcast Clear Windy Gusty Breeze Calm  
 Comments:

MONITOR FOULING CHECKS				
Parameter	Before Cleaning		After Cleaning	
	Time _____		Time _____	
	Recorded/ Live Value	Field Meter	Recorded/ Live Value	Field Meter
Temp (°C)				
pH (units)				
DO (mg/L)				
SC (µS/cm)				
Turbidity ( FNU FNMU FBU ) Method code _____				
Other _____				

**CALIBRATION DRIFT CHECKS**

<u>TEMPERATURE</u> Calibration Criteria: ± 1 percent or ± 0.5 °C for liquid-filled thermometers; ± 0.2 °C for thermistors	Calibration Check Time _____	Recalibration Time _____

Comments:

<u>SPECIFIC CONDUCTANCE</u> Calibration Criteria: the greater of 5 µS/cm or 3% of measured value				Calibration Check Time _____			Recalibration Time _____		
STD VALUE	STD LOT NO.	STD TYPE KCl; NaCl	EXP. DATE	STD TEMP	SC READING	Error %	STD TEMP	SC READING	Error %
Cell range =	Reading in air = (should be zero)								

Comments:

Station No. \_\_\_\_\_

<b>DISSOLVED OXYGEN</b>			Calibration Check				Recalibration						
Calibration Criteria: ± 0.3 mg/L			Time _____				Time _____						
TEMP °C	BARO PRES mm Hg	DO TABLE READING mg/L	SALINITY CORR. FACTOR	DO READING	ERROR %	Reading in zero DO sol'n	TEMP °C	BARO PRES mm Hg	DO TABLE READING mg/L	SALINITY CORR. FACTOR	DO READING	ERROR %	Reading in zero DO sol'n
SALINITY:		SALINITY CORRECTION APPLIED? Y N		DO CHARGE:		DO GAIN:		Date Barometer Calibrated:					
COMMENTS:													

<b>pH</b>				Calibration Check			Recalibration				
Calibration Criteria: ± 0.2 pH units				Time _____			Time _____				
pH BUFFER	THEORETICAL pH FROM TABLE	BUFFER LOT NO.	BUFFER EXP DATE	TEMP	pH READING	ERROR %	TEMP	pH READING	ERROR %	SLOPE	MILLI-VOLTS
pH 7											
pH ____											
pH ____											
Comments:											

<b>TURBIDITY</b>			Calibration Check			Recalibration		
Calibration Criteria: ± 0.5 Turbidity Units or ± 5%			Time _____			Time _____		
	Lot no. or Date Prepared	CONC	TEMP °C	READING	ERROR %	TEMP °C	READING	ERROR %
Stock Turbidity Standard								
Zero Standard (DIW)								
Standard 1								
Standard 2								
Standard 3								
Turbidity Sensor Limit :		Comments:						

FINAL READINGS					Time _____	
Parameter	Recorded/Live Value	Field Meter	Parameter	Recorded/Live Value	Field Meter	
Temp (°C)			Turbidity ( FNU FNMU FBU ) METHOD CODE _____			
pH (units)						
DO (mg/L)			Other _____			
SC (µS/cm)						

Station No. \_\_\_\_\_

CROSS-SECTION SURVEY INFORMATION	
Method	EWI EDI Other _____ No. of Verticals _____
Measurement Location:	_____ ft upstream downstream of monitor
Stream Mixing:	Excellent Good Fair Poor
Comments	_____

Station	Time	Ft from left bank (00009) or ft from right bank (72103)	Depth to bottom at meas. loc. ft (81903)	Measurement depth ft (00003)	Temp °C (00010)	pH units (00400)	SC µS/cm (00095)	DO mg/L (00300)	Turbidity ( ) ( )	Other ( ) ( )	NWIS Record No.
Gage ht =											
At monitor											
1											
2											
3											
4											
5											
6											
7											
8											
9											
10											
11											
12											
13											
14											
15											
16											
17											
18											
19											
20											
At monitor											
Gage ht =											

CROSS-SECTION COMPARISON AT _____ CFS			
Parameter	Cross-section median	Point value	Indicated coefficient
Water Temp	°C	°C	
pH	units	units	
SC	µS/cm	µS/cm	
DO	mg/L	mg/L	
Turbidity	_____	_____	
Other _____			





**Attachment 2. ADAPS primary data tables.**

**Attachment 2-a. Example of a standard format ADAPS primary data table.**

U.S. DEPARTMENT OF THE INTERIOR - U.S. GEOLOGICAL SURVEY - WATER RESOURCES

STATION NUMBER 13351000 PALOUSE RIVER AT HOOPER, WA SOURCE AGENCY USGS STATE 53 COUNTY 075  
 LATITUDE 464531 LONGITUDE 1180852 NAD27 DRAINAGE AREA 2500.00 CONTRIBUTING DRAINAGE AREA 2500 DATUM 1040.8 NGVD29

Date Processed: 2004-11-08 11:28 By rjwagner  
 Primary Computations of Specific cond at 25C  
 Specific cond at 25C, in us/cm @ 25C

Time zone: PST DST used

Stored statistics: Maximum, Minimum, Mean, Median

PROVISIONAL DATA FOR WATER YEAR ENDING SEPT. 30, 2002

-----	(00095)	Specific cond at 25Cus/cm @ 25C	-----						
FLAGS	DATE	MAX	CORR	TIME	MIN	CORR	TIME	MEAN	CORR
-----	-----	-----	-----	-----	-----	-----	-----	-----	-----
	09-01-2002	347	-17	0900	336	-16	0100	341	-17
	09-02-2002	346	-18	1100	335	-18	2300	340	-18
	09-03-2002	345	-19	0800	324	-19	2400	338	-19
	09-04-2002	331	-20	0900	308	-19	2300	322	-20
	09-05-2002	331	-21	1100	308	-19	0000	321	-21
	09-06-2002	338	-23	0900	319	-22	0000	330	-23
	09-07-2002	341	-25	0800	331	-24	0000	338	-25
	09-08-2002	343	-27	1000	335	-26	0000	340	-27
	09-09-2002	343	-28	1100	336	-29	2300	340	-28
	09-10-2002	343	-30	0800	336	-29	0000	340	-13

**Attachment 2-b. Example of a historical format ADAPS primary data table.**

U.S. DEPARTMENT OF THE INTERIOR - U.S. GEOLOGICAL SURVEY - WATER RESOURCES  
 STATION NUMBER 13351000 PALOUSE RIVER AT HOOPER, WA SOURCE AGENCY USGS STATE 53 COUNTY 075  
 LATITUDE 464531 LONGITUDE 1180852 NAD27 DRAINAGE AREA 2500.00 CONTRIBUTING DRAINAGE AREA 2500 DATUM 1040.8 NGVD29

Date Processed: 2004-11-08 11:26 By rjwagner  
 Primary Computations of Specific cond at 25C

Specific cond at 25C, in uS/cm @ 25C

Time zone: PST DST used

Stored statistics: Maximum, Minimum, Mean, Median  
 working

PROVISIONAL DATA FOR WATER YEAR ENDING SEPT. 30, 2002

----- (00095) Specific cond at 25CuS/cm @ 25C -----		Value At Indicated Hours												
Flag	Date	Maximum Value	Minimum Value	Mean Value	Maximum Corr.	Minimum Corr.	0000	0100	0200	0300	0400	0500	0600	0700
		<Time>	<Time>	<Time>	<Time>	<Time>								
09-01-2002		347	336	341	-17	-16	337	336	337	338	341	344	345	346
		<0900>	<0100>		<0900>	<0100>	346	347	346	345	344	343	342	342
							340	339	339	339	337	337	338	337
09-02-2002		346	335	340	-18	-18	337	336	336	337	338	340	341	342
		<1100>	<2300>		<1100>	<2300>	344	345	345	346	344	344	344	345
							341	340	339	339	337	338	337	335
09-03-2002		345	324	338	-19	-19	335	336	337	337	338	341	342	343
		<0800>	<2400>		<0800>	<2400>	345	344	344	343	342	341	341	338
							338	336	335	332	331	331	329	327
09-04-2002		331	308	322	-20	-19	324	322	322	322	324	326	327	329
		<0900>	<2300>		<0900>	<2300>	330	331	331	329	325	328	326	323
							321	319	317	316	314	312	310	308
09-05-2002		331	308	321	-21	-19	308	308	309	312	315	319	322	326
		<1100>	<0000>		<1100>	<0000>	327	329	330	331	330	327	323	321
							323	321	321	321	320	318	319	319
09-06-2002		338	319	330	-23	-22	319	320	323	325	328	330	333	335
		<0900>	<0000>		<0900>	<0000>	336	338	338	337	331	333	333	331
							326	329	328	328	328	328	330	330
09-07-2002		341	331	338	-25	-24	331	332	333	336	337	337	338	340
		<0800>	<0000>		<0800>	<0000>	341	341	341	341	339	341	339	339
							338	338	338	336	337	337	337	336
09-08-2002		343	335	340	-27	-26	335	337	337	339	341	341	341	342
		<1000>	<0000>		<1000>	<0000>	342	342	343	343	343	342	342	342
							341	339	340	340	339	338	338	337
09-09-2002		343	336	340	-28	-29	338	338	338	339	339	340	341	342
		<1100>	<2300>		<1100>	<2300>	342	342	342	343	343	337	341	340
							342	340	340	339	338	337	337	336
09-10-2002		343	336	340	-30	-29	336	337	338	338	339	340	341	342
		<0800>	<0000>		<0800>	<0000>	343	343	343	342	342	340	340	340
							339	338	338	338	338	337	337	338

**Attachment 3. Output from Excel spreadsheets for data-correction calculations for temperature, specific conductance, dissolved oxygen, and pH, and a correlation test for sensor linearity.**

VERSION 2.2 04/28/2005

**TEMPERATURE** – Calculations of data corrections for temperature are based on meter-to-meter comparisons of a Water Science Center-certified field thermistor with the continuous monitor. The certified field thermistor should be checked at least every 4 months against an NIST-traceable thermometer. Corrections are arithmetic, but if a large range in environmental values occurs, consideration should be given to making percentage corrections.

**SPECIFIC CONDUCTANCE** – Data corrections for fouling are percentages based on pre-cleaned and cleaned-sensor readings. Data corrections for calibration drift are based on the average deviation from expected readings of the cleaned monitor in three standard solutions.

**DISSOLVED OXYGEN** – Data corrections for fouling are percentages based on pre-cleaned and cleaned-sensor readings. Data corrections for calibration drift are based only on the deviation from 100-percent saturation readings. If environmental values are in a lower range (near zero), consideration should be given to making data corrections based on zero-DO readings. If environmental values are in a higher range (much greater than saturation), consideration should be given to making data corrections based on ancillary information, such as Winkler-DO readings or the field meter.

**pH** – Data corrections for fouling are arithmetic, based on pre-cleaned and cleaned-sensor readings. Data corrections for calibration drift are based on the assumption of linear sensor response and the average deviation from expected readings of the cleaned monitor in three standard solutions. If sensor response is not linear, a three-point data-correction curve (V-shift) should be used.

**CROSS SECTION** – Space is included in these spreadsheets for making cross-section data corrections, but no formulas have been entered. It is recommended that cross-section data corrections not be made but rather locate a better site or possibly just downgrade the quality of record. (See attachment 4 for additional information on cross-section corrections.)

**V-SHIFT TEST** – An Excel correlation test is included to give the users a tool that may help determine sensor linearity. This tool does not always work, however, and should be used with care. This tool can be used to help the user better understand sensor linearity. For example, if the three SC standard solutions in the example read 102, 259, and 503, the average is about + 3% departure from 100% linearity and indicates a much better response than the example. The V-shift test, however, gives an  $R^2$  of 0.0656. By experimenting with the test, it is possible to have a better idea of the kind of sensor response that can be expected in the field.



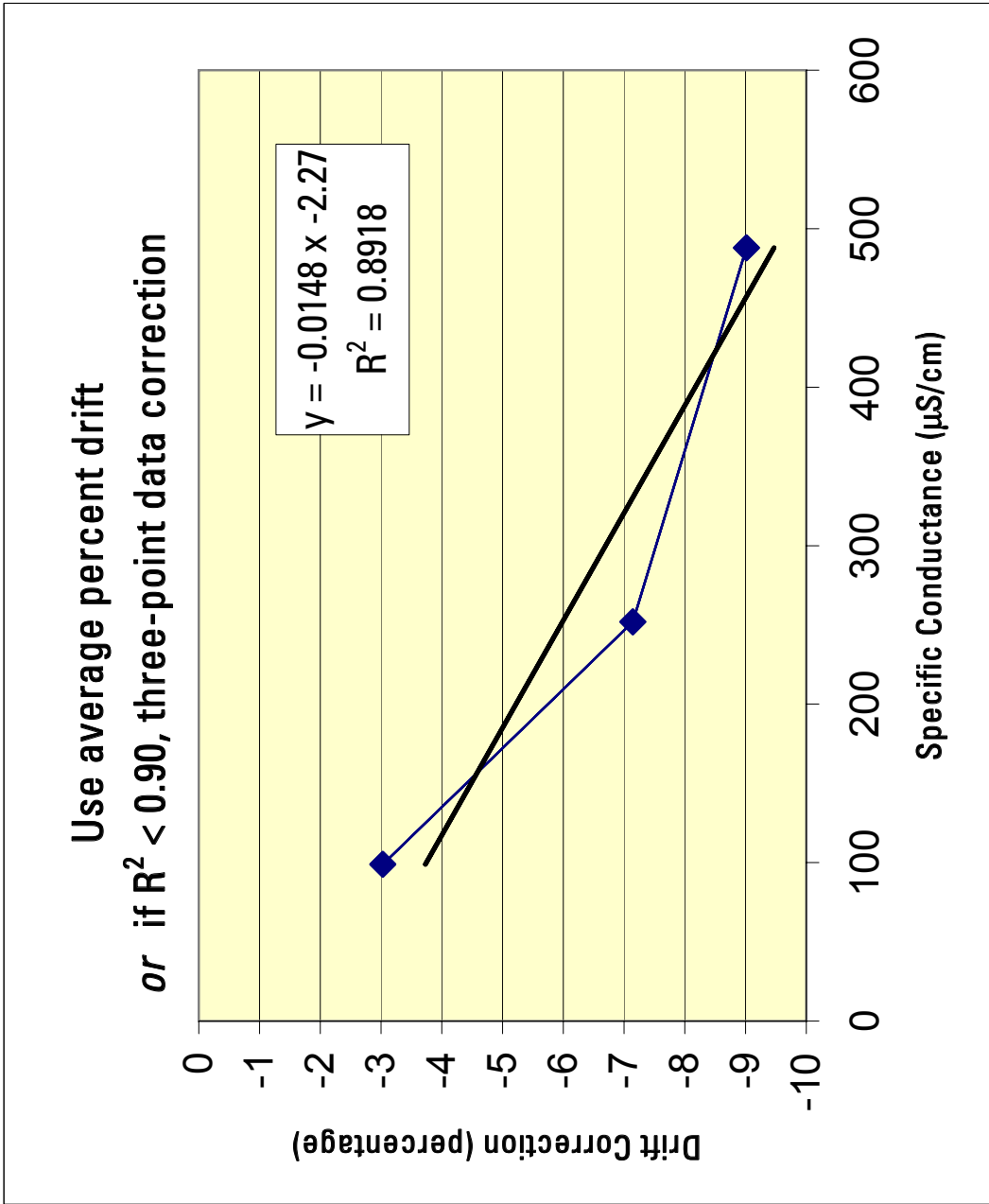








Explanation	Specific conductance	Sensor reading	Sensor drift error (percent)	Average
	99	102	-3.03	
	252	270	-7.14	-6.40
	488	532	-9.02	



#### **Attachment 4. Evaluation and application of a cross-section data correction.**

Recognizing the interdependence of water-quality physical properties under varying flow regimes is essential to the value of a continuous water-quality monitoring program, and understanding these relations is essential in the appropriate application of discharge-dependent corrections. The purpose of cross-section corrections is to adjust the measurements of the monitoring equipment to more accurately reflect conditions in the entire stream cross section, from bank to bank and surface to bottom. The principal value of such adjusted measurements is realized when concurrent discharge measurements permit the computations of constituent loads transported past the station. Primary tables and plots from ADAPS that represent drift and fouling corrections should be made before applying corrections to the cross section. The application of cross-section corrections is intended to improve the accuracy and representativeness of the water-quality measurements; however, cross-section corrections should be made only if the variability in the cross section exceeds the data-correction criteria (table 10) and if sufficient cross-section surveys have been made to accurately define the variability of the physical property. If the relation between recorded values and the measured cross-section values is fairly consistent and predictable, a one- or two-point data correction can be applied to the recorded data. As with fouling and drift corrections, cross-section corrections are based on the cross-section values measured during servicing, and the correction is prorated from the previous servicing. The decision to use a one- or two-point data correction depends on the range of environmental values during the service interval. If the cross-section variability of the measured physical property is fairly consistent and predictable, another option for cross-section corrections is to apply data corrections using an ADAPS rating table (Bartholoma, 2005) of discharge and the measured physical property.

Corrections to the cross section are based on field measurements taken both horizontally and vertically in the stream cross section. Several considerations govern the use of corrections. Cross-section measurements must be made under a variety of flow conditions and all seasonal conditions; once a baseline of cross-section measurements under all seasons and flows has been established, measurements should be made at least twice annually to confirm that the correction applied to the water-quality measurements truly represents the median or mean cross-section values. Corrections should not be applied to water-quality measurements beyond the range of discharge measurements nor during periods of unsteady flow. If the correction for a measured physical property is consistent across a range of discharges and seasons, the correction of the measurement values by simple adjustment is warranted. Seasonal changes in water quality may be representative of the hydrologic system, but they also may be a result of local conditions.





## **Attachment 5. Example of accuracy rating using “Expanded Shifts/Corrections” output.**

The accuracy of the daily record can be calculated in many cases by using the “Expanded shift or corrections” feature (the SHIFT\_TABLE program) in ADAPS, as described by Bartholoma (2005). Accuracy ratings that are measured in concentration or applicable units (water temperature, pH, and perhaps DO or turbidity) can be applied directly by using the expanded shift and corrections for the range of environmental concentrations or values during the period of rating record. Accuracy ratings that are measured in percentages (specific conductance, and perhaps DO or turbidity) can be calculated easily if the data percentages have been applied linearly throughout the range of data, by specifying one or more columns (that are multiples of 10) in the “Table column values selection” of SHIFT\_TABLE (see table 5a). Using a value of 100 in the “Data Corrections Table” produces values that correspond directly to percentages if the value 100 is bracketed by the data corrections during the period of record being rated. For dissolved oxygen records, using the value 10 (if the value 10 is bracketed by the data corrections during the period of record being rated) is easily converted to percentages by moving the decimal point to the right of the number.

Data-quality or project objectives may require precise analysis of accuracy, especially for short-term deployment (several days or weeks) of water-quality monitors. In such cases, accuracy categories may be defined in time increments as small as hours or minutes (see table 5b). In general, however, it is sufficient to rate the accuracy intervals by days for long-term deployment of water-quality monitors. On transition days, usually the day of servicing, the preferred approach of rating is to categorize the entire day as the lowest category that occurred during the day (see table 5c). The maximum correction for the day thus corresponds to the lowest rating of accuracy for the day and should be applied to the daily record.

The current (2006) version of the SHIFT\_TABLE program (NWIS 4.5) combines all data corrections to provide the net correction applied to unit values. Proper application of the accuracy rating requires that the absolute value of net corrections be applied to rate the quality of the unit value records. Thus, if two or more data corrections are used during the same or overlapping time intervals, they both must be positive or negative. If not, the accuracy ratings must be calculated manually. Alternatively, the absolute values of corrections for fouling and drift can be entered into a test (or “dummy”) station to ascertain the ratings of accuracy. If both positive and negative data corrections occur during separate time intervals, the SHIFT\_TABLE program can be used.

**Table 5a. "Expanded Shifts/Corrections" daily output.**

[WA, Washington; USGS, U.S. Geological Survey; NAD27, North American Datum of 1927; NGVD29, National Geodetic Vertical Datum of 1929; Specific cond at 25C, in uS/cm @ 25C, specific conductance in microsiemens per centimeter at 25 degrees Celsius]

STATION NUMBER 13351000 PALOUSE RIVER AT HOOPER, WA SOURCE AGENCY USGS  
 STATE 53 COUNTY 075  
 LATITUDE 464531 LONGITUDE 1180852 NAD27 DRAINAGE AREA 2500.00  
 CONTRIBUTING DRAINAGE AREA 2500 DATUM 1040.8 NGVD29  
 Date Processed: 2004-11-08 11:51 By rjwagner

EXPANDED DATA CORRECTION TABLE

Specific cond at 25C, in uS/cm @ 25C		
DATE/TIME		100
-----		-----
08/19/2002 00:00:00		0.0
08/20/2002 00:00:00		0.0
08/21/2002 00:00:00		-0.2
08/22/2002 00:00:00		-0.6
08/23/2002 00:00:00		-0.9
08/24/2002 00:00:00		-1
08/25/2002 00:00:00		-2
08/26/2002 00:00:00		-2
08/27/2002 00:00:00		-2
08/28/2002 00:00:00		-3
08/29/2002 00:00:00		-3
08/30/2002 00:00:00		-4
08/31/2002 00:00:00		-4
09/01/2002 00:00:00		-4
09/02/2002 00:00:00		-5
09/03/2002 00:00:00		-5
09/04/2002 00:00:00		-6
09/05/2002 00:00:00		-6
09/06/2002 00:00:00		-6
09/07/2002 00:00:00		-7

**Table 5b. “Expanded Shifts/Corrections” hourly output for rating transition days.**

[Transition day, rating of accuracy changes from one category to another. The first example changes from excellent to good]

DATE / TIME	100
-----	-----
08/29/2002 00:00:00	-3
08/29/2002 01:00:00	-3
08/29/2002 02:00:00	-3
08/29/2002 03:00:00	-3
08/29/2002 04:00:00	-3
08/29/2002 05:00:00	-3
08/29/2002 06:00:00	-3
08/29/2002 07:00:00	-3
08/29/2002 08:00:00	-3
08/29/2002 09:00:00	-3
08/29/2002 10:00:00	-3
08/29/2002 11:00:00	-3
08/29/2002 12:00:00	-3
08/29/2002 13:00:00	-3
08/29/2002 14:00:00	-3
08/29/2002 15:00:00	-3
08/29/2002 16:00:00	-3
08/29/2002 17:00:00	-4
08/29/2002 18:00:00	-4
08/29/2002 19:00:00	-4
08/29/2002 20:00:00	-4
08/29/2002 21:00:00	-4
08/29/2002 22:00:00	-4
08/29/2002 23:00:00	-4
08/30/2002 00:00:00	-4
09/06/2002 00:00:00	-6
09/06/2002 01:00:00	-6
09/06/2002 02:00:00	-6
09/06/2002 03:00:00	-6
09/06/2002 04:00:00	-6
09/06/2002 05:00:00	-6
09/06/2002 06:00:00	-6
09/06/2002 07:00:00	-6
09/06/2002 08:00:00	-6
09/06/2002 09:00:00	-6
09/06/2002 10:00:00	-6
09/06/2002 11:00:00	-6
09/06/2002 12:00:00	-6
09/06/2002 13:00:00	-7
09/06/2002 14:00:00	-7
09/06/2002 15:00:00	-7
09/06/2002 16:00:00	-7
09/06/2002 17:00:00	-7

**Table 5c. Final rating of accuracy based on "Expanded Shifts/Corrections" output.**

[Specific cond at 25C, in uS/cm @ 25C, specific conductance in microsiemens per centimeter at 25 degrees Celsius; E, excellent; G, good; F, fair]

EXPANDED DATA-CORRECTION TABLE

Specific cond at 25C, in uS/cm @ 25C

DATE / TIME	100	
-----	-----	
08/19/2002 00:00:00	0.0	E
08/20/2002 00:00:00	0.0	E
08/21/2002 00:00:00	-0.2	E
08/22/2002 00:00:00	-0.6	E
08/23/2002 00:00:00	-0.9	E
08/24/2002 00:00:00	-1	E
08/25/2002 00:00:00	-2	E
08/26/2002 00:00:00	-2	E
08/27/2002 00:00:00	-2	E
08/28/2002 00:00:00	-3	E
08/29/2002 00:00:00	-3	E -> *G
08/30/2002 00:00:00	-4	G
08/31/2002 00:00:00	-4	G
09/01/2002 00:00:00	-4	G
09/02/2002 00:00:00	-5	G
09/03/2002 00:00:00	-5	G
09/04/2002 00:00:00	-6	G
09/05/2002 00:00:00	-6	G
09/06/2002 00:00:00	-6	G -> *F
09/07/2002 00:00:00	-7	F

---

\* Rating was modified based on lowest rating during the day.

**United States Department of the Interior  
GEOLOGICAL SURVEY  
Water Resources Discipline  
Grand Junction, Colorado**

**FIELD STATION DESCRIPTION**

**09251000 Yampa River near Maybell, CO**

**LOCATION.**—Lat 40°30'10", long 108°01'45" (Maybell Quadrangle, CO, scale 1:24,000), in SE 1/4 NW 1/4 sec. 2, T.6 N., R.95 W., Moffat County, Hydrologic Unit 14050002, on left bank 60 ft downstream from bridge on U.S. Highway 40, 2.0 mi downstream from Lay Creek, and 3.0 mi east of Maybell.

**ESTABLISHMENT AND HISTORY.**—Established April 1, 1904 by the State Engineer. Reestablished June 1, 1910 and April 1, 1916. April 17, 1904 to August 18, 1905, vertical staff gage; August 18 to October 31, 1905, June 12, 1910 to November 30, 1911, chain gage; April to November 1912, vertical staff at Thornburgh bridge about 14 mi downstream from the present gage at a different datum. April 24, 1916 to November 3, 1917 chain gage; November 4, 1917 to March 8, 1937, water-stage recorder at Fraker Fork Bridge 700 ft downstream at datum 0.92 ft higher prior to October 1, 1932.

Water-quality Samples—November 1950 to current year.

Continuous water-quality monitoring—November 1950 to August 1973, July 1975 to current year, daily record of specific conductance and water temperature. December 1950 to May 1958, October 1975 to September 1976, October 1977 to September 1978, October 1981 to September 1982, daily record of suspended-sediment discharge. November 1998 to current year, daily record of pH.

**HYDROLOGIC CONDITIONS.**—The Yampa River begins in the Flat Tops and flows north to Steamboat Springs, then flows west to Craig and beyond to its confluence with the Green River. The 3,410-square-mile basin ranges in elevation from over 12,000 ft at the continental divide to 5,900 ft at the gage. The upper part of the drainage is mountainous while the lower part is rolling foothills. Vegetation is very sparse above timberline, moderately to heavily wooded with conifers and aspen from timberline down to about 8,000 ft, lightly to moderately covered with pinon, juniper, and sage from about 8,000 ft down to about 6,500 ft, and lightly covered with sage and grass below 6,500 ft. Stream banks in the drainage are typically lined with willows, brush, and cottonwood trees. Surface geology in the upper part of the basin consists of Tertiary basalts and Cretaceous shales, sandstones, and coal beds. The lower part of the basin consists mostly of Cretaceous shales, sandstones, and coal beds, and Tertiary sandstone and siltstone, with a few Tertiary intrusions scattered throughout the area. There is a small exposure of Paleozoic limestone, sandstone, and shale in Juniper Canyon a few miles upstream of the gage. Major tributaries of the Yampa River include the Elk River, Elkhead Creek, and the Williams Fork River. Sediment yields have been estimated from 0.1 to 0.2 ac-ft/mi<sup>2</sup>/yr in the upper drainage to 0.2 to 0.5 ac-ft/mi<sup>2</sup>/yr in the lower part of the drainage (USGS Open-File Report 83-76). Most streamflow occurs in late spring as a result of snowmelt.

**DRAINAGE AREA.**—3,410 mi<sup>2</sup>, approximate, from U.S. Forest Service maps.

**GAGE.**—A Sutron 8200 data-collection platform (DCP) with satellite telemetry and accubar pressure sensor are housed in a 2x2x3-ft metal shelter mounted on a 21-inch corrugated metal pipe set in concrete, located on left bank 60 ft downstream from new highway bridge. The DCP is set to a wire-weight gage (check bar elevation 23.18 ft) installed on the downstream side of the new highway bridge, near the left bank, on August 18, 1998. The DCP records stage, water temperature, specific conductance, and pH every 30 minutes. The DCP transmits recorded data every four hours. Power is supplied by a 12-volt 26-amp-hour solar-recharged battery.



The datum of the gage is 5900.23 ft above NGVD 1929, from topographic map. Supplemental equipment consists of a three-parameter YSI Model 600XL (2-in. diameter) continuous water-quality monitor which sends water temperature, specific conductance, and pH readings to the DCP. The sonde is located in a 4-in. plastic pipe 60 ft upstream from the gage under the bridge, except during low flows and winter when the sonde is moved into deeper water and weighted to the bottom for protection from ice. A nitrogen tank is stored inside the 21-in. pipe shelter. A National Weather Service weather station is located near the gage shelter with an air-temperature sensor and precipitation gage connected to the Sutron 8200. No sampling equipment is stored in the gage shelter.

Water-quality Instrumentation History—July 1975-1979 or 80?, a Smoot continuous specific conductance and water-temperature monitor; 1980 to September 3 1997, a USGS minimonitor, continuous specific conductance and water temperature; September 3, 1997 to April 9, 1998, a Hydrolab Reporter, continuous specific conductance and water temperature; April 9, 1998 to November 20, 1998, a Hydrolab MiniSonde, continuous specific conductance and water-temperature; November 20, 1998 to present, a YSI 600XL continuous monitor, continuous specific conductance, water temperature, and pH.

#### **REFERENCE AND BENCH MARKS.**—

RM 1 (base) is a standard brass cap set in concrete, located 35 ft shoreward and 20 ft downstream from left bank downstream end of new highway bridge, elevation 16.87 ft.

RM's 2 and 3 were destroyed during bridge construction during fall and winter of 1997–98.

RM 4 is top of 3/4-in. pipe 22 ft shoreward and 7 ft downstream from gage shelter, elevation 17.80 ft.

RM 5 is top of 1/2-in. pin 8 ft streamward and 1 ft downstream from gage shelter, elevation 10.07 ft.

Other elevations—The nut holding the orifice in the orifice pipe cap, elevation  $0.09 \pm 0.05$  ft; check-bar elevation 23.18 ft.

Levels were last run 8/13/2002.

**CHANNEL, CONTROL, AND CROSS-SECTION.**—The channel is straight for about 500 ft upstream and 1,000 ft downstream from the gage. There is one channel at all stages. Streambed is composed of cobbles and boulders. The banks are fairly clean of vegetation. The left bank is steep and will overflow at a stage of about 10.5 ft; the overflow area has moderate grass and sage brush growth. The right bank slopes gradually and is lined with willows at a stage of about 8.0 ft. Behind the willows is a gradually sloping hay field. The control for extreme low flow is cobbles and gravel at the gage (the outside and orifice are in separate pools at these extreme low flows). Control for low and medium stages is a boulder riffle 700 ft downstream from the gage, which is relatively stable but may be altered by high flows or spring ice breakup. High flow control is the channel. During the summer, light to moderate algae growth occurs. Complete ice cover occurs most winters.

Cross-section physical property variability—Variability for all physical properties is rated as well mixed to slightly variable excluding values near the banks in shallow flow. Late summer variability for water temperature (0.5–1.0 °C), dissolved oxygen (1–2 mg/L), and pH (0.2–0.4 units) can be significant in low-flow sections. Specific conductance variability is higher during early spring (when Lay Creek is running) and late summer during extreme low flow (<30 ft<sup>3</sup>/s).

**DISCHARGE MEASUREMENTS.**—Low-flow measurements are made by wading 150 ft below the gage (most uniform cross section) or 60 ft upstream at the monitor. A wading measurement of 894 ft<sup>3</sup>/s (3.03 ft gage height) was made on July 14, 1999 by J.B. Foster, 150 ft below the gage, with minor difficulty. Footing is generally good but cobbles may be slippery when algae is present. Medium and high flows are measured from the downstream side of the bridge 60 ft upstream from the gage. The bridge is marked in 5-ft increments (double marks at 10-ft intervals and triple marks at 100-ft intervals) with the initial point (0) at the right-bank end of the bridge and 296 ft at the left-bank end of the bridge. A bridge crane is recommended. A 50-lb weight is sufficient for all but the highest flows. At the bridge section, most of the flow is in the left center part of the channel, velocities exceed 6.0 ft/s, and depths may exceed 7.0 ft during high flow. Velocities are uniform except for the minor effect of bridge piers. Ice measurements are made at the wading section. **Caution should be used when the**

**river is completely covered with ice, and during spring breakup.** Ice may be thin and the river may be deep due to backwater, even when discharge is low. Measurement accuracy usually is good for all open-water measurements.

**MONITOR EXTREMES.**—

Specific Conductance:

Maximum: 1,630 microsiemens, July 21, 2002.  
Minimum: 78 microsiemens, June 1-2, 1994.

Water temperature:

Maximum: 33.0 °C, Aug. 29, 1976.  
Minimum: 0.0 °C, frequently during winter months.

pH:

Maximum: 9.2, July 19, 2003.  
Minimum: 7.6, August 8, 2001, June 1, 2002.

**SAMPLING METHODS AND EQUIPMENT.**—Procedures used for the collection and processing of water-quality and biological samples are described in USGS Techniques of Water-Resources Investigations Book 9 National Field Manual (NFM) for the Collection of Water-Quality Data and in the Quality-Assurance Plan (QA Plan) for Water-Quality Activities in the USGS Colorado Water Science Center (January 2003). Any deviations from the NFM or the QA Plan are described in the station analysis.

Samples are collected using the equal-width increment (EWI) method when the depths and velocities are sufficient to collect an isokinetic sample. Sampler types are the DH-81 and DH-95 TM or D-95 TM with either a 1/4- or 5/16-in. Teflon nozzle and a plastic cap and bottle. Single- or multiple-vertical samples are collected using an open 3-L plastic bottle when the minimum conditions for isokinetic samples are not met. Single vertical samples should be collected out in a main-flow section and the collection point documented.

EWI samples are composited and processed in a plastic churn splitter; whole-water samples are drawn off through the spigot and dissolved samples are filtered through a 0.45-micron Gelman capsule filter.

Specific conductance (SC) and pH meters are calibrated at least once daily. If a temperature change of >3 °C or greater occurs between sites, the meters are recalibrated. Samples for the determination of SC and pH are drawn off through the spigot of the churn prior to the filtering of the water sample. Dissolved-oxygen meters are calibrated at each site. Typically, the thermistor of the SC meter or a calibration-checked VWR alcohol thermometer are used for the determination of water temperature. Dissolved oxygen and water temperature are measured in-situ. Measurements are made at the centroid of flow. When well-mixed conditions occur, measurements are made in a flowing section near the bank. All field meters and field-meter thermistors are calibrated and checked in accordance with the NFM and QA Plan.

Discharge is measured at the site prior to, during, or after the collection of water samples using standard methods as described in USGS Water-Supply Paper 2175, volume 1 (Rantz and others, 1982). The discharge also can be obtained using the current rating with the most recent shift applied. These computed discharges are finalized at the end of the water year after the surface-water record has been worked and checked.

**FLOODS.**—No data on floods outside the period of record. Maximum discharge observed for the period of record, 25,100 ft<sup>3</sup>/s, May 17, 1984, gage height 12.42 ft.

**POINT OF ZERO FLOW.**—0.49 ± 0.2 ft, September 9, 1999, measured with wading rod.

**WINTER FLOW.**—Complete ice cover during most winters.

**REGULATION AND DIVERSION.**—Natural flow of the stream is affected by transbasin diversions, numerous storage reservoirs, and diversions upstream from the station for irrigation of about 65,000 acres upstream and about 800 acres downstream from the station.

**ACCURACY.**—Discharge records usually are good except for periods of estimated record, which are poor. Continuous water-quality record accuracy is reported yearly in the station analysis. Most data are rated good to excellent.

**COOPERATION AND PURPOSE.**—USGS-Upper Colorado River Compact Station, long-term streamflow data. U.S. Bureau of Reclamation monitors salinity trends by periodic water-quality sampling. Colorado River Water Conservation District, continuous real-time monitoring of water temperature, specific conductance, and pH. The specific conductance record is used to monitor salinity trends. The U.S. Fish and Wildlife Service uses the water temperature and pH record as part of endangered fish recovery studies.

#### ROAD LOG (in miles)

From Craig, CO:

0.0	From intersection of U.S. Highway 40 and Colorado Highway 13 in west end of Craig. Drive west on U.S. 40.
26.1	Cross bridge over Yampa River. Gage is on the left bank 60 ft downstream from the bridge.

From Maybell, CO:

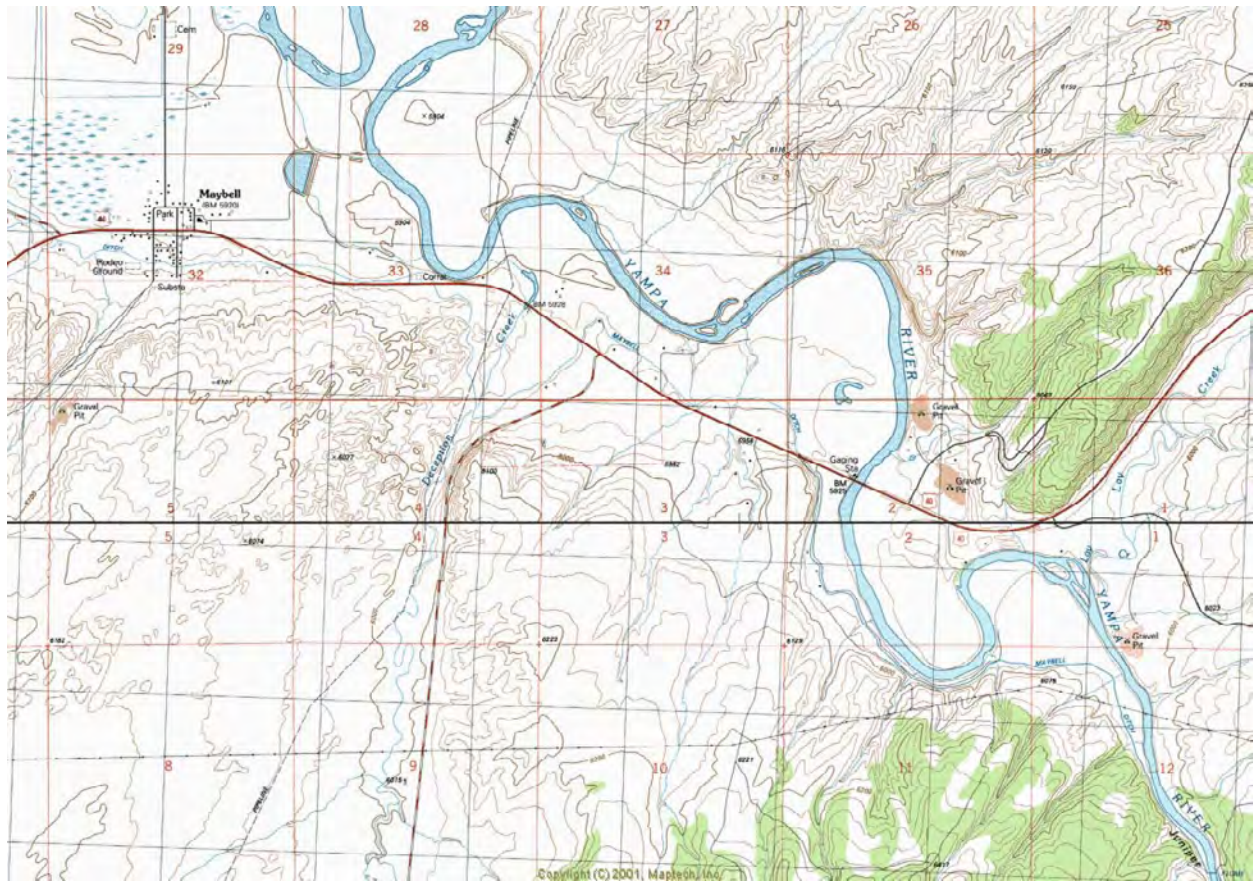
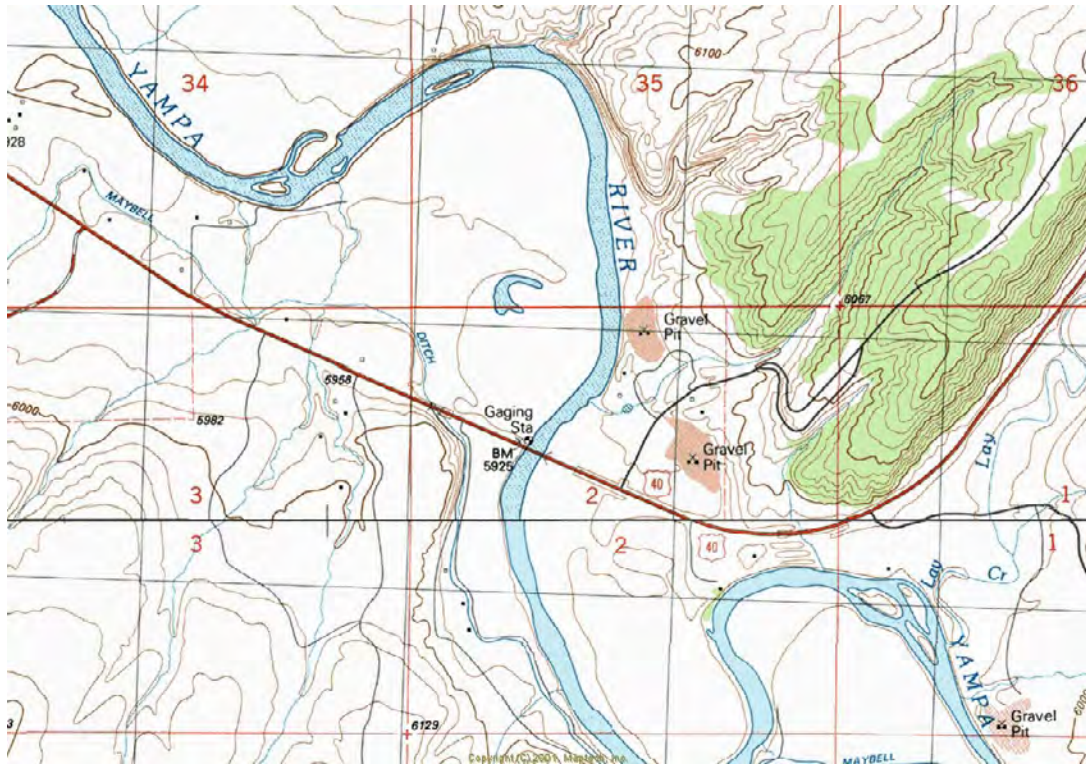
0.0	From U.S. Highway 40 in Maybell, drive east.
3.0	Gage is on the left bank downstream from the bridge.

From Meeker, CO:

**Note! This road may be impassable after heavy snow.**

0.0	Intersection of Colorado Highways 13 and 64 two miles south of Meeker. Take Highway 64 west.
1.1	
1.1	Intersection of Colorado Highway 64 and Rio Blanco County Road 7. Take County Road 7 north.
15.7	
16.8	Moffat County line. Pavement ends. Rio Blanco County Road 7 becomes Moffat County Road 57.
11.8	
28.6	Pavement begins again.
11.4	
40.0	Intersection of Moffat County Road 57 and U.S. Highway 40. Turn right (east) on Highway 40.
1.2	
41.2	Bridge over Yampa River. Gage is on left bank below bridge.





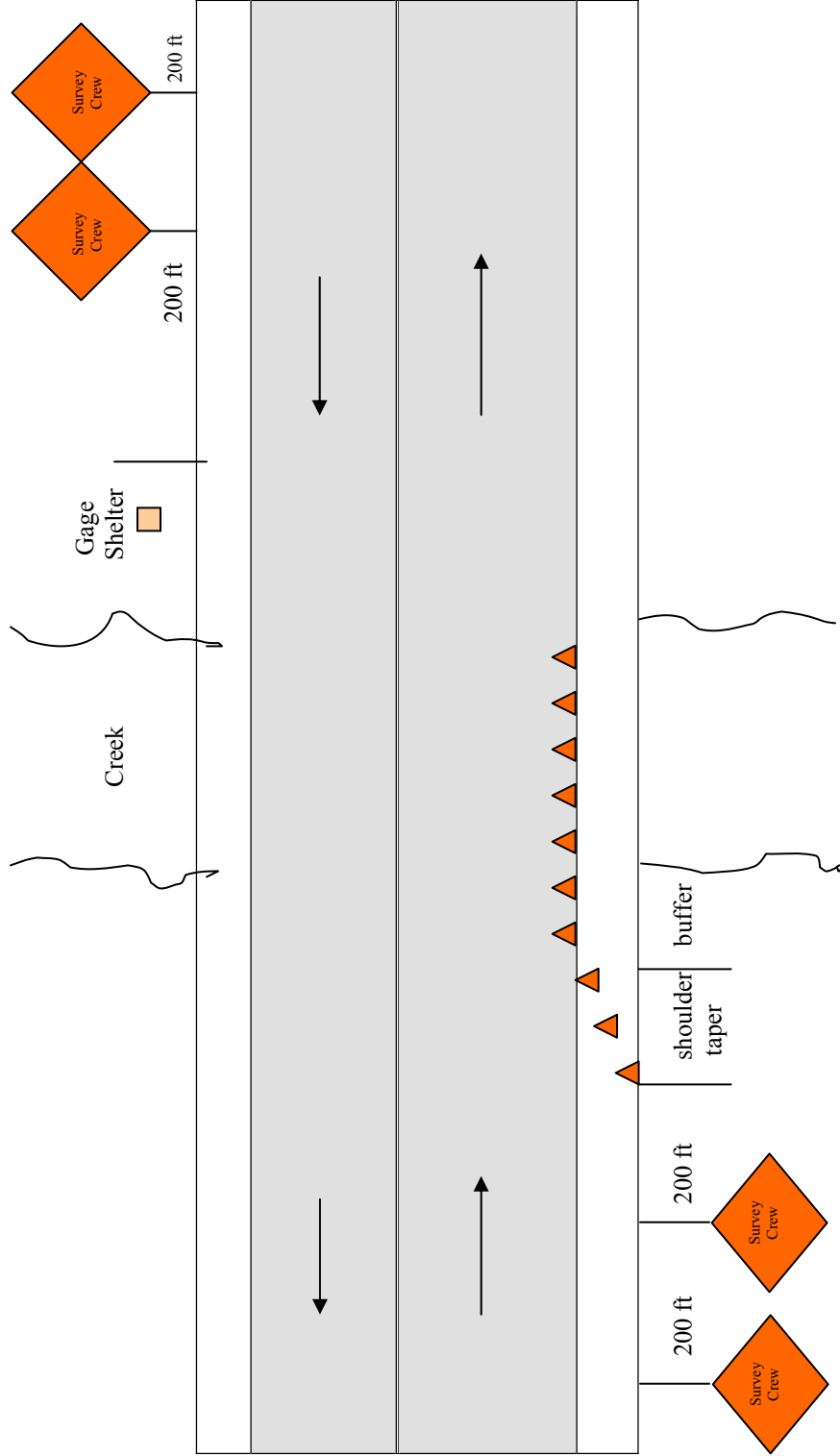
## JOB HAZARD ANALYSIS

<b>Station:</b> 09251000 Yampa River near Maybell, Colorado		<b>Date:</b> December 1, 2002
<b>Prepared by:</b> J.R. Dungan	<b>Approval by 1<sup>st</sup> line supervisor:</b> RW Boulger, Data Chief, signed copy on file	<b>Reviewed by 2<sup>nd</sup> line supervisor:</b>
<b>Policy exemptions at this site:</b> Use of a Personal Floatation Device (PFD) is exempted at this site when flow conditions permit the use of a pygmy meter. Use of the exemption must conform to conditions discussed in District Memorandum, <i>PFD Exemption Memorandum</i> dated January 22, 2002. If you have not read the memorandum or have not had in-water training you must wear a PFD.		
<b>Recommended Protective Clothing and Equipment:</b> PFD, foul weather gear, cell phone, waders, wasp spray, winter cold weather gear, ice cramp-ons, multiple traffic cones, men working sign, ice bar, change of clothes, disinfectant supplies for Hanta-virus.		
JOB/Job Steps	Potential hazards	Recommended Safe Job Practices
<p><u>TRAVEL TO SITE</u> Roads are both paved and dirt /gravel.</p> <p><u>GAGE INSPECTION</u> Check flows (DCP) prior to leaving on field trip.</p> <p><u>WADING MEASUREMENTS</u> Maximum wade is 1,510 cfs, ght 3.56; expect depths of 2.8 feet and velocities of 3.2 feet per second. Ice measurements are required in the winter.</p> <p><u>BRIDGE MEASUREMENTS</u> Bridge has significant traffic.</p>	<p>Poor driving conditions during winter due to ice/snow. Getting stuck, rolling your vehicle or running off the road. Getting lost.</p> <p>Rattlesnakes, drowning, insect bites and stings, encounters with cattle. Falls down steep bank.</p> <p>Drowning, ankle or knee sprains, falling. Slippery cobbles on stream bed. Breaking through thin ice; getting hit by chunks of ice during spring ice break up; hypothermia; falling on ice. Afternoon thunder storms in the summer.</p> <p>Getting struck by a vehicle or flying debris from the roadway. Falling over the bridge rail and drowning. Being struck by the bridge crane. Getting large debris caught on suspension cable.</p>	<p>Observe rules of the road, drive defensibly and according to road conditions.</p> <p>Be observant for animals and snakes. Open gage with caution. Inspect the inside of the shelter for wasps or spiders and check for presence of rodent feces. Be aware of livestock in area. If wasps or spiders are present, use a long distance insect spray. If the presence of rodent feces is detected, follow the cleanup procedures as outlined in the USGS-WRD Hanta Virus Infection Prevention Plan. Be careful traversing steep bank.</p> <p>Know your wading limits. Typically a person can wade up to a factor of 9; 3 foot depths times 3 feet per second velocity. Consider the footing on the streambed. Continually test stream footing and probe the bottom with a wading rod. Use an ice bar to test ice conditions. Continually check for floating ice chunks when ice is breaking up. Do not enter the stream during an electrical storm.</p> <p>Traffic control devices/signs are necessary. Wear highly visible reflective vests. Do not lean over bridge rail. Use sufficient counter weight for the bridge crane. The suspension reel must be equipped with a breakaway cable.</p>

**TRAFFIC PLAN FOR:**

Nature of work: 2-3 times per year, high-flow discharge measurements by USGS personnel from south (downstream) shoulder of bridge. Shoulder will be closed approximately 1.5 hours during measurements.

Conditions: Low volume, low speed. Lanes 10 ft wide, shoulders 2.5 ft wide.







**Attachment 7. Example of a station analysis for specific conductance on the Yampa River near Maybell, Colorado.**

WATER-QUALITY MONITOR STATION ANALYSIS

2002 WATER YEAR

SPECIFIC CONDUCTANCE

09251000

Yampa River near Maybell, CO

**EQUIPMENT.**—Refer to the “Gage” paragraph in the station description for instrument information and sensor location. No equipment were changed or replaced during the period covered by this analysis.

**SITE CHARACTERISTICS.**—The streambed is composed of large cobbles and small boulders. Moderate algal blooms occur during summer months that may affect sensor fouling. At extreme low flows the sensor pool may become isolated from the main flow. Early lowland snowmelt runoff from tributaries affects stream mixing along right bank, shallow sections. Ground water seeps at the left bank also may affect mixing but only within 1 ft of the bank. During low flows in the summer, sections near the right bank are shallow; solar warming and photosynthesis may significantly affect water temperature, dissolved oxygen, and pH. Suspended sediment concentration during snowmelt runoff period generally is low and does not usually foul the sensor significantly.

**RECORD.**—The record is the satellite telemetry data that are processed using DECODES software. Data are logged at a 30-minute interval. The record is complete for the year except as noted. The sonde was removed for a short period in March–April to avoid ice damage. Based on criteria in Water-Resources Investigations Report, 00–4252, table 9, page 23, this record is rated excellent ( $\leq 3\%$  error) except for periods when flow is less than 30 ft<sup>3</sup>/s, July 6–9, 11, 19, 20, 22–27; August 1–9, 13–16, 22; September 11–15, which are rated poor.

Unit values were deleted:

During instrument servicing;

The first part of November, problem unknown;

The first part of December, the sensor was ice-affected;

Periods in July, August, and September when the flow was 7 ft<sup>3</sup>/s or less. At a flow of 3.6 ft<sup>3</sup>/s, the sonde pool was observed to be isolated from the main flow. See the unit value plots for discharge and specific conductance.

Daily values for partial days caused by transmission errors, servicing the sonde, ice-affected values, or isolated flow were updated where data existed during the expected time for the occurrence of the maximum or minimum, if at least 12 hours of values were available for the day, and if values were present adjacent to the extreme for the day.

312 days of record out of 365 days (85%) will be published.

**CALIBRATIONS.**—Calibration checks were conducted six times from October 2001 through October 2002.

Standard solutions from the USGS Water-Quality Supply Unit at Ocala, Florida, were used. All standards that were used bracketed the recorded values.

The largest error in any standard-solution calibration was less than 4%. This error was observed in a low standard and had no effect on the recorded values that were significantly higher for the data period. The mean error for 18 standards was 1.1%. The instrument was recalibrated once in October 2002 to maintain calibration error at a minimum.

**CROSS-SECTION DATA.**—The August cross-section variation was significant. Specific conductance ranged from 1,246 to 1,430  $\mu\text{S}/\text{cm}$ . This survey was conducted at an extreme low flow of 3.6  $\text{ft}^3/\text{s}$ . Poor communication between the sonde pool and the active stream was noted.

**COMPUTATIONS.**—The National Water Information System (NWIS), Automated Data Processing System (ADAPS) version 4.2 was used to compute the record. Calibration checks and field meter readings were used to verify the logged record. Field meter and “live” value comparisons indicate that the recorded values are within 2.5% of the field-measured values. The field meter readings were not used in computation of any portion of the record; they were for general comparison only. The largest fouling error was a minus 2.3%. There was no consistent trend in fouling or calibration errors. Errors for fouling and calibration drift with the same arithmetic sign were less than 3%. No individual fouling or calibration drift error was greater than 3%. No corrections were applied to the record. The greatest uncertainty of the record occurred when the sonde pool became isolated. It is estimated that it occurred when flow was less than 7  $\text{ft}^3/\text{s}$ .

**RECOMMENDATIONS.**—Photos were taken but additional photos are needed to document conditions upstream from the sonde location.

**REMARKS.**— It is uncertain at what flow the sonde pool lost communication with the main flow. It is estimated that when flows approached 30  $\text{ft}^3/\text{s}$  the communication was sufficient. Record at or above this flow is considered excellent.

A new maximum for the period of record was established. It occurred on July 21 at a peak of 60  $\text{ft}^3/\text{s}$ . Data for other periods when the flow was about the same look reasonable; the sonde pool appears to be representative (see July 1–3 and 29–31). Values of conductance can be high at this site during the first flush of an event.

J.R. Dungan collected field data. Cross-section survey results can be retrieved from NWIS, Database 02. The Excel “Field Measurement Summary” spreadsheet for this site and water year summarizes the number of site visits, calibration results, and calculations of the magnitude of fouling and calibration drift and are available electronically in the Subdistrict–Western Slope data directory, [work/gj5work/ws\\_pub/qw.monitors](http://work/gj5work/ws_pub/qw.monitors).

Computed: R.W. Boulger, March 19, 2003

Checked: J. R. Dungan, March 22, 2003

Reviewed: T.A. Solberg, March 26, 2003

**Attachment 8. Calibration criteria, data-correction criteria, maximum allowable limits, and ratings of accuracy.**

[°C, degrees Celsius; ±, plus or minus; ≤, less than or equal to value shown; >, greater than; %, percent; μS/cm, microsiemens per centimeter at 25 degrees Celsius; mg/L, milligram per liter; pH unit, standard pH unit]

Ratings of accuracy (based on combined fouling and drift corrections applied to record)							
Measurement	Calibration criteria	Data-correction criteria	Maximum allowable limits	Excellent	Good	Fair	Poor
Temperature, in °C	±0.2	±0.2	±2.0	≤±0.2	>±0.2–0.5	>±0.5–0.8	>±0.8
Specific conductance, in μS/cm	±5 or ±3% of the measured value, whichever is greater	±5 or ±3% of the measured value, whichever is greater	±30%	≤±3%	>±3–10%	>±10–15%	>±15%
Dissolved oxygen, in mg/L	±0.3	±0.3	±2.0 or 20%, whichever is greater	≤±0.3 or ≤±5%, whichever is greater	>±0.3–0.5 or >±5–10%, whichever is greater	>±0.5–0.8 or >±10–15%, whichever is greater	>±0.8 or >±15%, whichever is greater
pH, in pH unit	±0.2	±0.2	±2	≤±0.2	>±0.2–0.5	>±0.5–0.8	>±0.8
Turbidity, in turbidity units	±0.5 or ±5% of the measured value, whichever is greater	±0.5 or ±5% of the measured value, whichever is greater	±3.0 or ±30%, whichever is greater	≤±0.5 or ≤±5%, whichever is greater	>±0.5–1.0 or >±5–10%, whichever is greater	>±1.0–1.5 or >±10–15%, whichever is greater	>±1.5 or >±15%, whichever is greater



**Prepared by:**

U.S. Geological Survey  
Enterprise Publishing Network  
North Carolina Water Science Center  
3916 Sunset Ridge Road  
Raleigh, NC 27607



