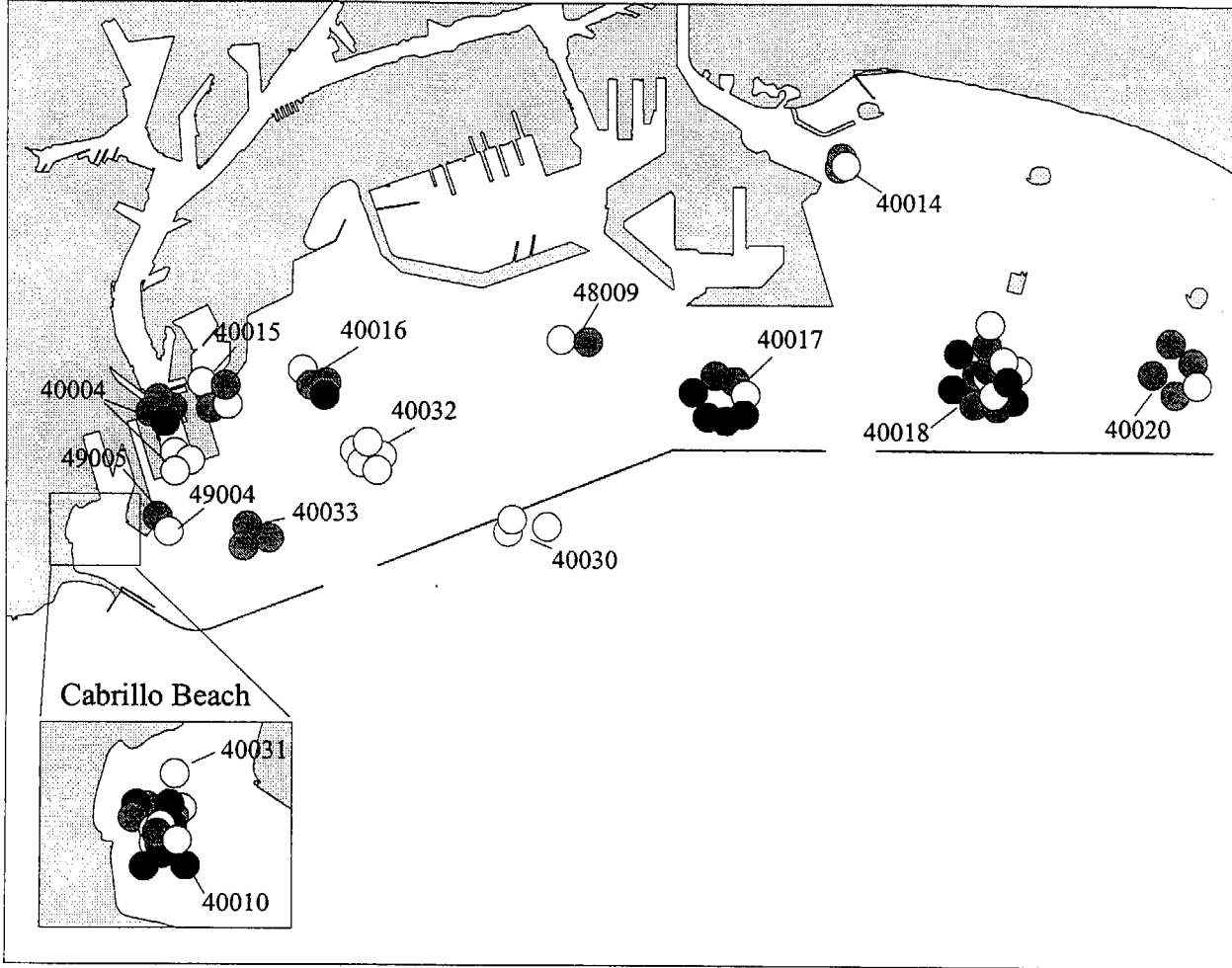
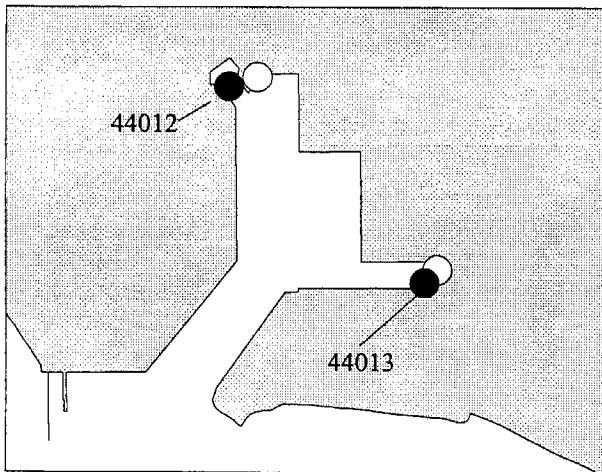


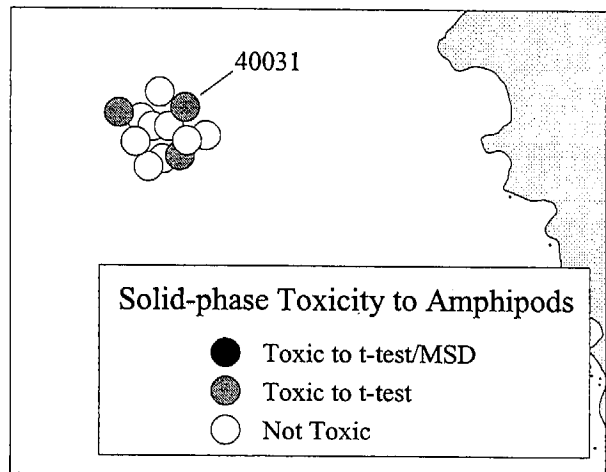
Outer Los Angeles/Long Beach Harbor Stations



Port Hueneme

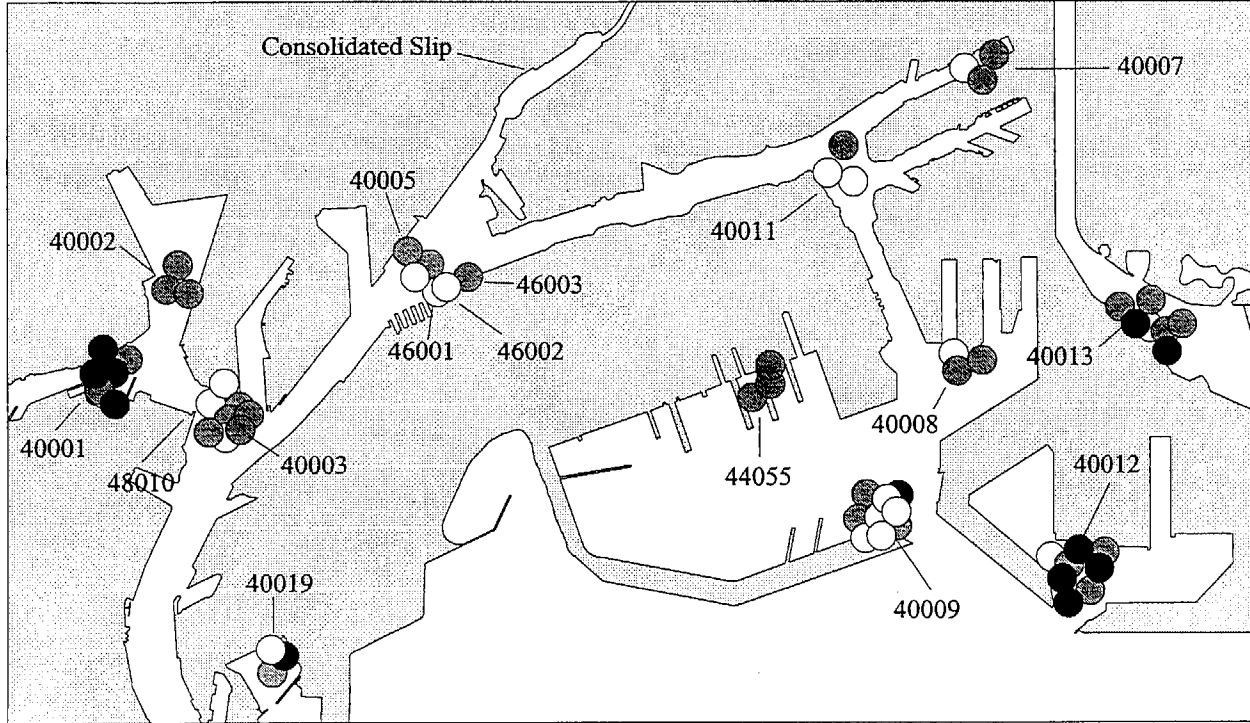


Palos Verdes

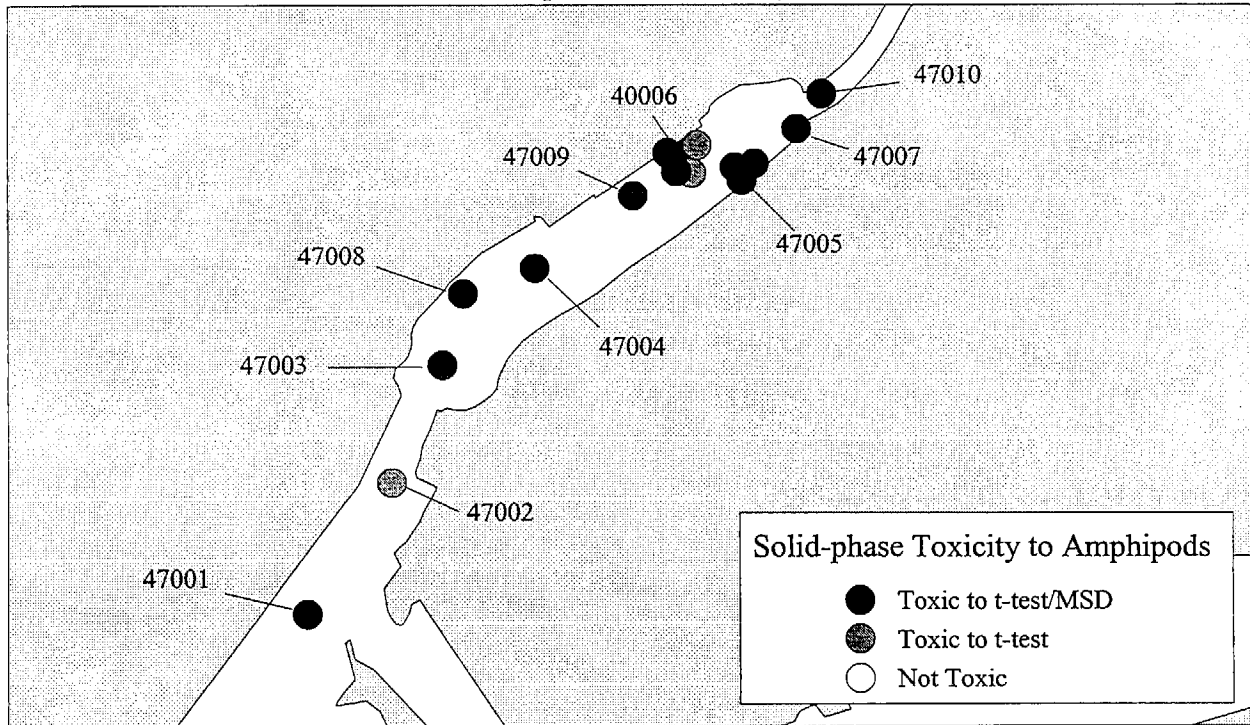


Figures 21a, 21b, and 21c. Toxicity of Sediment Samples in Outer Los Angeles and Long Beach Harbor (a), Port Hueneme (b), and Palos Verdes (c).

Inner Los Angeles/Long Beach Harbor Stations

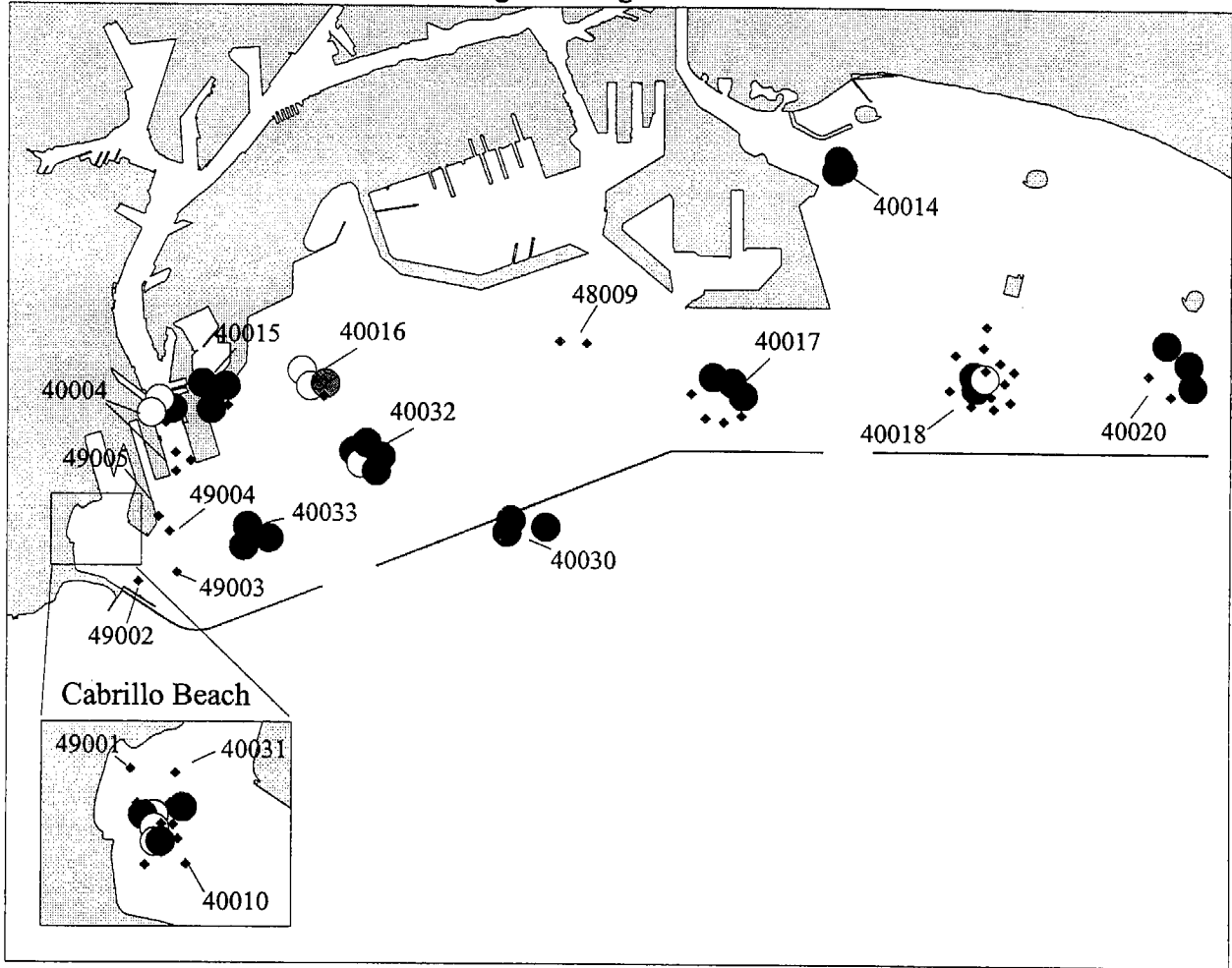


Consolidated Slip of Inner Los Angeles Harbor

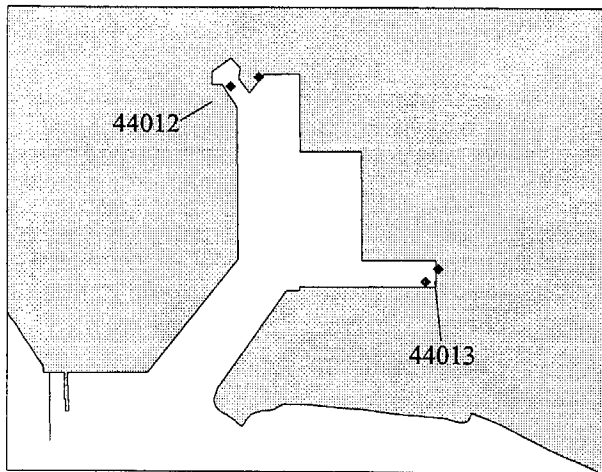


Figures 22a and 22b. Toxicity of Sediment Samples in Inner Los Angeles and Long Beach Harbor (a), and Consolidated Slip (b).

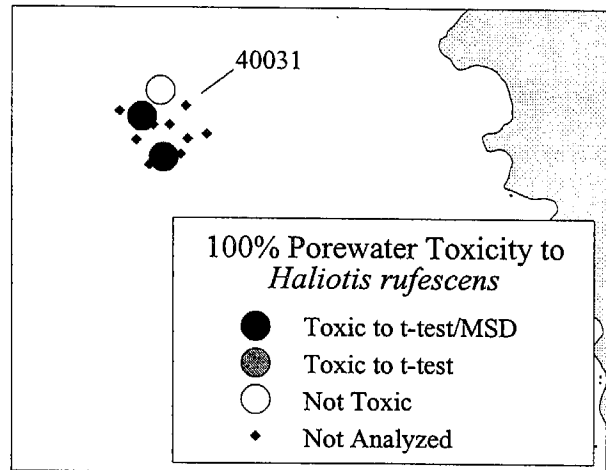
Outer Los Angeles/Long Beach Harbor Stations



Port Hueneme

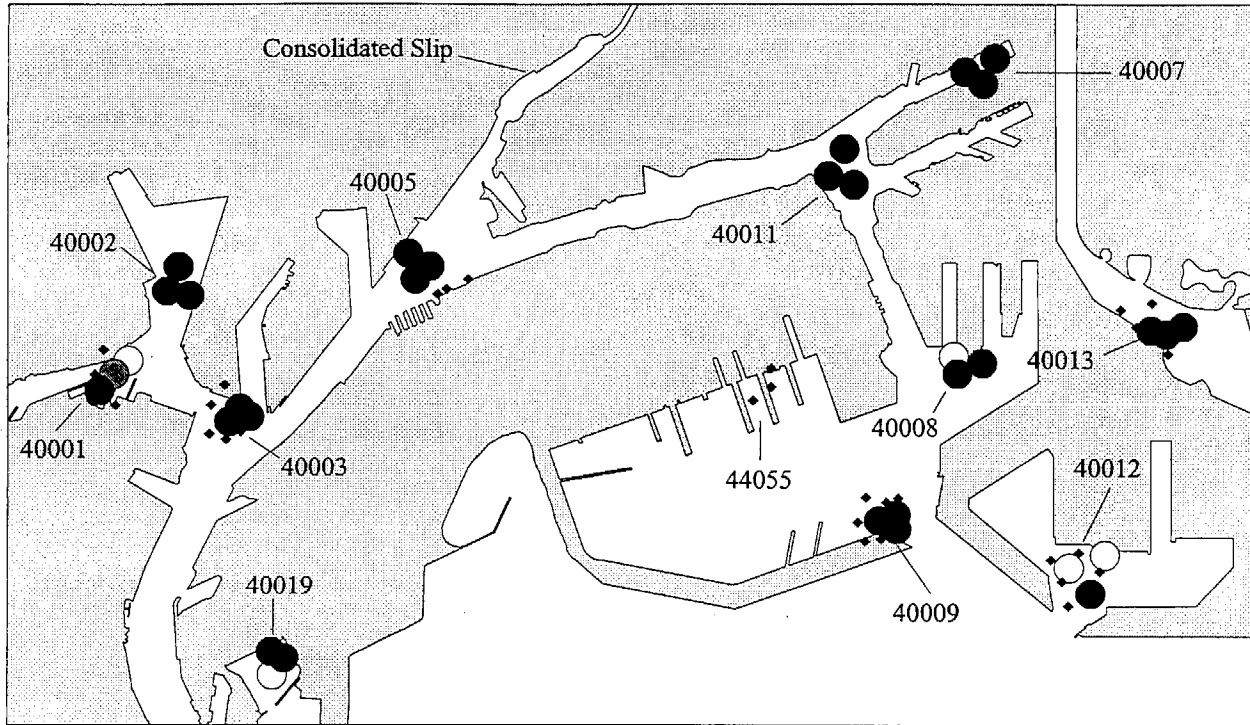


Palos Verdes

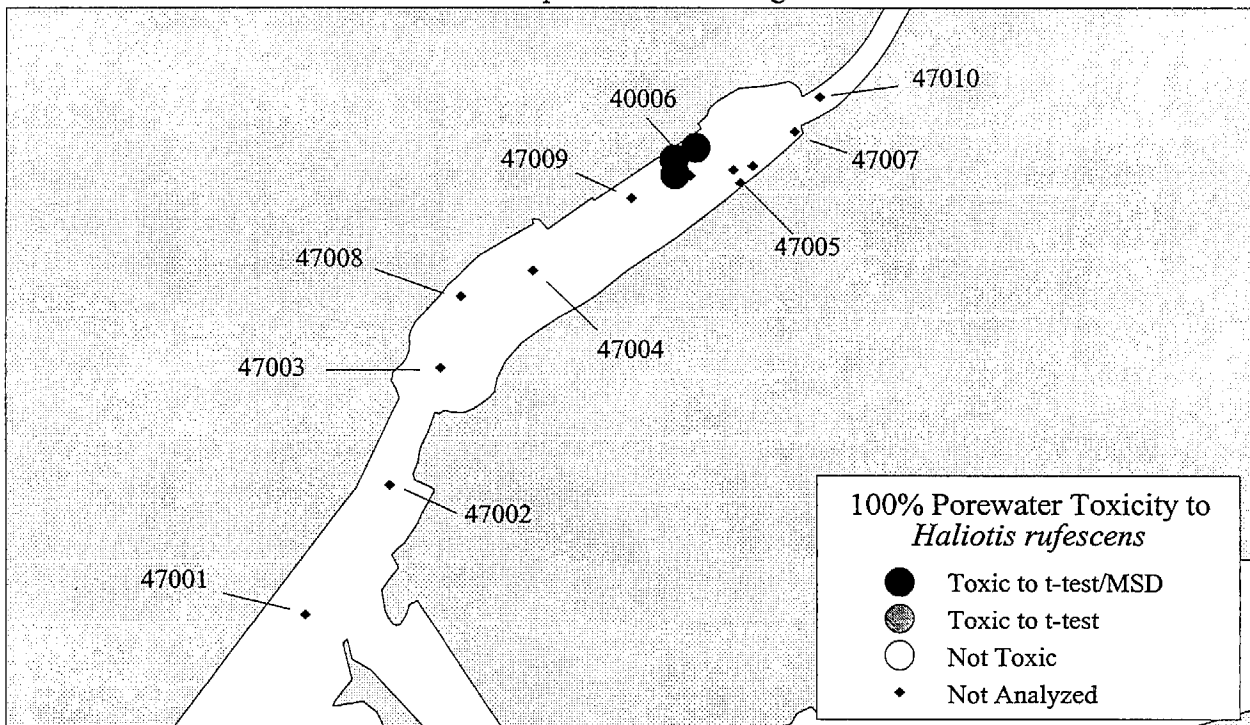


Figures 23a, 23b, and 23c. Toxicity of Porewater Samples in Outer Los Angeles and Long Beach Harbor (a), Port Hueneme (b), and Palos Verdes (c).

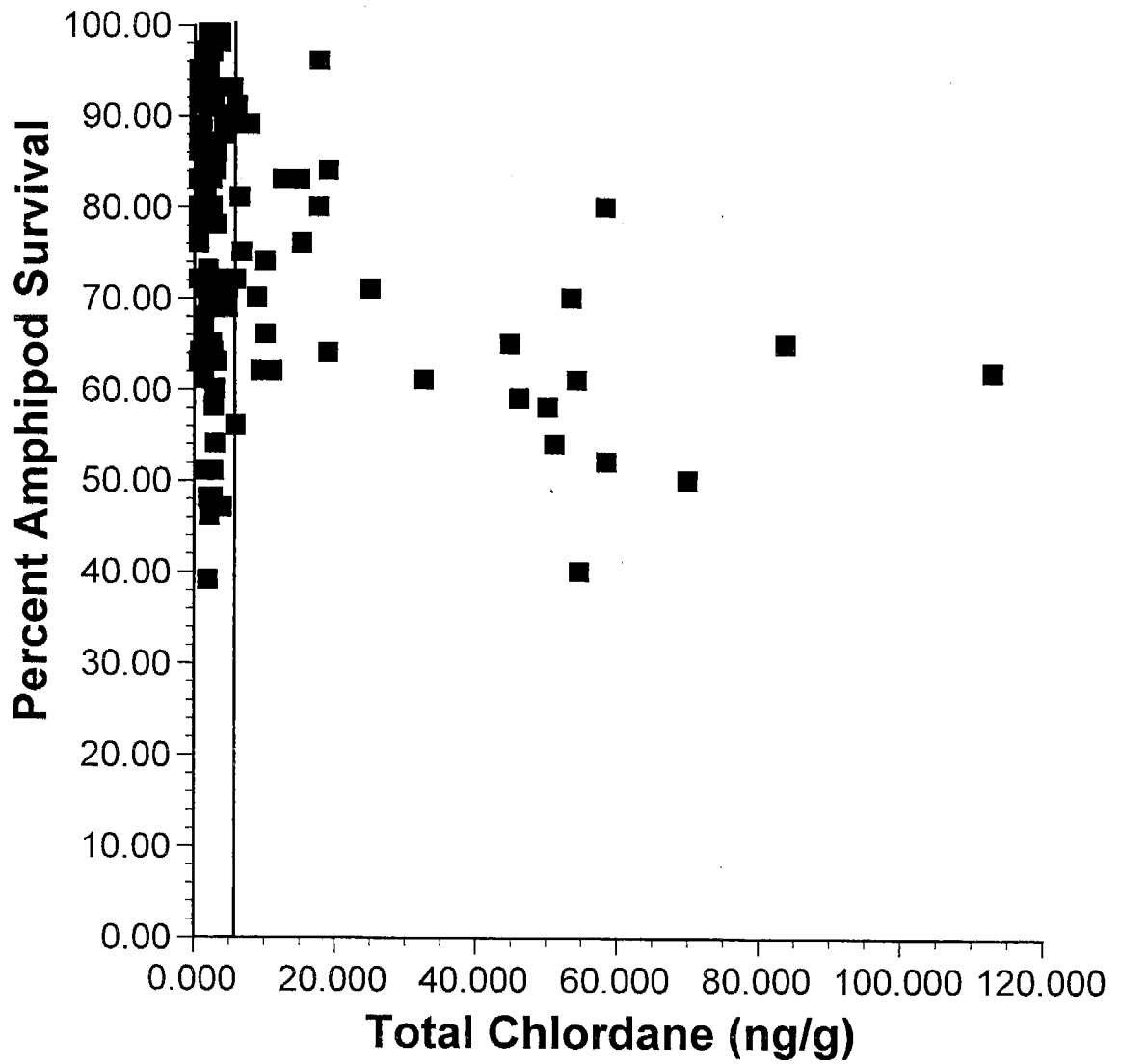
Inner Los Angeles/Long Beach Harbor Stations



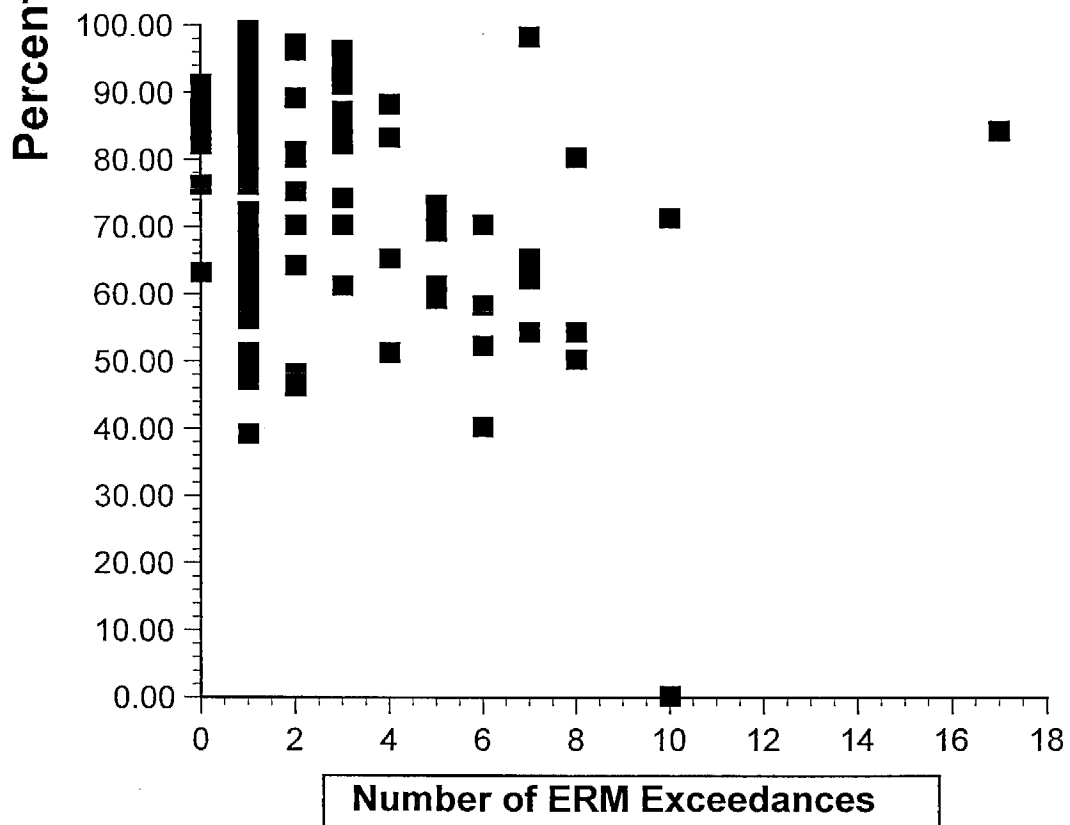
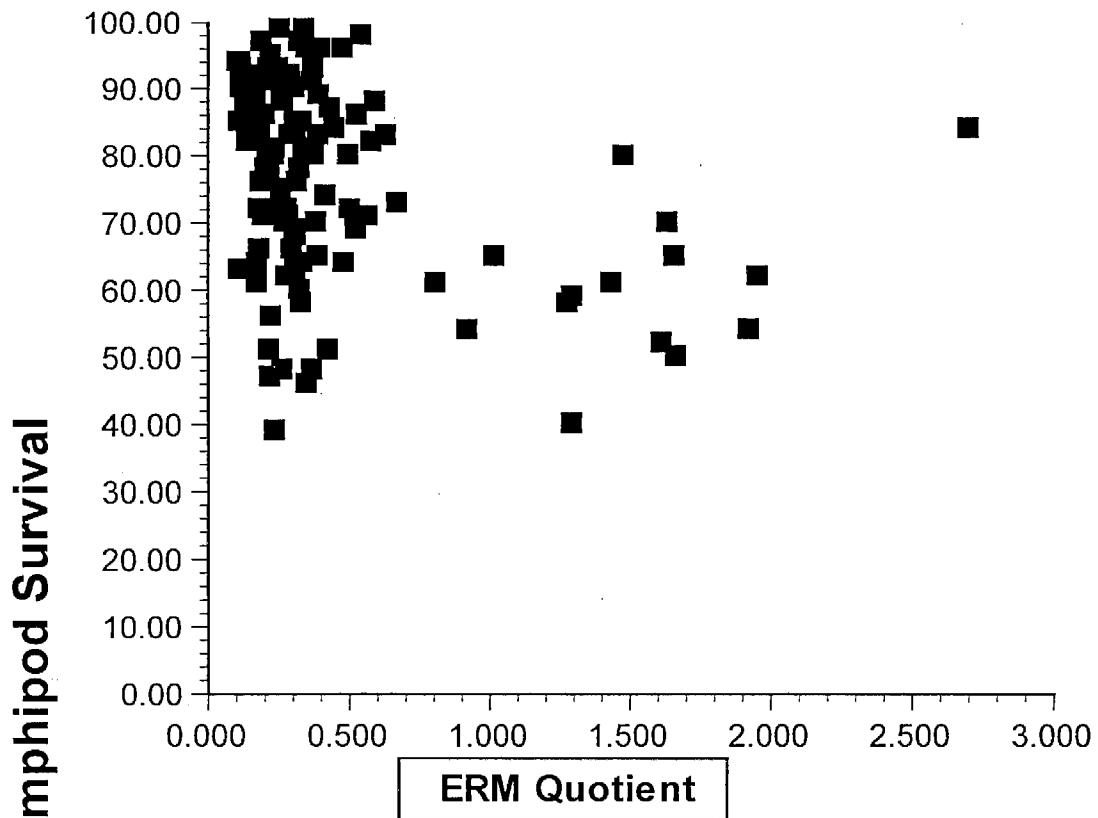
Consolidated Slip of Inner Los Angeles Harbor



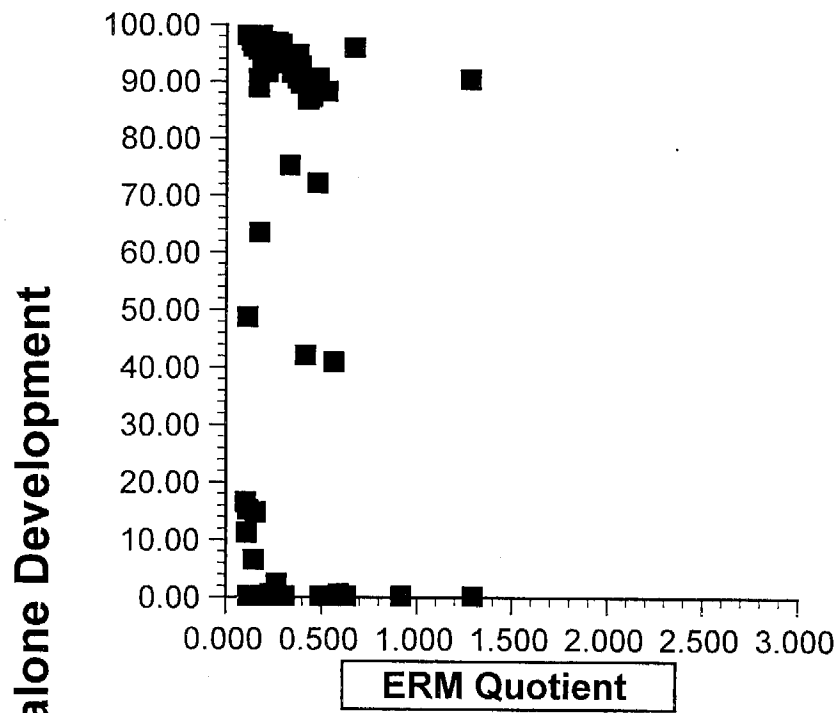
Figures 24a and 24b. Toxicity of Porewater Samples in Inner Los Angeles and Long Beach Harbor (a), and Consolidated Slip (b).



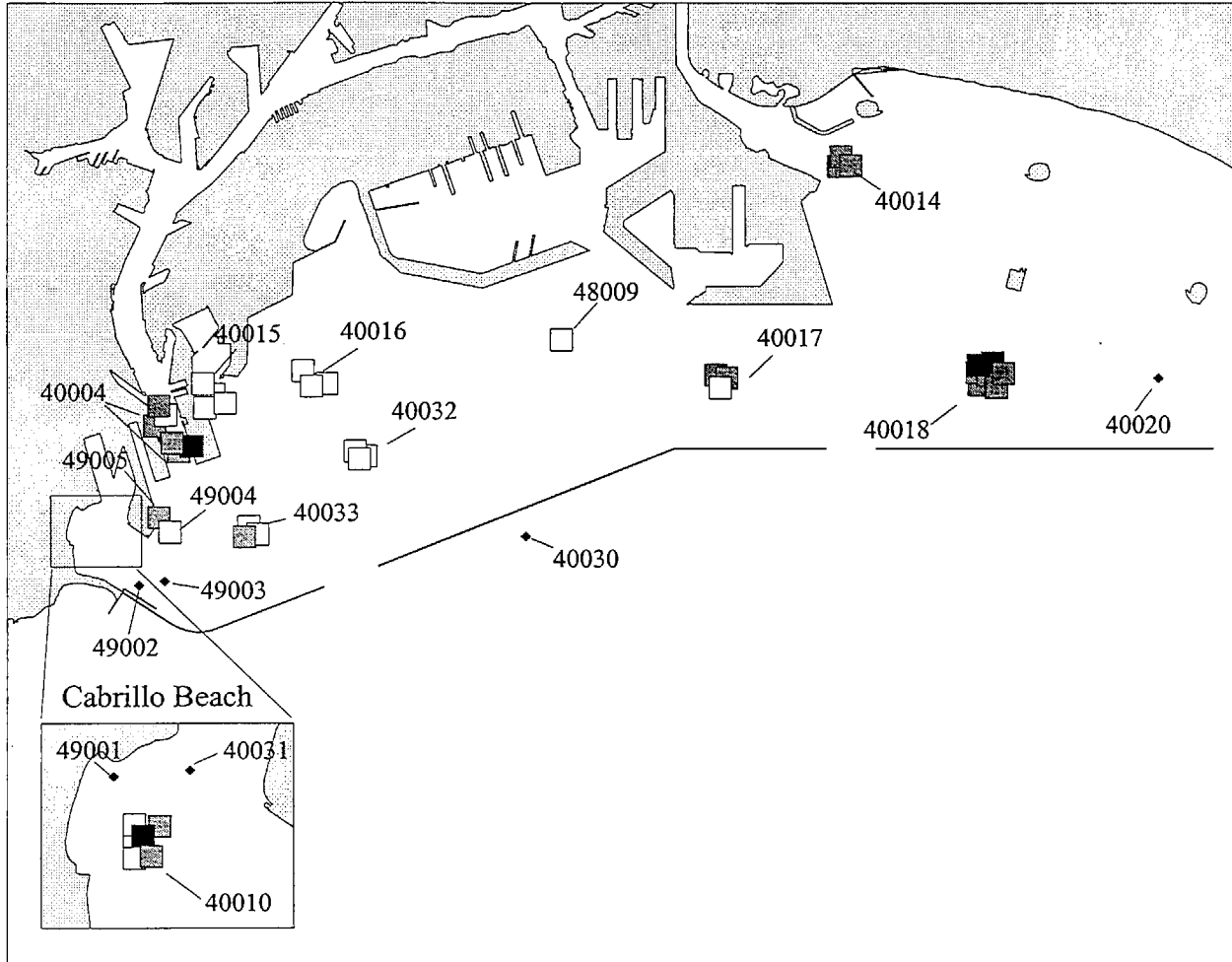
**Figure 25.** Amphipod survival at Industrial Harbor stations in relation to Total Chlordane concentrations. Vertical line indicates ERM value.



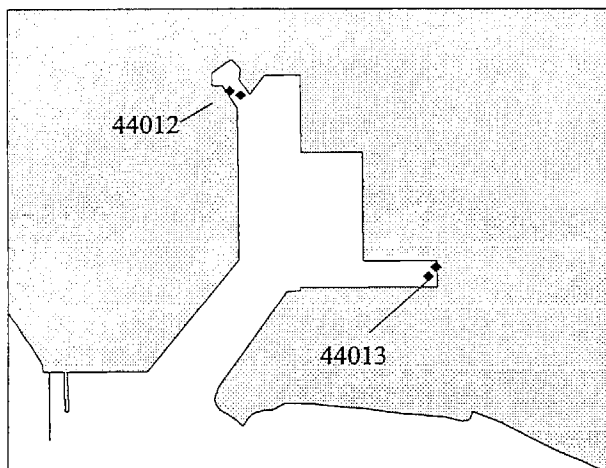
**Figure 26.** Amphipod survival at Industrial Harbor stations in relation to average ERM Quotient and Number of ERM Exceedances.



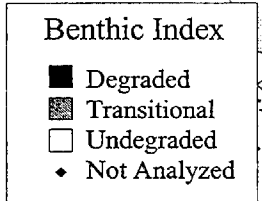
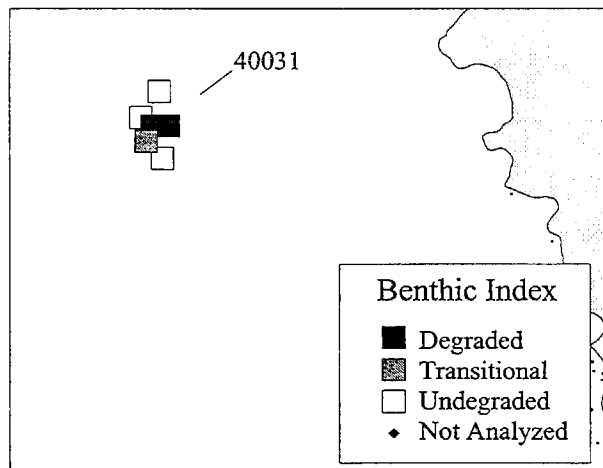
Outer Los Angeles/Long Beach Harbor Stations



Port Hueneme



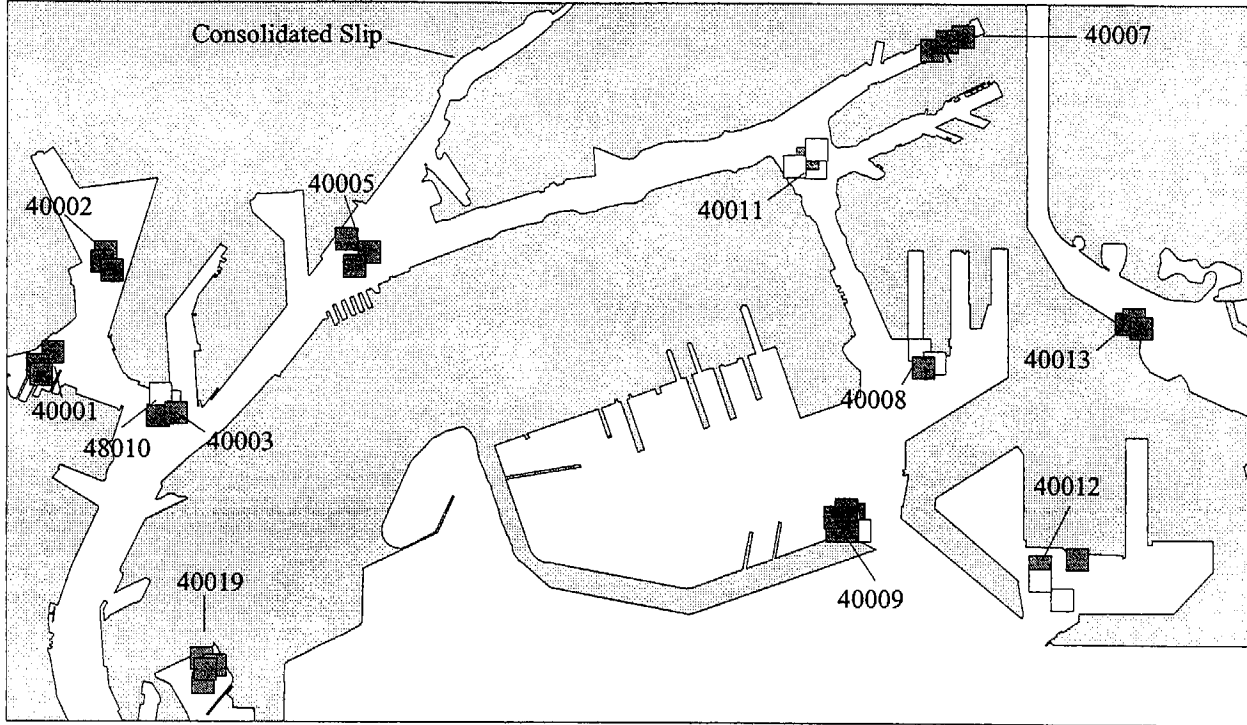
Palos Verdes



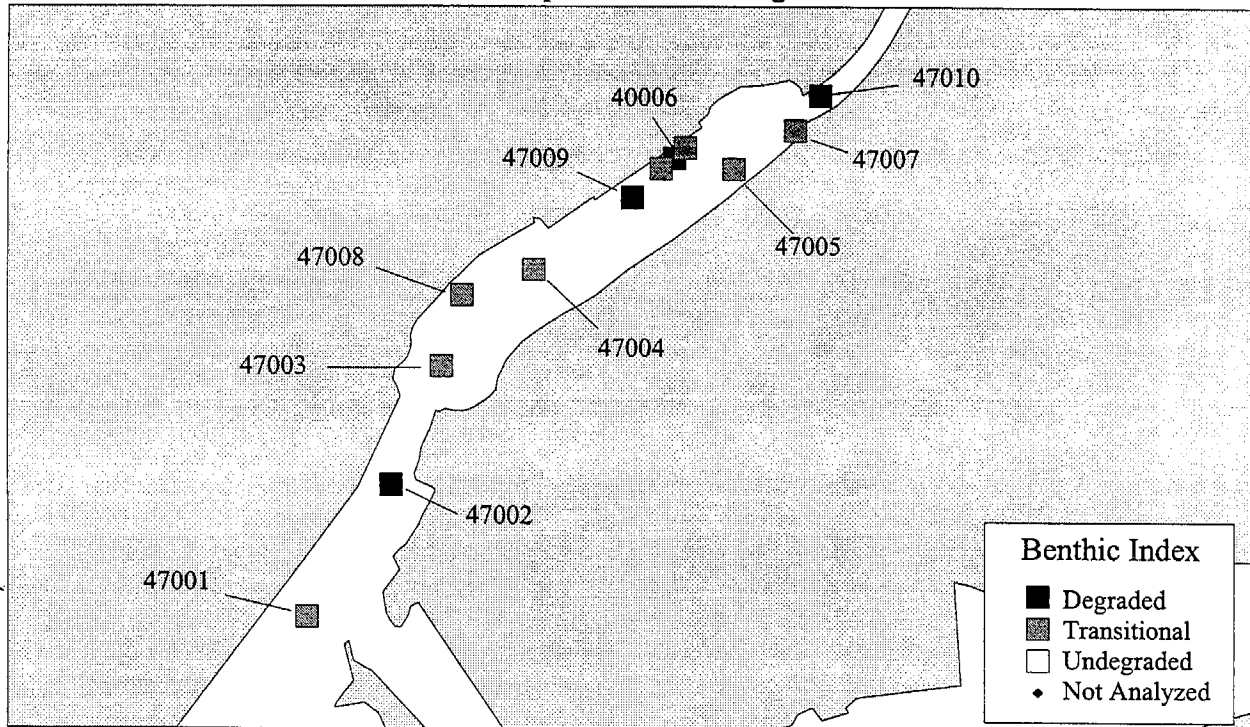
Figures 28a, 28b, and 28c. Distribution of Stations in Outer Los Angeles and Long Beach Harbor (a), Port Hueneme (b), and Palos Verdes (c), Demonstrating Benthic Community Structure.



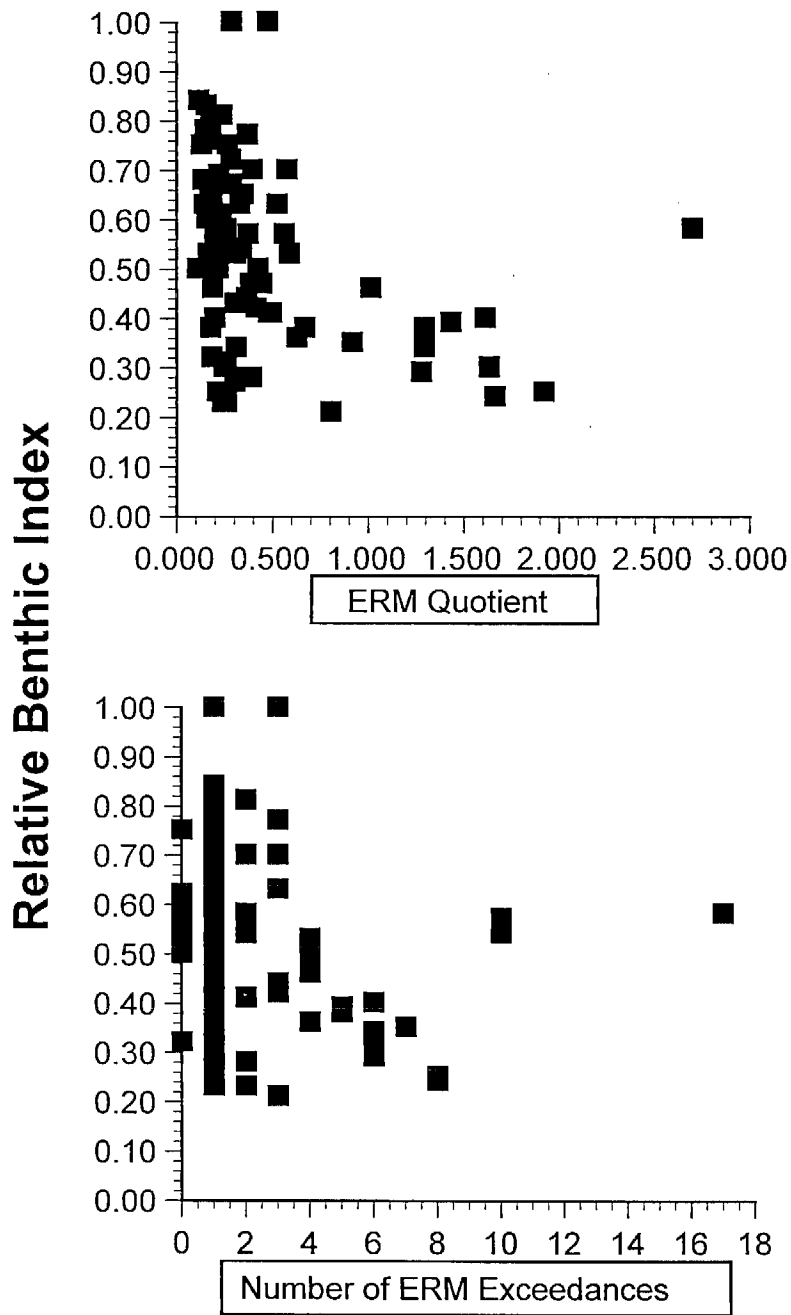
Inner Los Angeles/Long Beach Harbor Stations



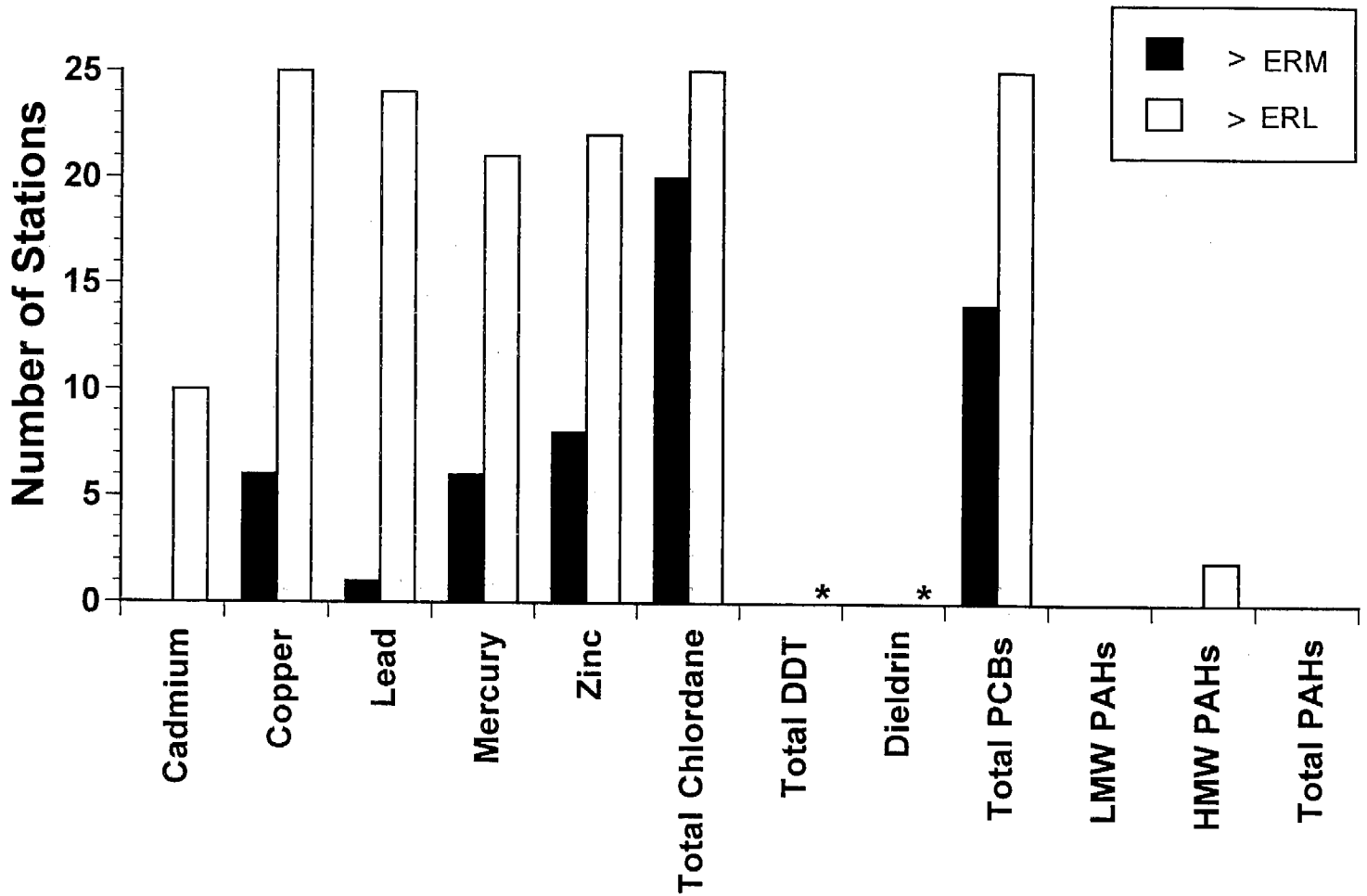
Consolidated Slip of Inner Los Angeles Harbor



Figures 29a and 29b. Distribution of Stations in Inner Los Angeles and Long Beach Harbor (a), and Consolidated Slip (b), Demonstrating Benthic Community Structure.

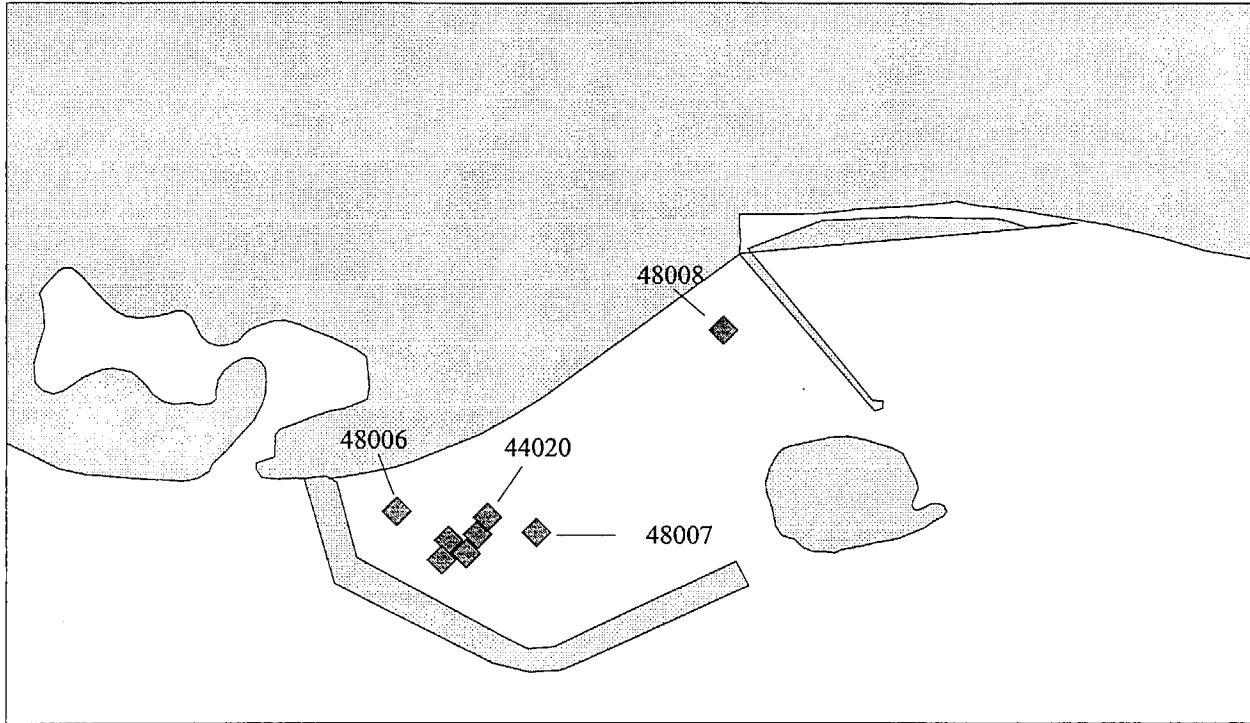


**Figure 30.** Relative Benthic Index at Industrial Harbor stations in relation to ERM Quotient and Number of ERM Exceedances

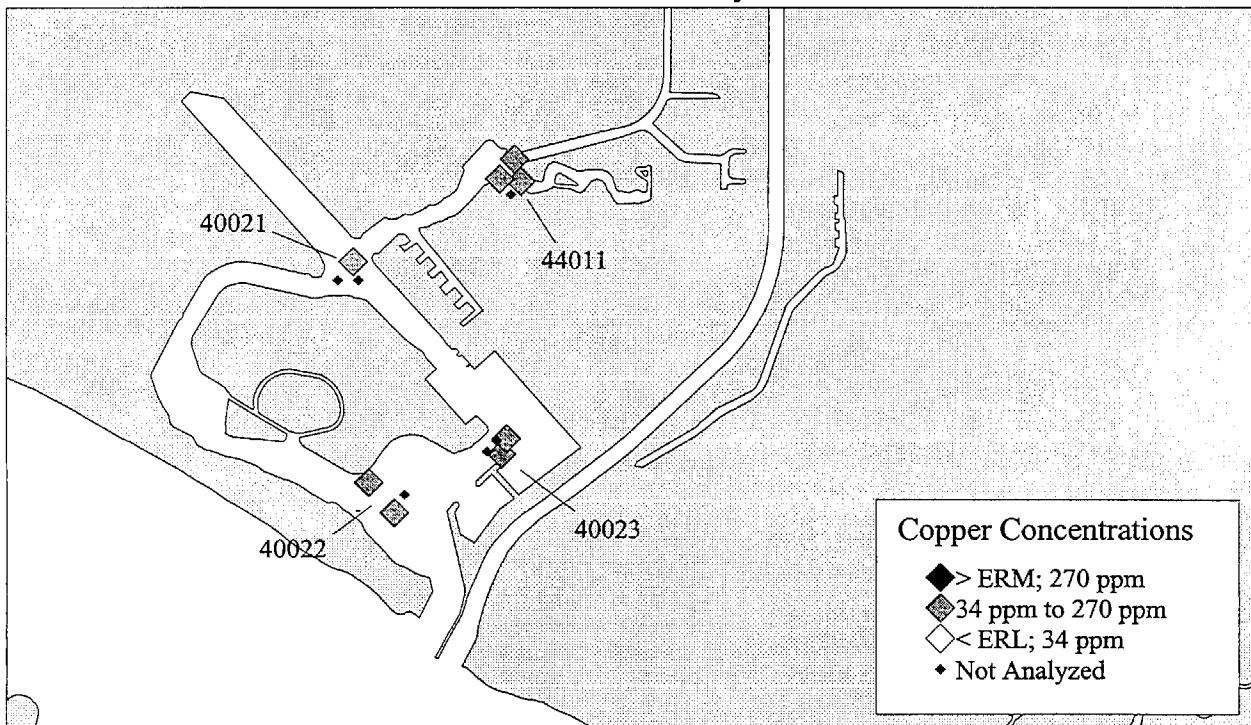


**Figure 31 .** Number of Marina station samples exceeding either the ERM or ERL sediment quality guidelines. (Total DDT was compared to the Swartz *et al.* sediment effect concentration, 100 ug/g OC. \* no ERL exceedances were calculated for Total DDT or Dieldrin; see text for details).

### Shoreline Marina

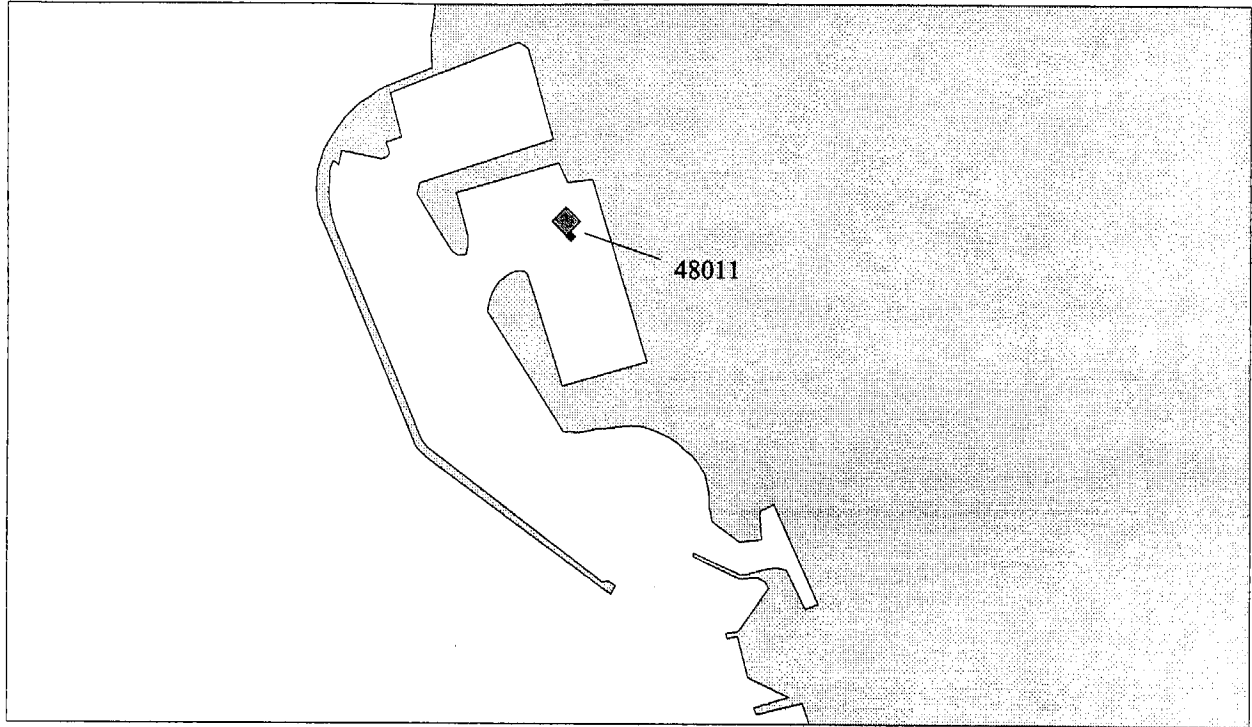


### Los Alamitos Bay

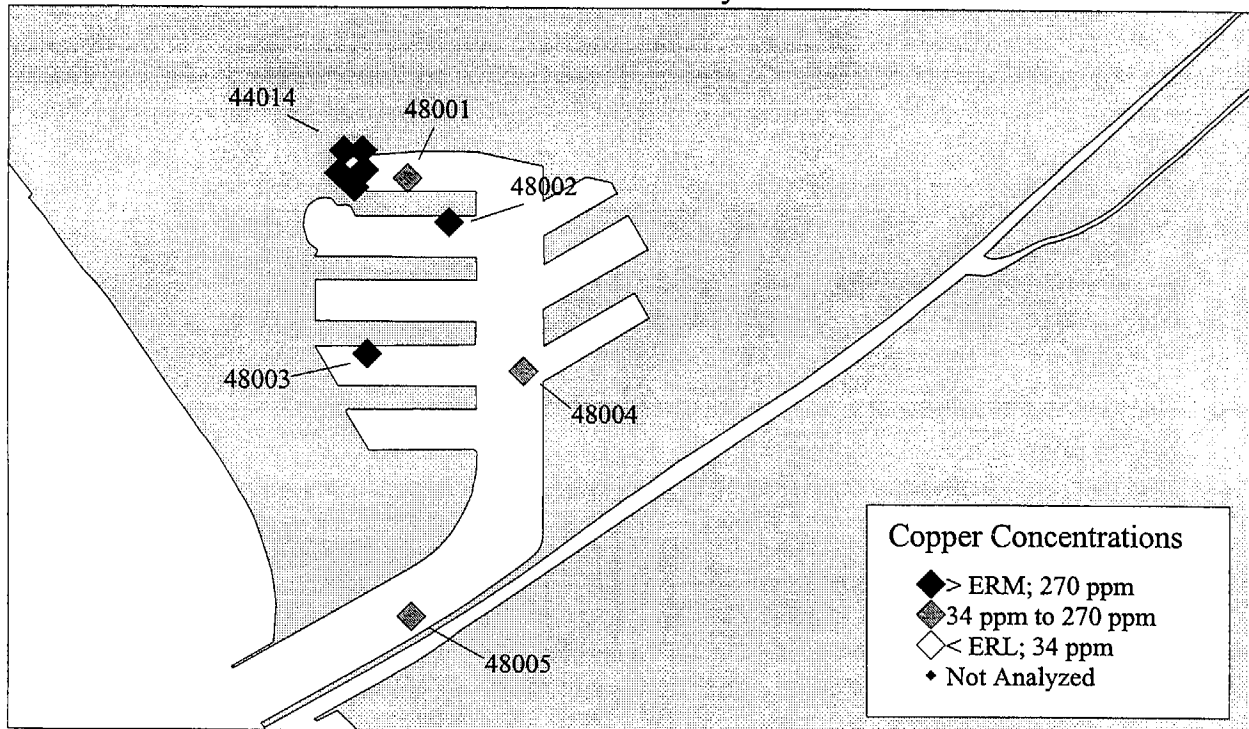


Figures 32a and 32b. Distribution of samples in Shoreline Marina (a), and Los Alamitos Bay (b), exceeding the ERM for Copper.

### King Harbor



### Marina Del Rey



Figures 33a and 33b. Distribution of samples in King Harbor (a), and Marina Del Rey (b), exceeding the ERM for Copper.

Channel Islands Harbor

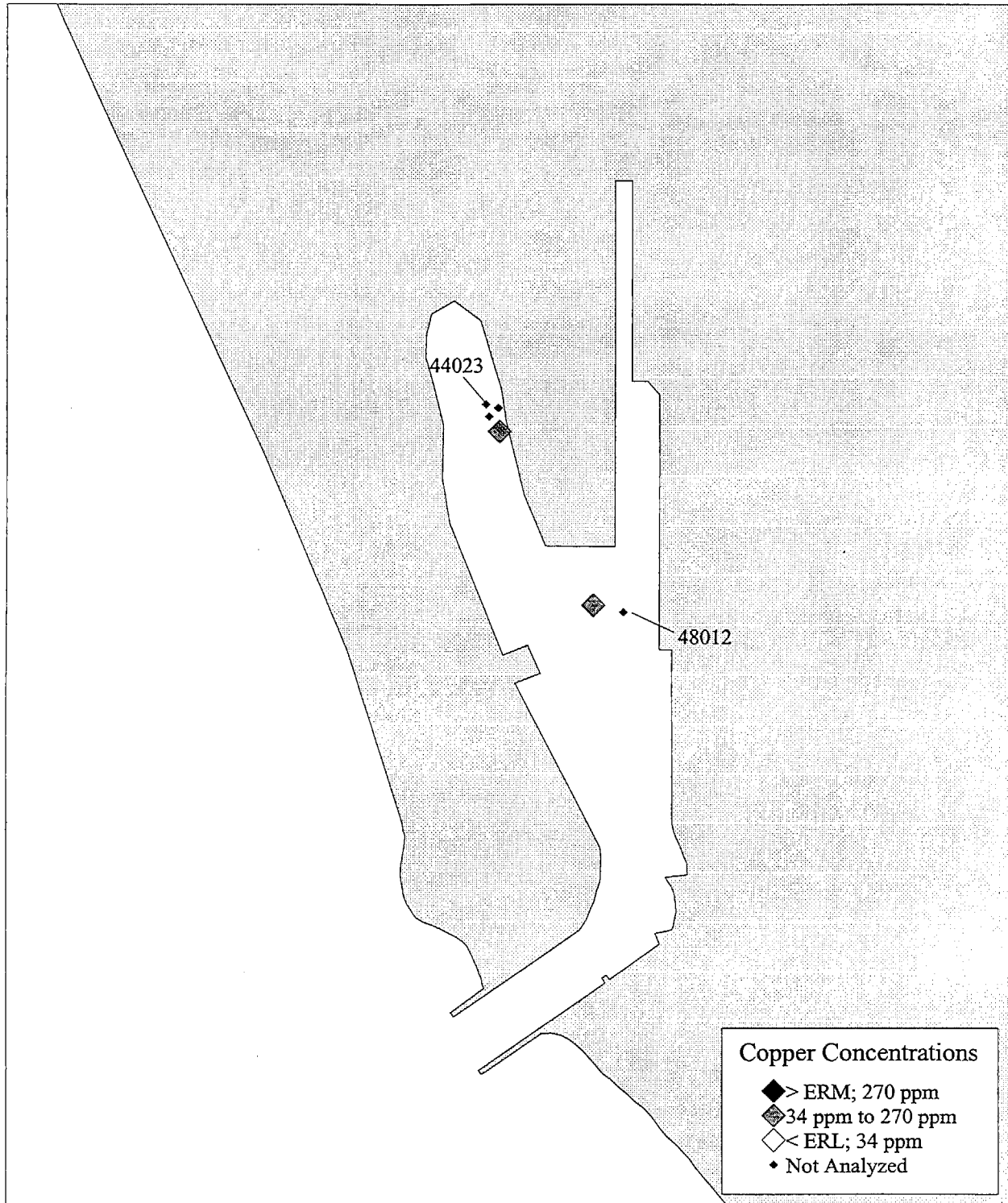
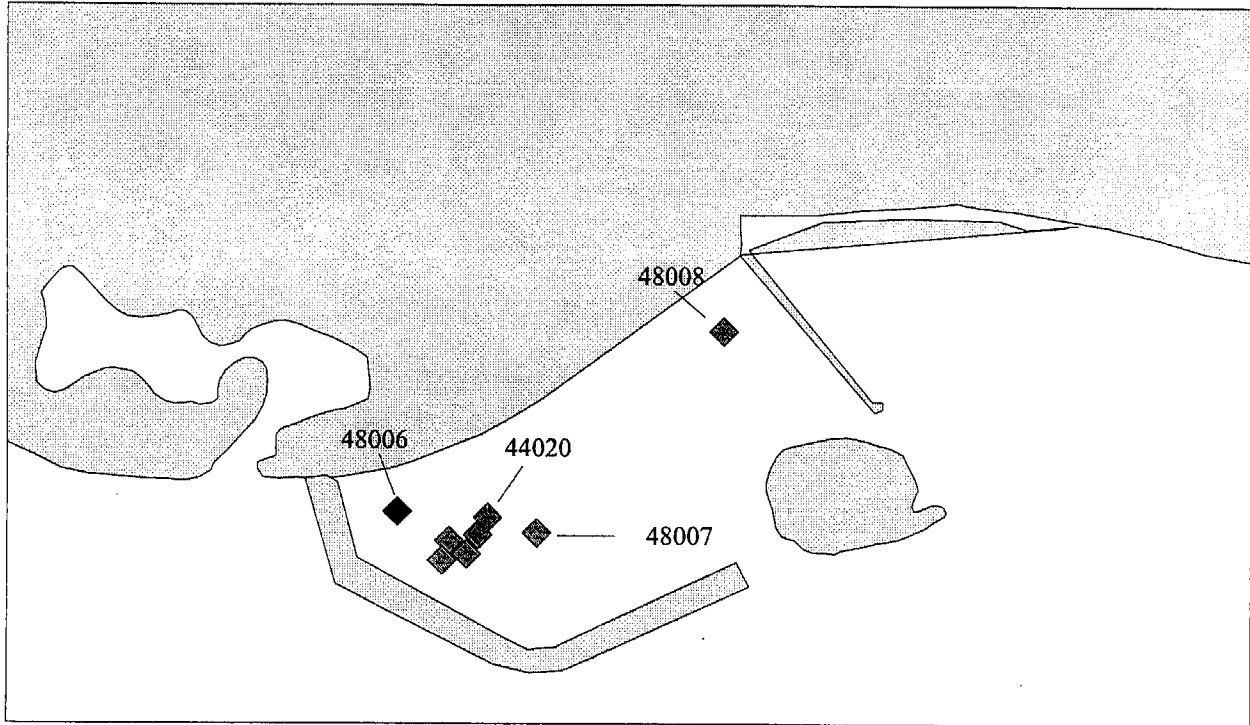
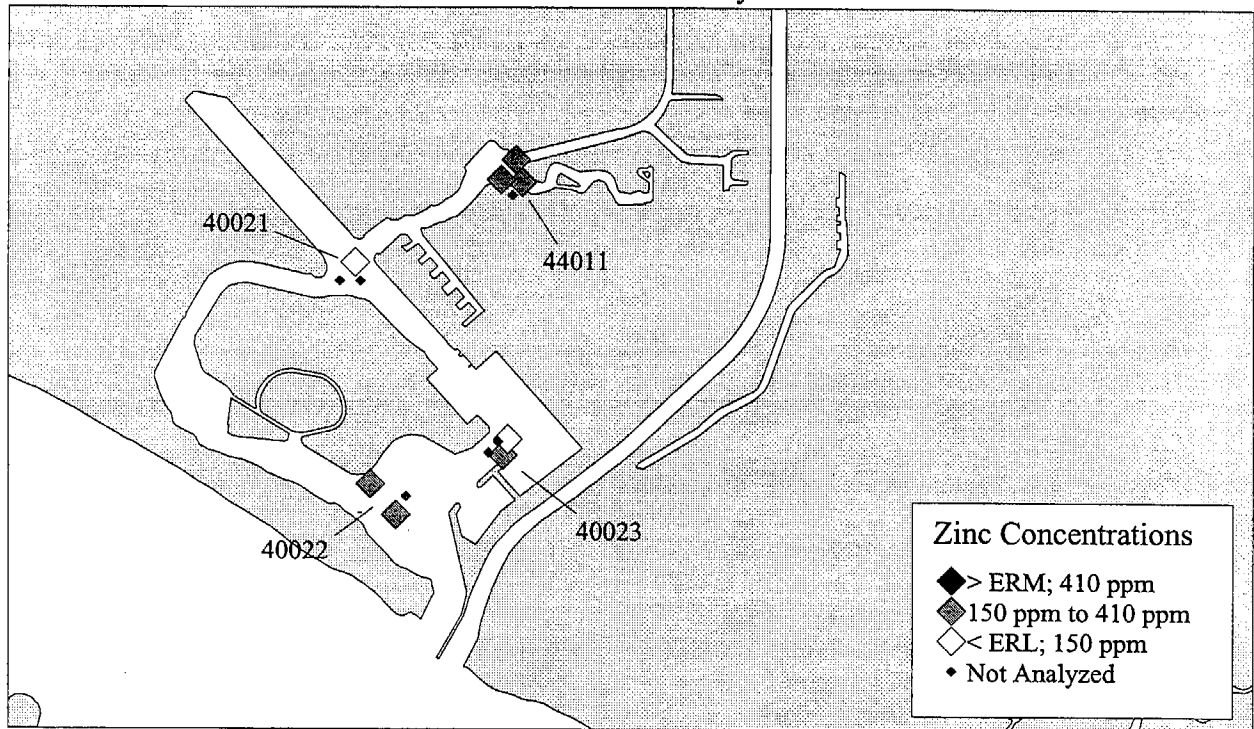


Figure 34. Distribution of samples in Channel Islands Harbor exceeding the ERM for Copper.

### Shoreline Marina

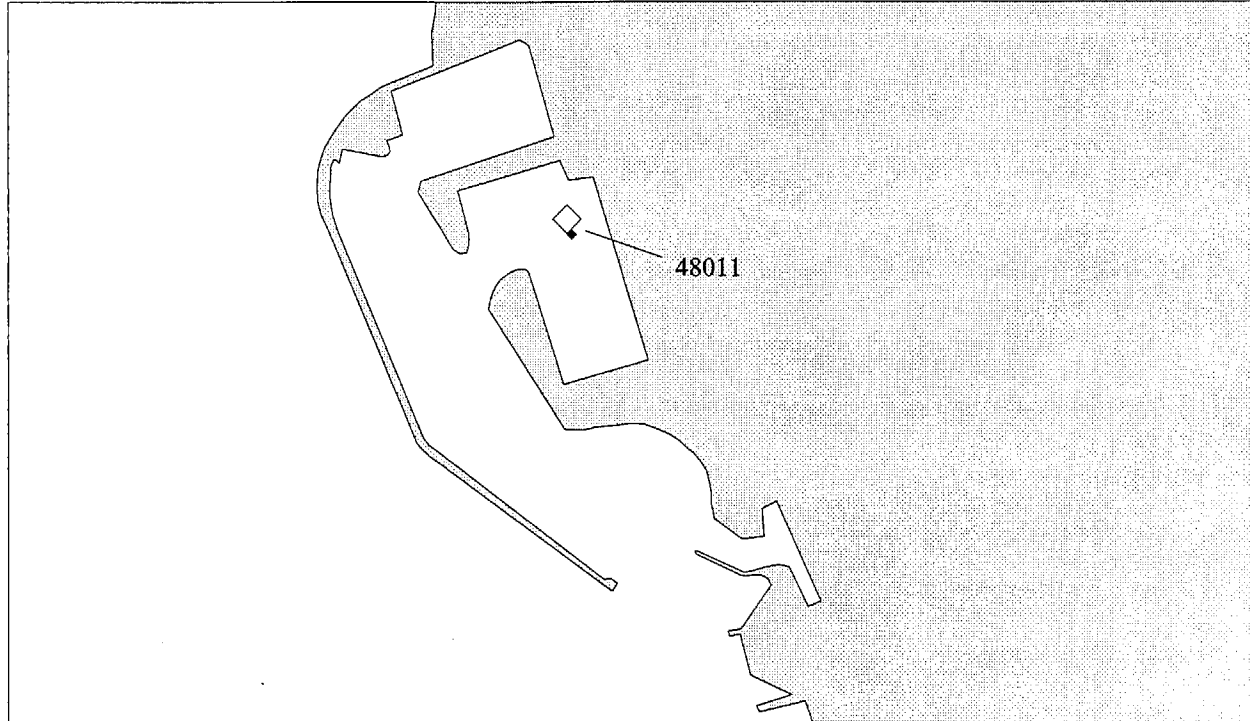


### Los Alamitos Bay

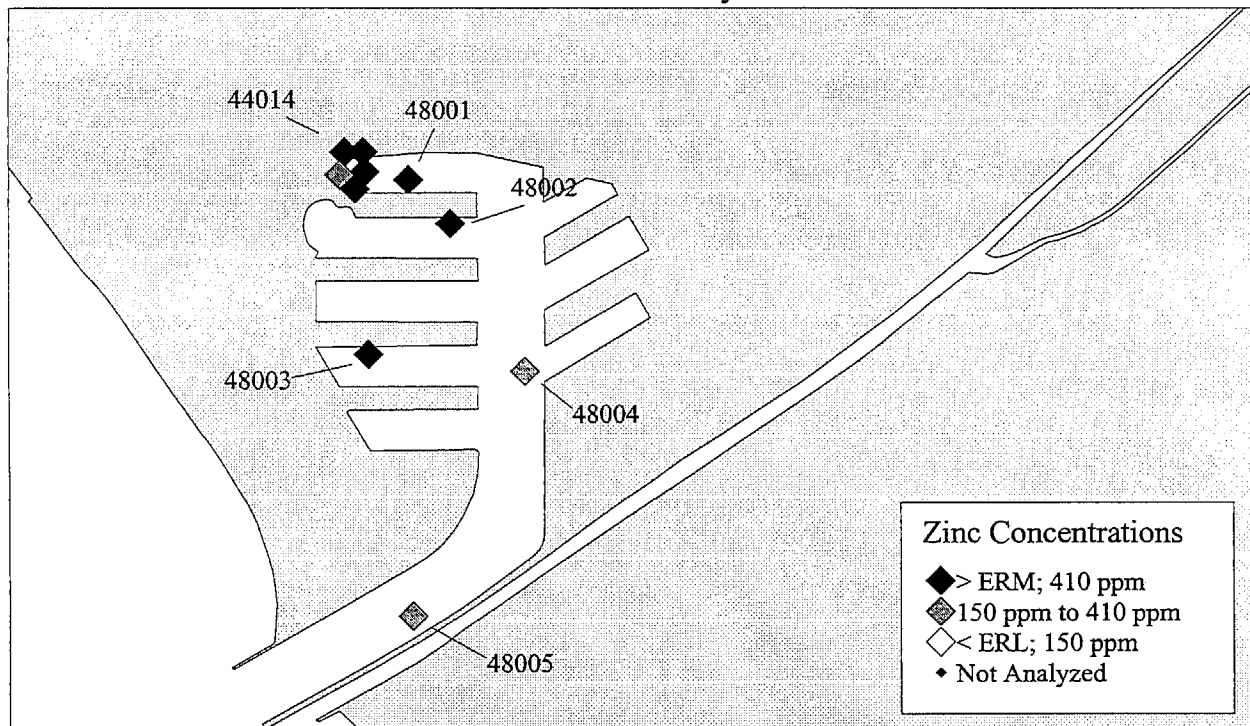


Figures 35a and 35b. Distribution of samples in Shoreline Marina (a), and Los Alamitos Bay (b), exceeding the ERM for Zinc

### King Harbor



### Marina Del Rey



Figures 36a and 36b. Distribution of samples in King Harbor (a), and Marina Del Rey (b), exceeding the ERM for Zinc



Channel Islands Harbor

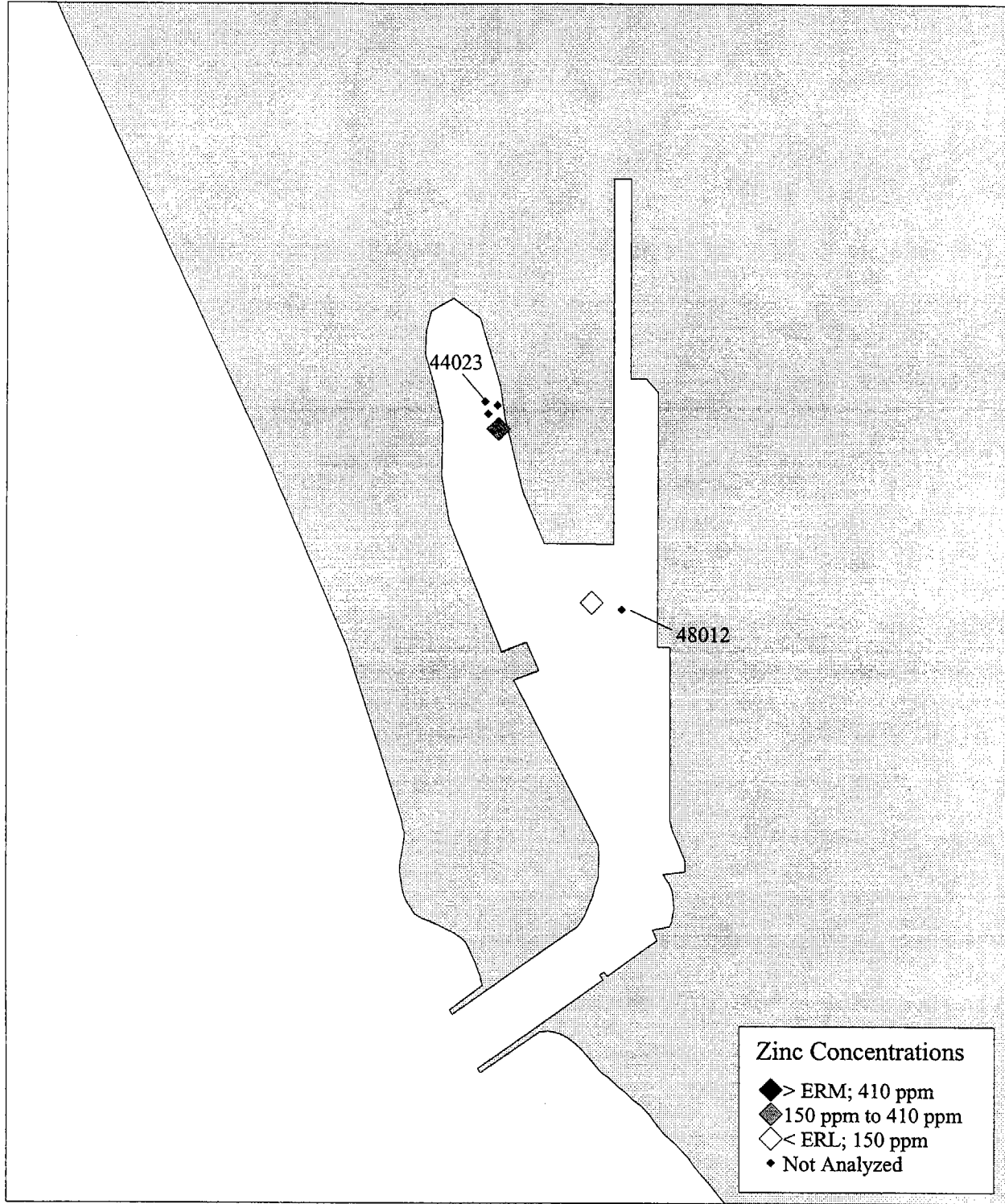
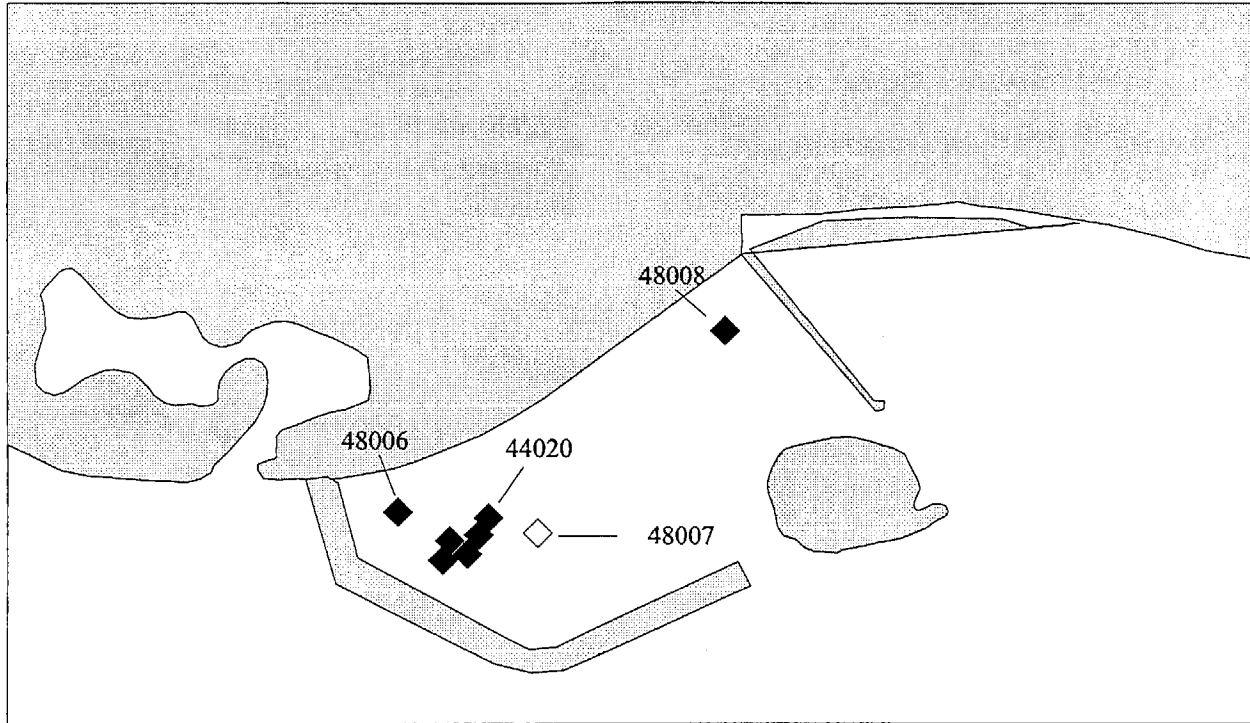
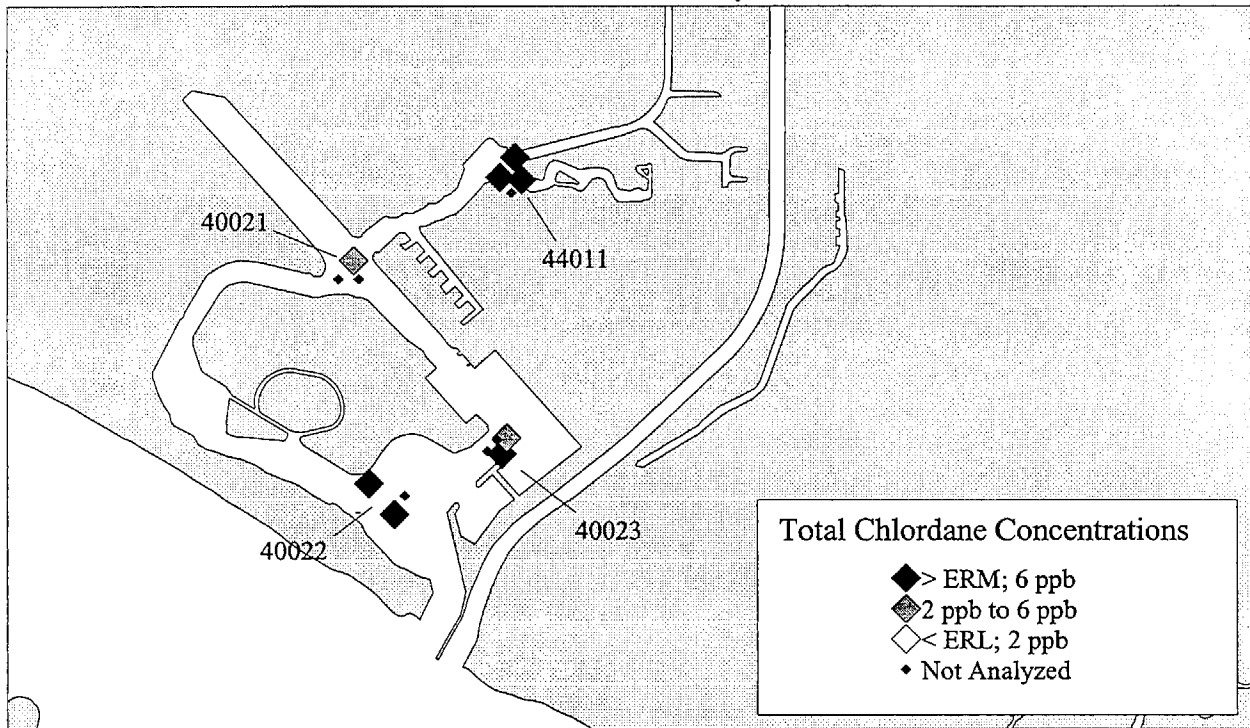


Figure 37. Distribution of samples in Channel Islands Harbor exceeding the ERM for Zinc.

### Shoreline Marina

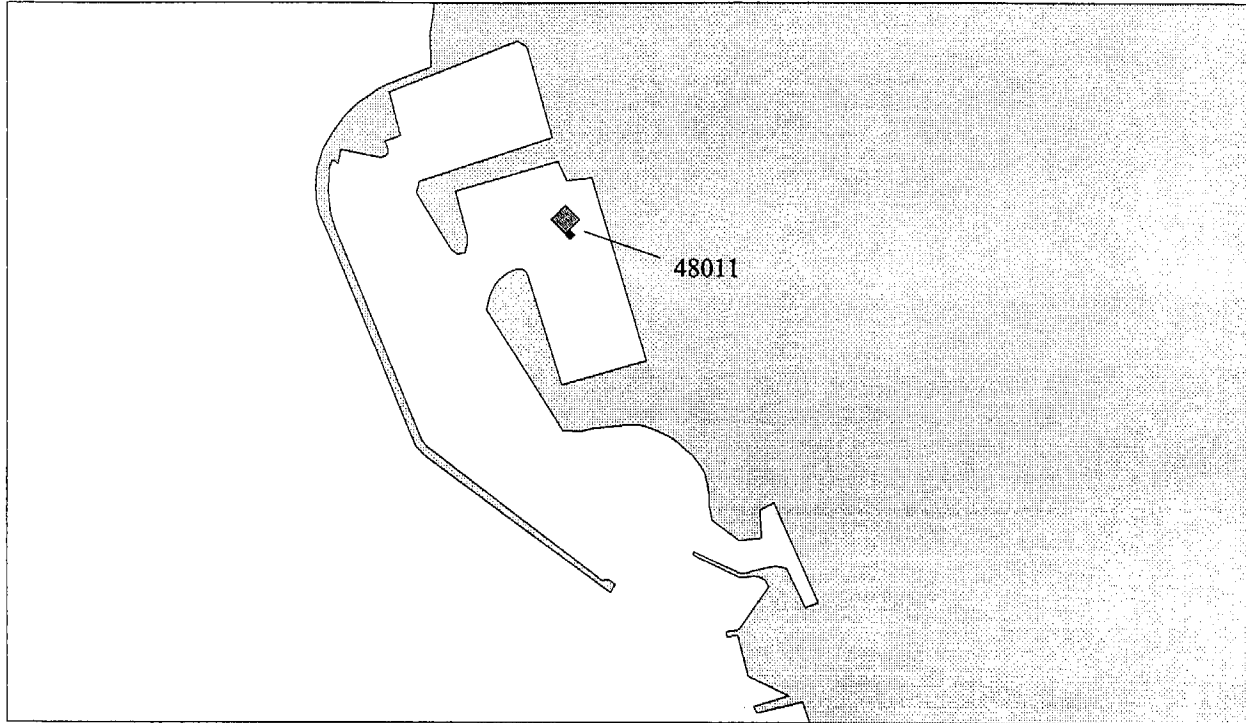


### Los Alamitos Bay

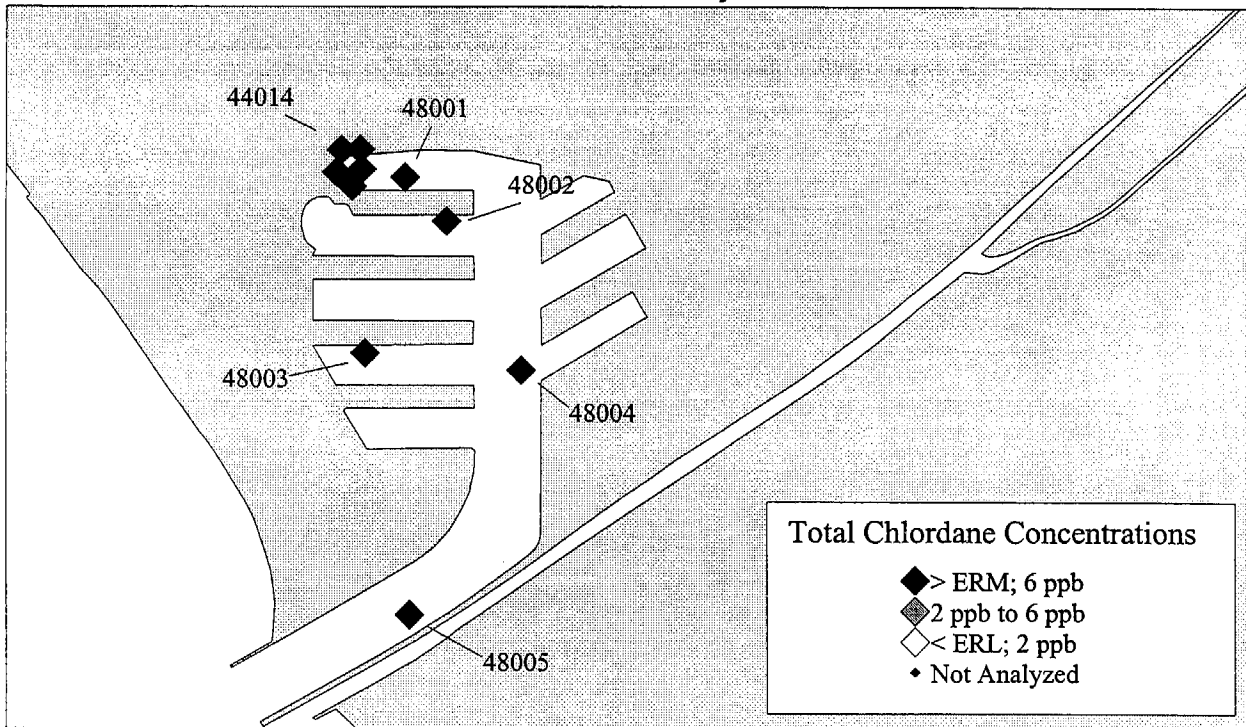


Figures 38a and 38b. Distribution of samples in Shoreline Marina (a), and Los Alamitos Bay (b), exceeding the ERM for Total Chlordane.

King Harbor



Marina Del Rey



Figures 39a and 39b. Distribution of samples in King Harbor (a), and Marina Del Rey (b), exceeding the ERM for Total Chlordane.

# Channel Islands Harbor

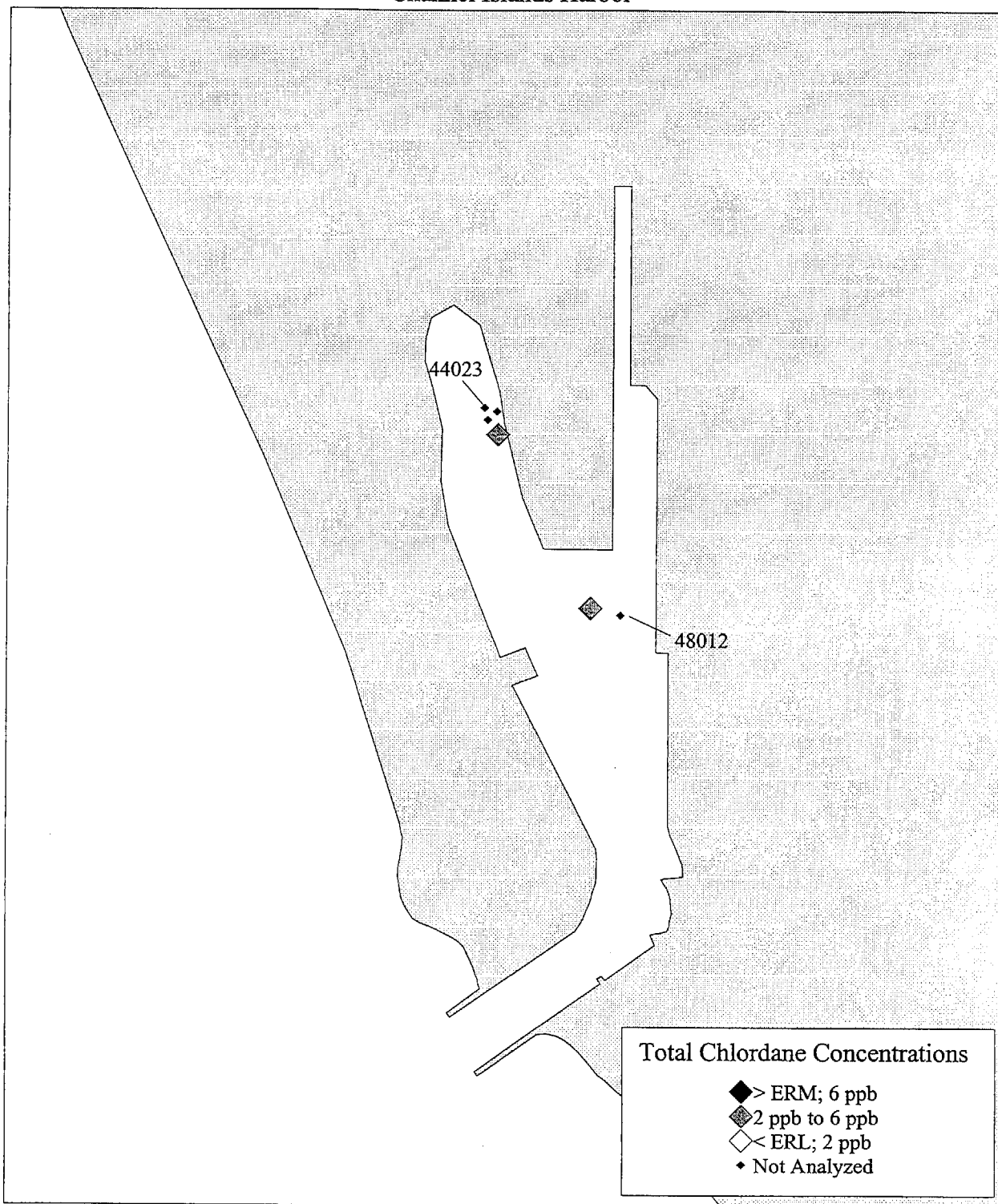
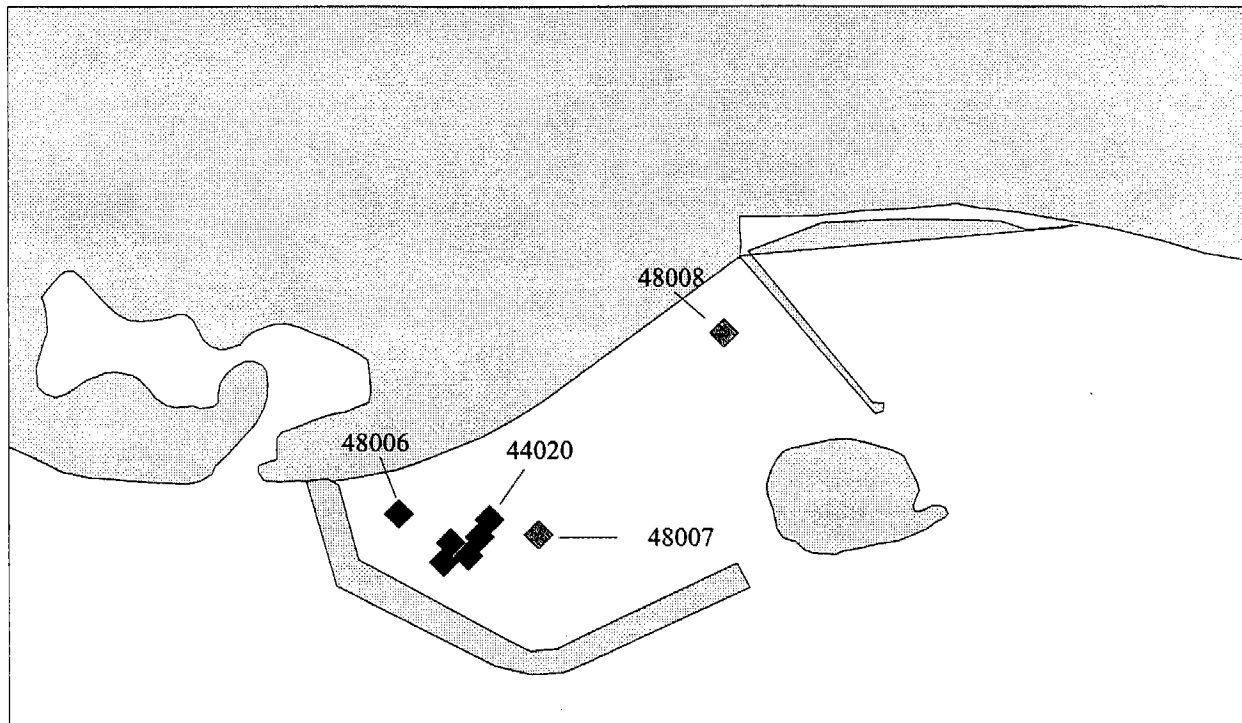
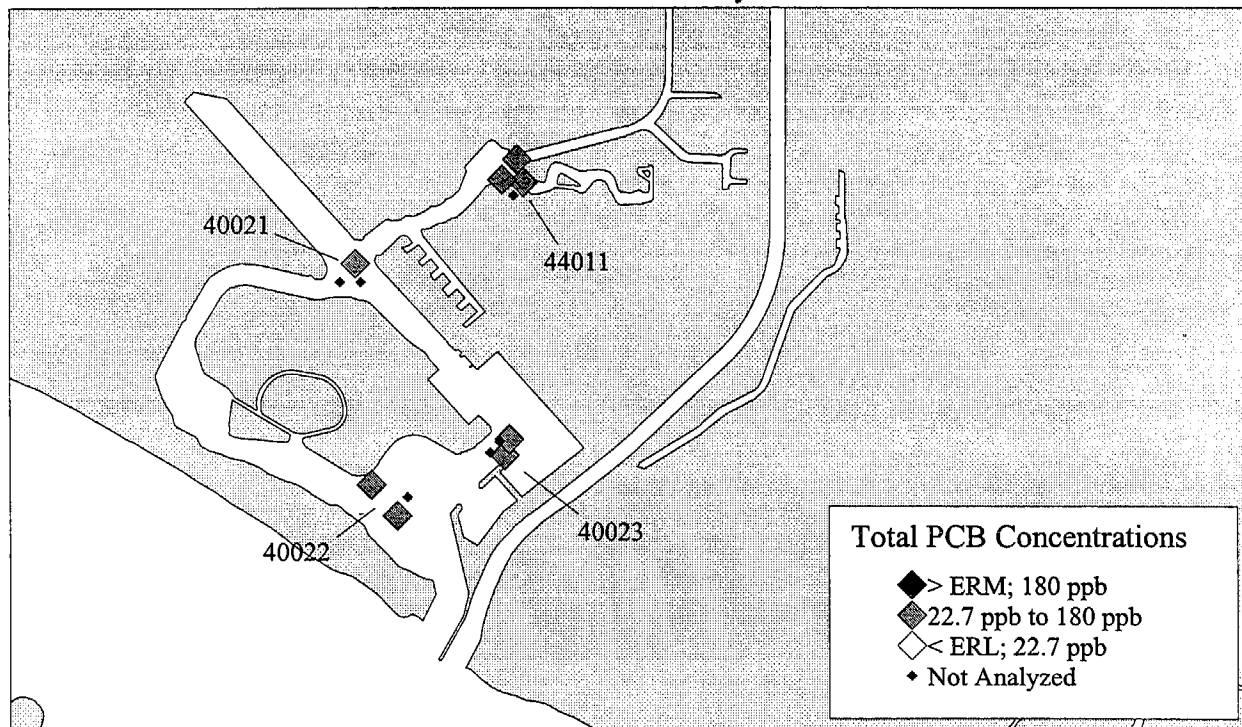


Figure 40. Distribution of samples in Channel Islands Harbor exceeding the ERM for Total Chlordane.

### Shoreline Marina

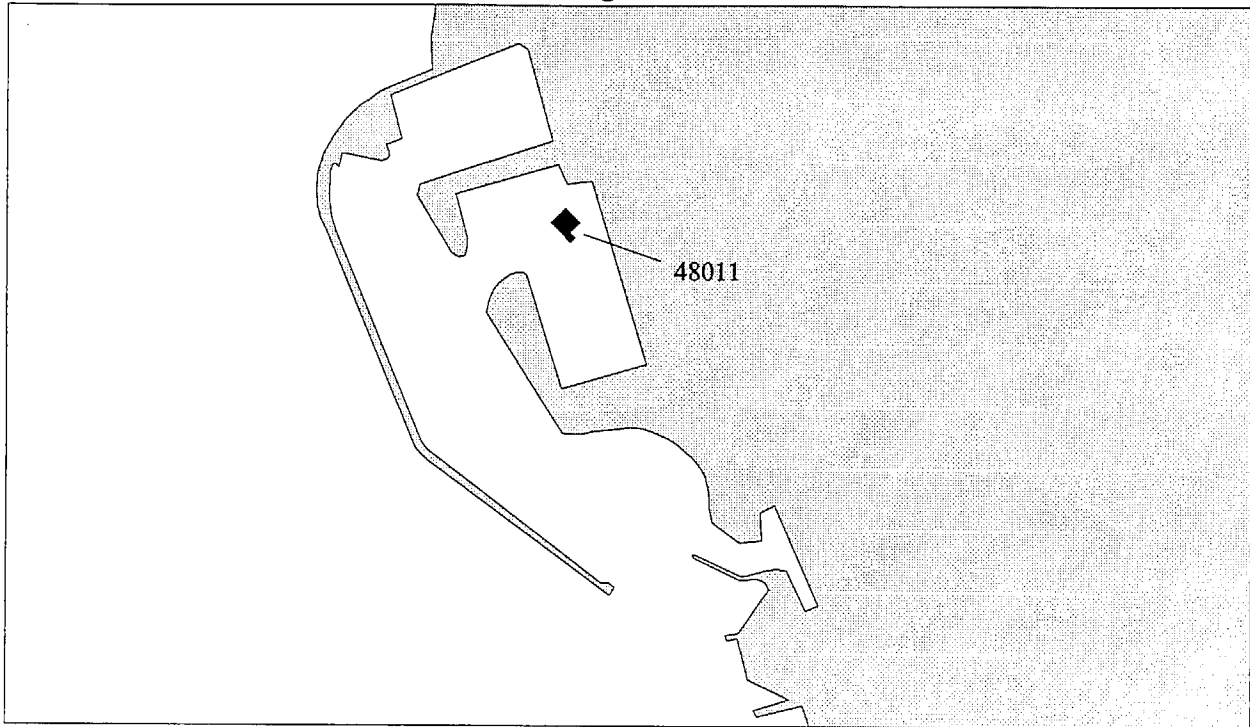


### Los Alamitos Bay

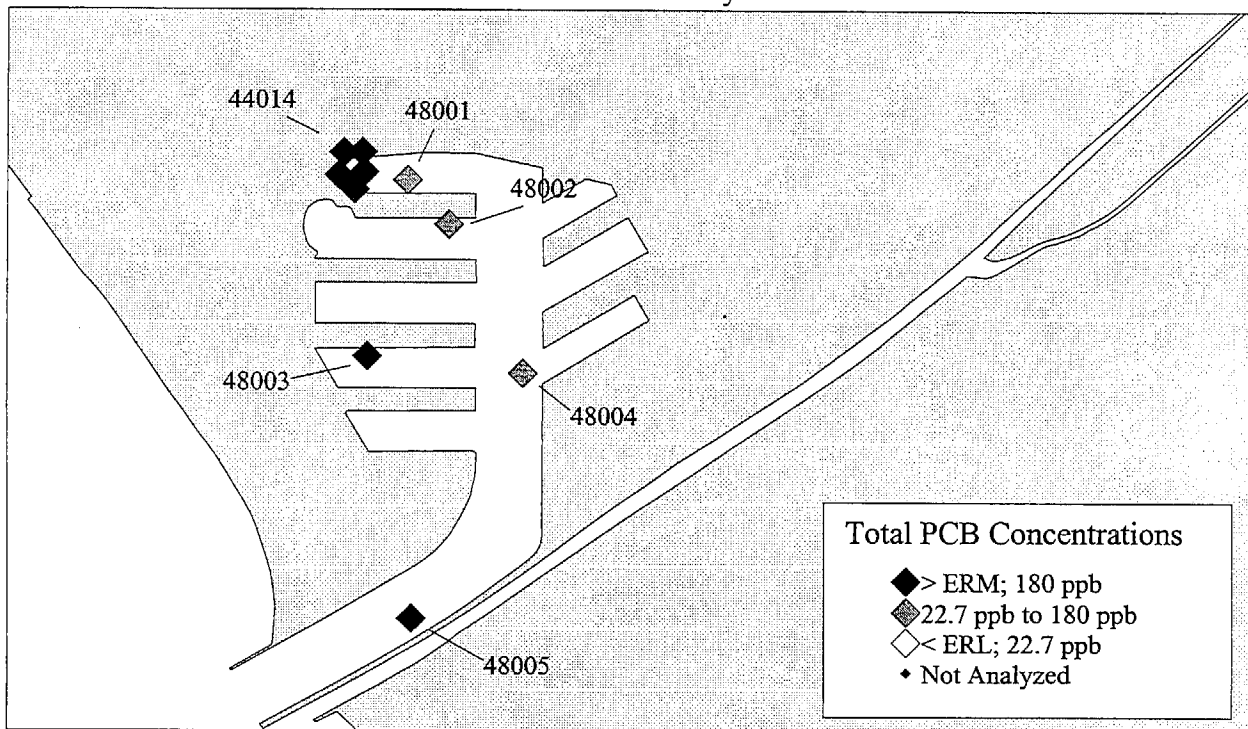


Figures 41a and 41b. Distribution of samples in Shoreline Marina (a), and Los Alamitos Bay (b), exceeding the ERM for Total PCB.

King Harbor

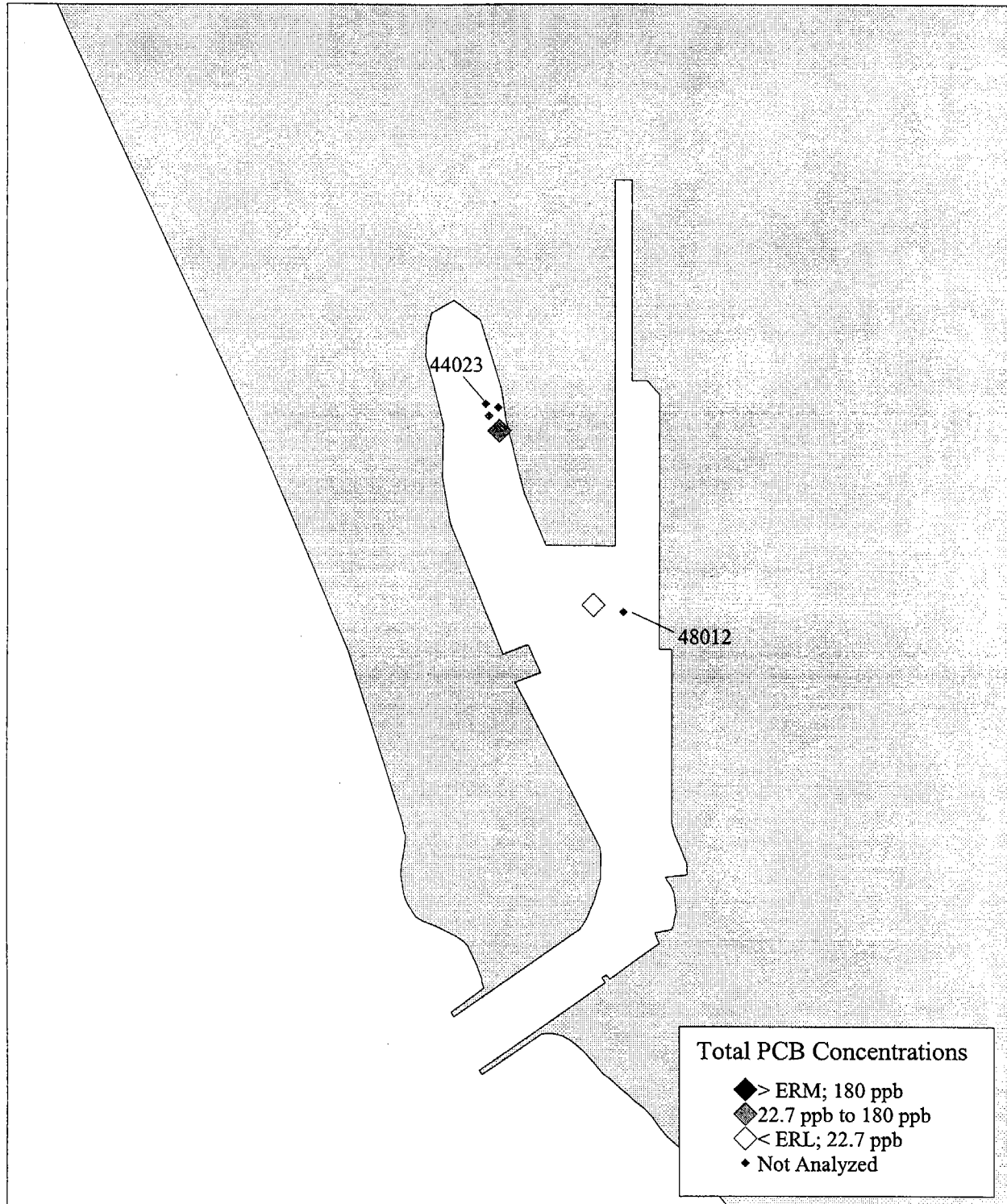


Marina Del Rey



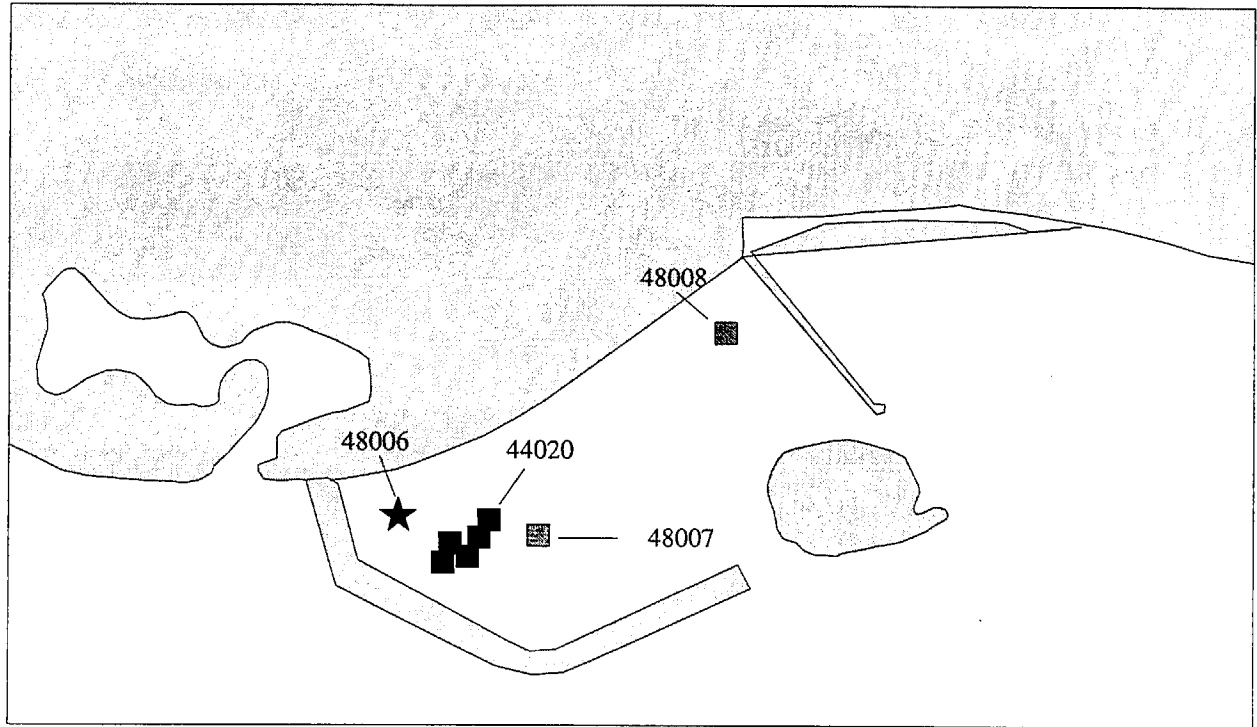
Figures 42a and 42b. Distribution of samples in King Harbor (a), and Marina Del Rey (b), exceeding the ERM for Total PCB.

# Channel Islands Harbor

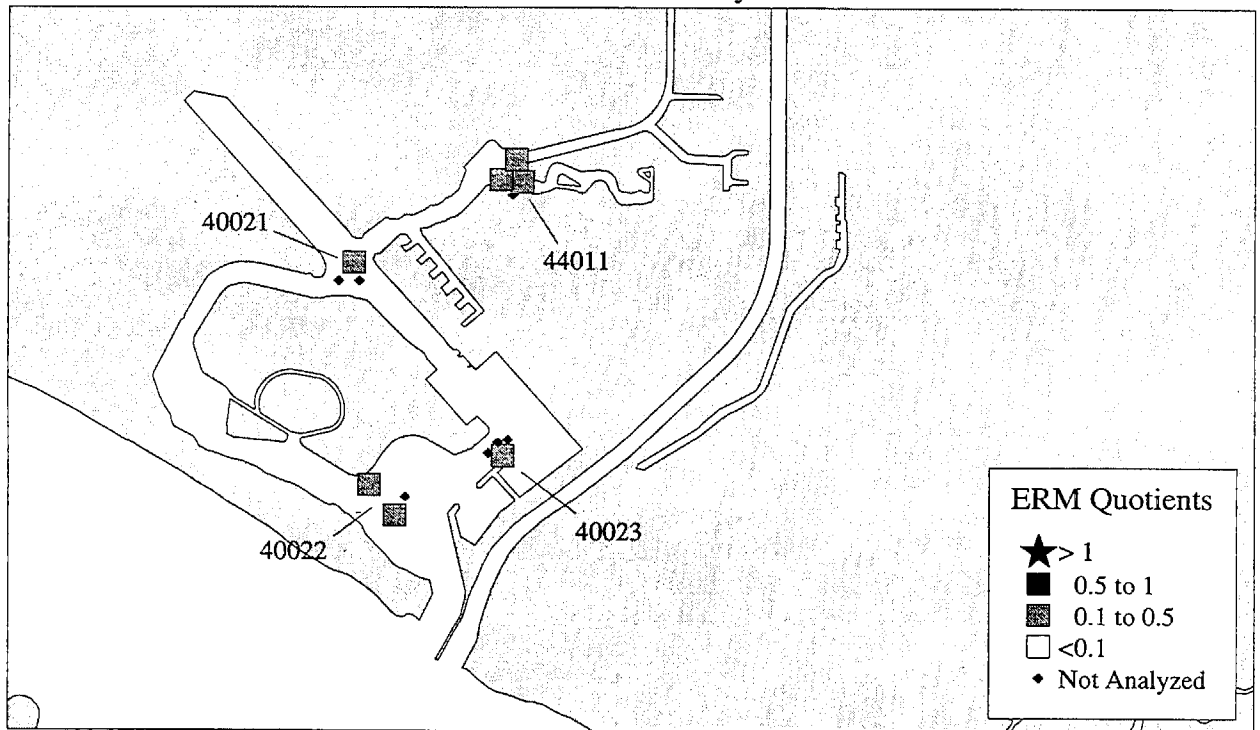


Figures 43. Distribution of samples in Channel Islands Harbor exceeding the ERM for Total PCB.

### Shoreline Marina



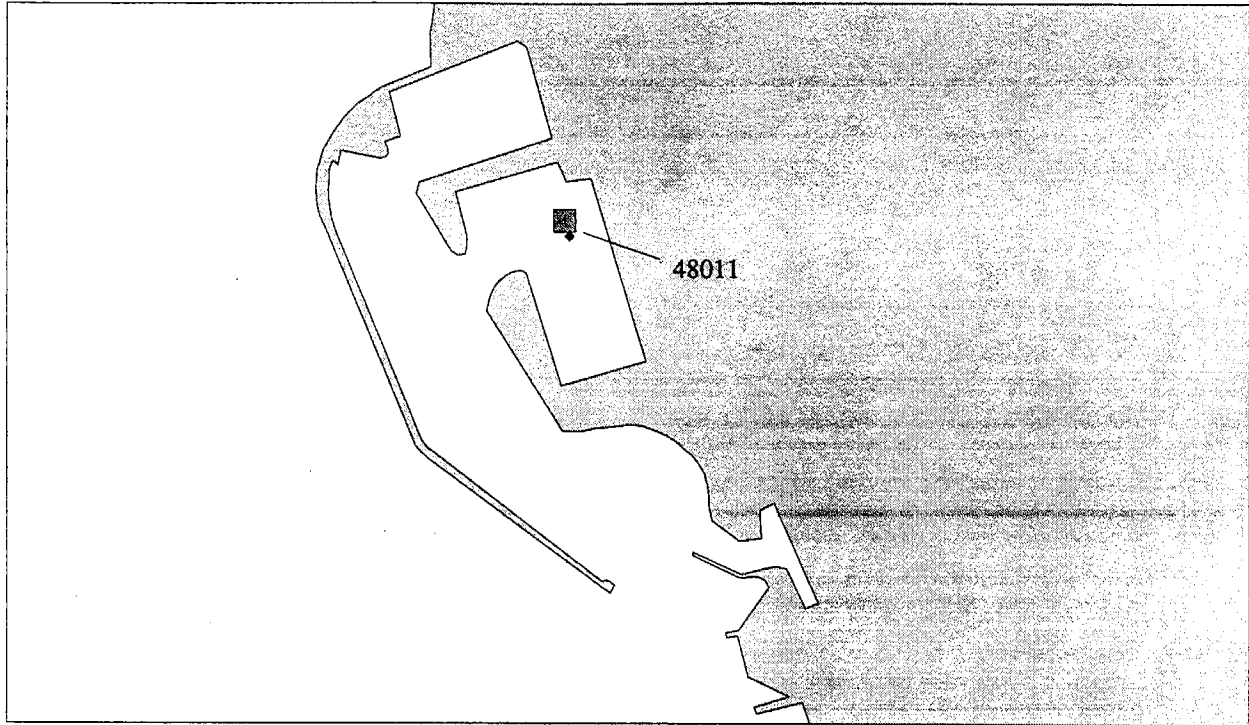
### Los Alamitos Bay



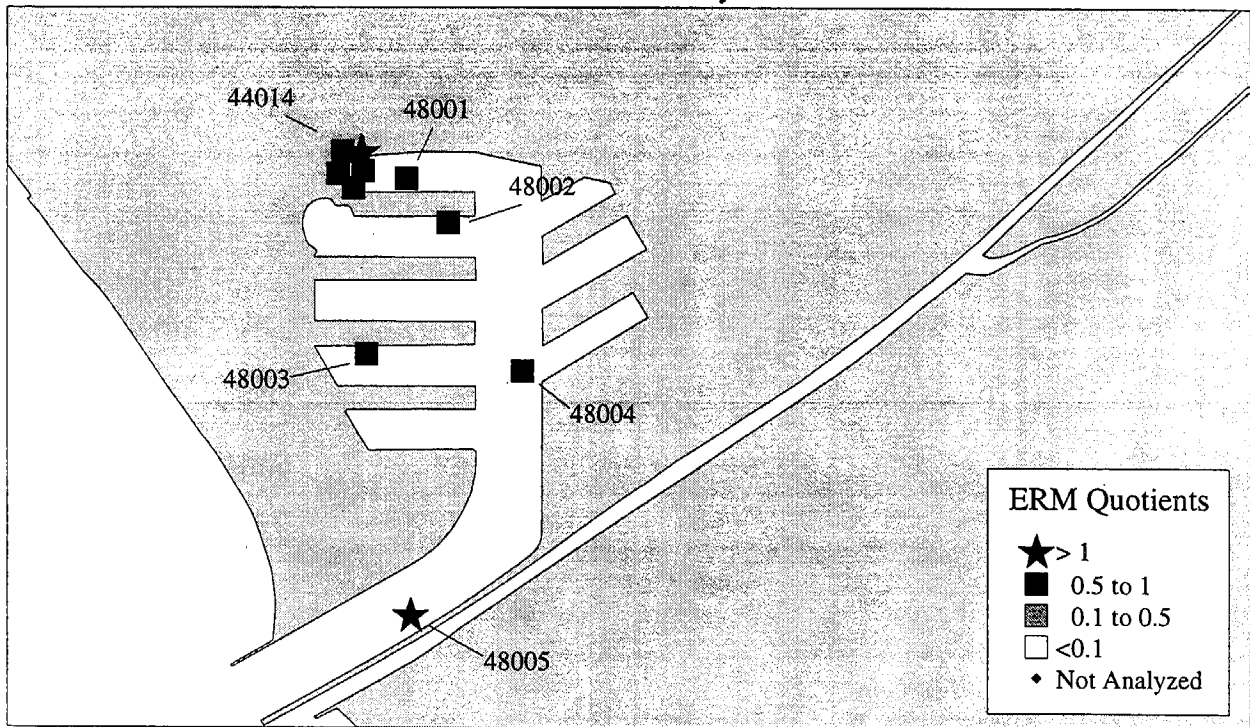
Figures 44a and 44b. ERM Quotient values at Shoreline Marina (a), and Los Alamitos Bay (b), Sampling Stations.



### King Harbor



### Marina Del Rey



Figures 45a and 45b. ERM Quotient values at King Harbor (a), and Marina Del Rey (b), Sampling Stations.

Channel Islands Harbor

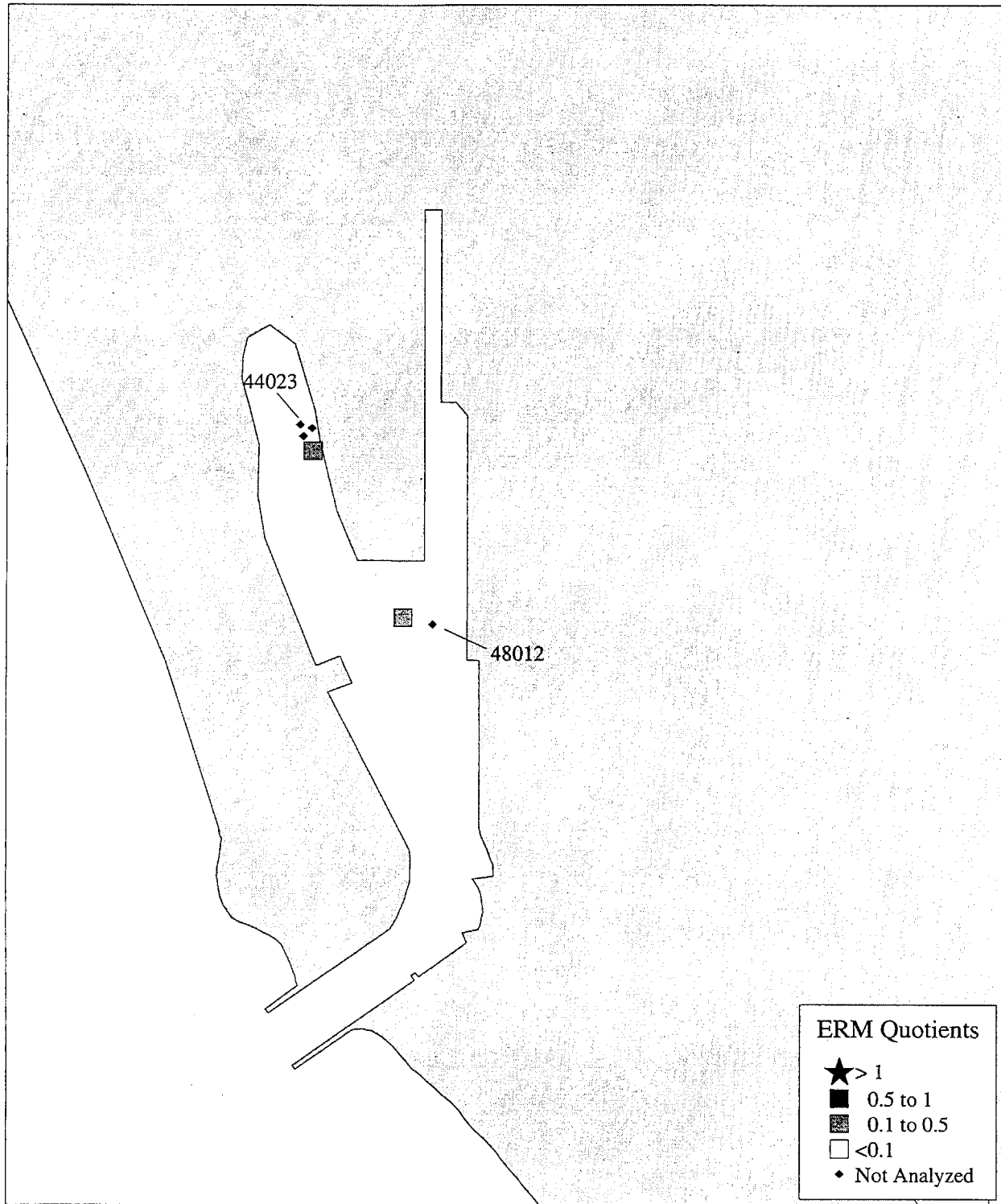
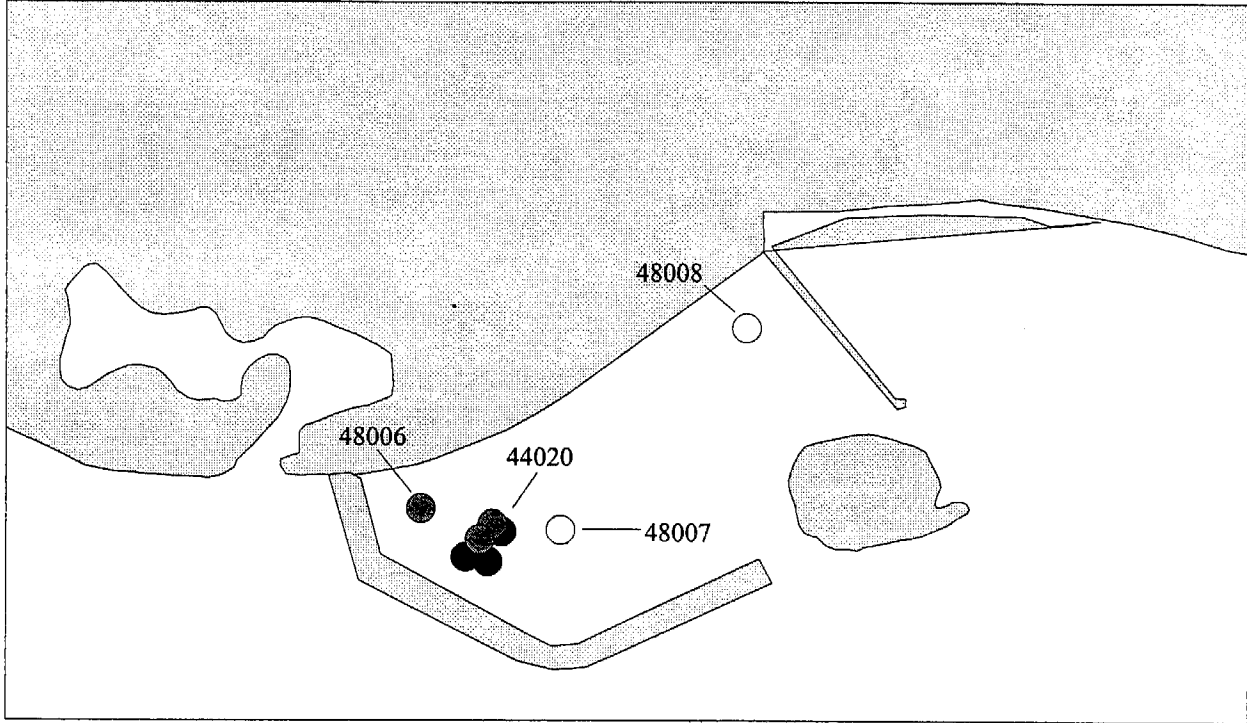
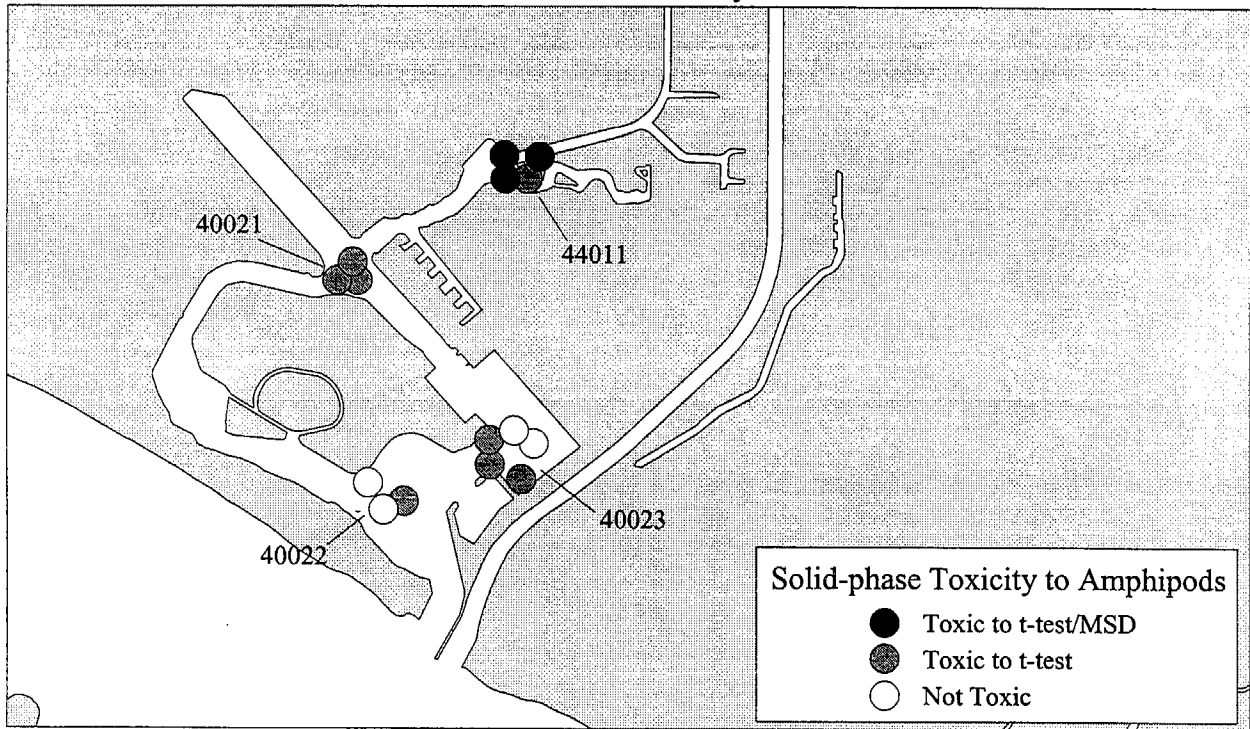


Figure 46. ERM Quotient values at Channel Islands Harbor Sampling Stations.

Shoreline Marina

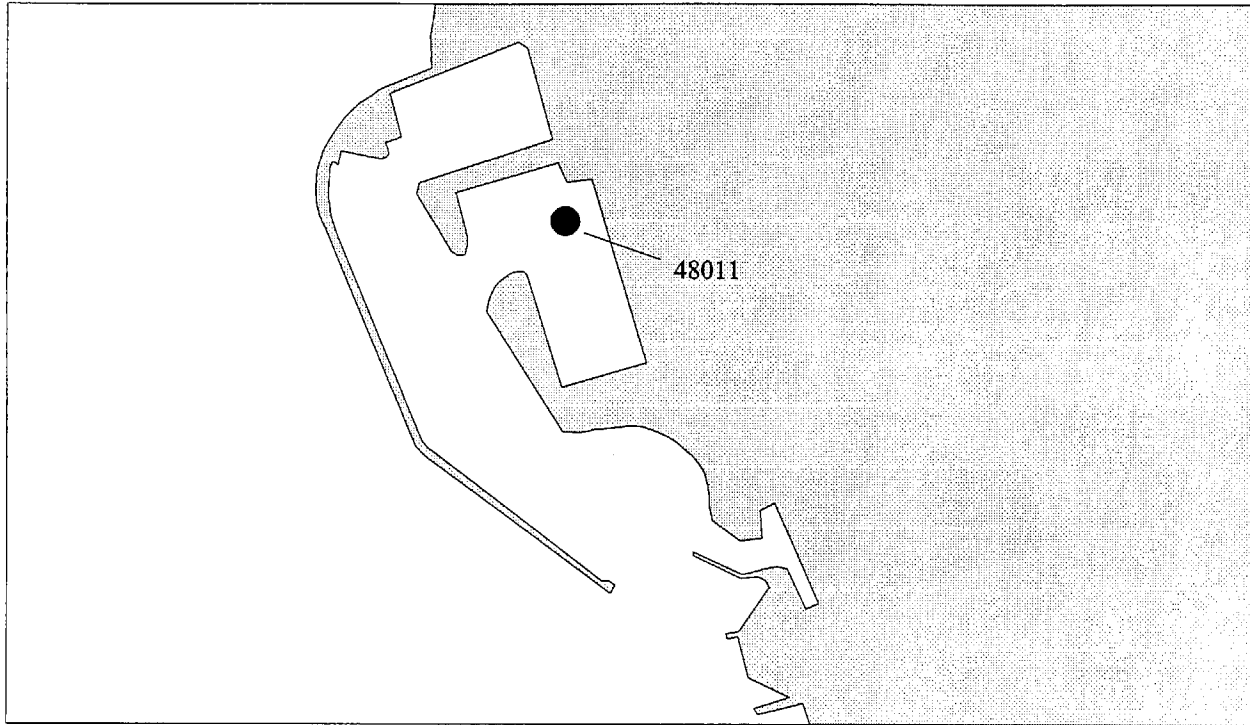


Los Alamitos Bay

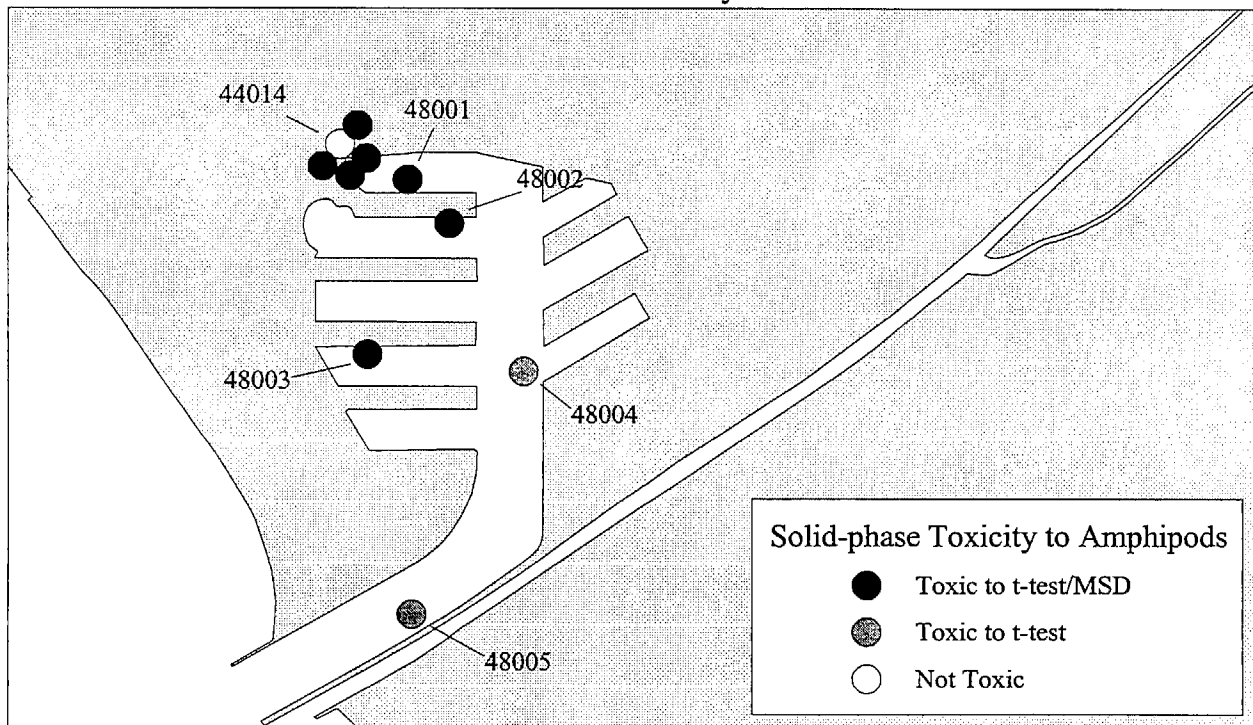


Figures 47a and 47b. Toxicity of Sediment Samples in Shoreline Marina (a), and Los Alamitos Bay (b).

King Harbor

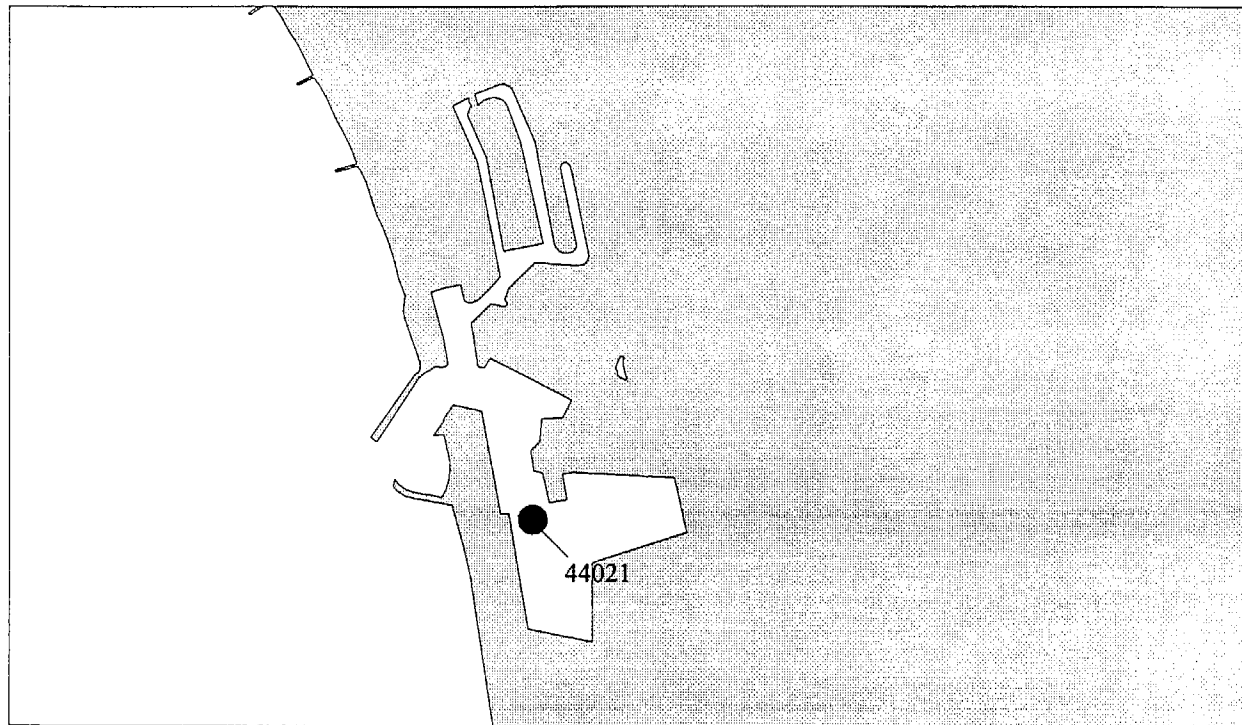


Marina Del Rey

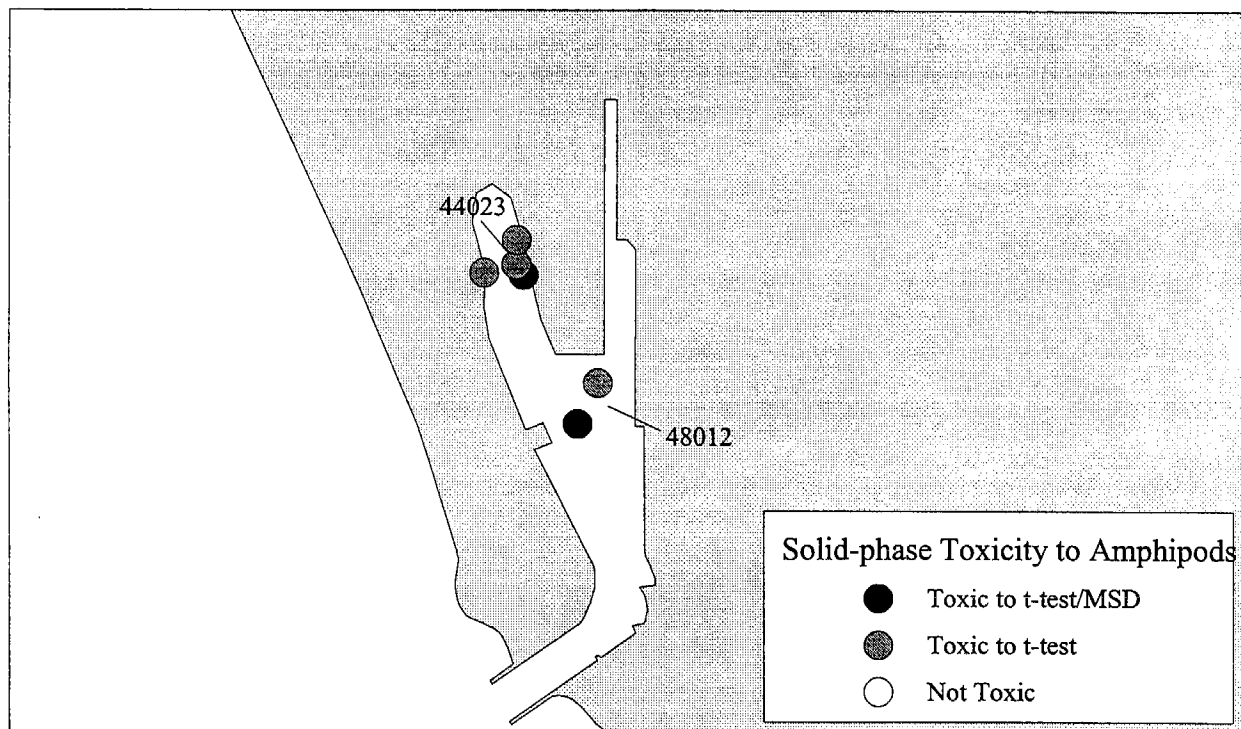


Figures 48a and 48b. Toxicity of Sediment Samples in King Harbor (a), and Marina Del Rey (b).

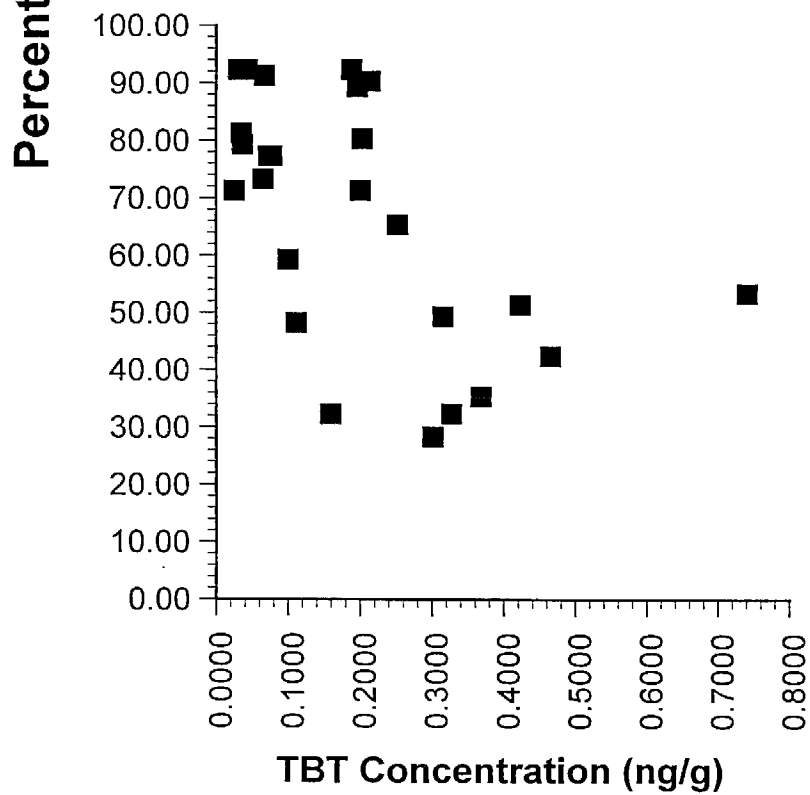
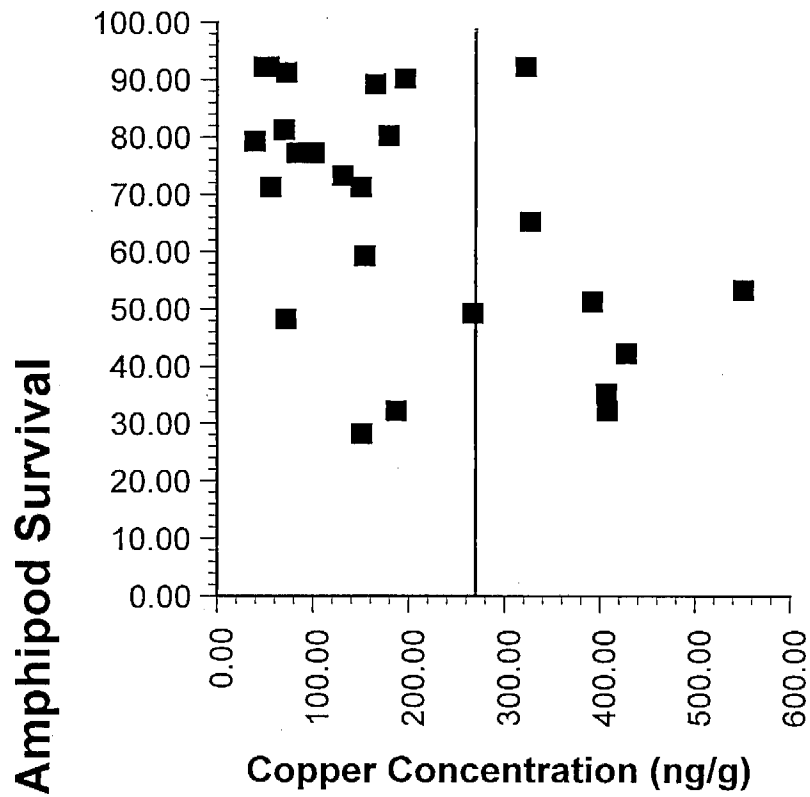
Ventura Marina



Channel Islands Harbor

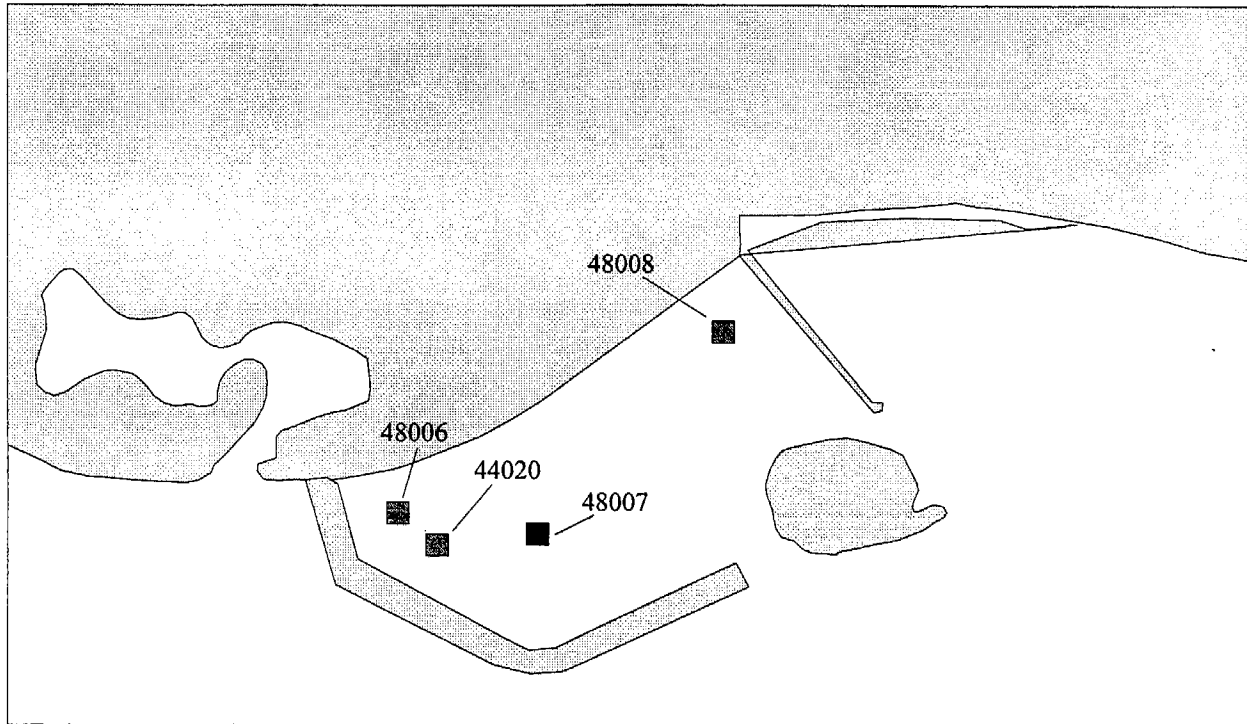


Figures 49a and 49b. Toxicity of Sediment Samples in Ventura Harbor (a), and Channel Islands Harbor (b).

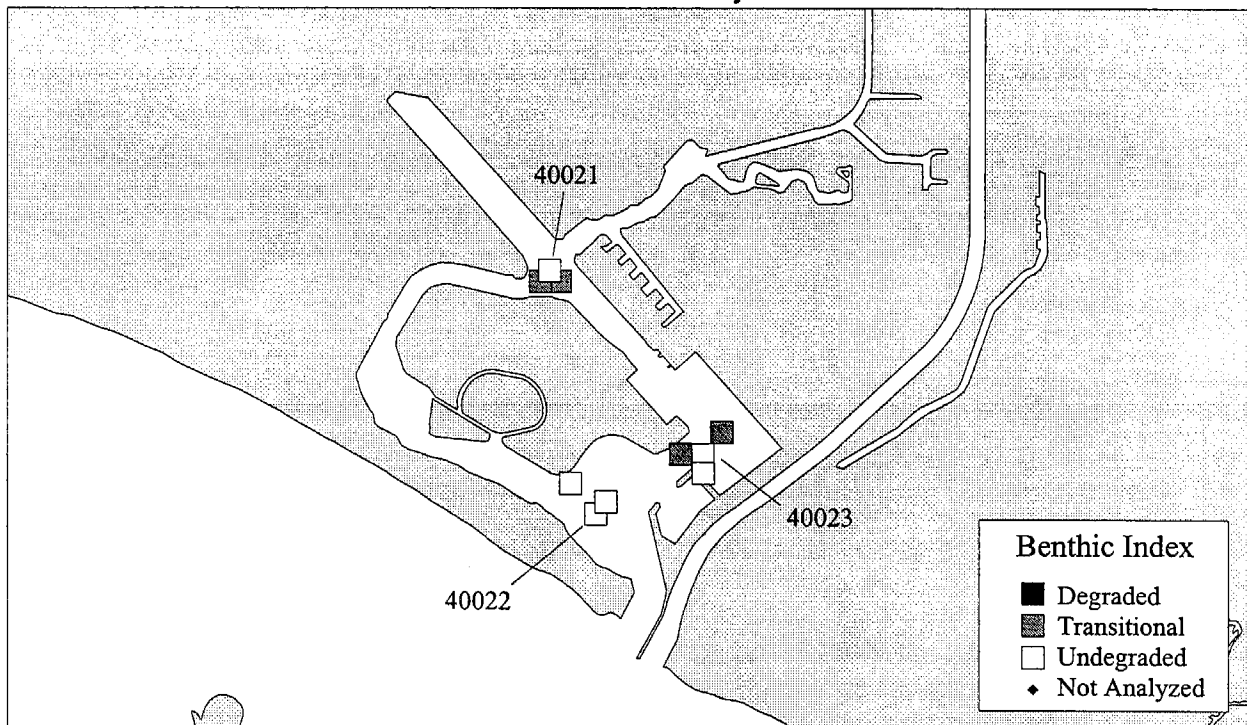


**Figure 50.** Amphipod survival at Marina stations in relation to copper and TBT concentrations. Vertical line indicates ERM value for copper.

Shoreline Marina

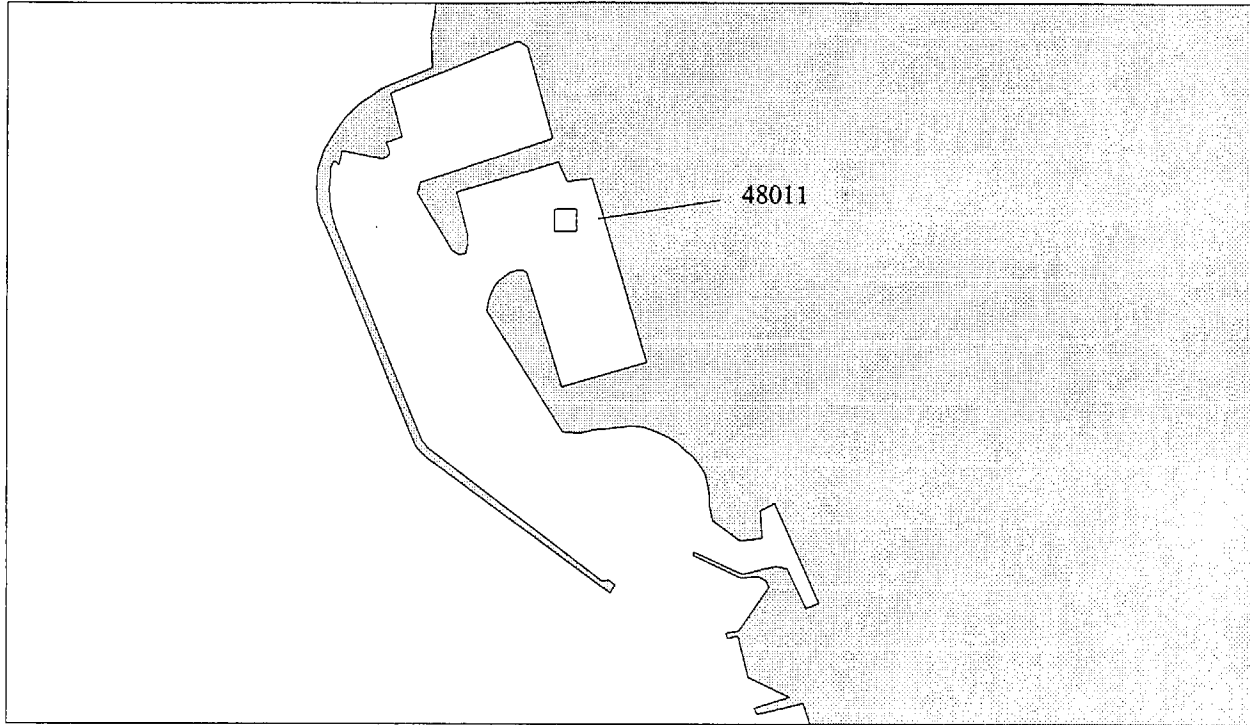


Los Alamitos Bay

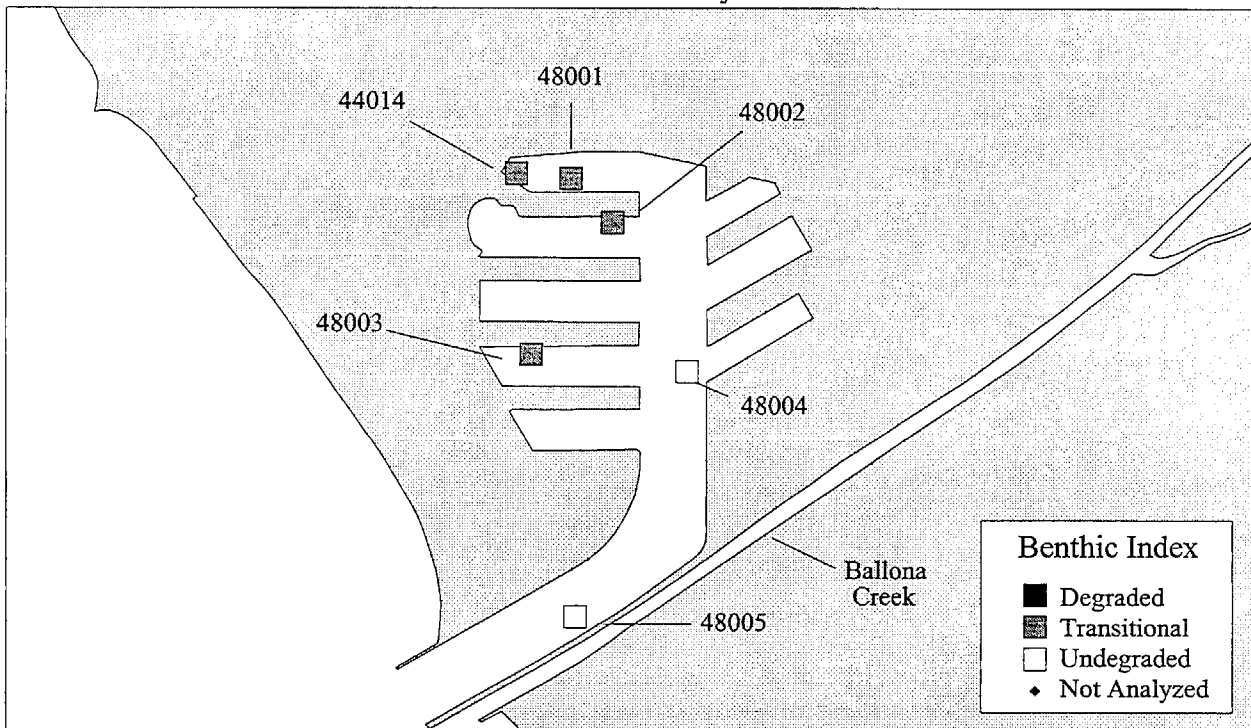


Figures 51a and 51b. Distribution of Stations in Shoreline Marina (a), and Los Alamitos Bay (b), Demonstrating Benthic Community Structure.

### King Harbor



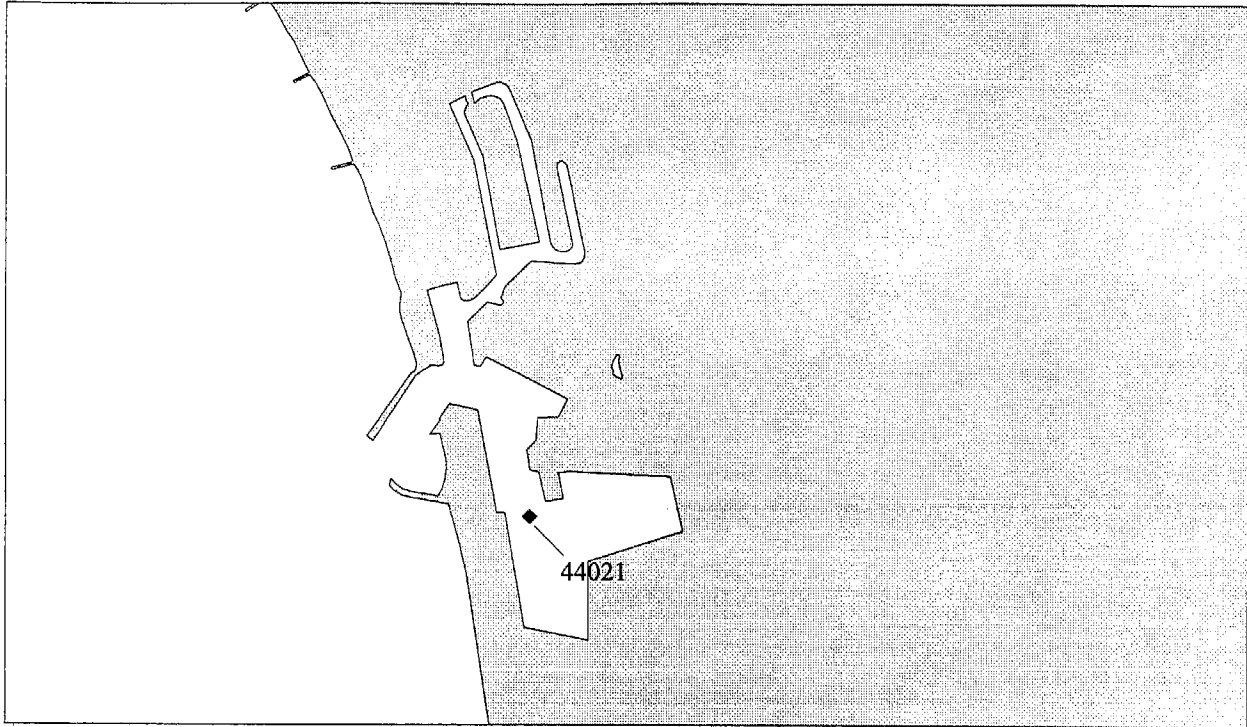
### Marina Del Rey



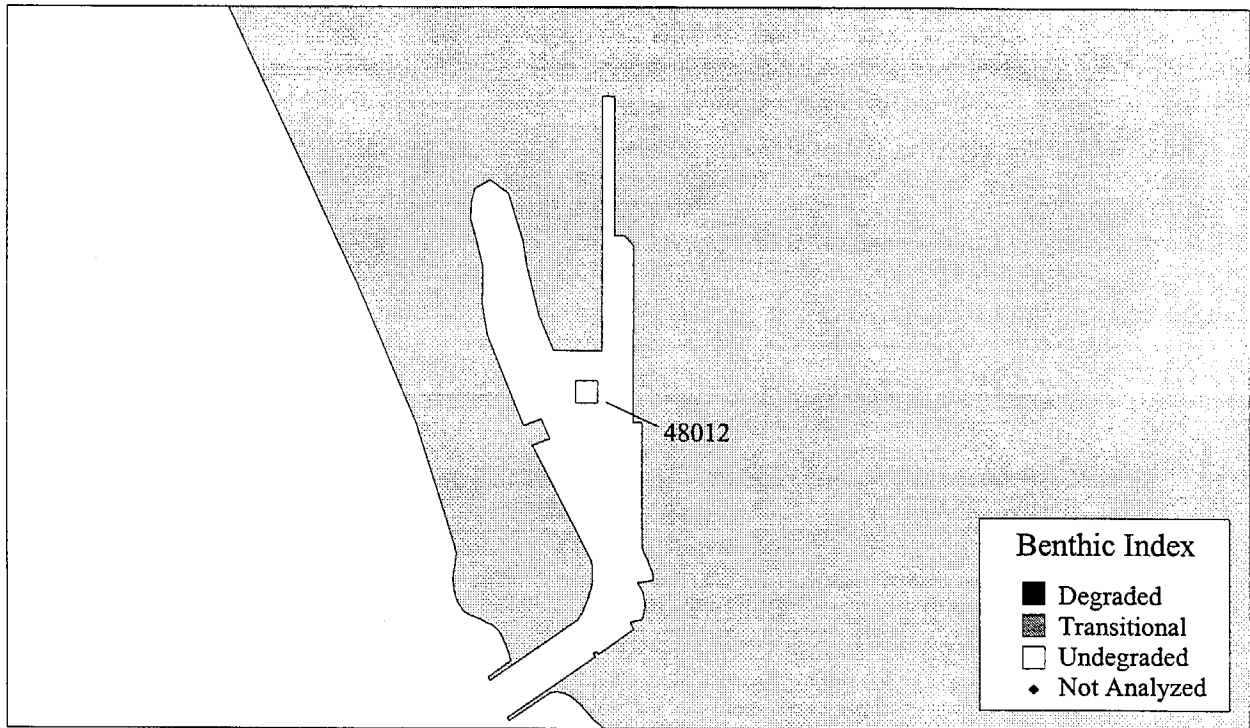
Figures 52a and 52b. Distribution of Stations in King Harbor (a), and Marina Del Rey (b), Demonstrating Benthic Community Structure.



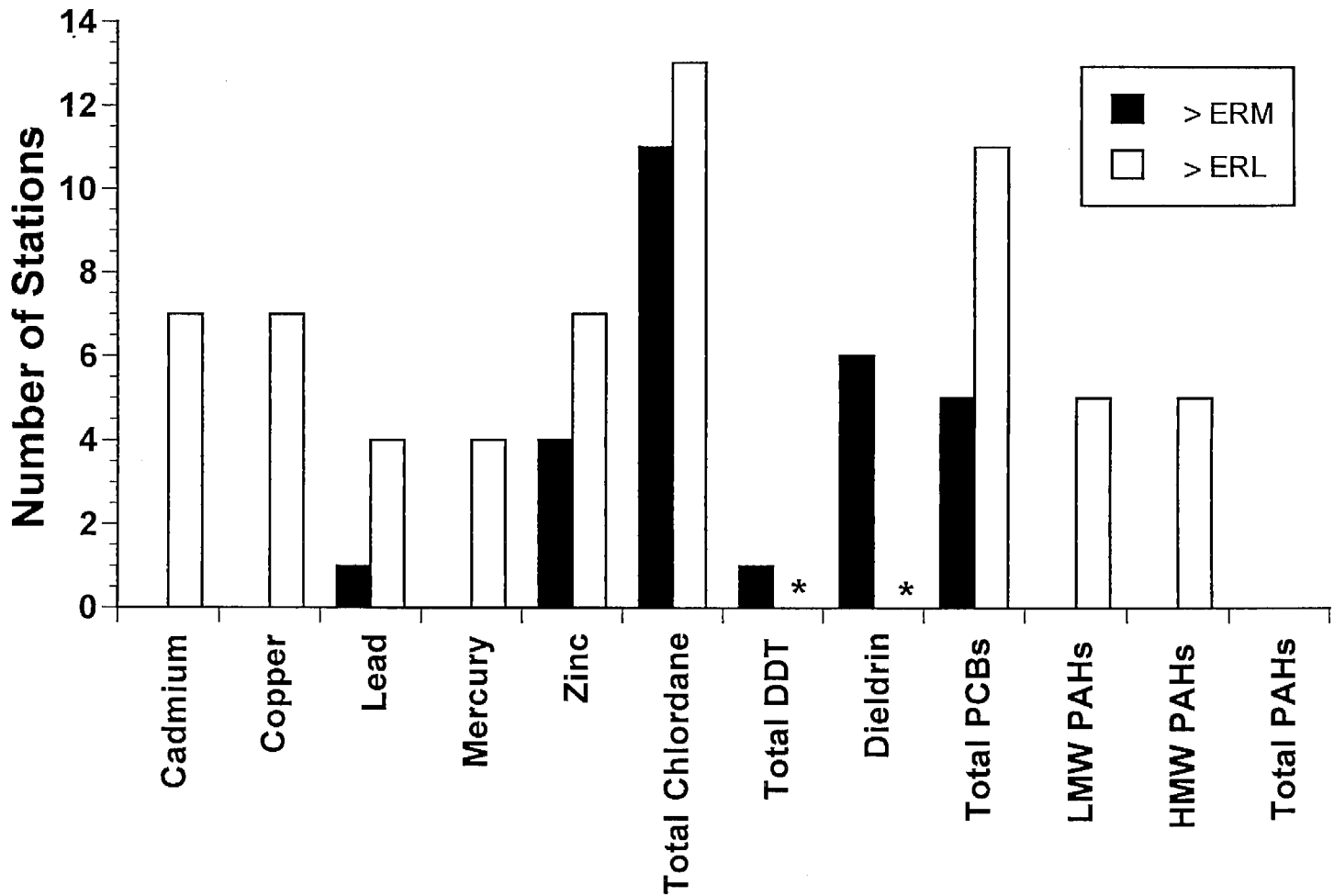
Ventura Marina



Channel Islands Harbor

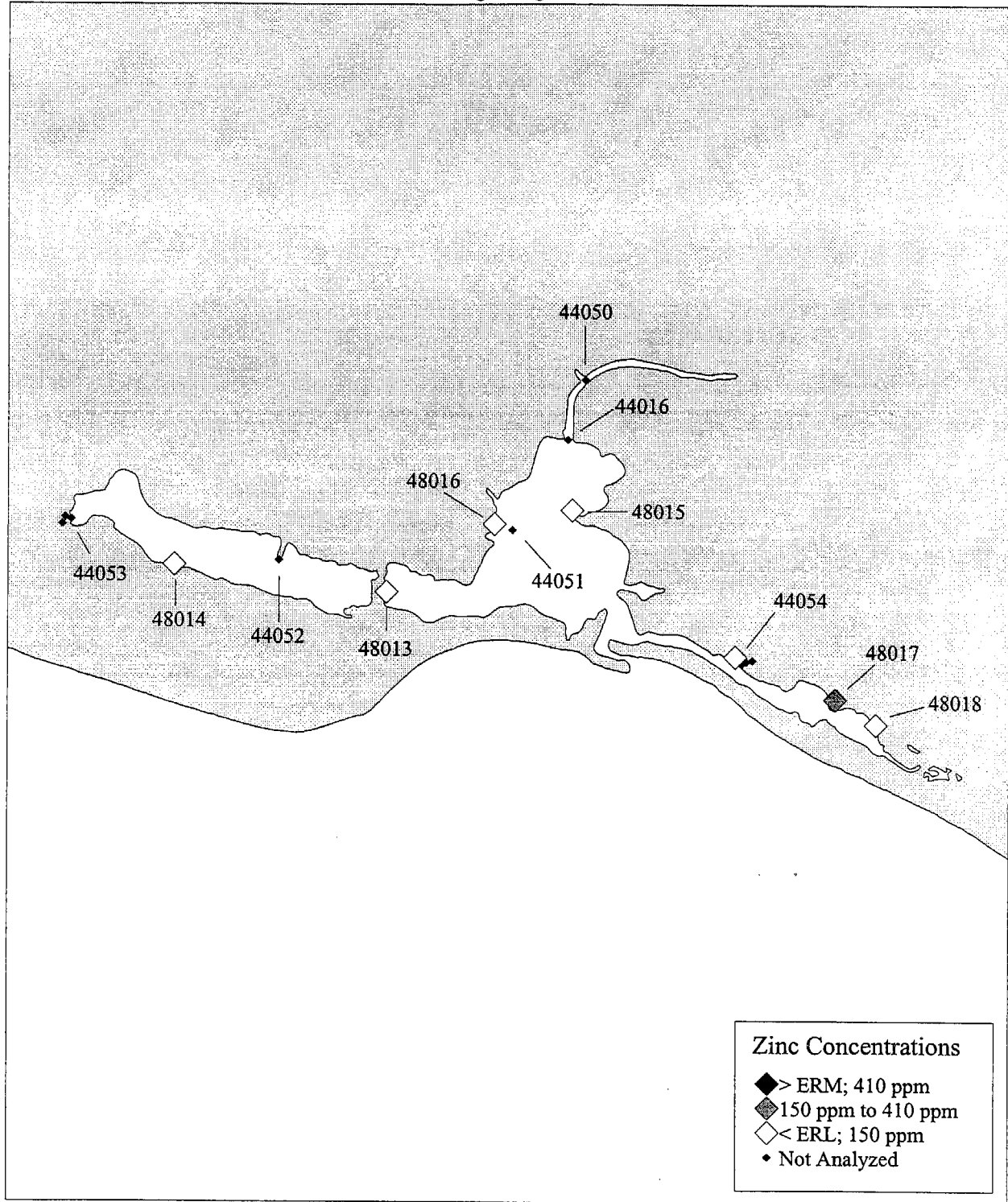


Figures 53a and 53b. Distribution of Stations in Ventura Harbor (a), and Channel Islands Harbor (b), Demonstrating Benthic Community Structure.



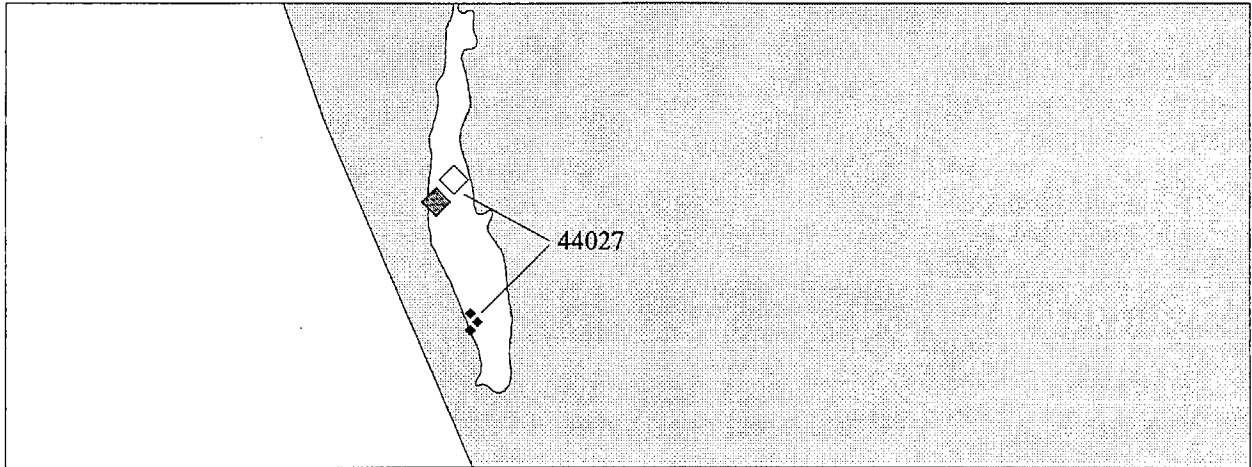
**Figure 54 .** Number of Lagoon station samples exceeding either the ERM or ERL sediment quality guidelines. (Total DDT was compared to the Swartz *et al.* sediment effect concentration, 100 ug/g OC. \* no ERL exceedances were calculated for Total DDT or Dieldrin; see text for details).

# Mugu Lagoon

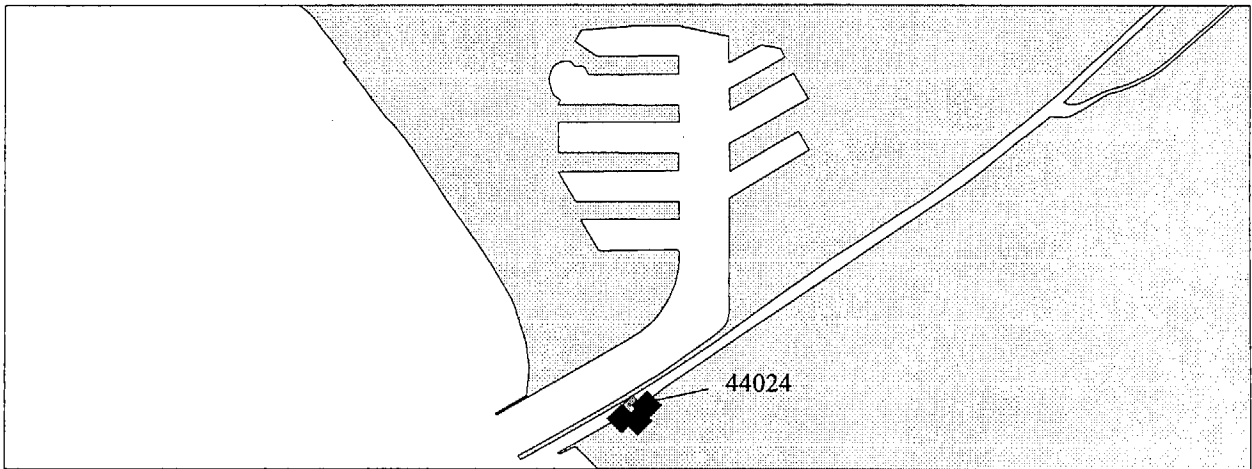


Figures 55. Distribution of samples in Mugu Lagoon exceeding the ERM for Zinc.

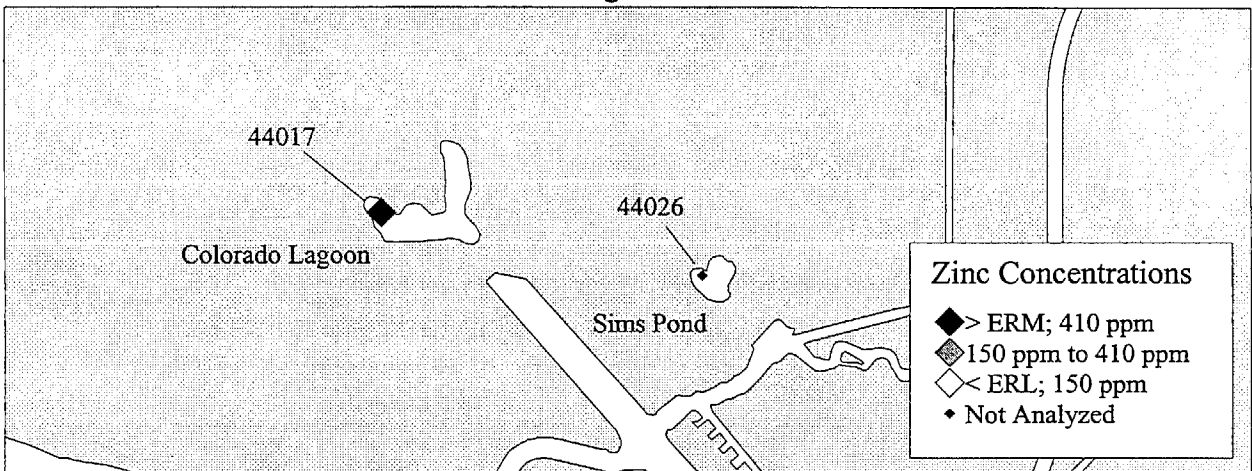
McGrath Lake



Ballona Creek



Colorado Lagoon/Sims Pond



Figures 56a, 56b, and 56c. Distribution of samples in McGrath Lake (a), Ballona Creek (b), and Colorado Lagoon/Sims Pond (c), exceeding the ERM for Zinc.

# Mugu Lagoon

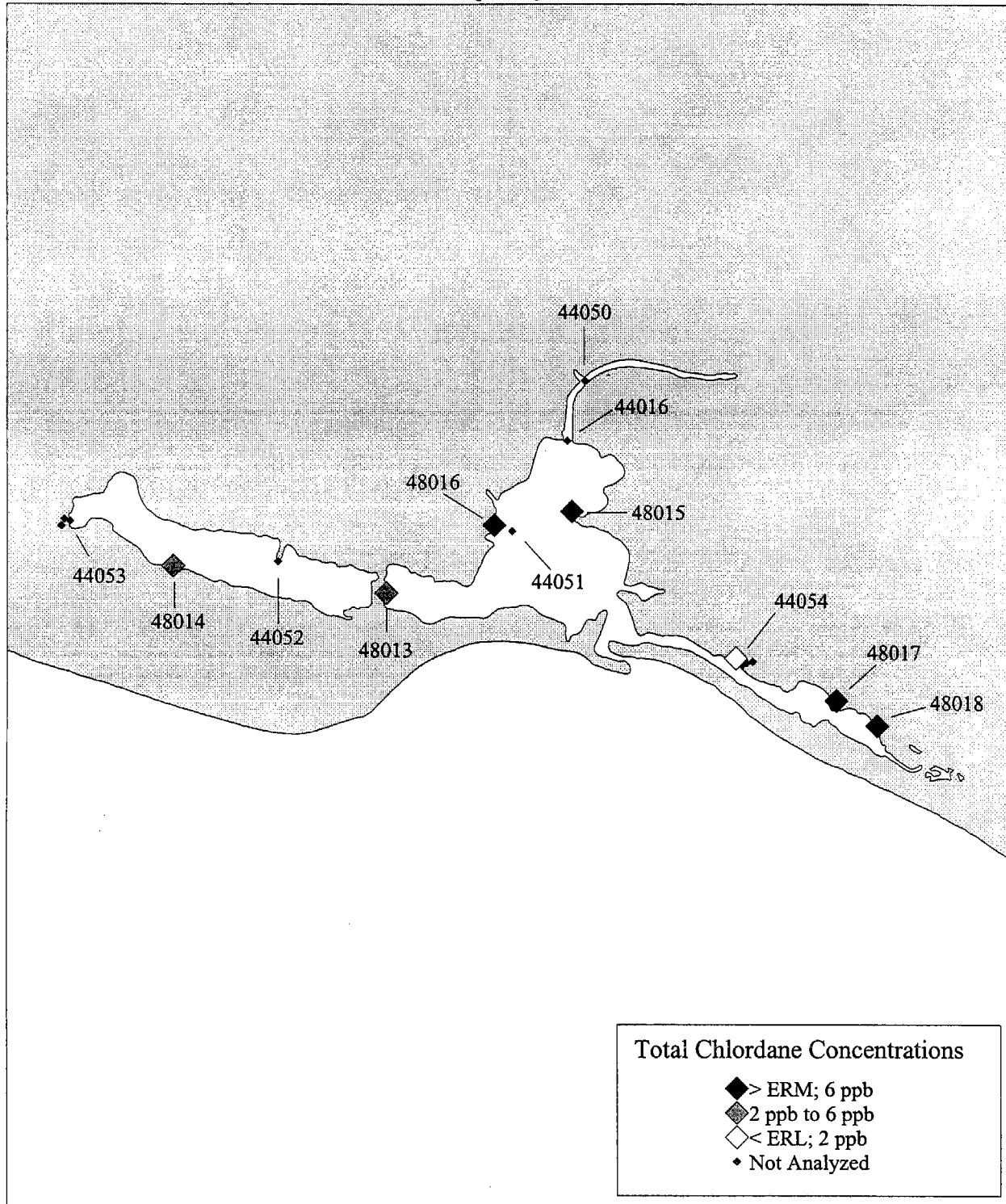
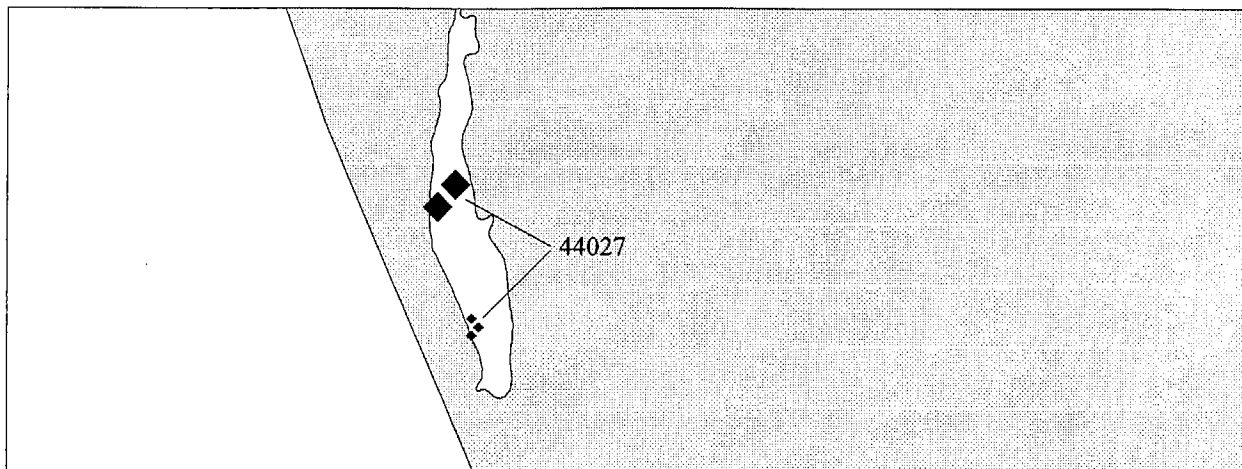
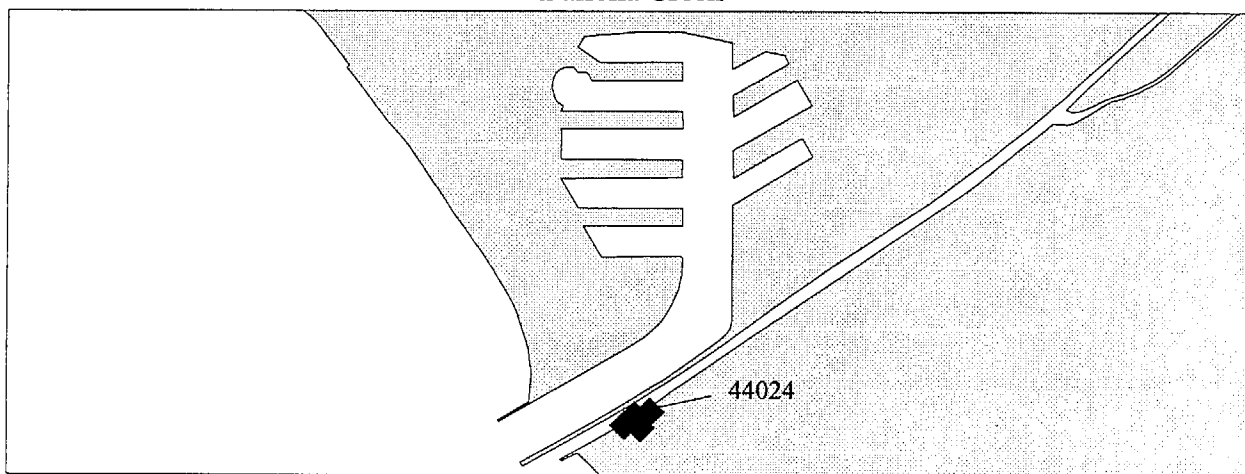


Figure 57. Distribution of samples in Mugu Lagoon exceeding the ERM for Total Chlordane.

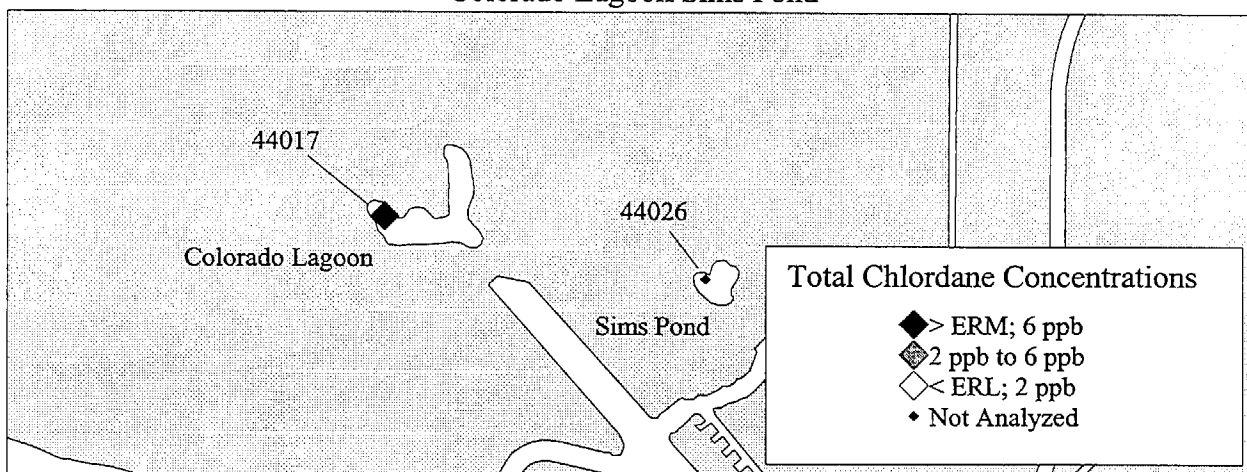
McGrath Lake



Ballona Creek



Colorado Lagoon/Sims Pond



Figures 58a, 58b, and 58c. Distribution of samples in McGrath Lake (a), Ballona Creek (b), and Colorado Lagoon/Sims Pond (c), exceeding the ERM for Total Chlordane.

# Mugu Lagoon

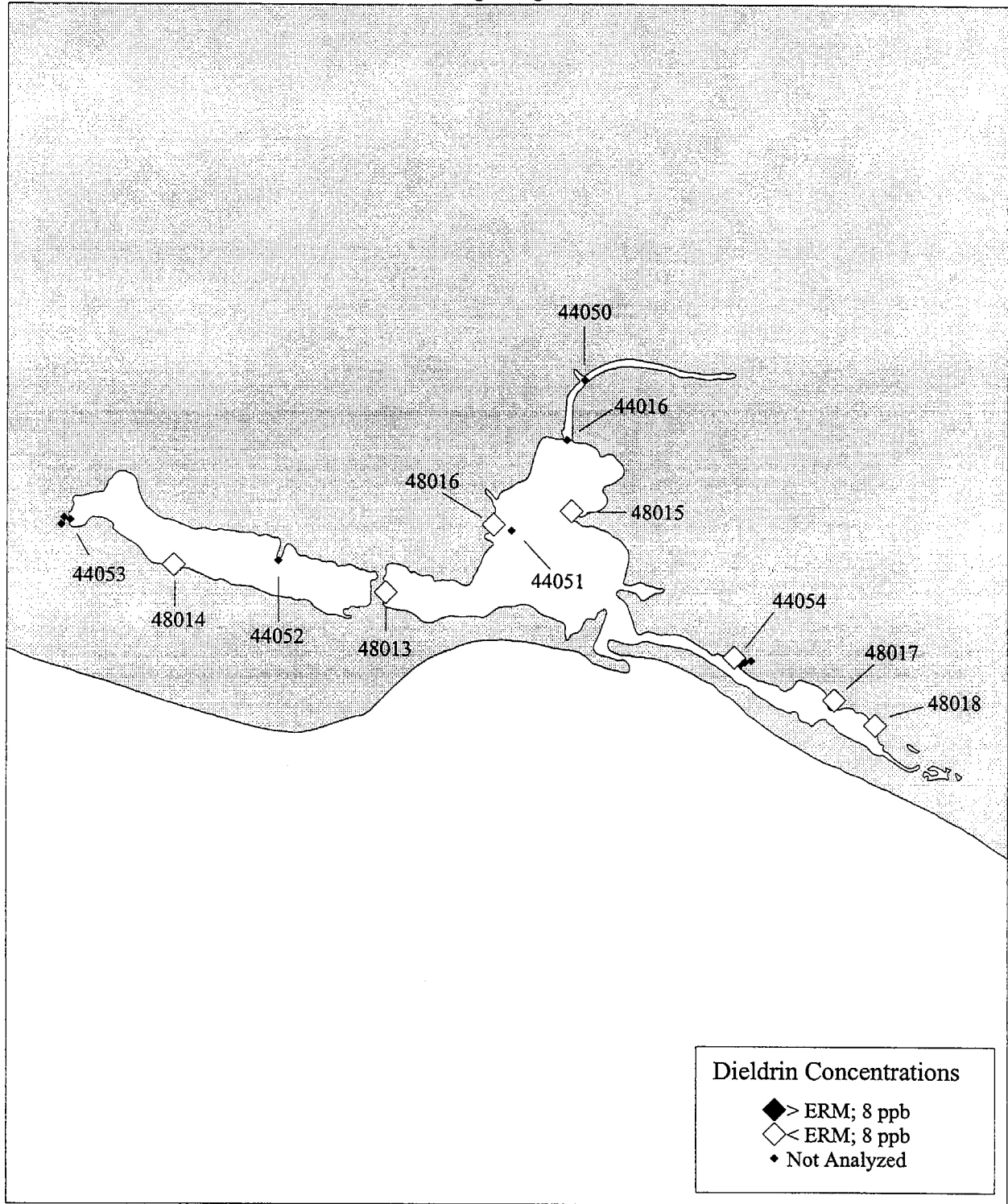
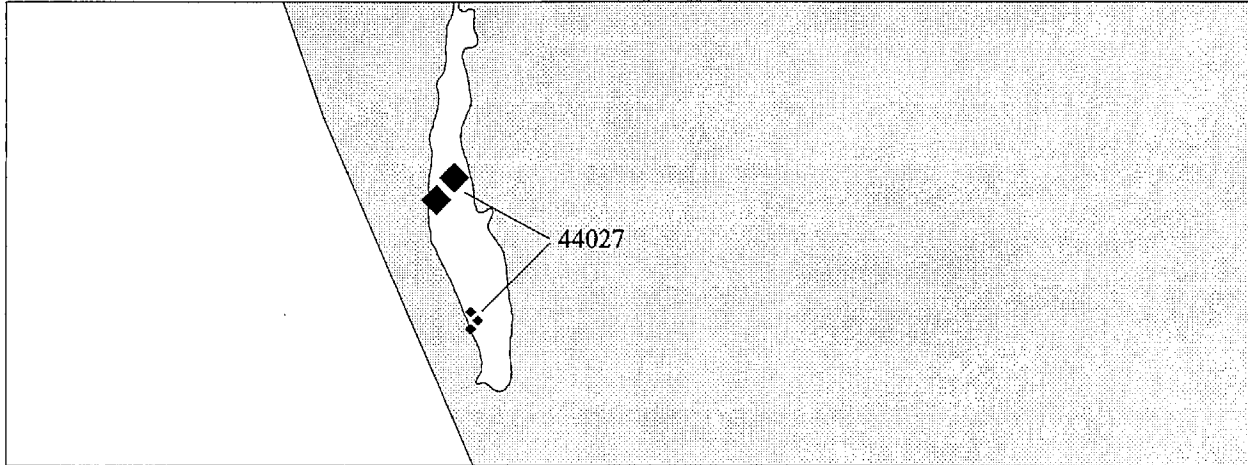
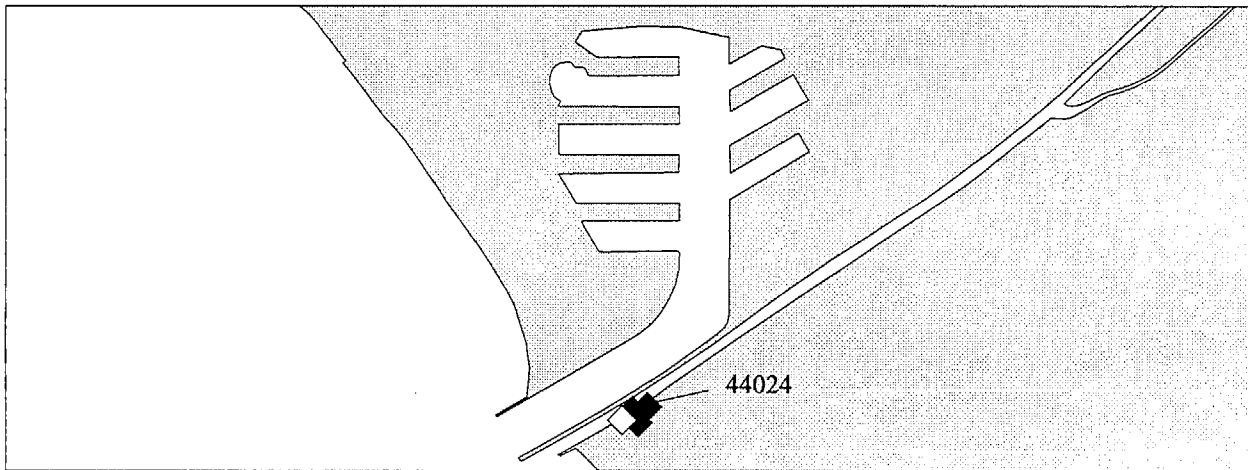


Figure 59. Distribution of samples in Mugu Lagoon exceeding the ERM for Dieldrin.

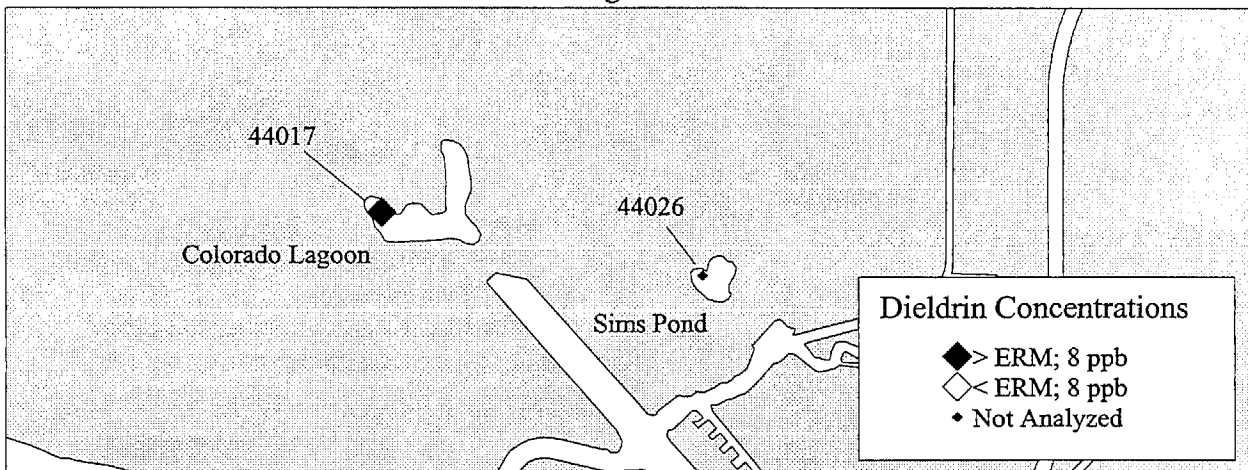
McGrath Lake



Ballona Creek



Colorado Lagoon/Sims Pond



Figures 60a, 60b, and 60c. Distribution of samples in McGrath Lake (a), Ballona Creek (b), and Colorado Lagoon/Sims Pond (c), exceeding the ERM for Dieldrin.



# Mugu Lagoon

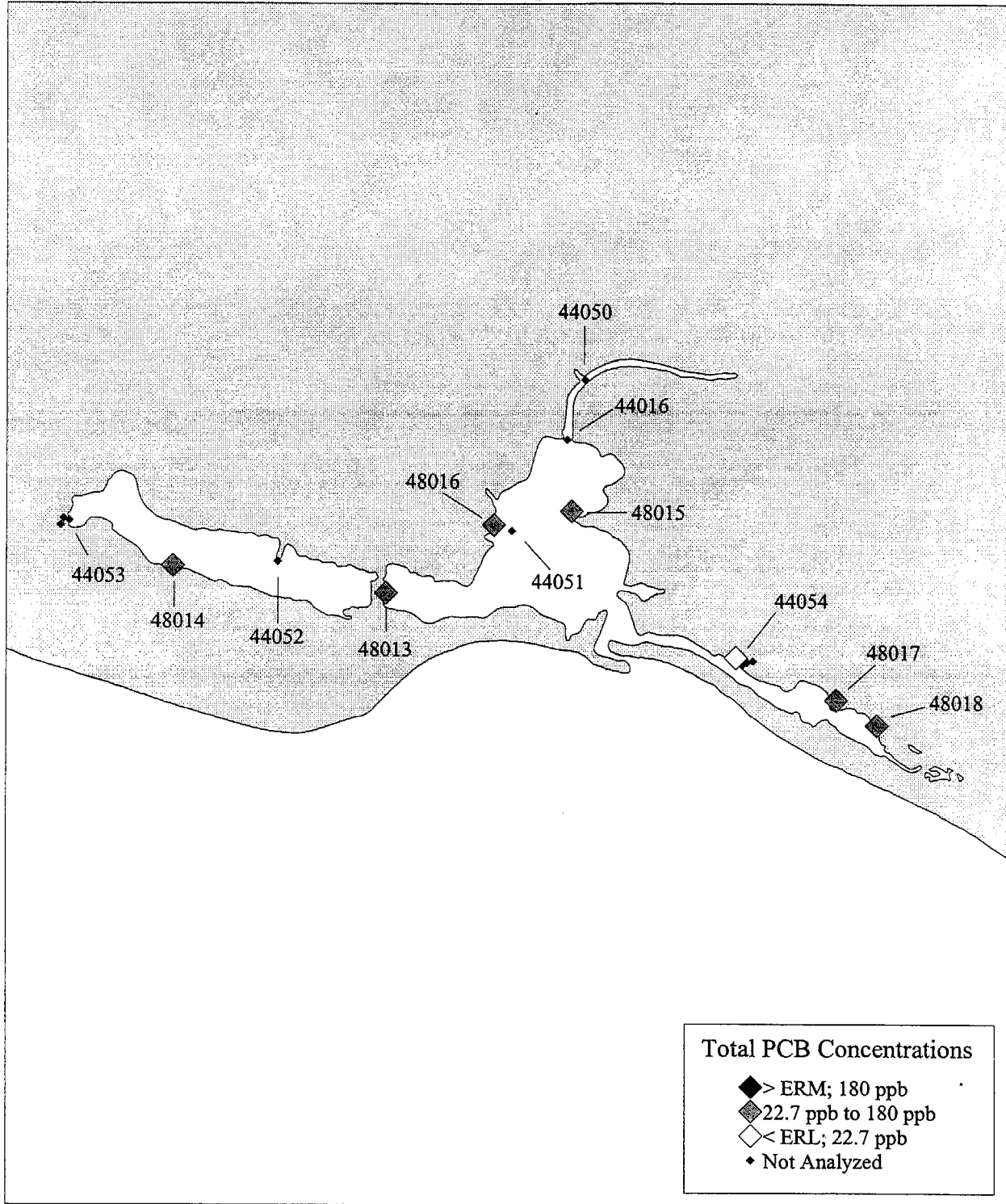
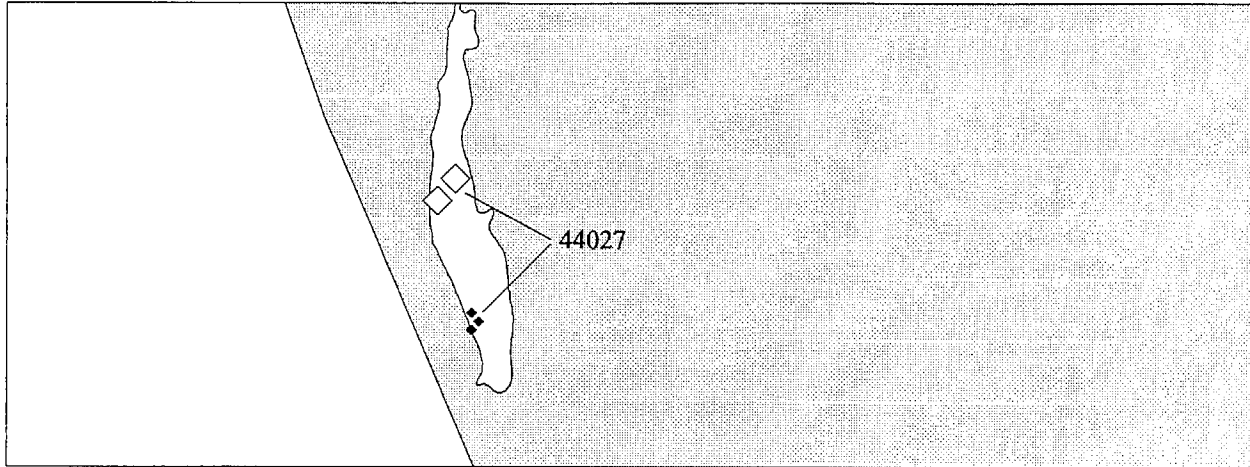
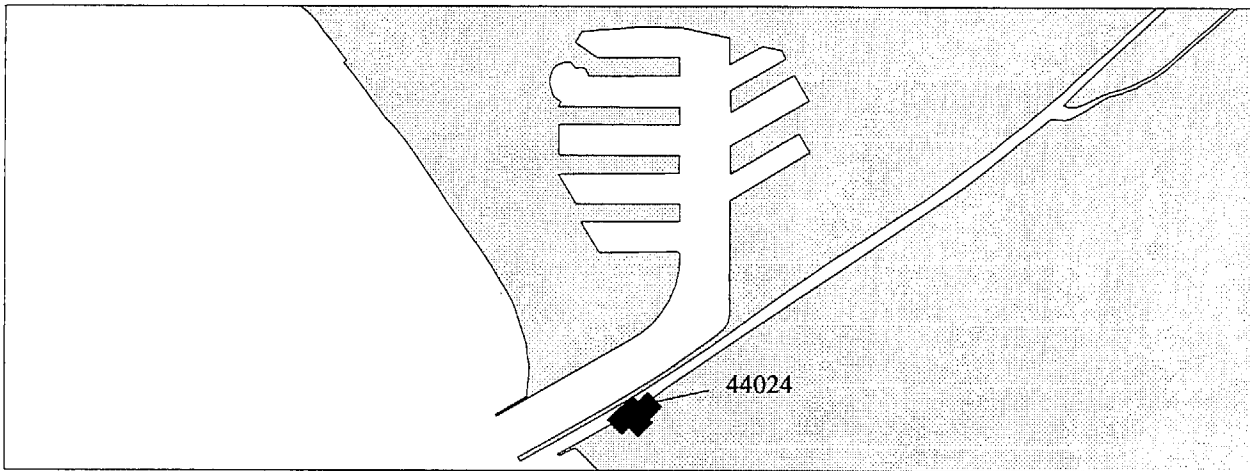


Figure 61. Distribution of samples in Mugu Lagoon exceeding the ERM for Total PCB.

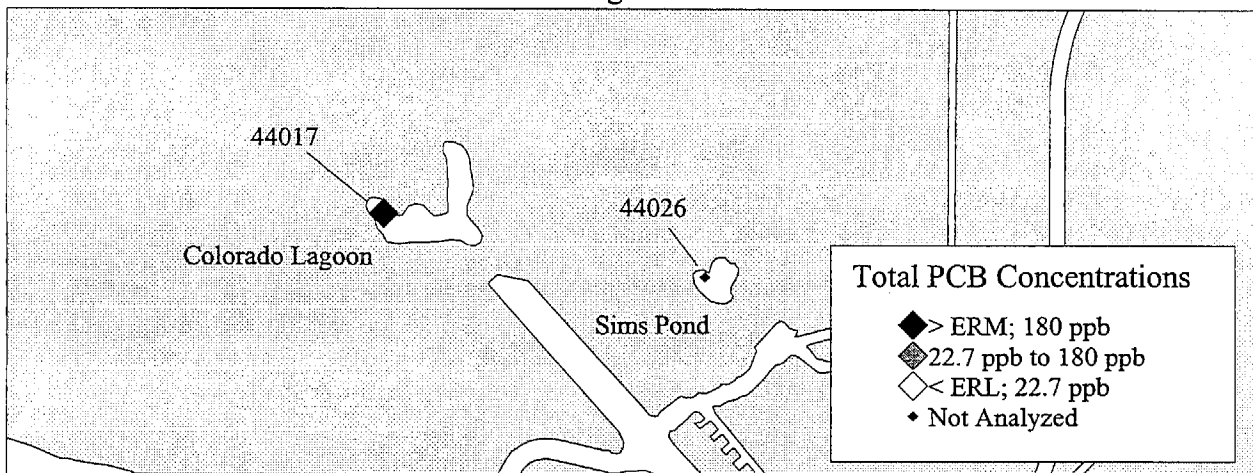
McGrath Lake



Ballona Creek



Colorado Lagoon/Sims Pond



Figures 62a, 62b, and 62c. Distribution of samples in McGrath Lake (a), Ballona Creek (b), and Colorado Lagoon/Sims Pond (c), exceeding the ERM for Total PCB.

# Mugu Lagoon

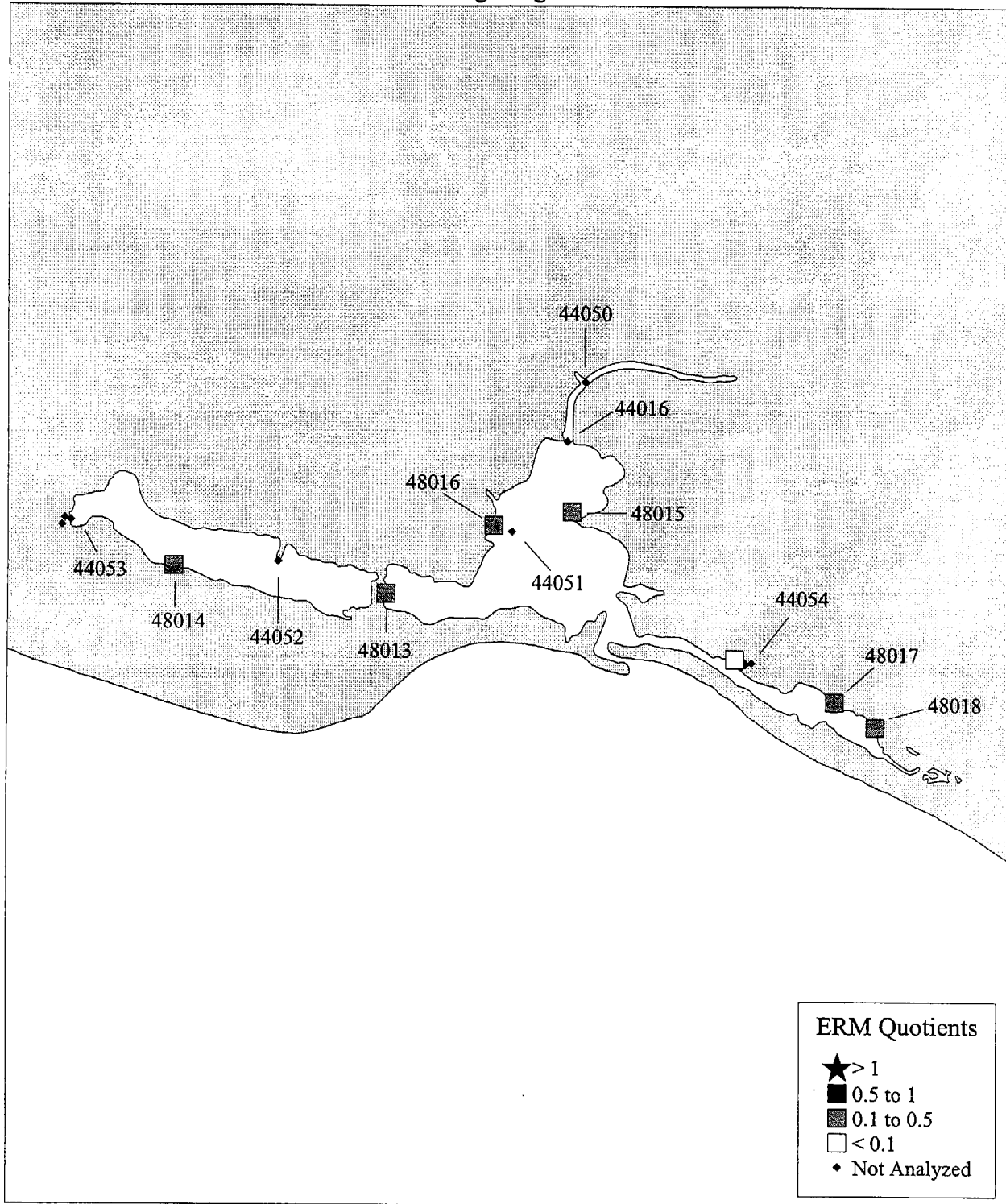
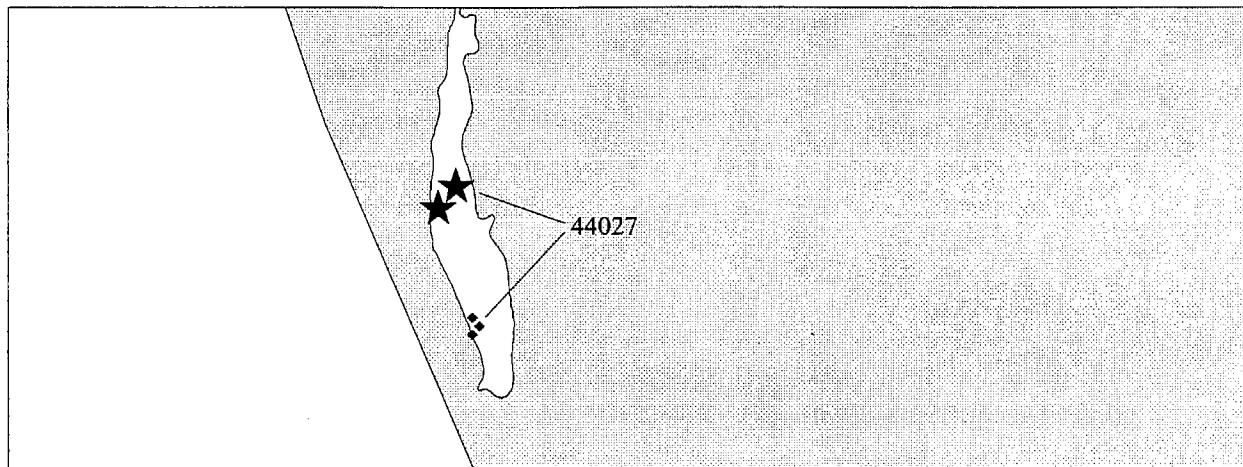
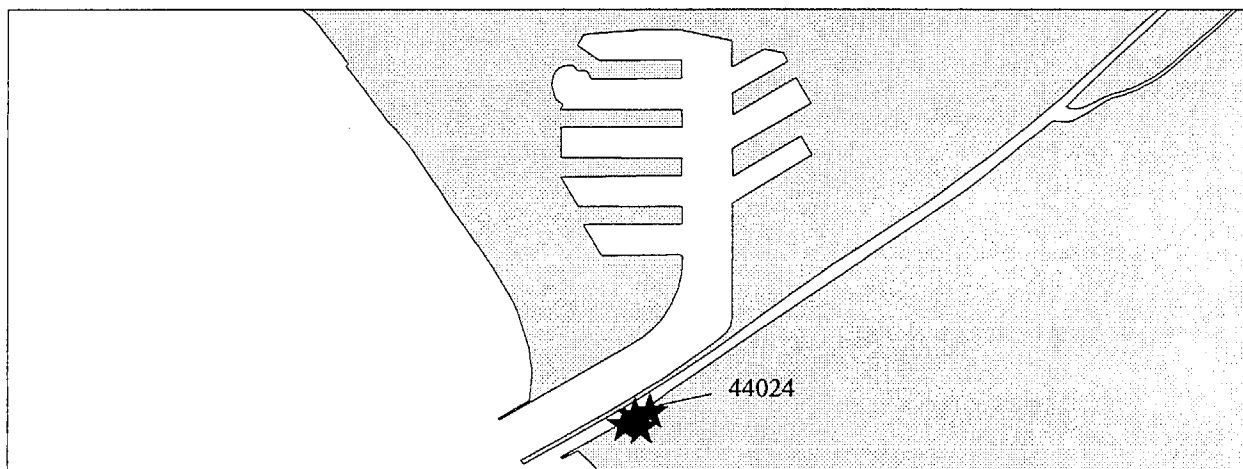


Figure 63. ERM values at Mugu Lagoon Sampling Stations.

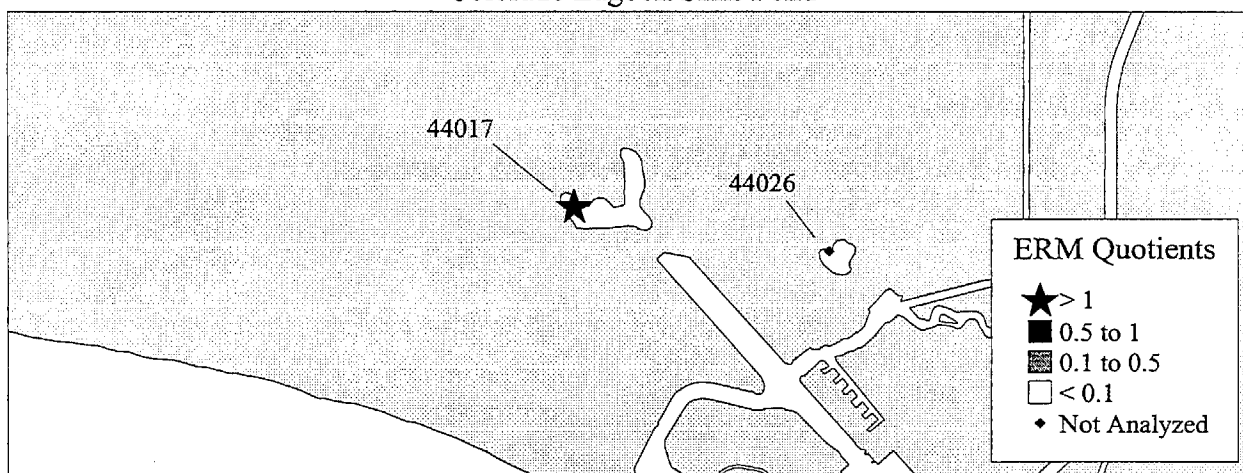
McGrath Lake



Ballona Creek



Colorado Lagoon/Sims Pond



Figures 64a, 64b, and 64c. ERM values at McGrath Lake (a), Ballona Creek (b), and Colorado Lagoon/Sims Pond (c), Sampling Stations.

# Mugu Lagoon

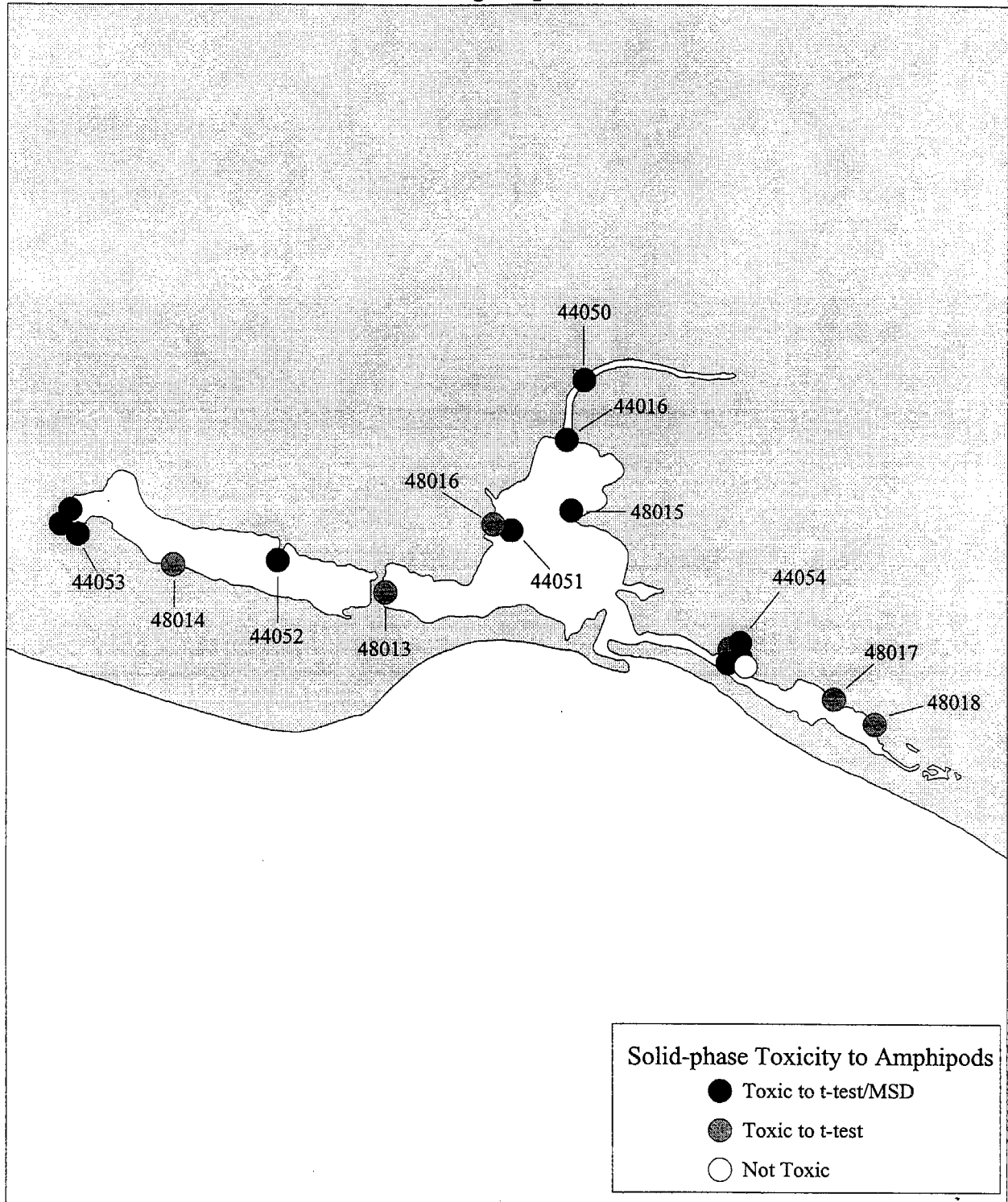
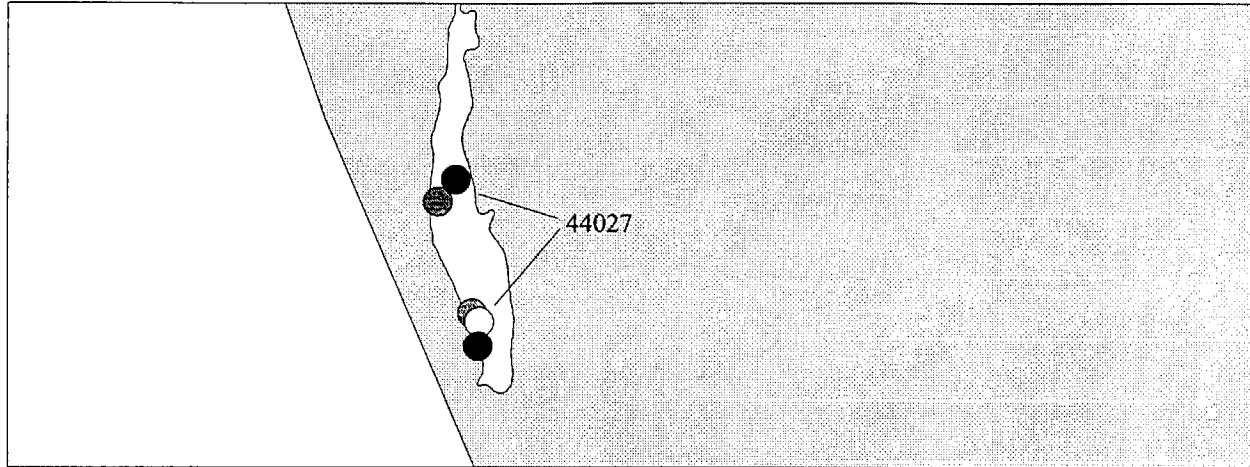
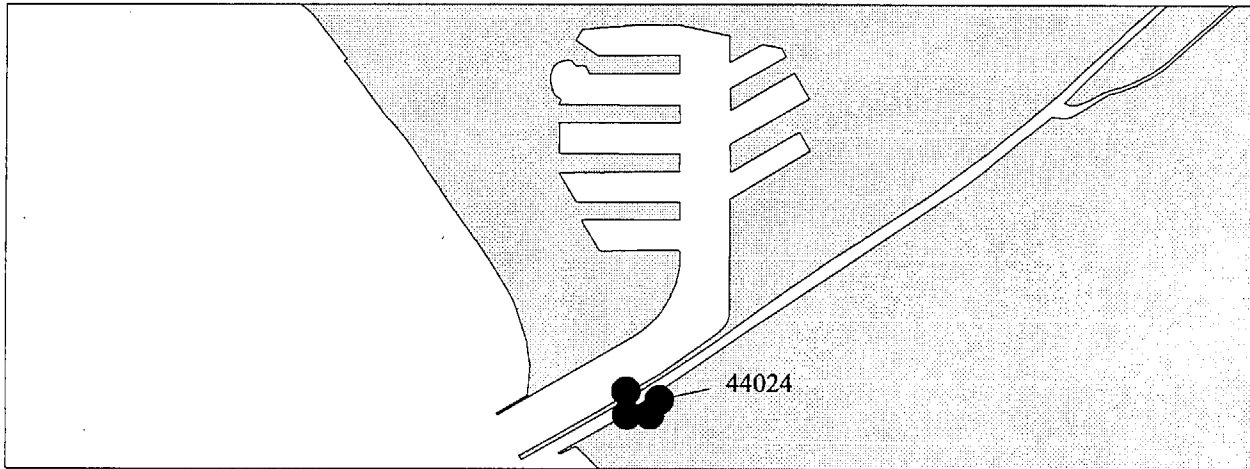


Figure 65. Toxicity of Sediment Samples in Mugu Lagoon.

McGrath Lake



Ballona Creek



Colorado Lagoon/Sims Pond

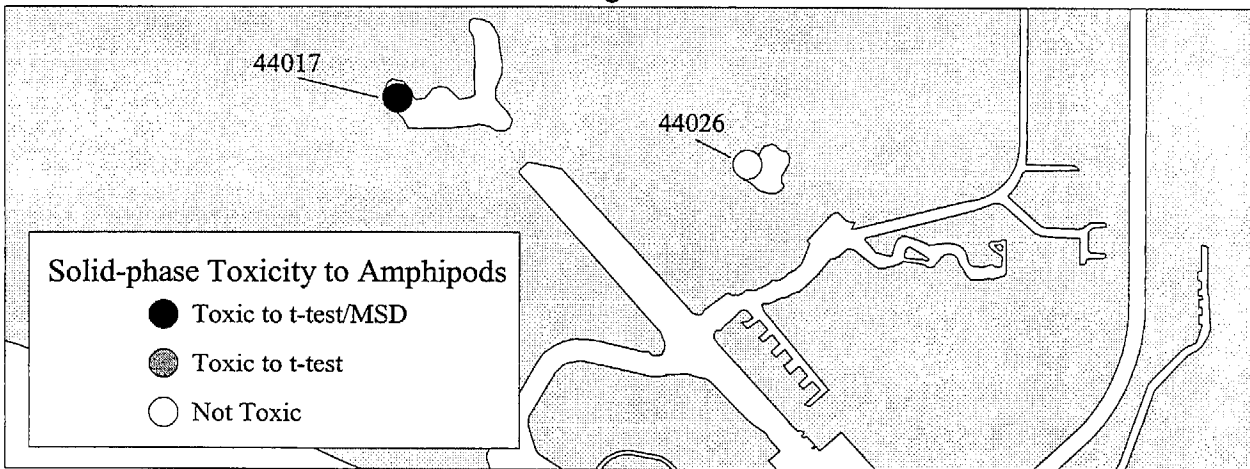
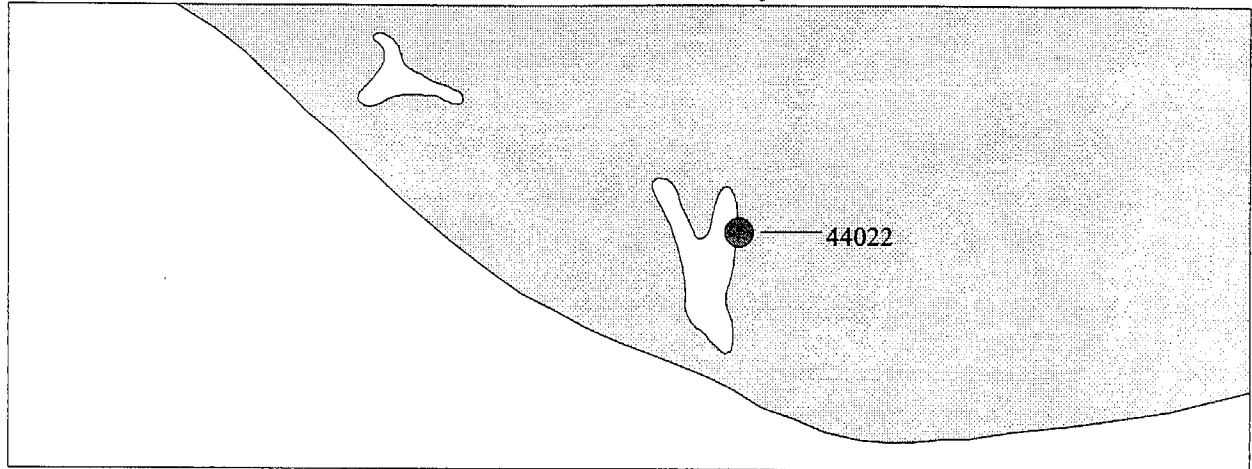
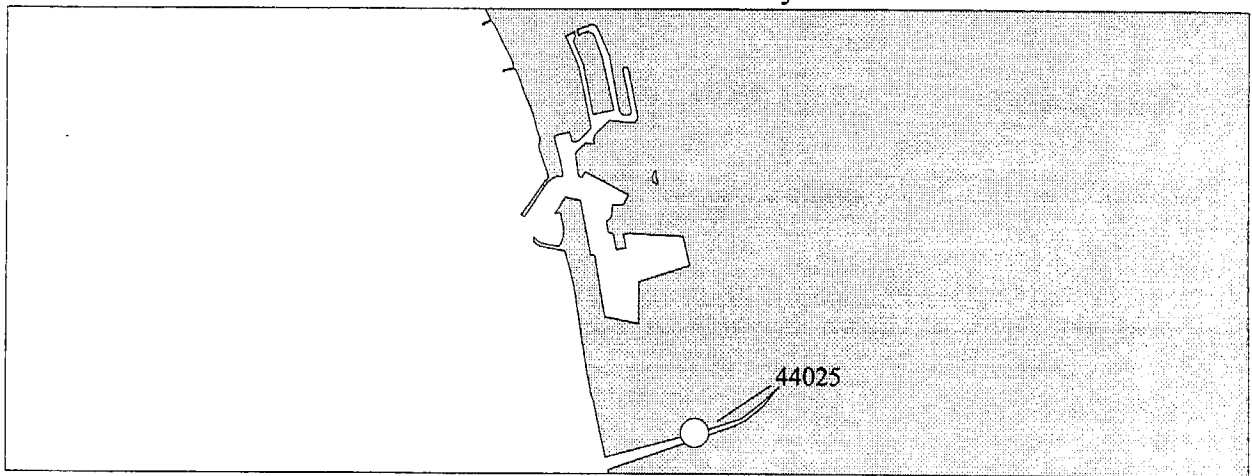


Figure 66a, 66b, and 66c. Toxicity of Sediment Samples in McGrath Lake (a), Ballona Creek (b), and Colorado Lagoon/Sims Pond (c).

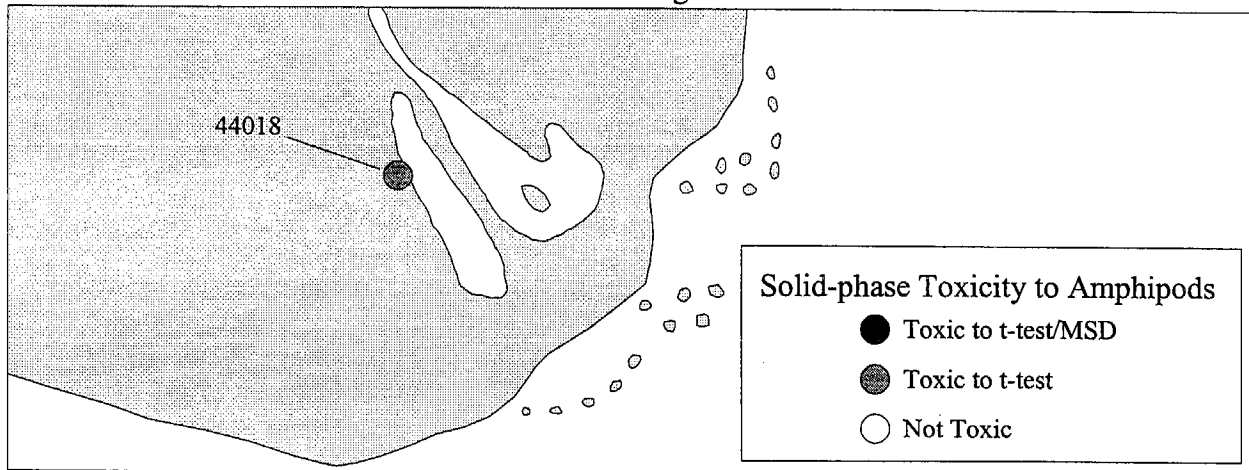
Ventura River Estuary



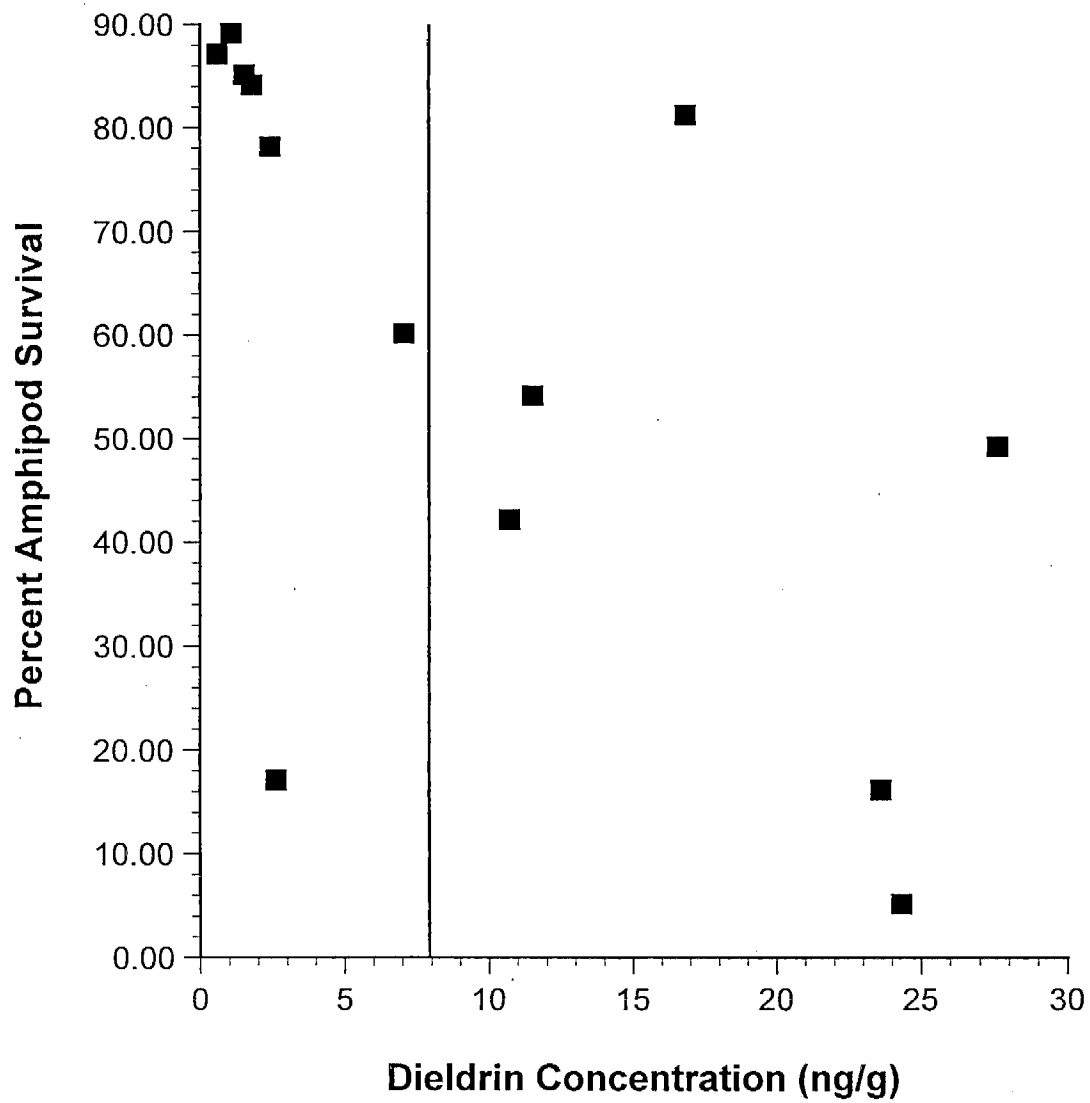
Santa Clara River Estuary



Malibu Lagoon

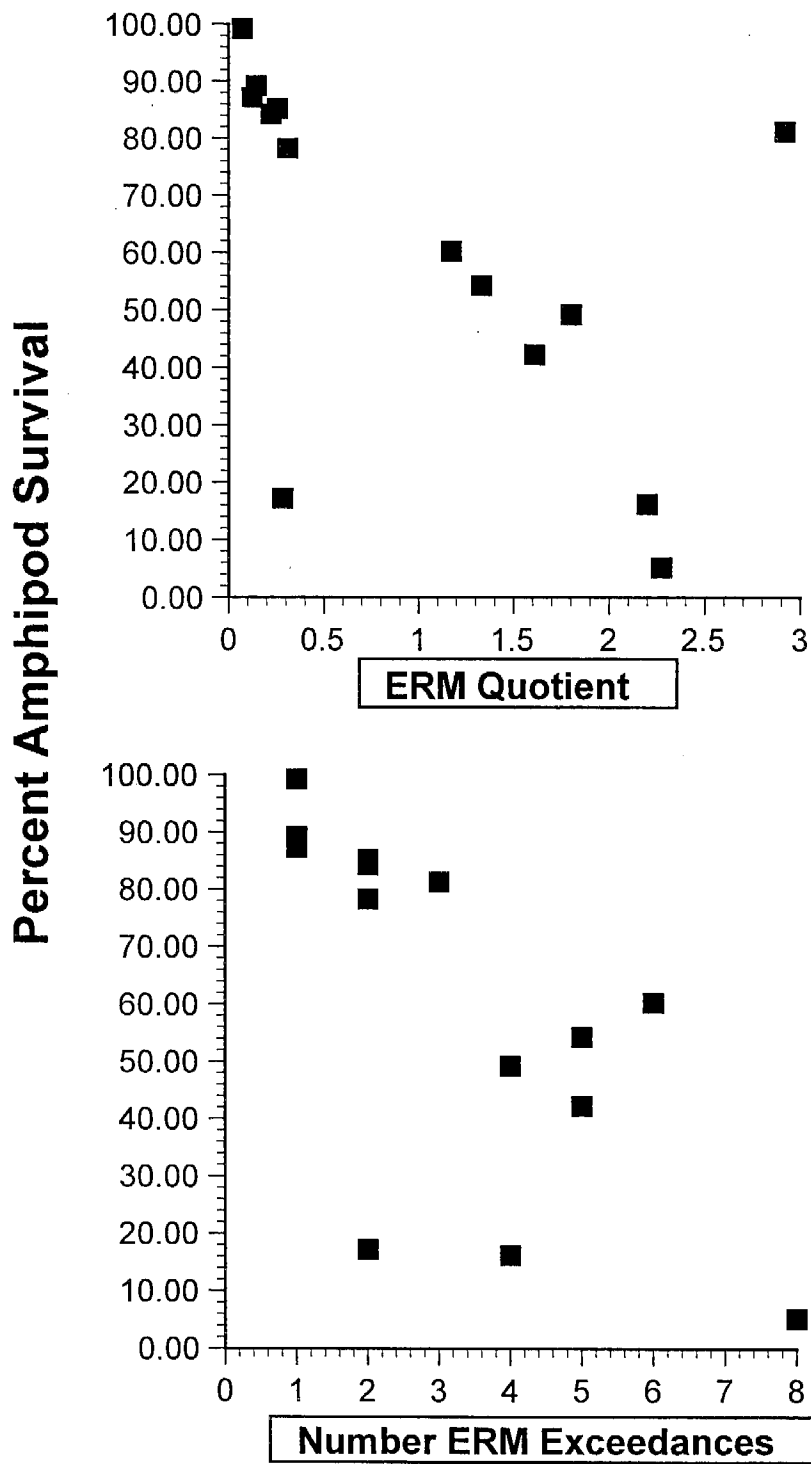


Figures 67a, 67b, and 67c. Toxicity of Sediment Samples in Ventura River Estuary (a), Santa Clara River Estuary (b), and Malibu Lagoon (c).



**Figure 68.** Amphipod survival at Lagoon stations in relation to Dieldrin concentrations. Vertical line indicates ERM guideline value.





**Figure 69 .** Amphipod survival at Lagoon stations in relation to average ERM Quotient and Number of ERM Exceedances.

# Mugu Lagoon

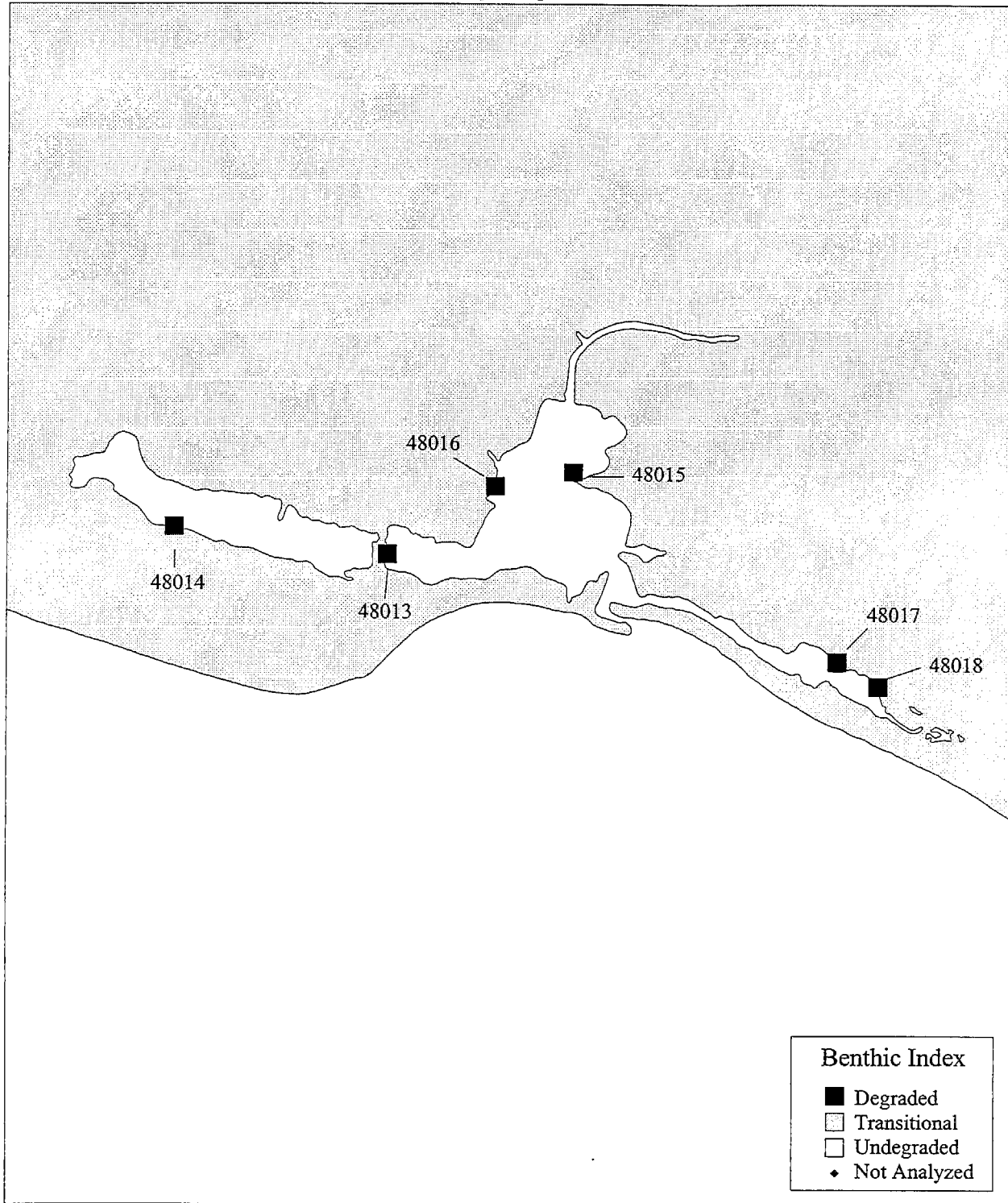


Figure 70. Distribution of Stations in Mugu Lagoon Demonstrating Benthic Community Structure.