

**CALIFORNIA REGIONAL WATER QUALITY CONTROL BOARD
SAN FRANCISCO BAY REGION**

ORDER No. R2-2015-0005

**WASTE DISCHARGE REQUIREMENTS and WATER QUALITY CERTIFICATION for:
ZARSION-OHP 1, LLC
OAK TO NINTH AVENUE PROJECT
OAKLAND, ALAMEDA COUNTY**

The California Regional Water Quality Control Board, San Francisco Bay Region (hereinafter the Regional Water Board), finds that:

1. Zarsion-OHP 1, LLC, (Discharger) has applied to the Regional Water Board for authorization to construct a mixed-use project consisting of a multi-family, urban residential neighborhood with a retail component (Project) on the 64-acre Oak to Ninth Avenue Project Site (Project Site), located along the Oakland Estuary and the Embarcadero, east of Jack London Square and south of Interstate 880 (Approximate Latitude and Longitude: N 27°47'15" E 122°12'30"; See Figure 1. *Regional Location Map*, and Figure 2. *Project Location Map*, in Attachment 1 to this Order) in the City of Oakland. About 33 acres of the Project Site will be developed with park and open space, including the existing Estuary Park and Aquatic Center west of the Lake Merritt Channel, and about 24 acres of the Project Site will be developed with about 3,100 residential dwelling units and 200,000 square feet of ground floor retail/commercial space. New public streets, with a total surface area of about 9 acres, will be constructed to provide access to the Project Site.
2. The Project Site consists of 64 acres of waterfront property that are currently owned by the Port of Oakland. The irregularly shaped site is bordered by the Embarcadero and Interstate 880 on the north, the Lake Merritt Channel on the west, and the Oakland Inner Harbor and the Brooklyn Basin on the south and east, as shown in Figure 4. *Existing Conditions*, in Attachment 1 to this Order. The site is currently occupied by a variety of commercial and maritime buildings. Existing land uses include a concrete plant, bulk container storage, and commercial businesses. Recent land uses have included fabricated steel storage, trucking, and a compressed gas distribution facility. A former power plant building has been demolished, and only the foundations and subsurface cooling water tunnels remain. The Ninth Avenue Terminal Shed, a large, one-story, pile-supported warehouse, is located on the east side of the site and occupies the majority of the southeast property line.
3. The Discharger plans to redevelop the Project Site into a mixed-use, waterfront, multi-family, urban residential neighborhood with a retail component surrounded by interconnecting open space (See Figure 5. *Proposed Conditions*, in Attachment 1 to this Order). The proposed open space plan includes a continuous system of pedestrian and bike trails along the site's waterfront and adds a connection for the Bay Trail system. Zarsion OHP I, LLC, and its successors will own the development parcels, and the City of Oakland (City) will own the open space and major streets. (Note: The cross-hatched area between the proposed Channel Park and the proposed South Park in Figure 5. *Proposed Conditions*, in Attachment 1 to this Order, which is labeled "NOT A PART OF PROPOSED PROJECT", is not part of the Project Site. This area is referred to in Project documents as the "Out Parcel.")

4. The Project Site is underlain by fill, and most of the fill surface is developed or landscaped in some fashion. Habitat types present at the Project Site include developed areas, landscaped areas, non-native grassland, ruderal vegetation, and barren areas. Shoreline habitats are mostly artificial in nature. The most common shoreline types are rip-rap, concrete bank, eroding fill, and wharf. Smaller segments of the shoreline are characterized by cordgrass stands or a sandy substrate (See Figure 3. *Existing Habitats and Jurisdictional Features*, in Attachment 1 to this Order).
5. Historic Bay maps indicate that a large portion of the Project Site was once occupied by a large, natural marsh that was bordered on the west by the natural drainage of the Lake Merritt Channel, on the south by San Antonio Creek (now Oakland Inner Harbor), and on the east and north by tidal waters and/or bays associated with the San Antonio Creek watershed. During the late 1800s and early 1900s, most of the Project Site was filled, and the filled areas were subsequently developed for commercial, industrial, and marine-related uses. Additional fill activities occurred in 1944 and between 1953 and 1998. Between the initial filling of the Project Site and into the 1970s, the primary land uses were lumberyards, break-bulk cargo handling, chemical mixing and storage, petroleum product storage in aboveground bulk tank farms, ship repair, compressed gas manufacturing, sand and gravel operations, food warehouses, and trucking operations.
6. The Discharger has been evaluating soil and groundwater contamination at the site since 2002 and, in 2010, executed a California Land Reuse and Redevelopment Act agreement, covering about 34 acres of the Project Site that will be commercially developed, and a Voluntary Cleanup Agreement, covering 30 acres of the site that will be owned by the City and used as parks, with the California Department of Toxic Substances Control (DTSC). A summary of the findings of the soil, soil gas, and groundwater investigations, remedial action objectives and remedial alternatives evaluated to address contamination, site-specific remediation goals, and proposed response actions for the Project Site are presented in the *Final Response Plan/Remedial Action Plan (RP/RAP)* (June 30, 2010, prepared by EKI). The RP/RAP was approved by DTSC in a letter to Oakland Harbor Partners, LLC, dated July 20, 2010 (DTSC Envirostor I.D. No. 70000109). The Discharger will implement the RP/RAP for the development parcels and the open space areas.
7. The measures described in the RP/RAP that will be implemented by the Discharger to protect human health and the environment include: excavation of soils and removal of groundwater in identified source areas of contamination; covering the entire Project Site with at least 2 feet of clean fill overlain by buildings, roads, landscaping, or other facilities, with a marker layer installed to identify the boundary between clean fill and in-place soils; vapor control systems on all buildings and facilities to control potential impacts to indoor air quality; and groundwater monitoring to ensure that the upland remedial measures have been effective at protecting surface water quality.
8. Under current conditions, the water quality of receiving waters adjacent to the Project Site may be impacted by the following exposure routes: the entrainment of contaminated soil particles or other materials in surface water runoff; or the discharge of contaminated groundwater to waters of the State via the existing stormwater infrastructure, including the existing stormwater outfalls at the Project Site (See the red "X"s in Figure 4. *Existing*

Conditions, in Attachment 1 to this Order). See the tables in Attachment 4 to this Order for a summary of chemicals found in groundwater and soils at the Project Site.

9. The Project will control the two potential sources of water quality impairment presented in Finding 8 by placing all residual soil contamination under a minimum of two feet of clean fill material and by replacing the existing stormwater infrastructure with new stormwater infrastructure. The new stormwater infrastructure will protect receiving water quality by isolating stormwater runoff from the Project from residual contamination in site soils and by providing water quality treatment for post-construction stormwater runoff from impervious surfaces on the Project Site. Post-construction stormwater treatment for all phases of the Project shall be consistent with the requirements of the Regional Water Board's Municipal Regional Stormwater NPDES Permit (Order No. R2-2009-0074; NPDES Permit No. CAS612008). The current post-construction stormwater treatment proposal for the Project is included in Attachment 3 to this Order; the Regional Water Board has reviewed this treatment proposal and considers it to be consistent with the requirements of Order No. R2-2009-0074. Construction of each Project phase shall not start until the Executive Officer of the Regional Water Board has approved the final designs for the post-construction stormwater treatment measures to be constructed for that phase.
10. The shoreline of the Project Site will be armored to prevent clean soil layers from being eroded by wave action. Rock riprap bank armoring will be installed along about 1,800 linear feet of shoreline at the South Park Clinton Basin. New rock riprap armoring will range from 10 to 20 inches in diameter and will be placed directly over existing rock armoring or subgrade. Where possible, rock will be placed in tidal areas at low tide when the surface is exposed. Where rock must be placed at deeper contours, it will be placed either from a barge with a skip bucket or from land with a long-reach excavator. Each bucket load will contain about 2 to 3 cubic yards of rock and will be placed slowly, rather than dumped. About 1,200 linear feet of shoreline at Channel Park and 700 linear feet of shoreline at South Park West will be armored with the placement of revetment or similar protection.
11. The Project Site is comprised of 12 parcels, identified as Parcels A, B, C, D, E, F, G, H, J, L, and M in Project documents, and the existing Estuary Park. The Project will be developed in four separate phases, as illustrated in Figure 1. *Phasing Plan, Brooklyn Basin – Oak to 9th Development Plan* in Attachment 2 to this Order, which also identifies the locations of the 12 parcels. Implementation of the four phases will occur over about 14 years, with construction planned to start in 2014 and conclude in about 2022. (Note: work at the existing Estuary Park, which is described as Phase IA in Project documentation, consists of remediation work to be performed at the Existing Estuary Park, east of the Embarcadero and north of the Lake Merritt Channel. Work in Phase IA does not include any impacts requiring approval from the Regional Water Board and is not addressed in this Order.) The Project will impact about 5,350 linear feet of shoreline, as shown in Figure 2. *Shoreline Phasing, Shoreline Improvement Plan*, in Attachment 2 to this Order). The names that the Project has assigned to each of the shoreline segments that will be modified, as well as the project phase in which modification will be implemented are presented in Figure 2. *Shoreline Phasing, from Oak to Ninth Avenue Development, Proposed Shoreline Improvements*, in Attachment 2 to this Order. The impacts to the shoreline in each of the four Project phases are summarized below:

- Phase I (Parcels A, B, C, F, and G) will impact 1,350 linear feet of shoreline (Station 42+50 to Station 56+00 along the Project shoreline) (See Figure 8. *Oak to Ninth Avenue Development, Proposed Shoreline Improvements, Ninth Avenue Wharf* (Moffat & Nichol; September 2010), in Attachment 2 to this Order).
- Phase II (Parcels D, E, H, and J) will impact 2,150 linear feet of shoreline (Station 21+00 to Station 42+50 along the Project shoreline) (See Figure 6. *Oak to Ninth Avenue Development, Proposed Shoreline Improvements, South Park – Clinton Basin*, and Figure 5, *Oak to Ninth Avenue Development, Proposed Shoreline Improvements, Shoreline Park – West*, (Moffat & Nichol; September 2010), in Attachment 2 to this Order).
- Phase III (Parcels K and L) will impact 650 linear feet of shoreline (Station 14+50 to Station 21+00 along the Project shoreline) (See Figure 5. *Oak to Ninth Avenue Development, Proposed Shoreline Improvements, South Park – West* (Moffat & Nichol; September 2010), in Attachment 2 to this Order).
- Phase IV (Parcel M) will impact 1,200 linear feet of shoreline (Station 0+00 to Station 12+00 along the Project shoreline) (See Figure 4. *Oak to Ninth Avenue Development, Proposed Shoreline Improvements, Channel Park* (Moffat & Nichol; September 2010), in Attachment 2 to this Order).

12. **Phase I (Parcels A, B, C, F, G).** This phase will include the following activities:

- a. Demolition of an 88,000 square foot manufacturing and storage building, a 78,400 square foot warehouse building, about 160,000 square feet of the Ninth Avenue Terminal Shed Building, and about 134,000 square feet of pile-supported pier structure and trestle at the existing timber wharf at the future location of Shoreline Park West, while the remaining wharf will be retrofitted to resist seismic loads;
- b. Implementation of the RP/RAP under the regulatory oversight of DTSC, per Finding 6, above;
- c. Construction of a portion of Shoreline Park to the south of parcels A, B, C and D, including all landscaping, pier renovation, construction of bike paths, construction of pedestrian walk ways, and construction of Bay Trail connections. At the Ninth Avenue Wharf component of Shoreline Park, the retained portion of the wharf will be seismically retrofitted. Eighty 60-inch diameter steel piles will be driven through openings cut through the existing deck along the landward edge of the wharf. The piles will be driven in groups of four, and a single concrete cap will provide the structural connection between each group of four piles. All but 14 of the steel piles will be installed above mean high high water (MHHW). The remaining 14 piles will be installed above the mean tide line (MTL) and work on these piles will be scheduled when tides are below the MTL. Pile driving equipment will work from land, and piles will be installed using both vibratory and impact hammers. A new 42-inch diameter stormwater outfall will also be constructed, and repairs will be made to the rock riprap bank armoring (See Figure 8. *Oak to Ninth Avenue Development, Proposed Shoreline Improvements, Ninth Avenue Wharf*, and Figure 13. *Shoreline Park – West, Typical Cross Sections*, (Moffat & Nichol; September 2010), and Figure 20. *Shoreline Park – Outfall # 5*, in Attachment 2 to this Order);

- d. Construction of site improvements, including grading, underground wet and dry utility installation, and construction of streets, bike paths, pedestrian trails, sidewalks, and landscaping;
- e. Renovation of a minimum of 20,000 square feet of the existing 9th Avenue Terminal Shed Building as a mixed-use, commercial/cultural resource building;
- f. Installation of a temporary eight-foot wide asphalt Bay Trail for Phase II and Phase III of the Project.

13. **Phase II (Parcels D, E, H, J, and Shoreline of Parcel M).** This phase will include the following activities:

- a. Implementation of the RP/RAP under the regulatory oversight of DTSC, per Finding 6, above;
- b. Construction of site improvements, including grading, underground wet and dry utility installation, and construction of streets, bike paths, pedestrian trails, Bay Trail connections, sidewalks, and landscaping;
- c. Construction of the remainder of Shoreline Park, including landscaping, construction of bike paths, construction of pedestrian walk ways, construction of Bay Trail connections, and the reconstruction of rock riprap bank armoring in front of the existing bulkhead at the Timber Wharf (See Figure 7. *Oak to Ninth Avenue Development, Proposed Shoreline Improvements, Shoreline Park – West*, and Figure 13. *Shoreline Park – West, Typical Cross Sections*, (Moffat & Nichol; September 2010), in Attachment 2 of this Order);
- d. Construction of portions of Clinton Basin, including the following actions: demolition of existing docks, piles and gangways; driving of concrete piles along the west and east sides of the basin; construction of cast-in-place concrete pile caps; driving of sheet piles along the north side of the basin; excavation and backfill operations to the subgrade for new bank armoring; installation of rock riprap armoring, installation of storm drain outfalls; installation of precast concrete planks, cutoff wall, and fascia; and the construction of a cast-in-place concrete slab (See Figure 6. *Oak to Ninth Avenue Development, Proposed Shoreline Improvements, South Park – Clinton Basin*, Figure 12. *Alternative 1 – Vertical Sheet Pile Bulkhead (Sheet Pile Option Shown – North Segment Only)*, (Moffat & Nichol; September 2010), Figure 14. *Impacts (At Bay Bottom), South Park - Clinton Basin, Surface Area Affected (At Bay Bottom)*, Figure 15. *Mitigation (At Bay Bottom), South Park - Clinton Basin, Surface Area Affected (At Bay Bottom)*, Figure 16. *Section A-A, South Park – Clinton Basin*, Figure 17. *Section B-B, South Park – Clinton Basin*, and Figures 18. *Outfall Profiles, Outfall # 2: Clinton Basin West*, and Figure 19. *Outfall Profiles, Outfall # 3: Clinton Basin North and Outfall # 4: Clinton Basin East*, in Attachment 2 to this Order);
- e. Along a portion of the shoreline at the South Park Clinton Basin open public space area, the Project will construct a new 30-foot wide concrete boardwalk. The concrete boardwalk will be a pile-supported structure using precast concrete and cast-in-place concrete elements. About 150 concrete piles will be required to support the boardwalk, oriented in three rows parallel to the shoreline. Each pile will be 18-inch square or 18-inch octagonal in cross-section and about 65 feet long. A land-based or barge-mounted impact hammer will be used to install the concrete piles. Of the estimated 150 piles, 88 will be located below MHHW. Most of the piles located

below MHHW can be driven when the shoreline is exposed at low tide. However, some piles will be installed in shoreline areas below mean lower low water (MLLW). Cast-in-place elements of the boardwalk will consist of pile caps (transverse), cutoff walls, and slabs (finished surface). The boardwalk deck will be constructed of concrete with a surface area of about 41,750 square feet;

- f. Construction of bank armoring at Channel Park, including the following actions: excavation of bank to stable sub-grade (including construction of an earth berm along the Bay edge where feasible, to keep the work area dry), installation of a geomembrane over the stable slope; placement of imported soil fill over the geomembrane; installation of geotextile fabric over the imported fill soil; placement of shoreline revetment; and the removal of the temporary soil berm along the shoreline (See Figure 4. *Oak to Ninth Avenue Development, Shoreline Improvements, Channel Park*, Figure 9. *Oak to Ninth Avenue Development, Shoreline Improvements, Channel Park – Typical Cross Sections* (Moffat & Nichol; September 2010), and Figure 10. *Oak to Ninth Avenue Development Project, Shoreline Improvements, South Park (West) – Typical Cross Section* (Moffat & Nichol; September 2010), in Attachment 2 of this Order);
- g. Construction of new 36-inch diameter stormwater outfalls in the new bank armoring along the basin (See Figure 18. *Outfall Profiles, Outfall # 2: Clinton Basin West*, and Figure 19. *Outfall Profiles, Outfall #4, Clinton Basin East*, in Attachment 2 to this Order). A new outfall will also be constructed through the vertical sheet pile at the northern shoreline of Clinton Basin; the end of this outfall pipe will be cut approximately flush with the wall, with a backflow prevention gate installed at the pipe end (See Figure 19. *Outfall Profiles, Outfall #3, Clinton Basin North*, in Attachment 2 to this Order).

14. **Phase III (Parcels K and L).** This phase will include the following activities:

- a. Demolition of about 46,000 square feet of marine, storage, service, manufacturing, and industrial uses;
- b. Implementation of the RP/RAP under the regulatory oversight of DTSC, per Finding 6, above;
- c. Construction of site improvements at South Park (West), including: landscaping; construction of bike paths; construction of pedestrian walk ways, and construction of Bay Trail connections;
- d. Construction of site improvements, including grading, underground wet and dry utility installation, and construction of streets, bike paths, pedestrian trails, sidewalks, and landscaping;
- e. Construction of bank armoring at South Park (West) including the following actions: excavation of bank to stable sub-grade (including construction of an earth berm along the Bay edge where feasible, to keep the work area dry), installation of a geomembrane over the stable slope; placement of imported soil fill over the geomembrane; installation of geotextile fabric over the imported fill soil; placement of shoreline revetment; and the removal of the temporary soil berm along the shoreline (See Figure 5. *Oak to Ninth Avenue Development, Proposed Shoreline Improvements, South Park - West*, Figure 10. *Oak to Ninth Avenue Development Project, Shoreline Improvements, South Park (West) – Typical Cross Section*, and Figure 13. *Shoreline Park - West, Typical Cross Sections* (Moffat & Nichol; September 2010), in Attachment 2 of this Order);

- f. Construction of a new 24-inch diameter stormwater outfall in the bank armoring at Channel Park (See Figure 18. *Outfall Profiles, Outfall #1, Channel Park*, in Attachment 2 of this Order).
15. **Phase IV (Parcel M Uplands).** This phase will include the following activities:
 - a. Demolition of onsite structures;
 - b. Implementation of the RP/RAP under the regulatory oversight of DTSC, per Finding 6, above;
 - c. Construction of Channel Park, including landscaping, construction of bike paths, construction of pedestrian walk ways and construction of Bay Trail connections;
 - d. Site improvements including grading, underground wet and dry utility installation, and construction of streets, bike paths, pedestrian trails, sidewalks, and landscaping;
 - e. Installation of a temporary Bay Trail upon termination/expiration of the Berkeley Ready Mix lease, but no earlier than June 1, 2016.
16. Habitat types at the Project Site include developed areas, landscaped areas, non-native grassland, ruderal vegetation, and barren areas. Shoreline habitats are mostly artificial in nature, consisting of rock rip-rap, concrete bank, eroding fill, and wharf. Stands of cordgrass are present in a few locations, mostly located along the western shoreline of Clinton Basin (See the Figure 3. *Existing Habitats and Jurisdictional Features*, in Attachment 1 to this Order). These cordgrass stands are too small to support populations of tidal marsh wildlife species (e.g., salt marsh common yellowthroat, marsh wren), but they provide foraging habitat for some species of waterbirds and cover for common wildlife species that occur in the adjacent uplands.
17. Project impacts to jurisdictional waters total 1.86 acres. These impacts include the following fill: Bay waters (1.84 acres) during Phase II, a seasonal wetland (0.014 acre) during Phase III, and a drainage ditch (0.003 acre) during Phase II. Project impacts to Bay waters are presented in Table 3: *Impact Construction Schedule*, in Attachment 2 to this Order (in the column “Decrease in Bay Surface Area at mean high water (MHW) [net]”). The 1.84 acres of Bay water fill will consist of placing fill in 0.92 acre of open waters to create new uplands and placing 0.92 acres of fill in open waters to create new shoreline revetments, associated with reconfiguration of Clinton Basin in Phase II of the Project (See Figure 6. *Oak to Ninth Avenue Development, Proposed Shoreline Improvements, South Park – Clinton Basin*, Figure 12. *Alternative 1 – Vertical Sheet Pile Bulkhead (Sheet Pile Option Shown – North Segment Only)*, (Moffat & Nichol; September 2010), Figure 14. *Impacts (At Bay Bottom), South Park - Clinton Basin, Surface Area Affected (At Bay Bottom)*, Figure 15. *Mitigation (At Bay Bottom), South Park - Clinton Basin, Surface Area Affected (At Bay Bottom)*, Figure 16. *Section A-A, South Park – Clinton Basin*, and Figure 17. *Section B-B, South Park – Clinton Basin*, in Attachment 2 to this Order). As is described in Finding 19, 0.50 acres of Bay fill will be removed when existing revetments are removed. Therefore, offsite mitigation is being required for net fill of 1.36 acres of fill, consisting of 1.34 acres of Bay fill and 0.017 acres of wetland and drainage ditch.
18. The Project will create 0.69 acres of open waters by removing upland soils, resulting in a net decrease of Bay Surface Area (at MHW) of 0.65 acre (solid fill) when compared with the net amount of 1.34-acres of Bay water impacts. Upland soil will be removed in the following increments: 0.04 acre at South Park (Clinton Basin) in Phase II of the Project; 0.64 acre at Channel Park in Phase II of the Project; and 0.01 acre at South Park (West) in Phase III of the

Project (see the far right column in Table 3: *Impact Construction Schedule*, in Attachment 2 to this Order, as well as Figures 4, 5, 6, 9, and 10 from *Oak to Ninth Avenue Development, Proposed Shoreline Improvements* (Moffat & Nichol; September 2010), Figure 14. *Impacts (At Bay Bottom)*, Figure 15. *Mitigation (At Bay Bottom)*, and the Figure 2. *Shoreline Phasing*, in Attachment 2 to this Order). Table 3: *Impact Construction Schedule*, in Attachment 2 to this Order, summarizes Bay excavation and fill quantities associated with each Project phase.

19. Armoring of currently un-armored sections of shoreline and rehabilitation of existing bank armoring will result in an increase of 0.42 acre of new shoreline revetment at the following locations: 0.35 acre (1,020 LF) at South Park (Clinton Basin) in Phase II of the Project; 0.02 acre (170 LF) at Channel Park in Phase II of the Project; and 0.05 acre (250 LF) along South Park (West) in Phase III of the Project. The rehabilitation of 1.13 acres of existing, deteriorating bank revetments will occur at the following locations: 0.01 acre (50 LF) at Shoreline Park (Ninth Avenue Wharf) in Phase I of the Project; 0.35 acre (560 LF) at Shoreline Park (West) in Phase II of the Project; 0.39 acres (1,340 LF) at South Park (Clinton Basin) in Phase II of the Project; 0.29 acre (1,200 LF) at Channel Park in Phase II of the Project; and 0.09 acre (700 LF) at South Park (West) in Phase III of the Project. Summaries of dredge and fill quantities for shoreline stabilization are presented in Table 1: *Construction Quantities*, and Table 3: *Impact Construction Schedule*, in Attachment 2 to this Order.
20. Fill of Bay waters in the Oakland Inner Harbor is an unavoidable impact of the Project. Along the Project's shoreline, the amount of new fill is the minimum necessary to provide bank stabilization. The majority of the Project's permanent impacts to open water will be associated with construction of the new shoreline promenade and the new Gateway Park at Clinton Basin. Bay fill will be used to stabilize and straighten the shoreline in order to create a uniform promenade edge around the marina. The existing eastern end of Clinton Basin will be filled to increase the size of the new Gateway Park, which will provide necessary space for public access between the end of Clinton Basin and the Embarcadero roadway. At present, the available space between Clinton Basin and the Embarcadero roadway limits movement between Project components constructed in Phase II and Phase III of the Project (See Figure 6. *Oak to Ninth Avenue Development, Proposed Shoreline Improvements, South Park – Clinton Basin*, Figure 12. *Alternative 1 – Vertical Sheet Pile Bulkhead (Sheet Pile Option Shown – North Segment Only)*, Figure 14. *Impacts (At Bay Bottom), South Park - Clinton Basin, Surface Area Affected (At Bay Bottom)*, Figure 15. *Mitigation (At Bay Bottom), South Park - Clinton Basin, Surface Area Affected (At Bay Bottom)*, Figure 16. *Section A-A, South Park – Clinton Basin*, Figure 17. *Section B-B, South Park – Clinton Basin*, in Attachment 2 to this Order). In July 2010, the Project design was modified to reduce Bay fill in Clinton Basin by 1.17 acres, from 1.71 acres to 0.54 acre, as shown in Table 2: *Permit Related Quantities*, in Attachment 2 to this Order. This reduction was accomplished by moving the proposed riprap shoreline on the western and eastern edges of Clinton Basin landward by 26.5 feet and the southern edge of Gateway Park landward by 63.75 feet.
21. The Discharger filed an application for Clean Water Act section 401 Water Quality Certification and Waste Discharge Requirements (WDRs) with the Regional Water Board on December 8, 2009. The application was subsequently completed by additional information submitted on September 30, 2010, November 29, 2010, October 15, 2013, and August 5, 2014.

22. The Discharger has applied to the U.S. Army Corps of Engineers (Corps) (Corps File No. 297020S) for an individual permit under section 404 of the Clean Water Act (33 U.S.C. § 1344), as amended, and section 10 of the Rivers and Harbors Act of 1899 (33 USC § 403), as amended. The Corps issued a Public Notice for the Project on September 5, 2012, (Corps File No. 29702S) but has not issued a permit for the Project at this time.
23. On July 16, 2012, the United States Fish & Wildlife Service (USFWS) provided informal consultation for the Project's potential impacts to the California least tern, under the authority of Section 7 of the Endangered Species Act (ESA) (Reference No. 81420-2011-I-0652). USFWS determined that the Project may affect, but is not likely to adversely affect California least tern. This determination was based on: (1) the three-mile distance of the Project Site from the closest known California least tern breeding colony; (2) scheduling dredging activities outside of the California least tern breeding season; (3) the lack of California least tern breeding habitat within the Project Site; and (4) the historic and current disturbed conditions of the sites.
24. The National Marine Fisheries Service (NMFS) provided consultation for the Project's impacts to listed species under the authority of Section 7 of the ESA, as amended (16 U.S.C. 1531 *et seq.*), and the Essential Fish Habitat (EFH) provisions of the Magnuson Stevens Fishery Conservation and Management Act, in the January 13, 2013, consultation on the Project (Reference No. 2011102282). The NMFS consultation evaluated the Project for potential adverse effects to threatened central California coast (CCC) steelhead, threatened green sturgeon, and designated critical habitat. The NMFS consultation concluded that, because of man-made changes to the Oakland Estuary, it no longer provides rearing habitat for CCC steelhead and, therefore, steelhead juveniles and adults are unlikely to occur in the vicinity of the Project during their seasonal migration through San Francisco Bay. For green sturgeon, the NMFS consultation concluded that there is a potential for fish to be impacted by demolition or construction impacts on water quality. The Project's demolition activities, construction of shoreline stabilization measures, placement of in-water fill, and pile driving activities will disturb the substrate and are likely to result in temporary increases in turbidity and re-suspension of contaminated sediments in the adjacent water column. Based on sediment data collected near the Project Site (See the tables in Attachment 4 to this Order), several contaminants of concern (e.g., PCBs PAHs, and copper) in sediment at the Project Site are present at concentrations above bio-accumulation triggers for Dredged Material Testing Thresholds for San Francisco Bay Area Sediments (Regional Water Board, May 2000 staff report, *Beneficial Reuse of Dredged Materials: Sediment Screening and Testing Guidelines*, or most current revised version). Any toxic metals and organics absorbed or adsorbed to fine-grained particulates in sediment may become biologically available to organisms either in the water column or through food chain processes. Although construction activities may be confined to a localized area, tides and currents can have a significant influence on the dispersal of suspended sediments and contaminants into adjacent areas. Increased levels of turbidity and contaminated sediments can affect listed fish species by disrupting normal feeding behavior, reducing growth rates, increasing stress levels, reducing respiratory functions, and other physiological impacts. To minimize impacts associated with turbidity and contaminants, the Discharger shall use silt curtains and/or sediment berms during excavation activities, cut piles at the mudline if they break off during extraction and only

schedule excavation and backfill activities during periods of low tide. With the implementation of these measures, NMFS anticipates that green sturgeon will not be exposed to suspended contaminated sediments and turbidity at levels that would result in significant behavioral and physical impacts. With implementation of the measures in provisions 7, 8, 9, and 10, NMFS has determined that the proposed project is not likely to adversely affect CCC steelhead, green sturgeon, or designated critical habitat.

25. Clinton Basin is known to contain sediments with high concentrations of contaminants of concern (e.g., PCBs PAHs, copper), and this significantly reduces the value of the area for foraging fish. Post-construction, the amount of area with contaminated sediments in the Clinton Basin will be reduced from pre-project levels, although an area of about 0.4 acres in the Clinton Basin containing contaminated sediment will be exposed during construction and remain exposed after construction is completed (*i.e.*, no revetment will be placed on top of these areas). The Project's creation of 0.64 acres of open water and mudflat habitat along 1,200 linear feet of Channel Park and the creation of 0.55 acres of tidal and open water habitat along the shoreline at Channel Park and South Park West are expected to provide uncontaminated areas with high habitat complexity and increased prey abundance for listed fish. The NMFS consultation concluded that, although forage resources for fish that feed on the benthos are expected to be temporarily reduced within different portions of the Project area during the various phases of multi-year construction activities, the forage area that will be lost comprises a small proportion of the total forage available to green sturgeon in the action area. In the long term, the restoration of open water and mudflat habitat is anticipated to increase the amount of natural cover and prey available to CCC steelhead and green sturgeon in the action area.
26. The Project's placement of 88 18-inch square or 18-inch octagonal concrete piles below MHHW at the new concrete boardwalk along Clinton Basin may affect green sturgeon through exposure to high underwater sound levels. The Project's placement of 14 steel piles for the Ninth Avenue Terminal Wharf at the mean tide line has the potential to injure or kill fish that may be exposed to high levels of elevated underwater sound pressure waves generated from the use of impact hammers to drive steel piles. However, the Project's NMFS consultation (see prior finding) states that hydroacoustic data collected from similar projects in the San Francisco Bay Area indicate that the use of an impact hammer to install the project's 18-inch concrete piles at the boardwalk will not result in sound levels that injure or kill fish. Disturbance and noise associated with preparations for pile driving will likely startle green sturgeon in the project vicinity and result in temporary dispersion from the action area. Because green sturgeon are benthically oriented, and are likely to detect vibrations in the substrate associated with construction, initial piling placement, pile driver set-up, and pile driving, they are not expected to remain within the area or enter into the area during pile driving. For green sturgeon that react behaviorally to the sound produced by pile driving, adequate water depths and carrying capacity in the open water area of the adjacent Oakland Estuary and Central San Francisco Bay provide fish sufficient area to disperse. For the seismic retrofit of the Ninth Avenue Terminal Wharf, all piles will be installed above the water line. Because the characteristic impedance of air is much lower than that of water, a sound source located above the water surface has less effect than under the water. High sound associated with the installation of steel piles at the wharf is expected to be attenuated by surrounding air

and avoid the creation of high underwater sound levels. Thus, for green sturgeon, the NMFS consultation concluded that the potential effects of high underwater sound levels associated with pile driving are expected to be insignificant.

27. Shallow nearshore and intertidal shoreline habitat will be permanently impacted by shading from the 0.84 acres of new boardwalk around Clinton Basin, with the greatest impacts anticipated along the southeast shoreline, due to its orientation relative to sun light. Shading by overwater structures has the potential to reduce the growth of submerged aquatic vegetation, decrease primary productivity, alter predator-prey interactions, change invertebrate assemblages, and reduce the density of benthic invertebrates. Removal of overwater structures at the Ninth Avenue Wharf and Shoreline Park West will reduce shading to EFH by 3.08 acres, and 0.59 acres of floating fill in Clinton Basin will also be removed. The NMFS consultation concluded that, overall, the Project will result in a significant net decrease in shading of EFH.
28. Habitat in the Project area will benefit from the removal of creosote-treated timber piles. Creosote, a distillate of coal tar, is a complex chemical mixture, up to 80 percent of which is comprised of polycyclic aromatic hydrocarbons, a class of chemical compounds that are acutely toxic to aquatic life. About 1,200 timber piles will be removed at Shoreline Park West, many of them treated with creosote. Piles shall be removed entirely or cut at the mudline.
29. The NMFS consultation determined that eelgrass and other submerged aquatic vegetation were not known to occur at the site. However, other ecologically important habitat-forming species were identified at the site, including native oysters (*Ostrea lurida*), which have been observed on creosote pilings, and the native brown rockweed (*Fucus distichus*), which has been documented in abundance along the rip-rap shorelines proposed for realignment, excavation, fill, and re-armoring. *Fucus* is a structuring algae that supports high productivity and biodiversity in the intertidal zone.
30. Development of the Project will reduce the amount of impervious surfaces at the Project Site, but impervious surfaces associated with proposed structures, parking lots, and streets will indirectly impact beneficial uses of the Lake Merritt Channel and the Oakland Inner Harbor through the discharge of urban runoff pollutants (e.g., oil and grease, heavy metals, pathogens, nutrients, pesticides). The Project will mitigate the impacts of stormwater runoff through implementation of the post-construction stormwater control measures described in provisions 21 through 26 and in Attachment 3 to this Order.
31. Impacts to the beneficial uses of the Lake Merritt Channel or Oakland Inner Harbor could also result from the discharge of sediments, construction wastes, or contaminated groundwater during construction. The Project will mitigate these potential impacts through the implementation of the best management practices (BMPs) described in provisions 7, 8, and 10 and by managing groundwater as described in provisions 31 and 32 and in Attachment 4 to this Order.
32. The Project will remove a net amount of 2.24 acres of shadow fill from the Project Site; this net amount results from the removal of 3.08 acres of shadow fill and the creation of 0.84 acres of shadow fill as part of the Project design. Removal of shadow fill will create more open water habitat for shorebirds, waterfowl, marine mammals, and other species that do not use

Bay waters under large piers. The 3.08 acres of shadow fill associated with the Ninth Avenue Wharf will be removed in Phase I of the Project: 1.48 acres of this shadow fill will be removed by dismantling the existing pier at the southwest corner of Shoreline Park (See Figure 8. *Oak to Ninth Avenue Development, Proposed Shoreline Improvements, Ninth Avenue Wharf*, and Figure 1. *Shoreline Phasing*), and 1.60 acres of this shadow fill will be removed at the western portion of the future Shoreline Park (See Figure 7. *Oak to Ninth Avenue Development, Proposed Shoreline Improvements, Shoreline Park – West*, and Figure 2. *Shoreline Phasing* in Attachment 2 of this Order). The Project will create 0.84 acres of new shadow fill under the new boardwalks at Clinton Basin in Phase II of the Project (See Figure 16. *Section A-A, South Park – Clinton Basin*, and Figure 17. *Section B-B, South Park – Clinton Basin*, in Attachment 2 to this Order).

33. The Project will remove 0.59 acres of floating fill in Clinton Basin when the existing marina is removed in Phase II of the Project.

Mitigation Plan

34. As part of mitigation for the Project's impacts to open waters and wetlands, the Discharger will provide offsite mitigation through the purchase of 1.4 acres of credits at the San Francisco Bay Wetland Mitigation Bank (Bank) (Corps File No. 2008 00046S). Mitigation credits through the Bank will offset a cumulative impact total of 1.36 acres to existing open waters (1.34 acres), a seasonal wetland (0.003 acres), and a drainage ditch (0.014 acres) as described in Finding 17.
35. As described in findings 32 and 33, the Project will remove a net amount of 2.24 acres of shadow fill from the Project Site; this net amount is resultant from the removal of 3.08 acres of shadow fill and the creation of 0.84 acres of shadow fill as part of the project design. Removal of shadow fill will create more open water habitat for shorebirds, waterfowl, marine mammals, and other species that do not use Bay waters under large piers. The Project will also remove 0.59 acres of floating fill from the Project Site.
36. As described in Finding 28, the Project will remove about 1,200 timber piles at Shoreline Park West, many of them treated with creosote.
37. As described in Finding 18, the Project will create 0.69 acres of new open Bay waters and/or mudflats in Phase I (0.64 acres along the shoreline of Channel Park), Phase II (0.04 acres at South Park), and Phase III (0.01 acres at South Park) of the Project.

Post-Construction Stormwater Management

38. Stormwater at the Project Site currently flows untreated directly to the Lake Merritt Channel and the Oakland Inner Harbor over land and via localized existing storm drain systems. The portion of the site to the east of Clinton Basin currently discharges untreated runoff through a piped storm drain system that outfalls at multiple locations along the shoreline (See the red "X"s in Figure 4. *Existing Condition*, in Attachment 1 to this Order). The area of the site between Clinton Basin and the Lake Merritt Channel does not have a significant amount of piped drainage and appears to primarily drain overland to the Lake Merritt Channel and the Oakland Inner Harbor; a concrete batch plant, a marina and automotive parts and service centers currently occupy this area. The Estuary Park area is served by a combination of piped

stormwater and overland runoff that discharges directly to the Lake Merritt Channel and the Oakland Inner Harbor.

The Project will reduce the amount of impervious surface area at the site by increasing open space areas, which will include several new parks, in addition to the existing Estuary Park that will remain as open space. The project will remove 14 of 21 outfalls (See Figure 4. *Existing Condition*, in Attachment 1 to this Order) and all of the open drain outfalls through the piers. The outfalls serving the Estuary Park area (Phase IA of the Project) are the only existing outfalls that will remain in use. The Project will construct 5 new outfalls to the Oakland Inner Harbor at the locations identified in Figure 5. *Proposed Conditions*, in Attachment 1 to this Order and Figure 4. *Stormwater Quality Control Plan*, in Attachment 3 to this Order. These outfalls are identified as follows: Outfall 1 – Channel Park; Outfall 2 – Clinton Basin West; Outfall 3 – Clinton Basin North; Outfall 4 – Clinton Basin East; and Outfall 5 – Shoreline Park. Outfalls 1 to 4 are located in areas with proposed shoreline improvements. Outfall 5 is located in an area where no shoreline improvements are proposed and therefore will require construction of a concrete outfall structure within existing bank armoring. Refer to figures 18, 19, and 20 in Attachment 2 to this Order for designs of the five new outfalls.

39. The Discharger submitted a report titled, *Oak to Ninth Avenue Project Stormwater Quality Management Plan*, (BKF Engineers, revised September 24, 2010), which describes the stormwater treatment BMPs for post-construction stormwater runoff from the Project's impervious surfaces. Stormwater treatment controls will be constructed concurrently with each phase of the Project, so that treatment is provided for each completed phase. The stormwater treatment BMPs will be constructed as described in Appendix A in Attachment 3 to this Order. Any changes to the BMPs in Attachment 3 to this Order must be submitted to the Executive Officer of the Regional Water Board for review and approval at least 90 days before construction starts on the phase of the Project that will be treated by the altered BMP proposal. Construction of that phase of the Project shall not commence until the Executive Officer has approved the altered BMP proposal (Construction consists of any disturbance of the site surface that is not directly related to the implementation of the RP/RAP described in Finding 6 of this Order).
40. Post-construction stormwater treatment controls will be implemented according to the following phases and as shown on the attached Stormwater Quality Control Plan (See Figure 1. *Stormwater Quality Control Plan* in Appendix A of Attachment 3 to this Order). Stormwater runoff from Phase I (Parcels A, B, C, F, G), identified as Impervious Area D, will be treated with a combined extended detention/bioretention area (identified as Treatment Area D in the summary of post-construction stormwater treatment in Attachment 3 to this Order and illustrated in Figure 5). Stormwater runoff from Phase II (Parcels D, E, H, and J), identified as Impervious Area C, will be treated using a bioretention area (Treatment Area C and illustrated in Figure 4 in Attachment 3 to this Order). Stormwater runoff from Phase III (Parcels K and L), identified as Impervious Area B, will be treated using a bioretention area (Treatment Area B and illustrated in Figure 3 in Attachment 3 to this Order). Stormwater runoff from Phase IV (Parcel M), identified as Impervious Area A, will be treated using a bioretention area (Treatment Area A and illustrated in Figure 2 in Attachment 3 to this Order). The locations of the four treatment areas for each of the four phases are illustrated in Figure 4. *Stormwater Quality Control Plan* in Appendix A in Attachment 3 to this Order.

Details of the treatment measures are illustrated in Figure 6 and Figure 7 in Attachment 3 to this Order.

Regional Water Board Jurisdiction

41. The Regional Water Board has determined to regulate the proposed discharge of fill materials into waters of the State by issuance of WDRs pursuant to section 13263 of the California Water Code (Water Code) and section 3857 of title 23 of the California Code of Regulations (23 CCR), in addition to issuing certification pursuant to 23 CCR §3859. The Regional Water Board considers WDRs necessary to adequately address impacts and mitigation to beneficial uses of waters of the State from the Project, to meet the objectives of the California Wetlands Conservation Policy (Executive Order W-59-93), and to accommodate and require appropriate changes to the Project.
42. The Regional Water Board provided public notice of the application and this Order on November 21, 2014.
43. This Order is effective only if the Discharger pays all of the required fees conditioned under 23 CCR and in accordance with Provision 27.

Ownership of Project Property

44. On April 9, 2013, the Discharger and Oakland Harbor Partners, LLC, signed the *Assignment and Assumption of Project Materials (Oak to Ninth-Brooklyn Basin)*. By signing this document and making the payments stipulated in the document, the Discharger acquired all of Oakland Harbor Partners, LLC's right, title, and interest in the Oak to Ninth/Brooklyn Basin project (the Project), including all rights under the following agreements, entitlements, and work products: the Purchase and Sale Agreement with the Port of Oakland; the Tideland Trust Exchange Agreement with the Port and the California State Lands Commission; all local land use entitlements related to the Project, including the Development Agreement with the City of Oakland; and all Project work products, including plans, contracts and permit applications. Subsequent to this initial transfer, the Discharger closed escrow on the Project property under the terms of the Purchase and Sale Agreement and the Exchange Agreement on June 10, 2013.

Regulatory Framework

45. The Water Quality Control Plan for the San Francisco Bay Basin (Basin Plan) is the Regional Water Board's master water quality control planning document. It designates beneficial uses and water quality objectives for waters of the State, including surface waters and groundwater. It also includes implementation plans to achieve water quality objectives. The Basin Plan was duly adopted by the Regional Water Board and approved by the State Water Resources Control Board, Office of Administrative Law, and U.S. EPA, where required.
46. The following water bodies are adjacent to the Project Site: Lake Merritt Channel; Oakland Estuary; Brooklyn Basin; and Clinton Basin. With the exception of the Lake Merritt Channel, these water bodies are part of the Oakland Inner Harbor. Figure 2. *Phasing Plan, Brooklyn Basin – Oak to 9th Development Plan* in Attachment 2 to this Order shows the locations of these water bodies with respect to the Project Site. The Basin Plan identifies the beneficial uses of the Oakland Inner Harbor as estuarine habitat (EST), wildlife habitat (WILD), water

contact recreation (REC1), non-contact water recreation (REC2), and navigation (NAV). The Basin Plan identifies the beneficial uses of the Lake Merritt Channel as ocean, commercial, and sport fishing (COMM), estuarine habitat (EST), wildlife habitat (WILD), water contact recreation (REC1), and non-contact water recreation (REC2). Potential project-related impacts to each of these six beneficial uses are discussed below.

47. Potential impacts to ocean, commercial, and sport fishing (COMM) are not likely to be significant. Although some areas of the shoreline will be inaccessible to fishing during Project construction activities along the shoreline, the Project will not have locally significant impacts on the amount of water accessible to fishing. The Project may also have long-term benefits on fishing by reducing the amount of contamination reaching the Lake Merritt Channel from historic contamination and urban runoff.
48. The Project is likely to have temporary impacts to estuarine habitat (EST) and wildlife habitat (WILD). Construction activities (e.g., excavation, soil stockpiling, boring, pile-driving, grading, dredging) would generate loose, erodible soils that, if not properly managed, could be washed into the Lake Merritt Channel or the Oakland Inner Harbor, increasing turbidity and potentially interfering with fish navigation and feeding behavior, as well as introducing any pollutants entrained with the sediment particles into waters of the State. Increased sound pressure levels from pile-driving could also injure, stun, or kill fish in the Oakland Inner Harbor. These potential, temporary impacts shall be minimized and/or avoided through the implementation of applicable BMPs, in accordance with provisions 6, 7, 8, 9, 10, 21, 22, 31, and 32.

Without appropriate mitigation measures, the project could potentially result in impacts to the California least tern. USFWS' informal consultation for the Project (Reference No. 81420-2011-I-0652; July 16, 2012) determined that the Project may affect, but is not likely to adversely affect, California least tern. This determination was based on: (1) the three-mile distance of the Project Site from the closest known California least tern breeding colony; (2) scheduling dredging activities during the August 1 to February 28 work window, which is outside of the California least tern breeding season; (3) the lack of California least tern breeding habitat within the Project Site; and (4) the historic and current disturbed conditions of the sites.

Without appropriate mitigation measures, the Project could result in impacts to threatened green sturgeon and designated critical habitat. The NMFS consultation for the Project concluded that there is a potential for fish to be impacted by demolition or construction impacts on water quality. About 1 acre of aquatic habitat (below MHW) along the Project Site shorelines will be subject to major construction activities, resulting in disturbance and permanent alteration of habitat. Algal and benthic invertebrate communities will be impacted. Soft estuarine mud, which will be disturbed through excavation, fill, and sediment disturbance during piling removal, provides habitat for important prey resources for fish. Rates of benthic recovery range from several months to several years for estuarine muds. Therefore, forage resources for fish that feed on the benthos are expected to be temporarily reduced within different portions of the Project area during the various phases of multi-year construction activities.

To minimize impacts associated with demolition and construction activities, the Discharger shall use silt curtains and/or sediment berms during excavation activities, cut piles at the

mudline if they break off during extraction and only schedule excavation and backfill activities during periods of low tide. With the implementation of these measures, the NMFS consultation concluded that green sturgeon will not be exposed to suspended contaminated sediments and turbidity at levels that would result in significant behavioral and physical impacts (See provisions 7, 8, and 10). Permanent impacts of the Project may benefit estuarine habitat and wildlife habitat by isolating residual contamination at the site from contact with waters of the State, removing 2.24 net acres of over-water shading, removing 0.59 acres of floating fill, removing treated wood pilings, and providing water quality treatment for stormwater runoff from the developed site. The potential creation of up to 0.69 acres of new open water and mudflat habitat along the shoreline of Channel Park and South Park is also likely to improve estuarine habitat and wildlife habitat.

49. The Project will reduce opportunities for water contact recreation (REC1), because the Project will remove the Clinton Basin marina.
50. The Project will benefit non-contact water recreation (REC2), because the Project will increase opportunities for public access to the shoreline at the site, including completion of a portion of the Bay Trail.
51. The Project will have no impacts to Navigation (NAV).
52. The Basin Plan Wetland Fill Policy (policy) establishes that there is to be no net loss of wetland acreage and no net loss of wetland value when the project and any proposed mitigation are evaluated together and that mitigation for wetland fill projects is to be located in the same area of the Region, whenever possible, as the project. The policy further establishes that wetland disturbance should be avoided whenever possible, and, if not possible, should be minimized, and only after avoidance and minimization of impacts should mitigation for lost wetlands be considered.
53. The goals of the California Wetlands Conservation Policy (Executive Order W-59-93, signed August 23, 1993) include ensuring “no overall loss” and achieving a “...long-term net gain in the quantity, quality, and permanence of wetland acreage and values...” Senate Concurrent Resolution No. 28 states that “[i]t is the intent of the legislature to preserve, protect, restore, and enhance California’s wetlands and the multiple resources which depend on them for benefit of the people of the State.” Section 13142.5 of the Water Code requires that the “highest priority shall be given to improving or eliminating discharges that adversely affect wetlands, estuaries, and other biologically sensitive areas.”
54. This Order applies to the permanent fill and indirect impacts to waters of the State associated with the Project, which is comprised of the components listed in findings 11 through 15. Construction of the Project will result in the net permanent placement of fill in 1.34 acres of jurisdictional open waters, consisting of open water in the Oakland Inner Harbor, and in 0.017 acres of seasonal wetlands in uplands.
55. The Discharger has submitted a Clean Water Act section 404 Alternatives Analysis and supplemental information to show that appropriate effort was made to avoid and then to minimize wetland and stream disturbance, as required by the Basin Plan. The Corps approved the Alternatives Analysis on December 10, 2013.
56. The California Environmental Quality Act (CEQA) requires all discretionary projects approved by public agencies to be in full compliance with CEQA, and requires a lead agency

(in this case, the City) to prepare an appropriate environmental document for such projects. The City prepared and certified the *Environmental Impact Report for the Oak to Ninth Mixed Use Development* (EIR) on June 20, 2006, State Clearinghouse No. 2004062013, and filed a Notice of Determination (NOD) with the Alameda County Clerk on June 23, 2006. The EIR found that significant impacts related to the filling of a small wetland and open waters of San Francisco Bay would be mitigated to less than significant levels by the creation of new open water or mudflats and the removal of shadow fill over Bay waters. Subsequent to the certification of the EIR, it was determined that created tidal marshes on public trust lands could not be preserved in perpetuity through a deed restriction or conservation easement. Therefore, Project impacts will be offset through the purchase of 1.4 acres of mitigation credits from the San Francisco Bay Wetland Mitigation Bank. The EIR also identified potentially significant impacts related to water quality from the Project but concluded that these impacts could be mitigated to less than significant levels through the mitigation measures identified in the EIR, such as compliance with the requirements of construction stormwater permits and municipal stormwater permits, issued by the State Water Resources Control Board and the Regional Water Board as National Pollutant Discharge Elimination System (NPDES) permits.

57. The Alameda County Superior Court Order in Case No. RG06-280345 and Case No. RG06-280471 found that the EIR, consisting of the Draft EIR, the Final EIR, and the Addendum to the EIR, prepared and certified by the City and the Oakland Redevelopment Agency in 2006 for the Oak to Ninth Avenue Project failed to comply with CEQA for the following reasons: it did not include a sufficient cumulative impact analysis for the land use section and for the population and housing section; the cumulative impact analyses for geology and seismicity, noise from traffic, hazardous materials, biological resources, visual quality, public services and recreation facilities, and utilities did not sufficiently consider the impact of the project when added to other closely related past and present projects; the traffic analysis relied on an improper ratio theory to evaluate cumulative impacts; and the seismic risk mitigation measures and findings were not supported by sufficient analysis or substantial evidence in the record. Of the subject areas subject to evaluation in the revised analysis for the EIR, only impacts to biological resources are within the jurisdictional purview of the Regional Water Board.
58. The assessment of impacts to biological resources in the revised EIR concluded that the cumulative impacts of past, present, and reasonably foreseeable future projects are not likely to have significant unmitigable impacts to biological resources. In part, this conclusion was based on the requirement for present and reasonably foreseeable future projects to implement mitigation measures consistent with the following regulations, laws, and policies to avoid adverse effects to existing biological resources: the federal and State Endangered Species Acts; the federal Clean Water Act; the City of Oakland Creek Protection Ordinance; and the City of Oakland Oak Tree Protection and Tree Preservation Removal Ordinance. Mitigation measures identified for the Project are typical of the types of mitigation measures required for all development projects located adjacent to wetlands or other jurisdictional waters and that involve construction activities near or in such waters. The mitigation measures that are most relevant to the Project include: avoidance; best management practices; and compensatory mitigation. Avoidance includes the avoidance of resources such as wetlands, special status species habitat, or trees with nesting birds during project design, construction, and operation;

and periods when those activities shall not occur to avoid direct and indirect impacts to certain species, based on behaviors of such species (e.g., breeding periods of certain bird species). Best management practices include standard measures to minimize impacts to waters of the State during construction and operation of the Project (See provisions 6 through 10 of this Order). Compensatory mitigation is provided to address temporary and permanent impacts to waters of the State; this mitigation provides for the replacement of impacted aquatic resources, as is described in greater detail in findings 34, 35, 36, and 37 and provisions 11 and 20 of this Order.

59. The City certified the revised EIR on January 20, 2009, and filed an NOD for the revised EIR with the Alameda County Clerk on January 22, 2009.
60. The Regional Water Board, as a responsible agency under CEQA, has considered the revised EIR, together with the record before the Regional Water Board, including public comments, and finds that the significant environmental impacts of the proposed activities, which are within the Regional Water Board's purview and jurisdiction, have been identified and mitigated to less than significant levels. Specifically, significant impacts from fill of open water and a small wetland and significant impacts to water quality will be mitigated through the mitigation requirements set forth in the EIR and this Order. Further, since certification of the EIR, changes have been incorporated into the Project such that the Project now results in 1.17 acres less of open water fill than was previously proposed by the Discharger and evaluated in the EIR; this reduction lessens the impacts from the fill of open water.
61. Pursuant to 23 CCR sections 3857 and 3859, the Regional Water Board is issuing WDRs and Water Quality Certification for the proposed Project.
62. The Regional Water Board has notified the Discharger and interested parties of its intent to issue WDRs and Water Quality Certification for the Project.
63. The Regional Water Board, in a public meeting, heard and considered all comments pertaining to this Order.

IT IS HEREBY ORDERED that Zarsion-OHP I, LLC., in order to meet the provisions contained in Division 7 of the Water Code and regulations adopted thereunder, shall comply with the following, pursuant to authority under Water Code sections 13263 and 13267:

A. Discharge Prohibitions

1. The direct discharge of wastes, including rubbish, refuse, bark, sawdust, or other solid wastes into surface waters or at any place where they would contact or where they would be eventually transported to surface waters, including flood plains, is prohibited.
2. The discharge of floating oil or other floating materials from any Project activity in quantities sufficient to cause deleterious bottom deposits, turbidity, or discoloration in surface waters is prohibited.
3. The discharge of silt, sand, clay, or other earthen materials from any Project activity in quantities sufficient to cause deleterious bottom deposits, turbidity, or discoloration in surface waters is prohibited.
4. The open water and wetland fill activities subject to these requirements shall not cause a nuisance as defined in Water Code §13050(m).
5. The discharge of decant water from the Project's fill sites and stockpile or storage areas to surface waters or surface water drainage courses is prohibited, except as conditionally allowed following the submittal of a discharge plan or plans as described in the Provisions.
6. The groundwater in the vicinity of the Project shall not be degraded as a result of the placement of fill for the Project.
7. The discharge of materials other than stormwater, which are not otherwise regulated by a separate NPDES permit or allowed by this Order, to waters of the State is prohibited.
8. The discharge of drilling muds to waters of the State, or to where such muds could be discharged to waters of the State, is prohibited.
9. The discharge of earthen fill, construction material, concrete, aggregate, rock rip-rap, and/or other fill materials to waters of the State is prohibited, except as expressly allowed herein.

B. Receiving Waters Limitations

1. The discharge shall not cause the following conditions to exist in waters of the State at any place:
 - a. Floating, suspended, or deposited macroscopic particulate matter or foam in concentrations that cause nuisance or adversely affect beneficial uses;
 - b. Bottom deposits or aquatic growths to the extent that such deposits or growths cause nuisance or adversely affect beneficial uses;
 - c. Alteration of temperature, turbidity, or apparent color beyond present natural background levels;
 - d. Visible, floating, suspended, or deposited oil or other products of petroleum origin; and
 - e. Toxic or other deleterious substances to be present in concentrations or quantities which will cause deleterious effects on wildlife, waterfowl, or other aquatic biota, or

which render any of these unfit for human consumption, either at levels created in the receiving waters or as a result of biological concentration.

2. The discharge shall not cause nuisance, or adversely affect the beneficial uses of the receiving water.
3. The discharge shall not cause the following limits to be exceeded in waters of the State at any one place within one foot of the water surface:
 - a. Dissolved Oxygen: 5.0 mg/L, minimum
The median dissolved oxygen concentration for any three consecutive months shall not be less than 80% of the dissolved oxygen content at saturation. When natural factors cause concentrations less than that specified above, then the discharges shall not cause further reduction in ambient dissolved oxygen concentrations.
 - b. Dissolved Sulfide: 0.1 mg/L, maximum
 - c. pH: The pH shall not be depressed below 6.5 nor raised above 8.5, nor caused to vary from normal ambient pH by more than 0.5 pH units.
 - d. Un-ionized Ammonia: 0.025 mg/L as N, annual median; and 0.16 mg/L as N, maximum
 - e. Nutrients: Waters shall not contain biostimulatory substances in concentrations that promote aquatic growths to the extent that such growths cause nuisance or adversely affect beneficial uses.
4. There shall be no violation of any water quality standard for receiving waters adopted by the Regional Water Board or the State Water Resources Control Board.

C. Provisions

1. The Discharger shall comply with all Prohibitions, Receiving Water Limitations, and Provisions of this Order immediately upon adoption of this Order or as provided below.
2. The Discharger shall submit copies to the Regional Water Board of all necessary approvals and/or permits for the Project, including its associated mitigation, from applicable government agencies, including, but not limited to the City, the Corps, the Bay Conservation and Development Commission (BCDC), and the East Bay Municipal Utilities District (EBMUD). Copies shall be submitted to the Regional Water Board within 60 days after issuance of any permit or other approval.
3. In addition to the requirements of this Order, the Discharger shall comply with any other more stringent requirements imposed by the Corps, BCDC, and the City.
4. Construction shall not commence on any phase of the Project until all required documents, reports, plans, and studies required in the Provisions associated with that phase of the Project have been submitted to the Executive Officer or the Regional Water Board and found acceptable by the Executive Officer or the Regional Water Board.

5. Prior to placing any imported fill material along the shoreline of the Project Site, including all placement of fill in areas below the top of bank, the Discharger shall submit written documentation that the chemical concentrations in the imported fill soil are in compliance with the protocols specified in:
- The Dredged Material Management Office (DMMO) guidance document, *Guidelines for Implementing the Inland Testing Manual in the San Francisco Bay Region* (Corps Public Notice 01-01, or most current version) with the exception that the water column bioassay simulating in-bay unconfined aquatic disposal shall be replaced with the modified effluent elutriate test, as described in Appendix B of the Inland Testing Manual, for both water column toxicity and chemistry (DMMO suite of metals only); and,
 - Regional Water Board May 2000 staff report, *Beneficial Reuse of Dredged Materials: Sediment Screening and Testing Guidelines*, or most current revised version.

Regional Water Board staff shall review and approve data characterizing the quality of all material proposed for use as fill prior to placement of fill at any of the shoreline improvement areas at the Project Site. Modifications to these procedures may be approved on a case-by-case basis, pending the Discharger's ability to demonstrate that the imported fill material is unlikely to adversely impact beneficial uses.

Construction Best Management Practices (BMPs)

6. To be protective of the California least tern colony on the former Alameda Naval Air Station, located about three miles west of the Project Site, and to be consistent with the USFWS informal consultation for the Project, dredging activities may only occur during the August 1 to February 28 work window, which is outside of the California least tern breeding season.
7. To place fill over a 0.90 acre section of Clinton Basin at the site of the Gateway Park, steel sheet piles will be installed across the channel using a vibratory pile driver to enclose the fill site. Fill materials shall be carefully placed behind the sheet pile and shall not be dumped or dropped directly into open waters. To prevent fish from being trapped behind the bulkhead, a 15-foot-wide gap shall be left in the sheetpile while the gravel and rock filling is taking place. A turbidity curtain shall be used to minimize the discharge of suspended sediment. The curtain shall be deployed with sufficient space at the bottom to enable fish to move out of the area and discourage fish from entering the area. Prior to the full closure of the bulkhead, a seine shall be used by a biological monitor to guide any remaining fish out of the work site to open water in the Oakland Estuary. The gap in the bulkhead shall be sealed with more sheet piles immediately after seining, and filling will then be completed.
8. The Discharger shall implement the following measures to avoid negative impacts to aquatic organisms and habitat during construction:
- a. All in-water construction work will be limited to the period between June 1 and December 1.
 - b. To the maximum extent possible, work in tidal areas will be completed at low tide so as to minimize in-water work. To isolate earthwork activities from the tidal

waters of the Oakland Estuary, a temporary berm of existing fill materials will be left on the outboard edge of the shore, or work will occur during low tide periods. If a temporary berm is used, it will be removed upon completion of the work by excavating from the top of slope down to the existing mean tide line. Berm removal shall be completed at low tide.

- c. During demolition of overwater structures, fixed or floating platforms shall be installed beneath work sites to prevent material and debris from falling into the water.
 - d. Where necessary to conduct in-water grading work involving either excavation or placement of fill in tidal waters, a weighted silt curtain suspended from a floating boom shall be emplaced in the estuary around the perimeter of the work site. The curtain is intended to simultaneously exclude fish from active work areas and reduce turbidity in the estuary. A biological monitor shall be onsite whenever the turbidity curtains are being installed or moved, and inspect the curtained work areas prior to work commencing.
 - e. A biological monitor shall be on site during construction activities below the elevation of MHHW at the Gateway Park construction site.
 - f. Pile driving in Clinton Basin for the boardwalk shall occur at low tide when inundation of the near shore area is shallow or when the Bay floor at the pile driving location is fully exposed, whenever possible. Piles driven in waters greater than 1 foot in depth shall be driven using the soft-start procedure; piles shall be driven with the least force necessary; a wood cushion shall be placed between the impact hammer and pile top; and only one impact hammer shall be operated at a time.
 - g. Stormwater control measures, such as the installation of silt fences, shall be used to control or eliminate sediment discharges and other potential pollutants from entering the waterway during construction. These measures will be implemented according to a Storm Water Pollution Prevention Plan (SWPPP) in compliance with the statewide Construction General Permit (see provisions 21 and 22) and City of Oakland Creek Protection Permit.
9. New pilings installed for the Project shall be made of inert material (e.g., concrete) that will not leach contaminants into the waters of the Oakland Inner Harbor.
10. The Discharger shall implement the following Essential Fish Habitat (EFH) Conservation Recommendations, which were presented in the NMFS consultation to avoid, minimize, or otherwise offset anticipated adverse effects to EFH from contaminant exposure, sediment disturbance, shading, disturbance to existing native algae and permanent loss of subtidal habitat associated with Project construction:
- a. The Discharger shall develop a remedial action plan to minimize the exposure of aquatic organisms to contaminants associated with residual chemical concentrations in newly exposed sediment for each phase of Project construction. Remedial action plans shall be submitted to the Executive Officer at least 30 days prior to initiation of excavation activities along the shoreline of the Project Site for review and approval.
 - b. The Discharger shall minimize the disturbance of contaminated sediment during piling removal. If piles break and/or cannot be removed entirely, pilings shall be cut *at* the mudline, rather than *below* the mudline.

- c. To reduce impacts to EFH from shading at the Project Site, the Discharger shall incorporate light transmitting materials or design features into the new boardwalk along the southeast shoreline of Clinton Basin, to achieve a target of between 5 and 40 percent light transmittance.
- d. Where replacement of existing rip-rap and other hard intertidal structures is planned, the Discharger shall take actions to preserve the *Fucus* currently growing along the shoreline edges, as recommended in the Assessment of the Habitat Value of Pier Pilings (Zabin 2011) (See Attachment 5).

Compensatory Mitigation

11. To provide mitigation for the Project's impacts to waters of the State, the Discharger shall provide the following mitigation measures in conformance with the schedule in Table 3, *Impact/Mitigation Construction Schedule*, in Attachment 2 to this Order:
 - a. Purchase 1.4 acres of mitigation credits from the Bank as described in Finding 34;
 - b. Remove a net minimum of 2.24 acres of shadow fill from Bay waters as described in Finding 35;
 - c. Remove a minimum of 0.59 acres of floating fill from Clinton Basin as described in Finding 35;
 - d. Remove about 1,200 timber piles at Shoreline Park West, many of them treated with creosote, as described in Finding 36);
 - e. Create a minimum of 0.69 acres of new open water and/or mudflats, as described in findings 18 and 37; and
 - f. Document attaining at least 5 percent light transmittance in the new boardwalk constructed along the southeast shoreline of Clinton Basin.
12. Not later than 90 days prior to the start of construction for each phase of the Project (defined as site grading that is not solely related to the implementation of the RP/RAP described in Finding 6 of this Order), the Discharger shall submit final plans for the creation of each area of proposed open water and/or mudflat to be created in that phase of the Project to the Executive Officer for review and approval. Construction of each Project phase shall not start until the Executive Officer has approved the final mitigation plan for that phase.
13. As-built plans for each area of open water and/or mud flat created as mitigation for the Project's impacts to waters of the State site shall be prepared and submitted to the Executive Officer within six weeks of the completion of construction of each area of open water and/or mudflat. As-built plans shall be accompanied by an as-built report that describes any changes to the approved plans that were necessary during creation of open water and/or mudflat, as well as a technical justification for any design changes that were necessary in the field.
14. Within six weeks of completing the removal of any portion of shadow fill that is required by this Order as mitigation for Project impacts to waters of the State, the Discharger shall submit a report documenting the removal of the shadow fill to the Executive Officer.
15. Within six weeks of completing the removal of any creosote-treated timber pilings from the Project site that is required by this Order as mitigation for Project impacts to waters of the State, the Discharger shall submit a report documenting the removal of the timber pilings, including an estimate of the number of pilings completely removed and the number of pilings cut off at the mudline, to the Executive Officer.

16. Within six weeks of completing the boardwalk along the shore of Clinton Basin, the Discharger shall submit a report documenting the attainment of a minimum of 5 percent light transmittance in the boardwalk along the shoreline of Clinton Basin to the Executive Officer.

Monitoring and Reporting

17. All technical and monitoring reports required pursuant to this Order (e.g., provisions 5, 10, 11, 12, 13, 14, 15, 16, 18, 20, 22, 23, 24, and 25) are being required pursuant to section 13267 of the Water Code. Failure to submit reports in accordance with schedules established by this Order or failure to submit a report of sufficient technical quality acceptable to the Executive Officer may subject the Discharger to enforcement action pursuant to section 13268 of the Water Code.
18. Annual reports shall be submitted to the Regional Water Board by January 31 following each year of Project construction, until the required mitigation features have been implemented. Reports shall include an assessment of the amount of open water and/or mudflats created in each year of Project implementation, the amount of shadow fill removed and/or created in each year of Project implementation, the amount of creosote treated piles that have been removed in each year of Project implementation, and the amount of boardwalks along the shoreline of Clinton Basin that have been constructed with at least 5 percent light transmittance in each year of Project implementation. Reports shall include a description of the methods used to implement mitigation features and representative photographs of each mitigation feature. Reporting may be discontinued when all of the mitigation measures in findings 34 through 37 and Provision 20 have been implemented.

Electronic Reporting Format

19. In addition to print submittals, all reports submitted pursuant to this Order must be submitted as electronic files in PDF format. The Regional Water Board has implemented a document imaging system, which is ultimately intended to reduce the need for printed report storage space and streamline the public file review process. Documents in the imaging system may be viewed, and print copied made, by the public, during file reviews conducted at the Regional Water Board's office. All electronic files, whether in PDF or spreadsheet format, shall be submitted via email (only if the file size is less than 3 MB) or on CD. CD submittals may be included with the print report.

Notice of Mitigation Completion

20. Mitigation for impacts to open waters will be satisfied through documentation of the completion of the mitigation measures specified in Provision 11, in conformance with the schedule in Table 3, *Impact/Mitigation Construction Schedule*, in Attachment 2 to this Order:
 - a. Purchase of 1.4 acres of mitigation credits from the Bank; proof of such purchase shall be submitted to the Executive Officer no later than March 1, 2015;
 - b. Removal of a net minimum of 2.24 acres of shadow fill from Bay waters;
 - c. Removal of a minimum of 0.59 acres of floating fill from Clinton Basin;
 - d. Creation of a minimum of 0.69 acres of open waters and/or mudflats; and
 - e. Documentation of attaining at least 5 percent light transmittance in the new boardwalk constructed along the shoreline of Clinton Basin.

Project Site Stormwater Management

21. The Discharger shall comply with the General Permit for Discharges of Storm Water Associated with Construction Activity (Construction General Permit Order No. 2012-0006-DWQ; NPDES Permit No. CAS000002).
22. The Discharger shall prepare and implement a site-specific Stormwater Pollution Prevention Plan (SWPPP) for the construction of each phase of the Project, in accordance with the requirements, provisions, limitations, and prohibitions of the General Construction Permit for discharges of stormwater associated with construction activity. Construction of each phase shall not commence until the Executive Officer has approved the SWPPP for that phase.
23. No later than 90 days prior to the start of construction for each of the four phases of the Project, the Discharger shall submit final plans for the post-construction stormwater treatment measures for the impervious surfaces that are to be created in that phase of the Project to the Executive Officer for review and approval. Stormwater treatment measures shall be consistent with the designs and phasing in Attachment 3 to this Order and findings 38, 39, and 40. Construction of each Project phase shall not start until the Executive Officer has approved the final designs for the post-construction stormwater treatment measures to be constructed for that phase (Note: "Construction of a phase" does not include work that is solely necessary to implement the RP/RAP described in Finding 6 of this Order).
24. As-built plans for the post-construction stormwater treatment feature for each phase of the Project shall be prepared and submitted to the Regional Water Board within six weeks of the completion of construction and planting of each post-construction stormwater treatment feature. As-built plans shall be accompanied by an as-built report that describes any changes to the approved plans that were necessary during construction of the stormwater treatment feature, as well as a technical justification for any design changes that were necessary in the field. The technical justification must demonstrate that the constructed treatment measure is consistent with the requirements of Regional Water Board Order No. R2-2009-0074 (see Attachment 3 to this Order).
25. The Discharger, or its successors, is required to ensure that the post-construction stormwater treatment BMPs described in the *Oak to Ninth Avenue Project Stormwater Quality Management Plan*, (BKF Engineers, revised September 24, 2010 (see Attachment 3 to this Order), or any alterations of those BMPs that receive approval from the Executive Officer are monitored, inspected, and maintained in perpetuity. Any transfer of this responsibility from the Discharger to another party must be approved by the Executive Officer before the responsibility may be transferred to another party. The City has conditioned the project (COA #38 of Exhibit C to City Approval Documents) to establish a Community Facilities District (CFD) or other similar funding mechanism for maintenance of parks, open space, and public right-of-way. Source control measures (e.g., marking of storm rain inlets, street sweeping, requirements for pesticide/fertilizer application, isolation of waste storage areas from stormwater runoff) and the maintenance of post-construction stormwater treatment BMPs (e.g., bioretention areas and detention areas) shall be among the Project Site maintenance items included as part of the CFD that is required prior to approval of the final map of the first phase of the Project. Before transferring any of the Discharger's responsibilities that are specified in the Provisions of this Order to a CDF, or similar entity, the Discharger shall submit the terms of such a transfer of responsibility to the Executive Officer for review and

approval. Upon approval of any such transfer of responsibility, the Discharger may apply to have this Order amended to reflect such a transfer of responsibilities for the implementation of source control measures and to ensure the monitoring, inspection, and maintenance of the post- construction stormwater treatment BMPs in perpetuity.

26. The *City of Oakland Source Control Measures to Limit Stormwater Pollution* (See Appendix B in Attachment 3 to this Order) shall be implemented at the Project Site, as appropriate for each Project phase.

Fees

27. This Order combines WDRs and Clean Water Act section 401 Water Quality Certification provisions. The application fee and annual fees shall reflect this, and consist of the following:

The fee amount for the WDRs and Water Quality Certification shall be in accordance with the current fee schedule, per CCR Division 3, Chapter 9, Article 1, section 2200(a)(3), based on the discharge size. The full application fee for the Project's fill of 1.36 acres of waters of the State is \$7,711, which must be paid in full to the Regional Water Board by February 1, 2015. After the initial year, annual fees in accordance with CCR Division 3, Chapter 9, Article 1, section 2200(a)(3) shall be billed annually to the Discharger until Project implementation is completed. The fee payment shall indicate the Order number, WDID number, and the applicable year.

General Provisions

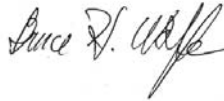
28. The Discharger shall comply with all the Prohibitions, Effluent and Receiving Water Limitations, and Provisions of this Order immediately upon adoption of this Order or as provided in this Order.
29. All reports pursuant to these Provisions shall be prepared by professionals registered in the State of California.
30. The Discharger shall immediately notify the Regional Water Board by telephone and e-mail whenever an adverse condition occurs as a result of this discharge. Such a condition includes, but is not limited to, a violation of the conditions of this Order, a significant spill of petroleum products or toxic chemicals, or damage to control facilities that would cause noncompliance. Pursuant to Water Code §13267(b), a written notification of the adverse condition shall be submitted to the Regional Water Board within two weeks of occurrence. The written notification shall identify the adverse condition, describe the actions necessary to remedy the condition, and specify a timetable, subject to the modifications of the Regional Water Board, for the remedial actions.
31. Should discharges of otherwise uncontaminated groundwater contaminated with suspended sediment be required from the Project Site, where such discharges are not otherwise covered by an applicable NPDES permit, such discharges may be considered covered by the General Permit, following the submittal of a discharge/treatment plan, acceptable to the Executive Officer, at least 30 days prior to such a discharge.
32. Excavation dewatering may be performed in open excavation areas that extend below the water table both during remedial activities and during construction activities. All extracted groundwater will be either hauled offsite to a facility approved by DTSC, discharged to

EBMUD facilities, or discharged to a storm sewer or directly to surface water under an NPDES permit. At the time any specific phase of the Project is undertaken that will involve groundwater extraction, an analysis will be made as to whether it is cost effective and appropriate to discharge to EBMUD or to surface water. The procedures for discharging to EBMUD facilities or for discharging to surface water under an NPDES permit are generally described in Attachment 4 to this Order.

33. The Discharger shall notify the Regional Water Board in writing at least 30 days prior to the actual start date for each phase of the Project (i.e., prior to the start of grading or other construction activity for any Project component that is not solely related to the remediation of existing contamination at the Project Site).
34. The Discharger shall at all times fully implement and comply with the engineering plans, specifications, and technical reports that were submitted with its application for Water Quality Certification and the report of waste discharge, as well as any engineering plans, specifications, and technical reports that are subsequently submitted to the Regional Water Board in order to comply with this Order.
35. The Discharger is considered to have full responsibility for correcting any and all problems that arise in the event of a failure that results in an unauthorized release of waste or wastewater.
36. The discharge of any hazardous, designated, or non-hazardous waste as defined in Title 23, Division 3, Chapter 15 of the California Administrative Code, shall be disposed of in accordance with applicable state and federal regulations.
37. The Discharger shall remove and relocate any wastes that are discharged at any sites in violation of this Order.
38. In accordance with Water Code §13260, the Discharger shall file with the Regional Water Board a report of any proposed change in ownership or any material change in the character, location, or quantity of this waste discharge. Any proposed material change in the discharge requires approval by the Regional Water Board after a hearing under Water Code §13263. Material change includes, but is not be limited to, all significant new soil disturbances, all proposed expansion of development, or any change in drainage characteristics at the Project Site. For the purpose of this Order, this includes any proposed change in the boundaries of the area of wetland/waters of the State to be filled and mitigated.
39. The following standard conditions apply to this Order:
 - a. Every certification action is subject to modification or revocation upon administrative or judicial review, including review and amendment pursuant to Water Code §13330 and 23 CCR §3867.
 - b. Certification is not intended and shall not be construed to apply to any activity involving a hydroelectric facility and requiring a Federal Energy Regulatory Commission (FERC) license or an amendment to a FERC license unless the pertinent certification application was filed pursuant to 23 CCR §3855(b) and that application specifically identified that a FERC license or amendment to a FERC license for a hydroelectric facility was being sought.

- c. Certification is conditioned upon total payment of any fee required pursuant to 23 CCR §3833 and owed by the Discharger.
40. The Discharger shall maintain a copy of this Order and all relevant plans and BMPs at the Project Site so as to be available at all times to site operating personnel and agencies.
41. The Discharger shall permit the Regional Water Board or its authorized representatives at all times, upon presentation of credentials:
 - a. Entry onto Project premises, including all areas on which water body fill or water body mitigation is located or in which records are kept.
 - b. Access to copy any records required to be kept under the terms and conditions of this Order.
 - c. Inspection of any treatment equipment, monitoring equipment, or monitoring method required by this Order.
 - d. Sampling of any discharge or surface water covered by this Order.
42. This Order does not authorize commission of any act causing injury to the property of another or of the public; does not convey any property rights; does not remove liability under federal, State, or local laws, regulations or rules of other programs and agencies, nor does this Order authorize the discharge of wastes without appropriate permits from other agencies or organizations.
43. The Regional Water Board will consider rescission of this Order upon Project completion and the Executive Officer's acceptance of notices of completion of mitigation for all mitigation, creation, and enhancement projects required or otherwise permitted now or subsequently under this Order.
44. This WDRs and Water Quality Certification is subject to modification or revocation upon administrative or judicial review, including review and amendment pursuant to Water Code section 13330 and 23 CCR §3867.
45. The Regional Water Board may add to or modify the conditions of this Order, as appropriate, to implement any new or revised water quality standards and implementation plans adopted or approved pursuant to the Porter-Cologne Water Quality Control Act or section 303 of the Clean Water Act.
46. This Order is not transferable.

I, Bruce H. Wolfe, Executive Officer, do hereby certify that the foregoing is a full, complete and correct copy of an Order adopted by the California Regional Water Quality Control Board, San Francisco Bay Region on January 21, 2015.



Digitally signed by Bruce H. Wolfe
DN: cn=Bruce H. Wolfe,
o=SWRCB, ou=Region 2,
email=bwolfe@waterboards.ca.gov,
c=US
Date: 2015.01.28 15:32:36 -08'00'

Bruce H. Wolfe
Executive Officer

Site No. 02-01-C1070
CIWQS Place ID Number 748052
CIWQS Regulatory Measure ID Number 394145
Corps File No. 29702S

Attachments:

- 1: Project Site Location, Existing Project Site Conditions, and Proposed Project Site Conditions
- 2: Project Phasing, Project Shoreline Improvement Designs, Construction Quantities Table, and Table of Permitted Fill Quantities
- 3: Post Construction Stormwater Treatment Measures for the Project Site
- 4: Groundwater and Soil Contamination Levels at the Project Site and Protocols for Discharging Contaminated Groundwater During Project Construction
- 5: Assessment of the Habitat Value of Pier Pilings (Zabin, 2011)

ATTACHMENT 1

**Waste Discharge Requirements
and
Water Quality Certification
Oak to Ninth Project
City of Oakland, Alameda County**

**Project Site Location, Existing Project Site Conditions,
and Proposed Project Site Conditions**



LSA

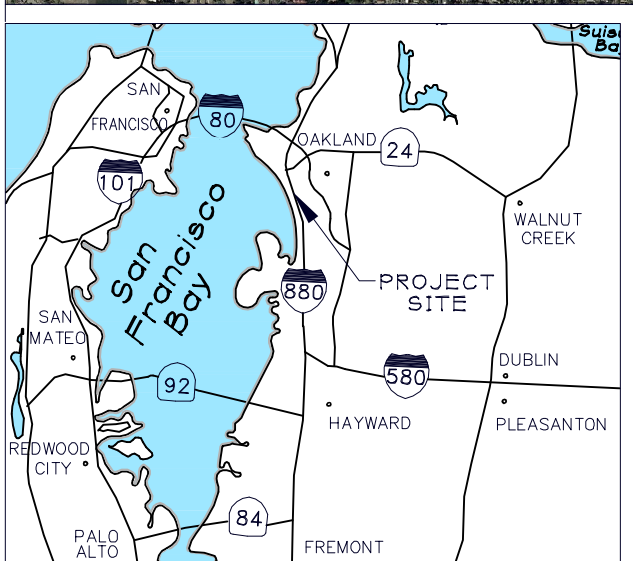
FIGURE 1



SOURCE: ©2006 DeLORME. STREET ATLAS USA©2006.

Oak to Ninth Avenue Project
 Alternatives Analysis
 Regional Location

OAK TO NINTH AVENUE PROJECT
401 WATER QUALITY CERTIFICATION



GRAPHIC SCALE

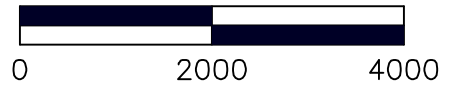


FIGURE 1: LOCATION MAP

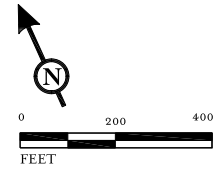


ENGINEERS / SURVEYORS / PLANNERS

255 SHORELINE DRIVE, SUITE 200
REDWOOD CITY, CA 94065
650/482-6300
650/482-6399 (FAX)



LSA



--- Approximate Project Boundary

SHORELINE HABITATS

- Eroding Fill
- xxxxx Rip-rap
- ==== Concrete Bank
- vvvvv Cordgrass Stand
- Sandy Shore
- ooooo Approximate Shoreline Under Pier

JURISDICTIONAL FEATURES

- Seasonal Pool
- >— Culvert
- Ditch

OTHER HABITAT TYPES *

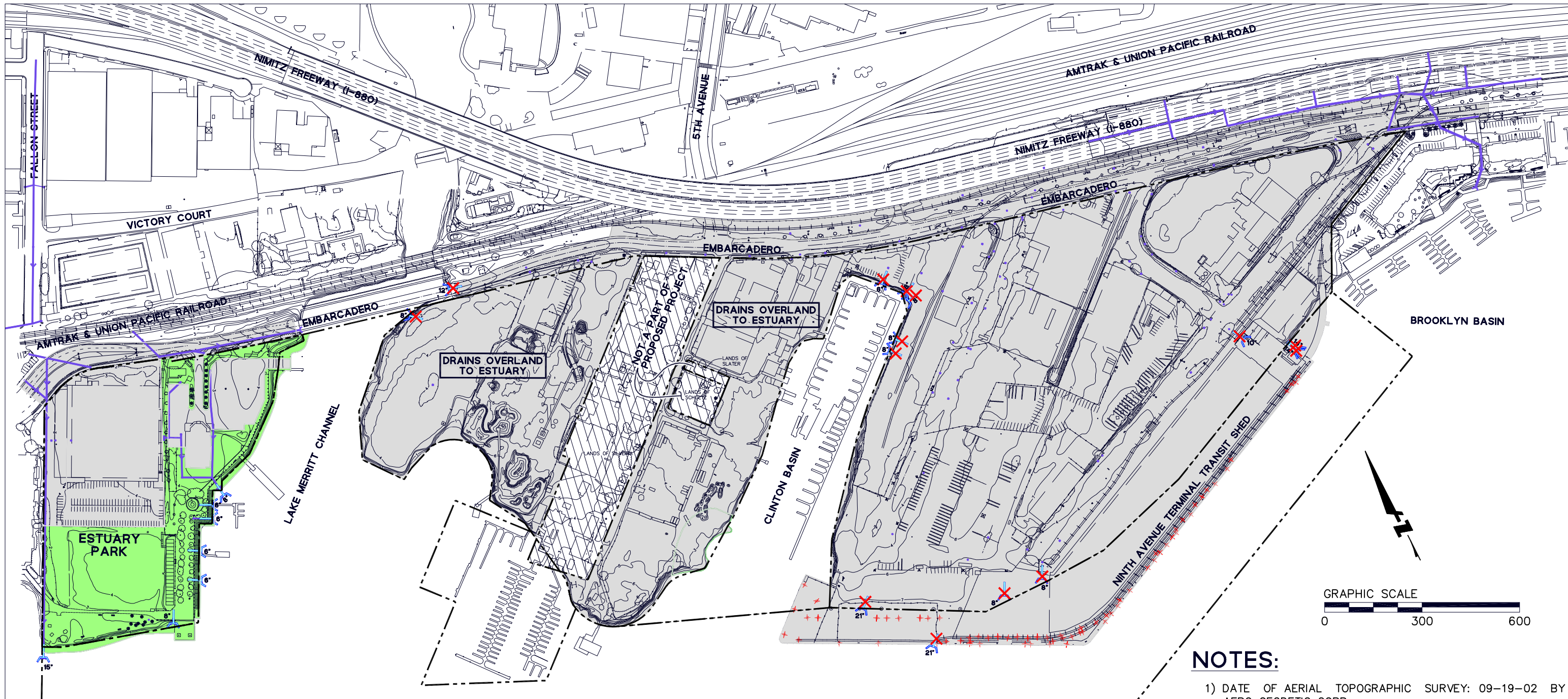
- ▨ Non-native Grassland or Ruderal
- ▤ Barren

* All Other Areas within the Project Boundary are Developed or Landscaped Areas.

FIGURE 3

*Oak to Ninth Avenue Project
Alternatives Analysis*

Existing Habitats and Jurisdictional Features



LEGEND

- EXISTING PERVIOUS AREA
- EXISTING IMPERVIOUS AREA
- EXISTING BOUNDARY
- OUTPARCELS
- EXISTING STORM DRAIN LINE
- EXISTING OUTFALLS (21 TOTAL)
- OPEN DRAIN OUTFALLS THROUGH PIER SURFACE TO ESTUARY (68 TOTAL)
- OUTFALL TO BE REMOVED



VIEW OF PIER SHOWING MULTIPLE OPEN DRAINS



OPEN DRAIN TROUGH PIER SURFACE TO ESTUARY



EXISTING OUTFALLS IN CLINTON BASIN

NOTES:

- 1) DATE OF AERIAL TOPOGRAPHIC SURVEY: 09-19-02 BY AERO GEODETIC CORP.
- 2) THE UTILITIES SHOWN ON THIS PLAN ARE DERIVED FROM RECORD DATA AND/OR SURFACE OBSERVATION AND ARE APPROXIMATE ONLY. ACTUAL LOCATION AND SIZE, TOGETHER WITH PRESENCE OF ANY ADDITIONAL UTILITY LINES NOT SHOWN ON THIS PLAN, SHALL BE VERIFIED IN THE FIELD BY THE CONTRACTOR DURING CONSTRUCTION.

**FIGURE 2 :
EXISTING CONDITION**

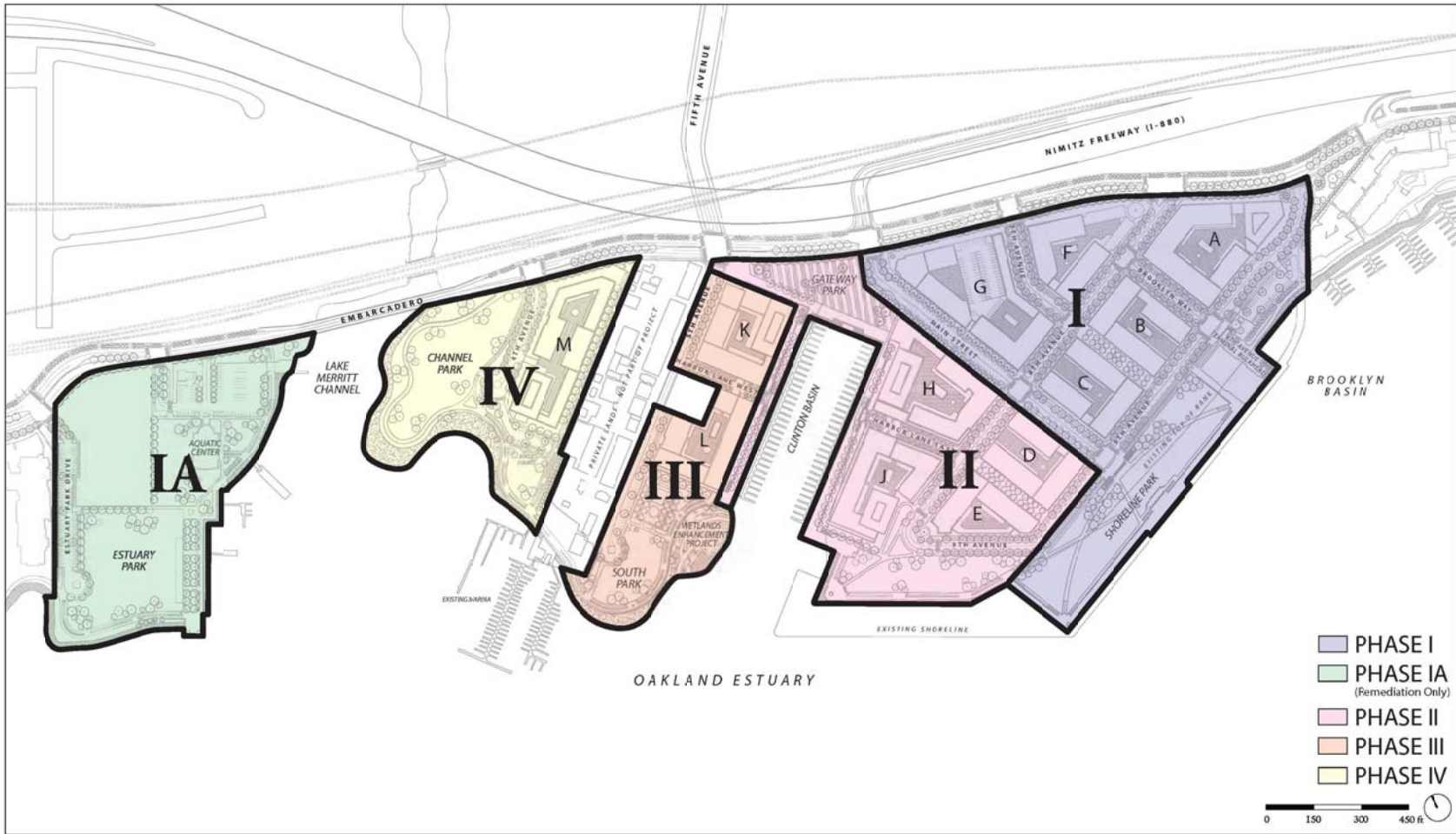


255 SHORELINE DRIVE
SUITE 200
REDWOOD CITY, CA 94065
650/482-6300
650/482-6399 (FAX)

ATTACHMENT 2

**Waste Discharge Requirements
and
Water Quality Certification
Oak to Ninth Project
City of Oakland, Alameda County**

**Project Phasing, Project Shoreline Improvement
Designs, Construction Quantities Table, and Table of
Permitted Fill Quantities**



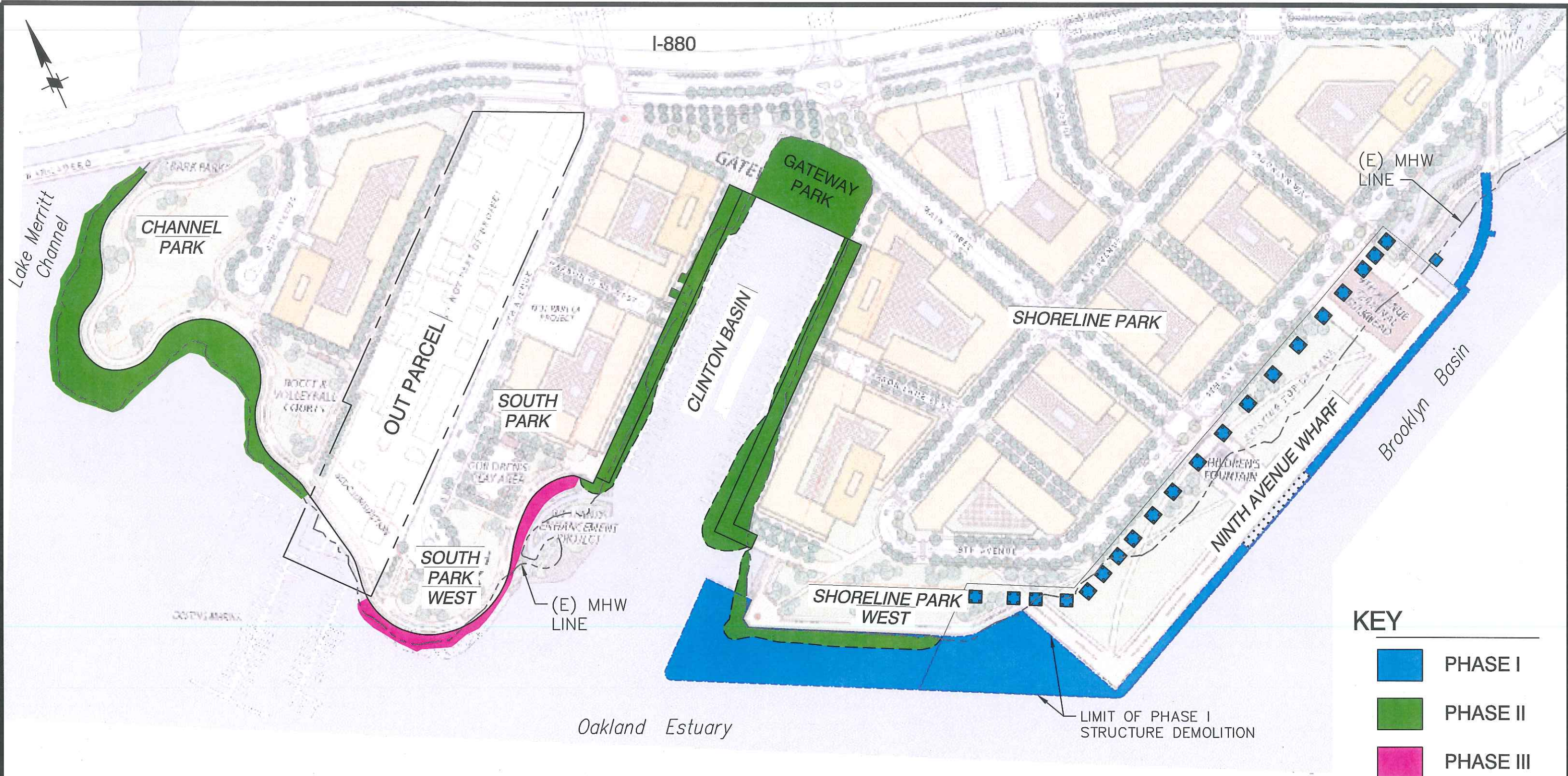
PHASING PLAN

Brooklyn Basin - Oak to 9th Development Plan

Prepared for Oakland Harbor Partners by ROMA Design Group in association with MVE Architects, Moffatt & Nichol and BKF Engineers

JUNE 2006

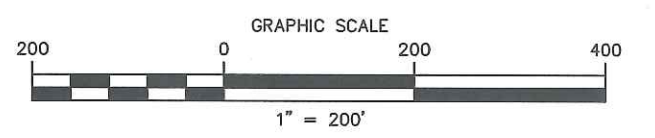
FIGURE 5



KEY

- PHASE I
- PHASE II
- PHASE III

SHORELINE IMPROVEMENTS PLAN




 MOFFATT & NICHOL WALNUT CREEK, CALIFORNIA	OAK TO NINTH DEVELOPMENT PROJECT
	SHORELINE IMPROVEMENTS
	SHORELINE PHASING

Table 9: Construction Quantities

SEGMENT	DESCRIPTION	UNIT	QUANTITY
Channel Park 0+00 to 12+00	Shoreline Debris Removal	LF	1,200
	Excavation/Dredging	CY	9,645 *
	Geomembrane	SY	4,000 *
	Filter Fabric	SY	4,000 *
	Articulating Concrete Block (ACB) Mats	SF	33,600 *
	Fill over ACB Mats	CY	1,717 *
South Park (West) 14+50 to 21+00	Shoreline Debris Removal	LF	700
	Excavation/Dredging	CY	1,753 *
	Geomembrane	SY	2,333 *
	Filter Fabric	SY	2,333 *
	Articulating Concrete Block (ACB) Mats	SF	19,600 *
	Fill over ACB Mats	CY	573 *
South Park (Clinton Basin) - West Side 21+80 to 28+50	Shoreline Debris Removal	LF	670
	Fill to Riprap Subgrade	CY	10 **
	Excavation/Dredging	CY	4,500 **
	Filter Fabric	SY	2,980 **
	Bedding	TON	0 **
	Armor Rock (200# Nominal)	TON	2,530 **
	Precast Concrete Piles 65' Long 18" square	EA	69
	Cast-in Place Concrete (Pile Caps)	CY	138
	Precast Bridge Planks	EA	176
	Precast Fascia Elements	EA	23
	Cast-in-Place Concrete (Deck & Curb)	CY	380
	Railing	LF	670
South Park (Clinton Basin) - North Side 28+50 to 30+90	Shoreline Debris Removal	LF	250
	Fill	CY	0 *
	Fill For Gateway Park (up to Finish Grade)	CY	22,400 **
	Steel Sheet Pile	SF	19,800 *
	Tieback Anchors	EA	31 *
	Concrete Sheet Pile Cap	CY	50 *
	Railing	LF	300

Table 9: Construction Quantities

SEGMENT	DESCRIPTION	UNIT	QUANTITY
South Park (Clinton Basin) - East Side			
30+90 to 38+00	Shoreline Debris Removal	LF	670
	Fill to Riprap Subgrade (or FG)	CY	5,500 **
	Excavation/Dredging	CY	3,500 **
	Filter Fabric	SY	3,000 **
	Bedding	TON	0 **
	Armor Rock (200# Nominal)	TON	2,540 **
	Precast Concrete Piles 65' long 18" Square	EA	75
	Cast-in-Place Concrete (Pile Caps)	CY	147
	Precast Bridge Planks	EA	192
	Precast Fascia Elements	EA	25
	Cast-in-Place Concrete (Deck & Curb)	CY	410
	Railing	LF	798
Shoreline Park (West)			
38+20 to 42+00	Bedding	TON	0 *
	Filter Fabric	SY	0 *
	Armor Rock (50# Nominal)	TON	890 *
Shoreline Park (Ninth Avenue Terminal Wharf)			
	Deck Demolition for Retrofit Pile Caps	SF	13,520
	Five Foot Diameter Retrofit Piles 100' Long	EA	80
	Cast-in-Place Concrete for Pile Caps	CY	3,004
	Seismic Joint	LF	40

* Revised December 2007

** Revised August 2010

Table 10: Permit Related Quantities

BAYFILL (As Defined By BCDC)

Reach	Begin	End	Length (ft)	Bayfill - Area (at MHW)*		
				Solid (sf)	Shaded (sf)	Floating (sf)
Channel Park	0+00	12+00	1,200	(28,060)	0	0
South Park (West)	14+50	21+00	650	(498)	0	0
South Park (Clinton Basin)	21+00	38+20	1,720	23,547 ***	36,570 ***	(5,800) ** †
Shoreline Park (West)	38+20	42+50	430	(1,300)	(69,500) ***	0
Shoreline Park (Ninth Avenue Wharf)	42+50	56+00	1,350	(1,200)	(64,750) ***	0
Total			5,350	(7,511) ***	(97,680) ***	(5,800) **

VOLUME OF FILL BELOW MHW

Reach	Begin	End	Length (ft)	Fill Volume (excludes revetment) (cy)	Revetment Volume (cy)
Channel Park	0+00	12+00	1,200	50 ***	20 ***
South Park (West)	14+50	21+00	650	150 ***	50 ***
South Park (Clinton Basin)	21+00	38+20	1,720	19,700 ***	3,000 ***
Shoreline Park (West)	38+20	42+50	430	0	600 ***
Shoreline Park (Ninth Avenue Wharf)	42+50	56+00	1,350	0	50 *** (outfall structure)
Total			5,350	19,900 ***	3,720 ***

VOLUME OF DREDGING

Reach	Begin	End	Length (ft)	Excavation Below MHW (cy)
Channel Park	0+00	12+00	1,200	1,400 ***
South Park (West)	14+50	21+00	650	700 ***
South Park (Clinton Basin) Shoreline Work Only	21+00	38+20	1,720	8,000 ***
Shoreline Park (West)	38+20	42+50	430	0
Shoreline Park (Ninth Avenue Wharf)	42+50	56+00	1,350	100 *** (outfall structure)
Total			5,350	10,200 **

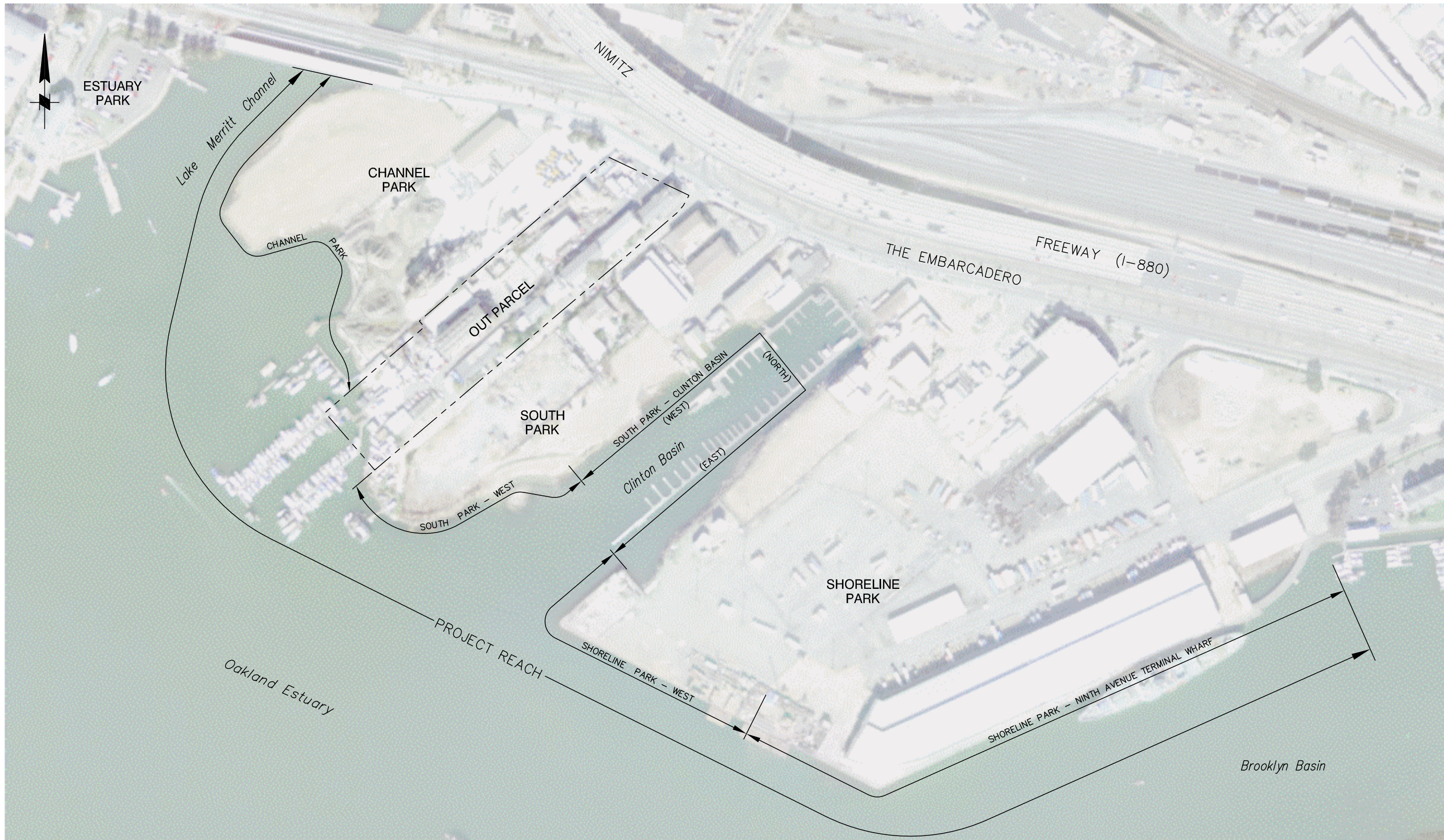
POTENTIAL HIGH MARSH HABITAT

Reach	Begin	End	Length (ft)	Area Between MTL and MHHW		
				Existing (sf)	Proposed (sf)	Change (sf)
Channel Park	0+00	12+00	1,200	14,185	50,119	35,934
South Park (West)	14+50	21+00	650	1,808	6,573	4,765
South Park (Clinton Basin) ††	21+00	38+20	1,720	n/a **	n/a **	n/a **
Shoreline Park (West)	38+20	42+50	430	-	-	
Shoreline Park (Ninth Avenue Wharf)	42+50	56+00	1,350	-	-	
Total			5,350	15,993 **	56,692 **	40,699 **

* area in parenthesis () denotes increase in Bay

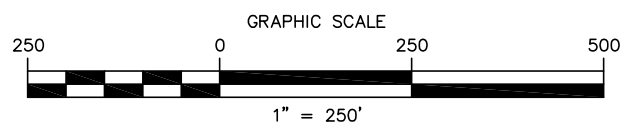
** Revised December 2007 *** Revised August 2010

†† No high marsh habitat exists in Clinton Basin and no high marsh habitat is proposed



SITE PLAN

SCALE: 1" = 250'

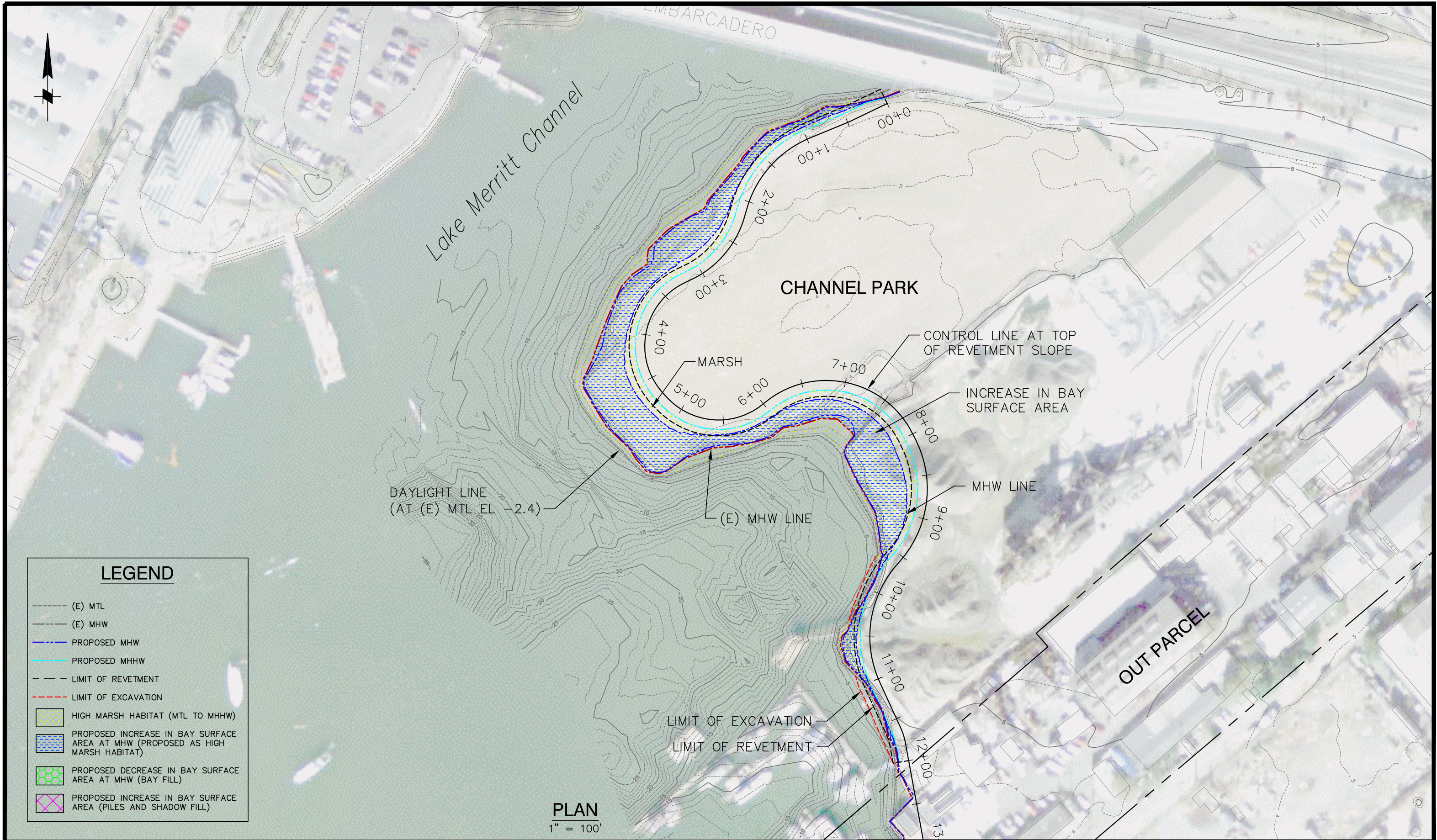


OAK TO NINTH DEVELOPMENT PROJECT

SHORELINE IMPROVEMENTS

SITE PLAN

FIGURE 1



LEGEND

- (E) MTL
- (E) MHW
- PROPOSED MHW
- PROPOSED MHHW
- LIMIT OF REVETMENT
- LIMIT OF EXCAVATION
- [Pattern] HIGH MARSH HABITAT (MTL TO MHHW)
- [Pattern] PROPOSED INCREASE IN BAY SURFACE AREA AT MHW (PROPOSED AS HIGH MARSH HABITAT)
- [Pattern] PROPOSED DECREASE IN BAY SURFACE AREA AT MHW (BAY FILL)
- [Pattern] PROPOSED INCREASE IN BAY SURFACE AREA (PILES AND SHADOW FILL)

PLAN
1" = 100'

GRAPHIC SCALE
100 0 100 200
1" = 100'

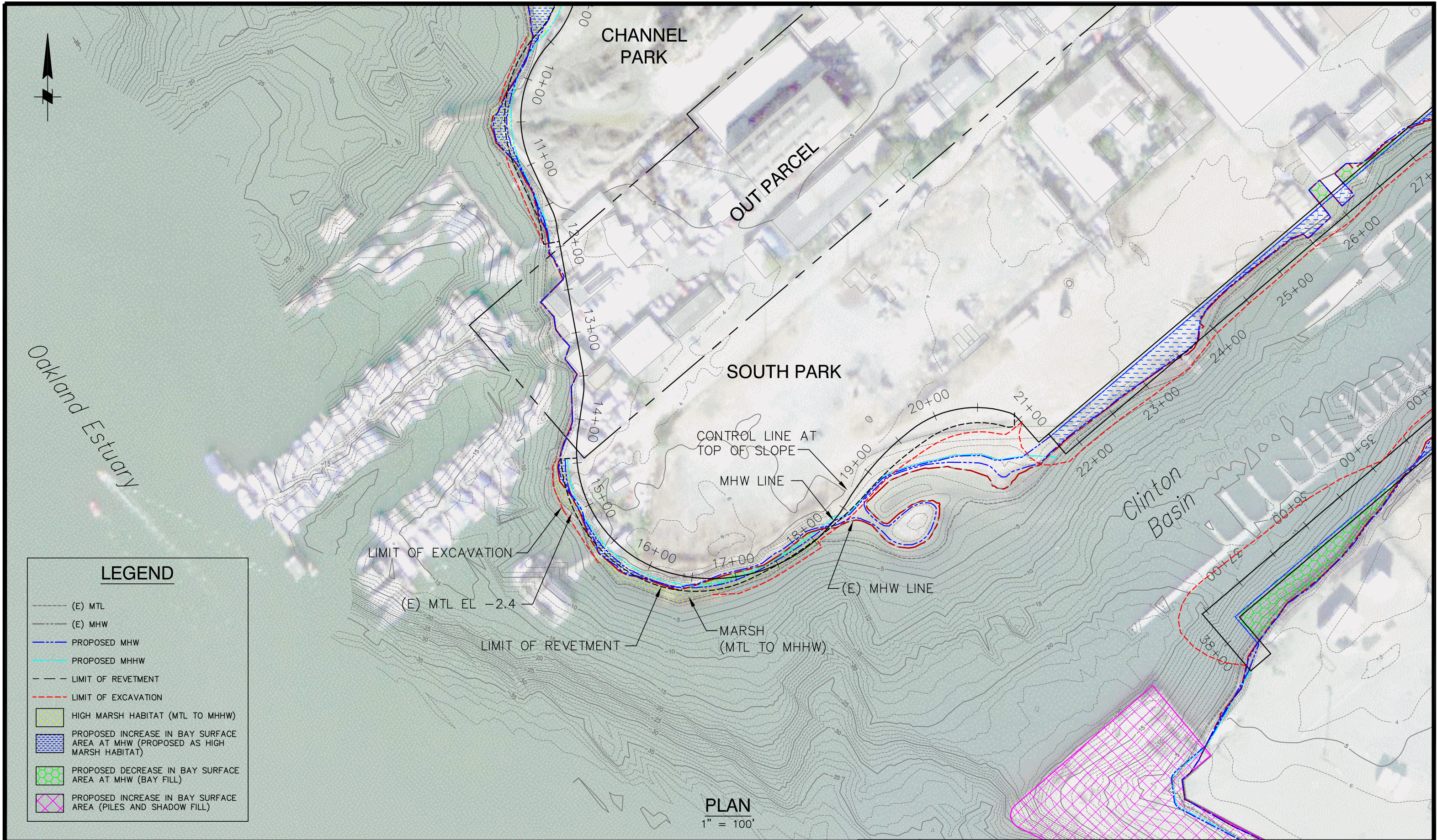
MOFFATT & NICHOL
WALNUT CREEK, CALIFORNIA

OAK TO NINTH DEVELOPMENT PROJECT

SHORELINE IMPROVEMENTS

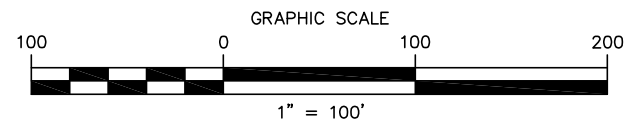
CHANNEL PARK

FIGURE 2



LEGEND

- (E) MTL
- (E) MHW
- PROPOSED MHW
- PROPOSED MHHW
- LIMIT OF REVETMENT
- LIMIT OF EXCAVATION
- [Green Hatched Box] HIGH MARSH HABITAT (MTL TO MHHW)
- [Blue Hatched Box] PROPOSED INCREASE IN BAY SURFACE AREA AT MHW (PROPOSED AS HIGH MARSH HABITAT)
- [Green Grid Box] PROPOSED DECREASE IN BAY SURFACE AREA AT MHW (BAY FILL)
- [Pink Grid Box] PROPOSED INCREASE IN BAY SURFACE AREA (PILES AND SHADOW FILL)



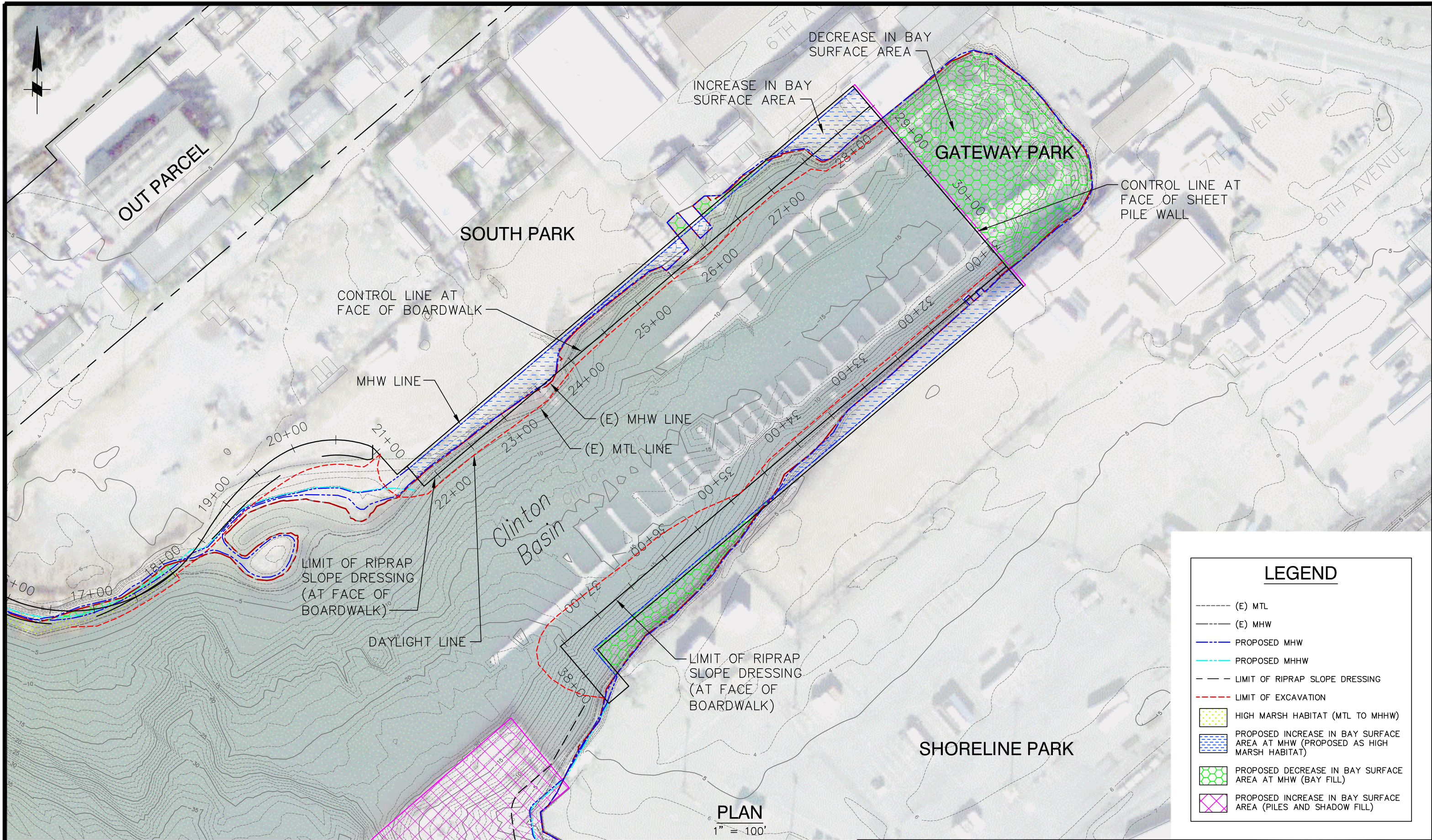
MOFFATT & NICHOL
WALNUT CREEK, CALIFORNIA

OAK TO NINTH DEVELOPMENT PROJECT

SHORELINE IMPROVEMENTS

SOUTH PARK - WEST

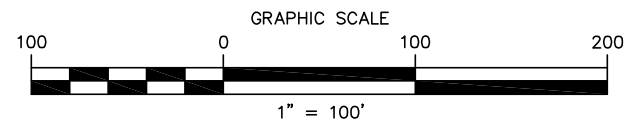
FIGURE 3



LEGEND

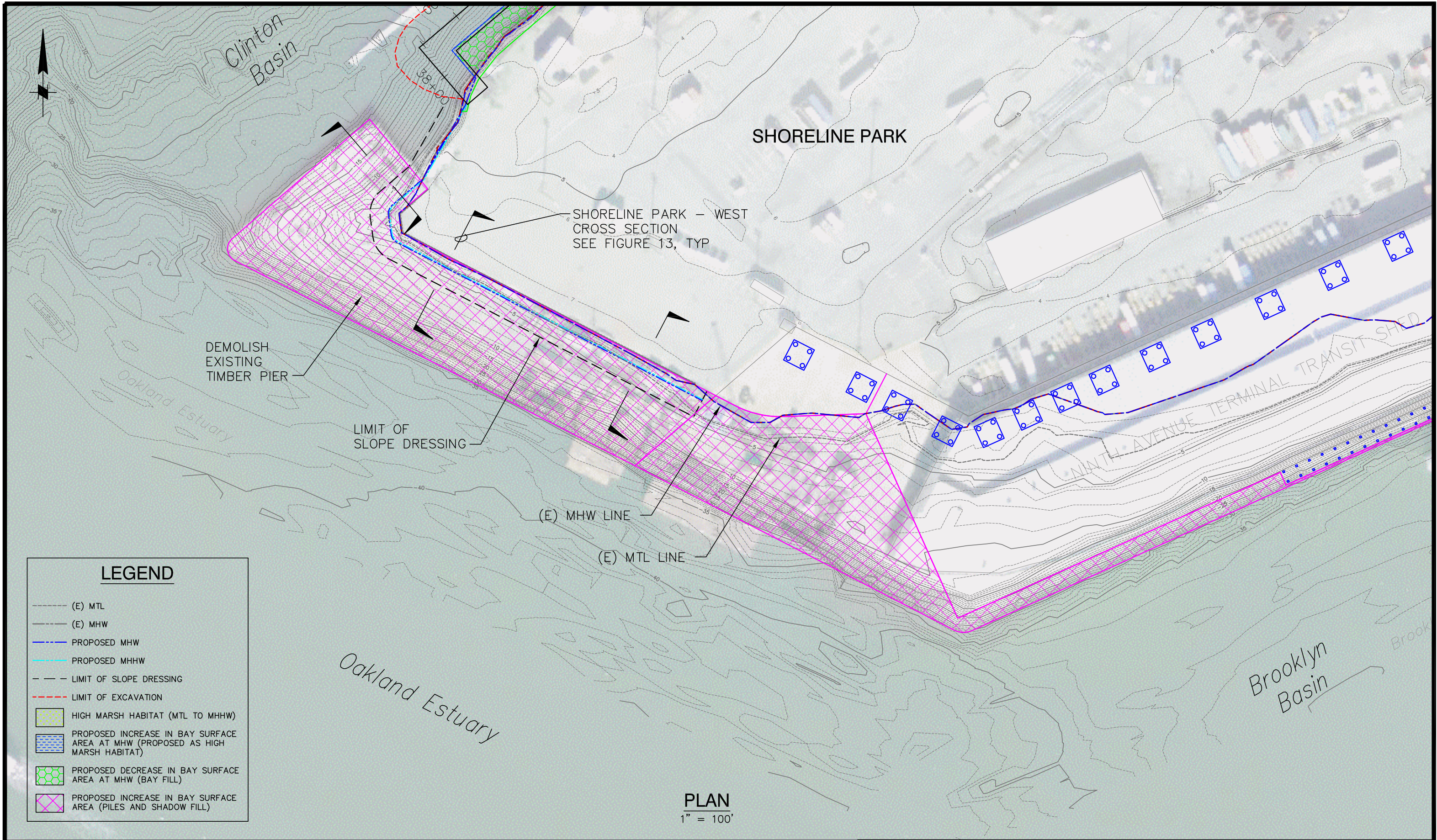
- (E) MTL
- (E) MHW
- PROPOSED MHW
- PROPOSED MHHW
- LIMIT OF RIPRAP SLOPE DRESSING
- LIMIT OF EXCAVATION
- [Green Hatched Box] HIGH MARSH HABITAT (MTL TO MHHW)
- [Blue Hatched Box] PROPOSED INCREASE IN BAY SURFACE AREA AT MHW (PROPOSED AS HIGH MARSH HABITAT)
- [Green Hatched Box] PROPOSED DECREASE IN BAY SURFACE AREA AT MHW (BAY FILL)
- [Pink Hatched Box] PROPOSED INCREASE IN BAY SURFACE AREA (PILES AND SHADOW FILL)

PLAN
1" = 100'



OAK TO NINTH DEVELOPMENT PROJECT
SHORELINE IMPROVEMENTS
SOUTH PARK - CLINTON BASIN

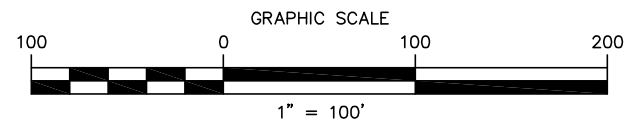
FIGURE
4



LEGEND

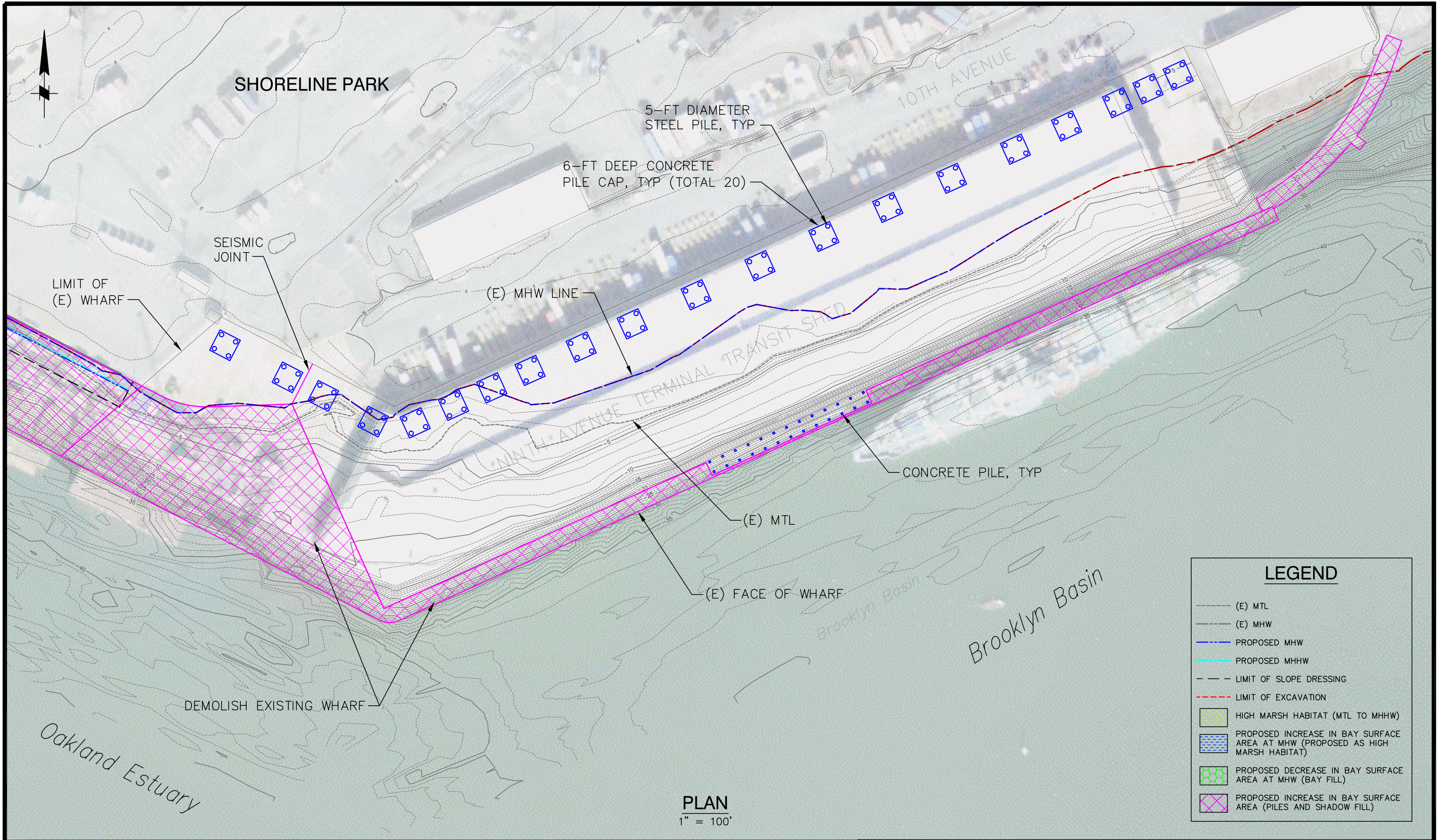
- (E) MTL
- (E) MHW
- PROPOSED MHW
- PROPOSED MHHW
- LIMIT OF SLOPE DRESSING
- LIMIT OF EXCAVATION
- [Green Hatched Box] HIGH MARSH HABITAT (MTL TO MHHW)
- [Blue Hatched Box] PROPOSED INCREASE IN BAY SURFACE AREA AT MHW (PROPOSED AS HIGH MARSH HABITAT)
- [Green Hatched Box] PROPOSED DECREASE IN BAY SURFACE AREA AT MHW (BAY FILL)
- [Pink Cross-hatched Box] PROPOSED INCREASE IN BAY SURFACE AREA (PILES AND SHADOW FILL)

PLAN
1" = 100'



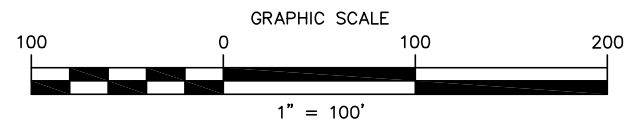
OAK TO NINTH DEVELOPMENT PROJECT
SHORELINE IMPROVEMENTS
SHORELINE PARK - WEST

FIGURE
5



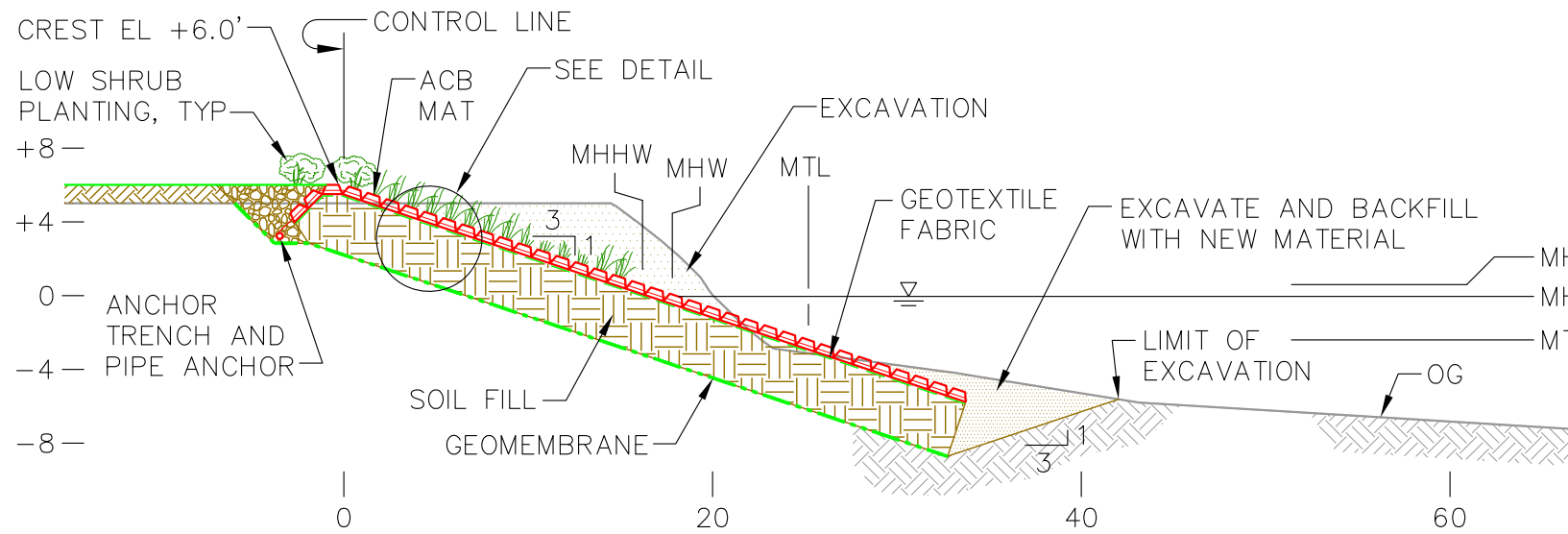
PLAN
1" = 100'

LEGEND	
--- (E) MTL	(E) MTL
--- (E) MHW	(E) MHW
--- PROPOSED MHW	PROPOSED MHW
--- PROPOSED MHHW	PROPOSED MHHW
--- LIMIT OF SLOPE DRESSING	LIMIT OF SLOPE DRESSING
--- LIMIT OF EXCAVATION	LIMIT OF EXCAVATION
[Green cross-hatch pattern]	HIGH MARSH HABITAT (MTL TO MHHW)
[Blue hatched pattern]	PROPOSED INCREASE IN BAY SURFACE AREA AT MHW (PROPOSED AS HIGH MARSH HABITAT)
[Green hatched pattern]	PROPOSED DECREASE IN BAY SURFACE AREA AT MHW (BAY FILL)
[Pink cross-hatch pattern]	PROPOSED INCREASE IN BAY SURFACE AREA (PILES AND SHADOW FILL)

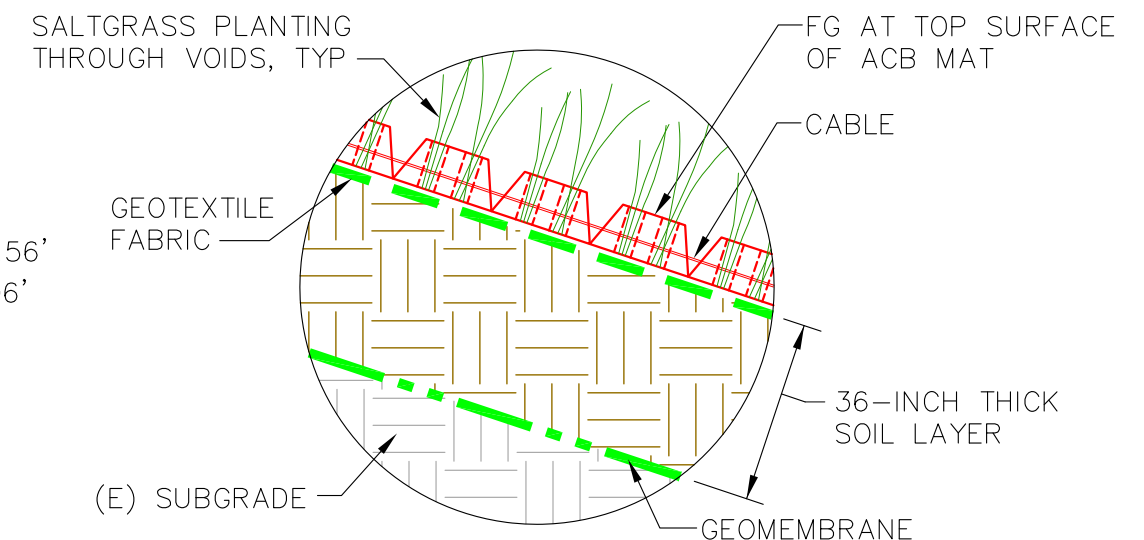


OAK TO NINTH DEVELOPMENT PROJECT
SHORELINE IMPROVEMENTS
NINTH AVENUE WHARF

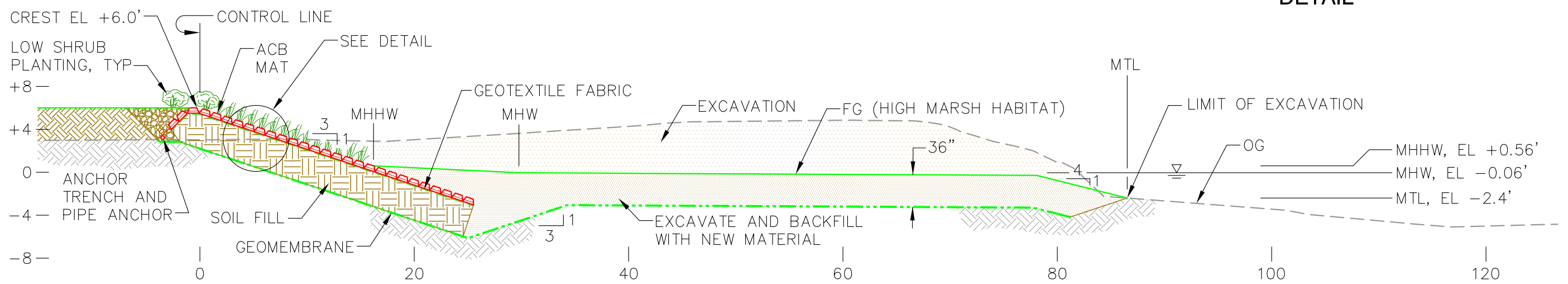
FIGURE 6



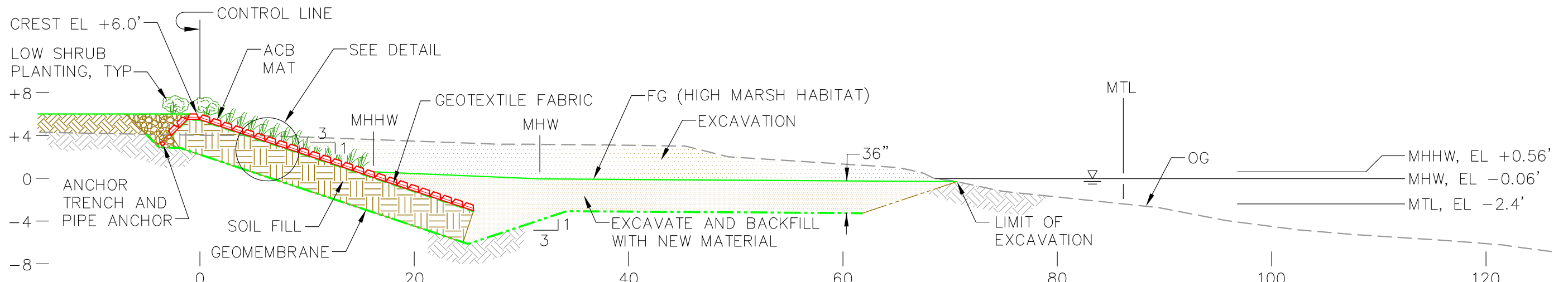
CHANNEL PARK - NEAR DOCKS



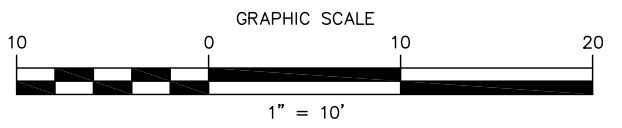
**TYPICAL SECTION
DETAIL**




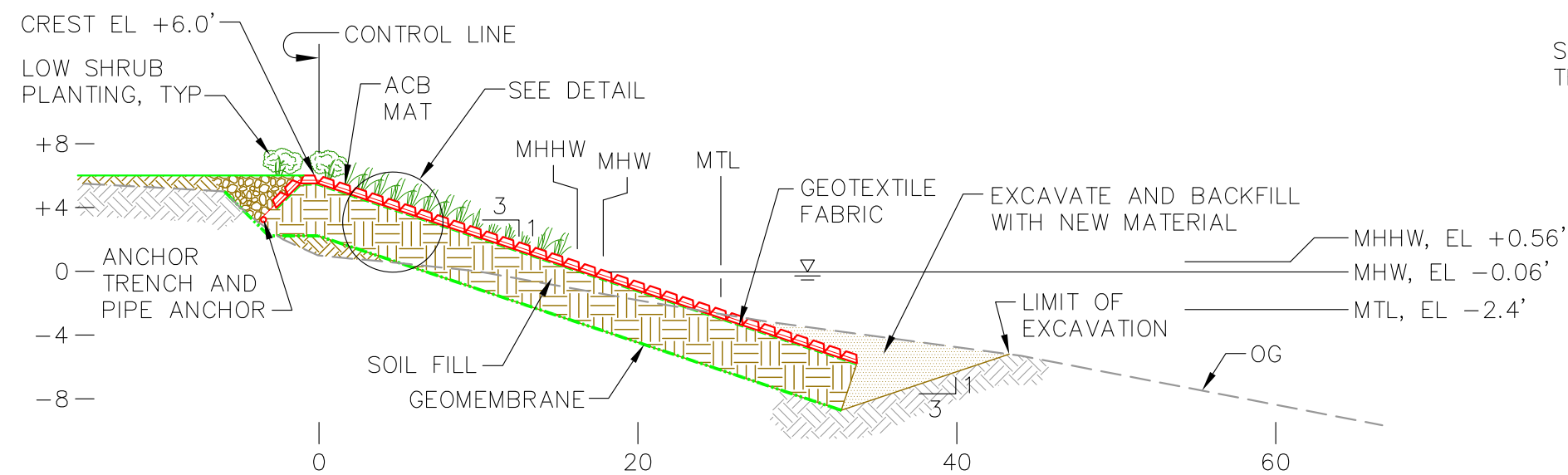
CHANNEL PARK - ALONG ESTUARY



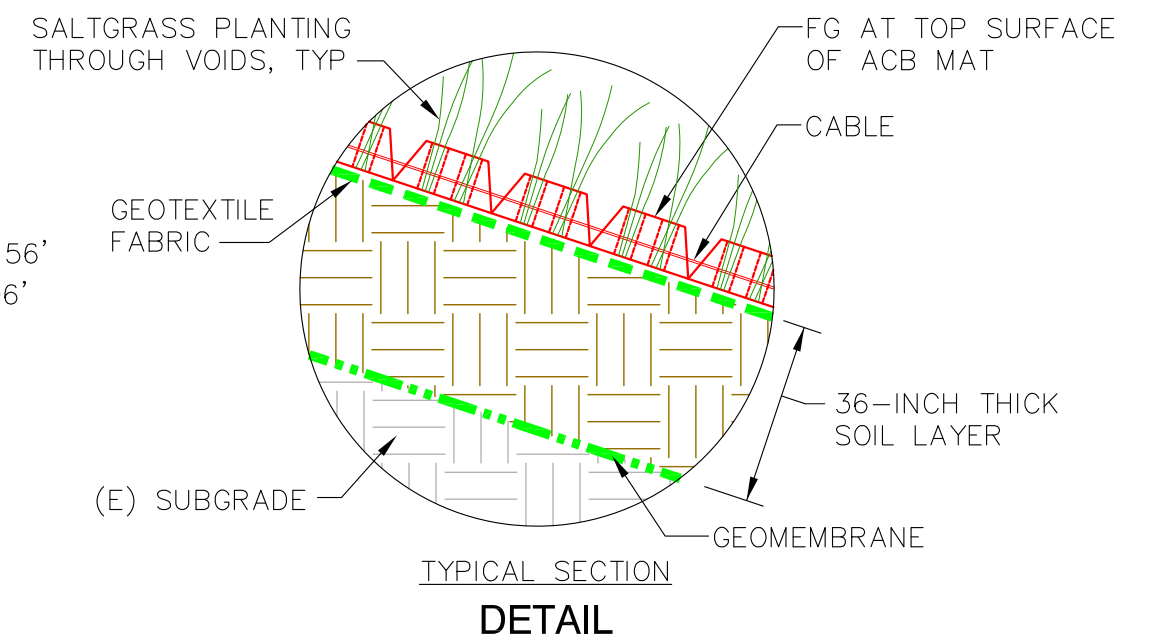
CHANNEL PARK - ALONG MERRITT CHANNEL



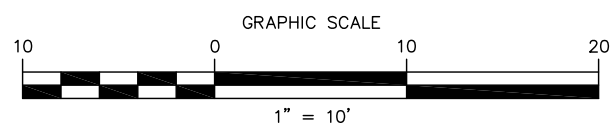
 <p>MOFFATT & NICHOL WALNUT CREEK, CALIFORNIA</p>	OAK TO NINTH DEVELOPMENT PROJECT	FIGURE 7
	SHORELINE IMPROVEMENTS	
	CHANNEL PARK - TYPICAL CROSS SECTIONS	




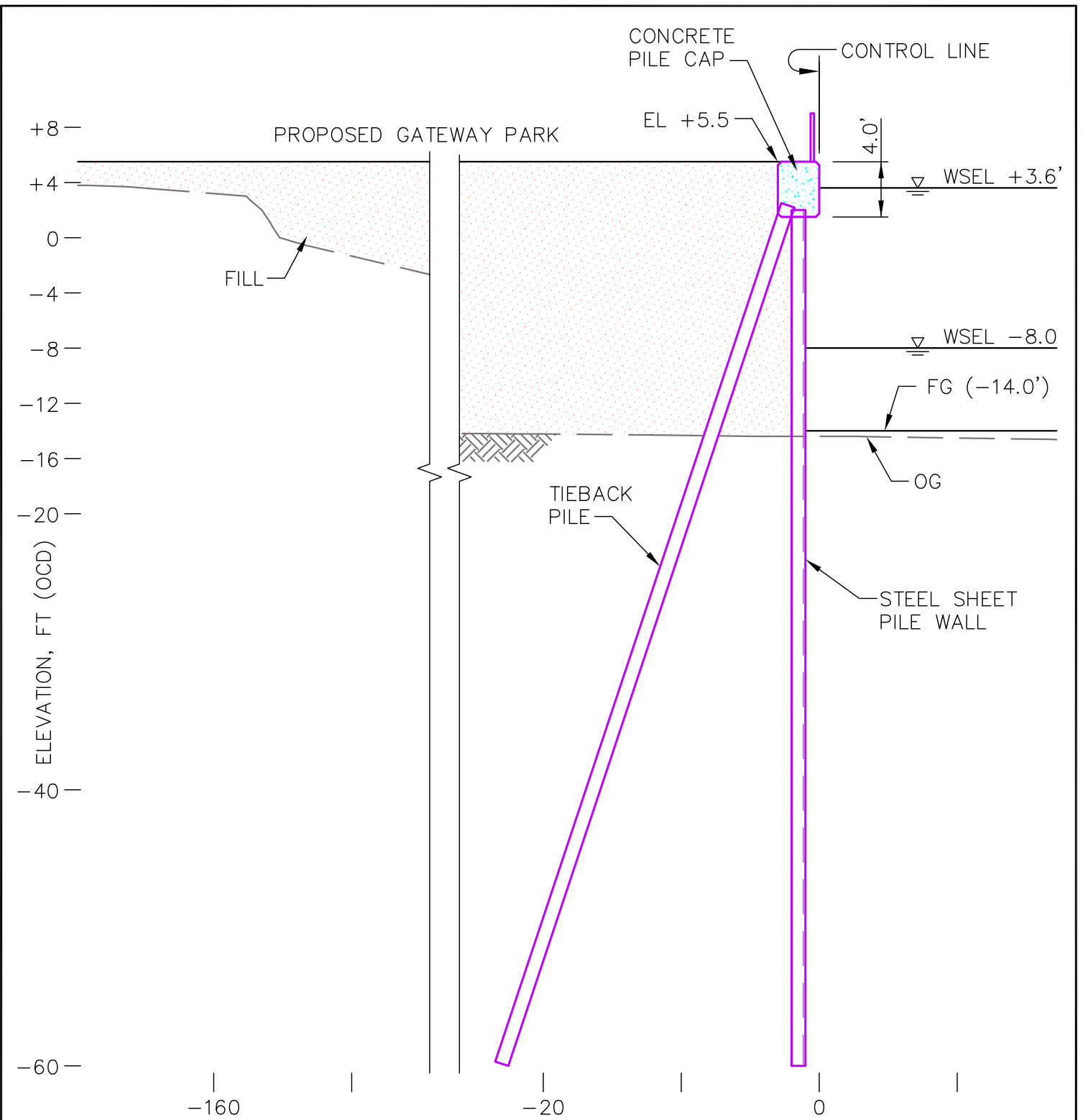
SOUTH PARK (WEST) - TYPICAL SECTION



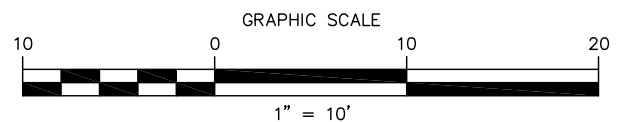
TYPICAL SECTION
DETAIL

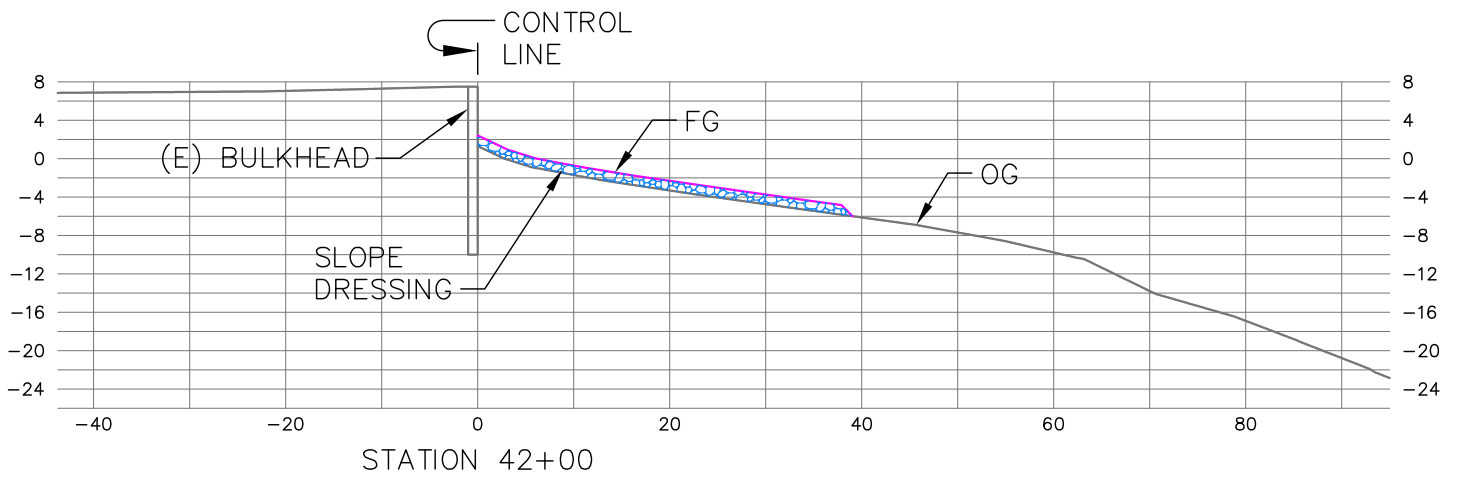


 WALNUT CREEK, CALIFORNIA	OAK TO NINTH DEVELOPMENT PROJECT	FIGURE 8
	SHORELINE IMPROVEMENTS	
	SOUTH PARK (WEST) - TYPICAL CROSS SECTION	

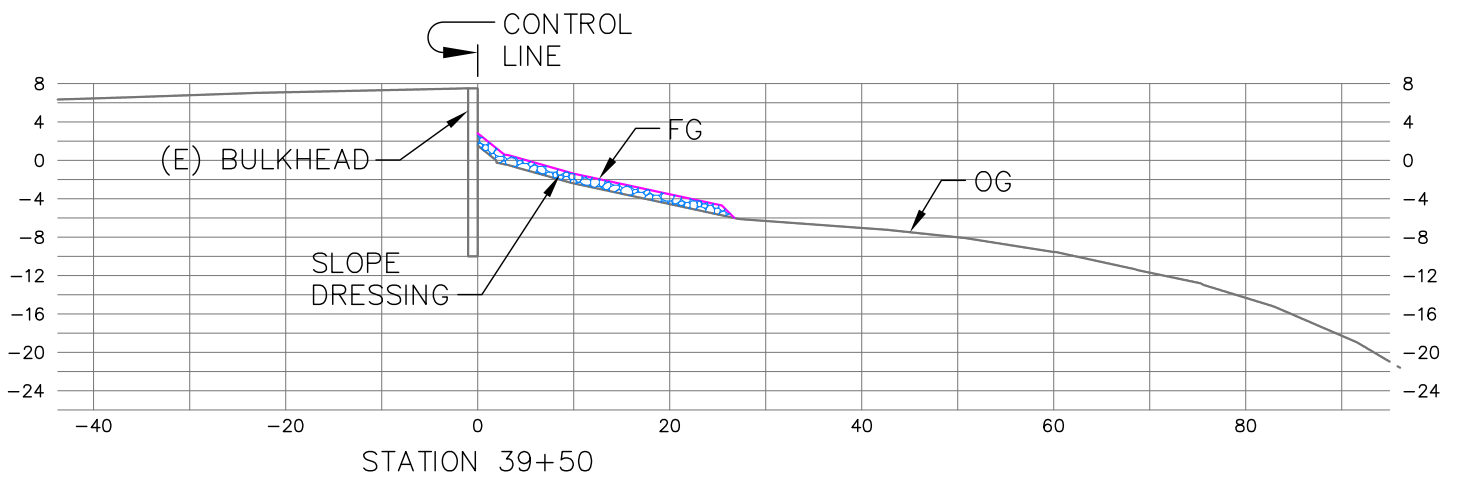


**ALTERNATIVE 1 - VERTICAL SHEET PILE BULKHEAD
(STEEL SHEET PILE OPTION SHOWN - NORTH SEGMENT ONLY)**

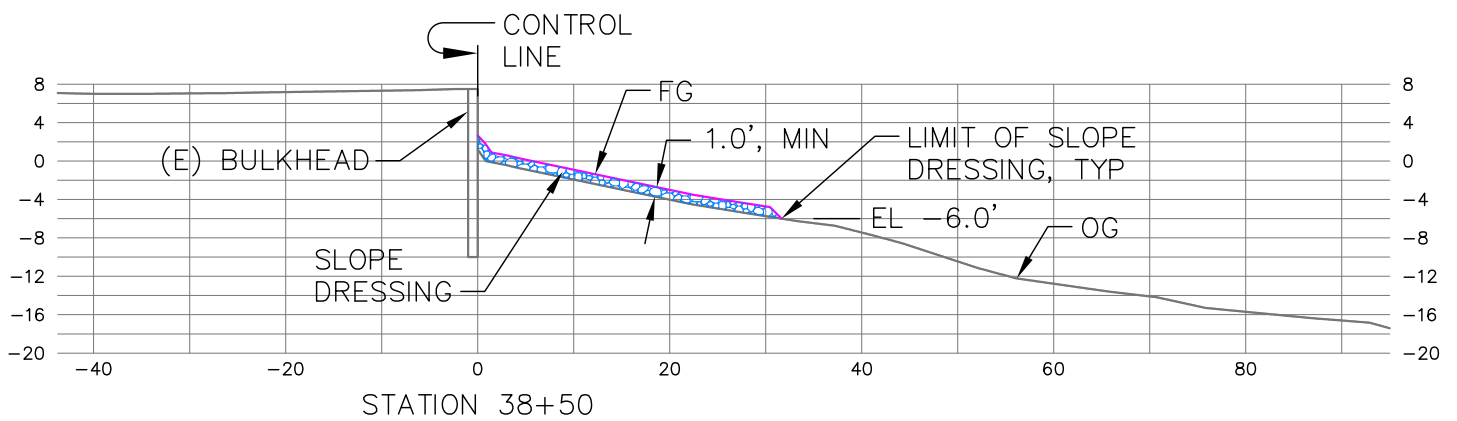




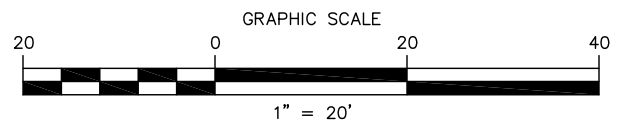
SHORELINE PARK - WEST



SHORELINE PARK - WEST



SHORELINE PARK - WEST



OAK TO NINTH DEVELOPMENT PROJECT

SHORELINE IMPROVEMENTS

**SHORELINE PARK - WEST
TYPICAL CROSS SECTIONS**

**FIGURE
13**




KEY

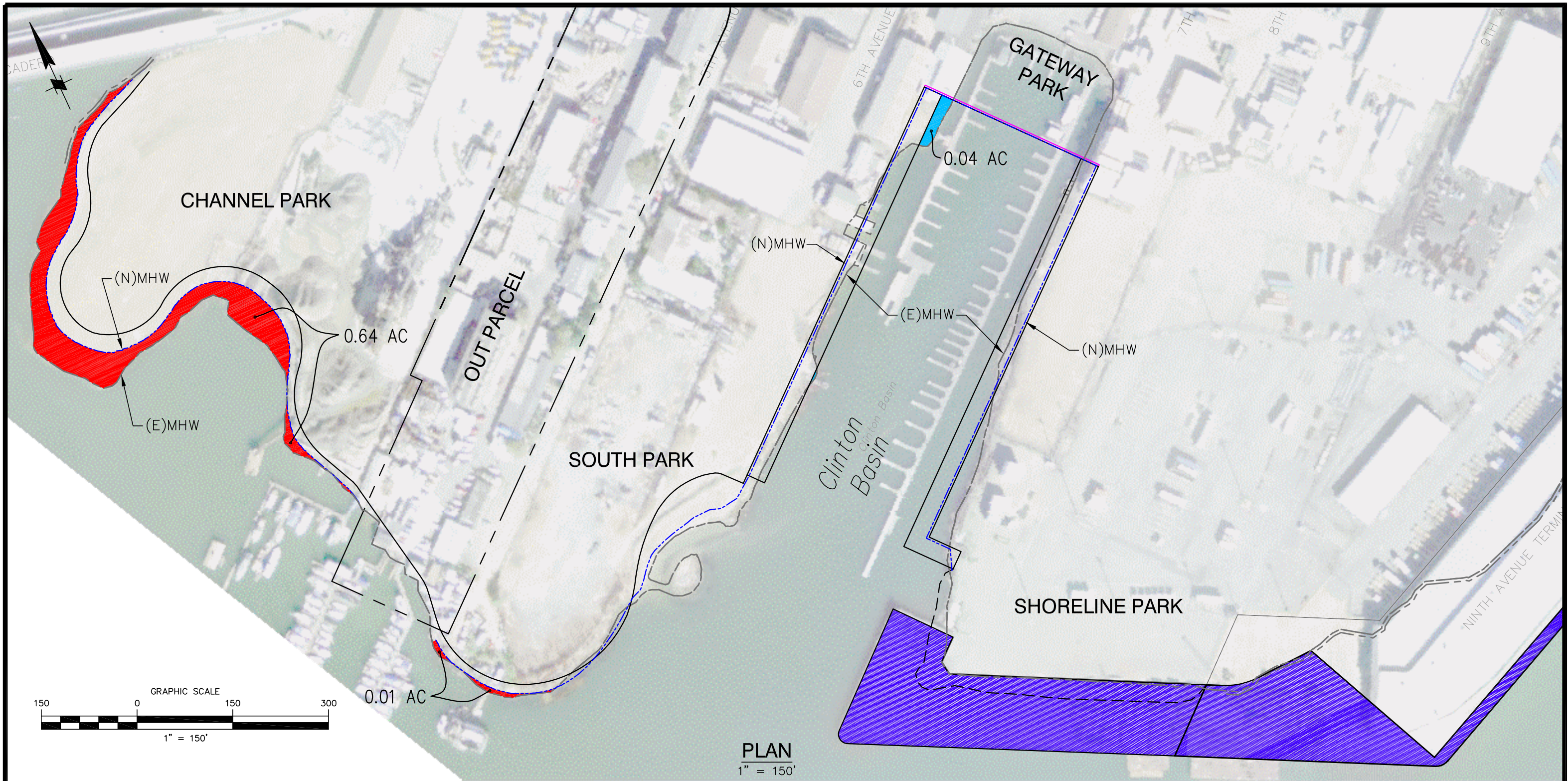
- IMPACT: (E) BAY BOTTOM TO BECOME UPLAND = 0.92 AC
- IMPACT: (E) BAY BOTTOM TO BECOME REVETMENT = 0.92 AC
- DEDUCT: AREA OF (E) REVETMENT = (0.50 AC)

TOTAL BAY BOTTOM IMPACT = 1.34 AC

* ESTIMATED AREA OF (E) RIPRAP ALONG CLINTON BASIN

IMPACTS (AT BAY BOTTOM)

 MOFFATT & NICHOL WALNUT CREEK, CALIFORNIA	OAK TO NINTH DEVELOPMENT PROJECT	FIGURE 1
	SHORELINE IMPROVEMENTS	
	SOUTH PARK - CLINTON BASIN SURFACE AREA AFFECTED (AT BAY BOTTOM)	

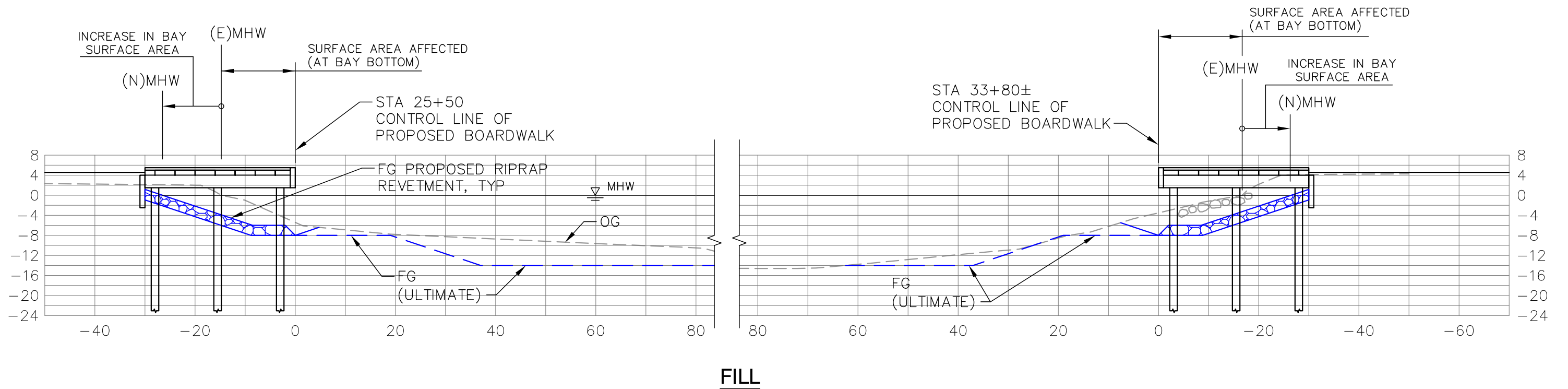
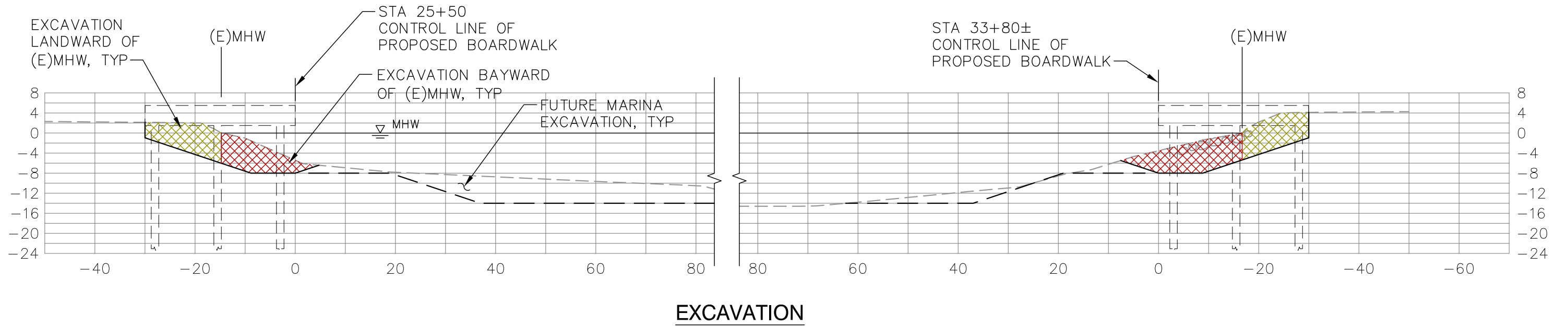


KEY

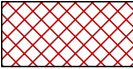

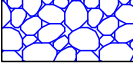
- MITIGATION: (E) UPLAND TO BECOME NATURAL SUBSTRATE = 0.04 AC
- MITIGATION: (E) UPLAND TO BECOME TIDAL MARSH = 0.65 AC
- MITIGATION: REMOVE (E) SHADOW FILL = 2.14 AC (NET)


MITIGATION (AT BAY BOTTOM)

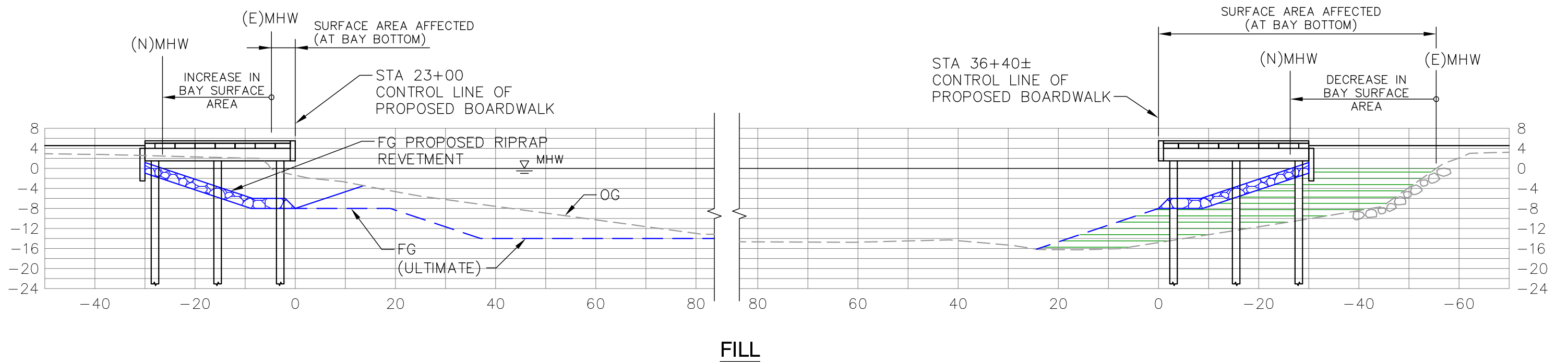
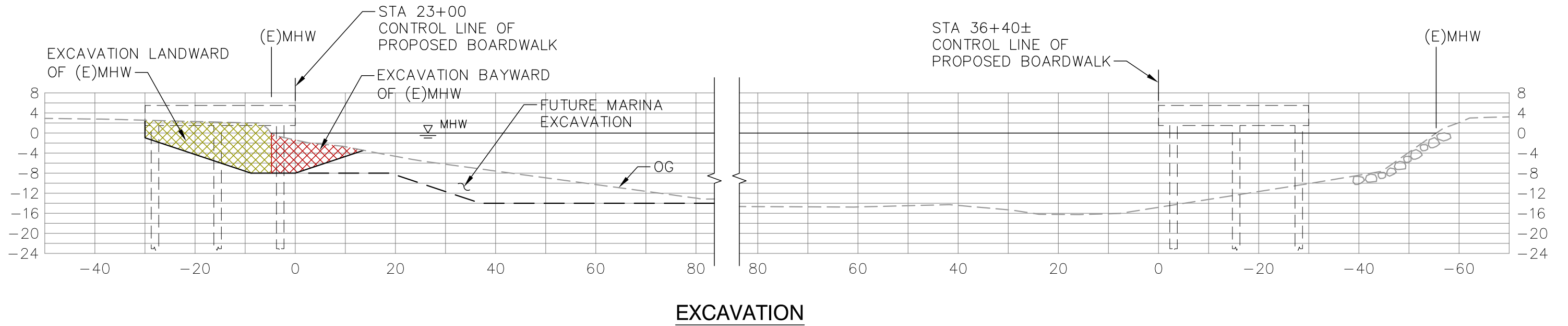
<p>MOFFATT & NICHOL WALNUT CREEK, CALIFORNIA</p>	OAK TO NINTH DEVELOPMENT PROJECT	FIGURE 2
	SHORELINE IMPROVEMENTS	
	SOUTH PARK - CLINTON BASIN SURFACE AREA AFFECTED (AT BAY BOTTOM)	



SECTION A-A
CLINTON BASIN - STA 25+50 (NORTH) & STA 33+80 (SOUTH)

- KEY**
-  EXCAVATION BAYWARD OF (E)MHW
 -  EXCAVATION LANDWARD OF (E)MHW
 -  NEW RIPRAP REVETMENT

 WALNUT CREEK, CALIFORNIA	OAK TO NINTH DEVELOPMENT PROJECT	FIGURE 3A
	SHORELINE IMPROVEMENTS	
	SOUTH PARK - CLINTON BASIN	

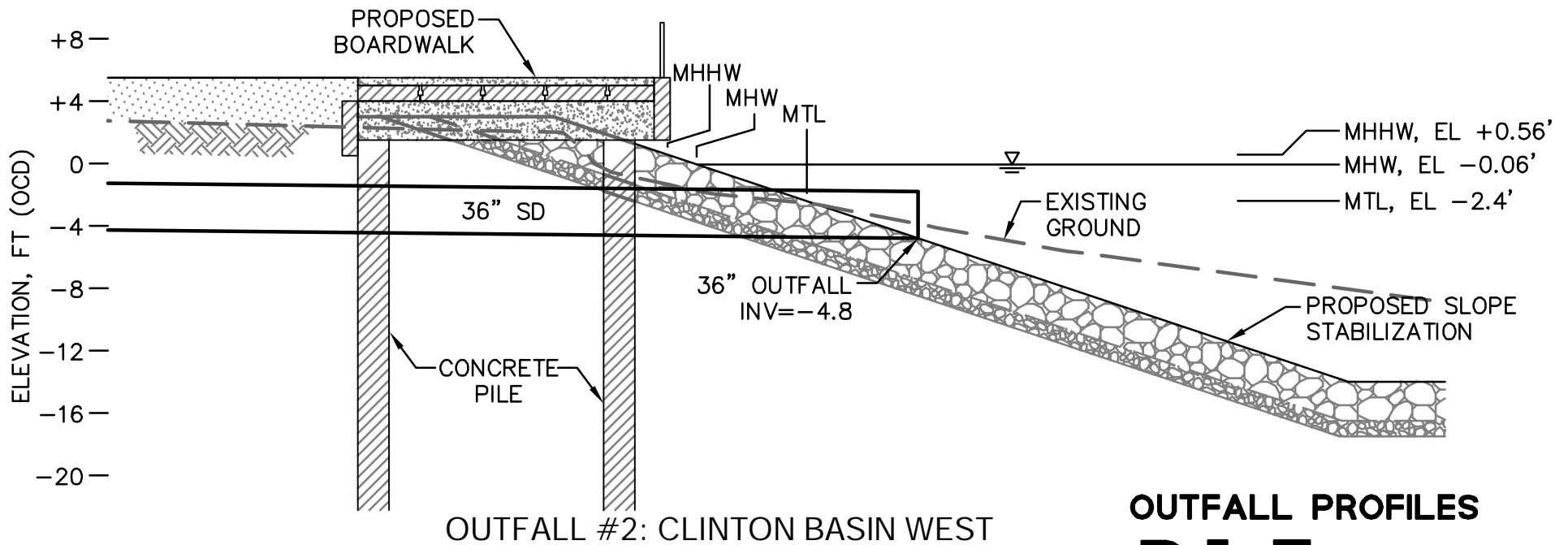
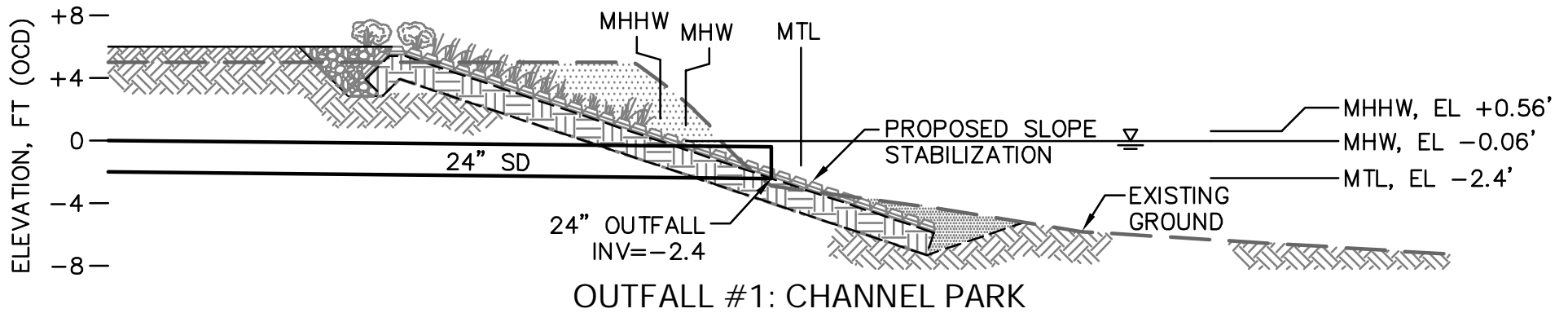


SECTION B-B
CLINTON BASIN - STA 23+00 (NORTH) & STA 36+40 (SOUTH)

KEY

- EXCAVATION BAYWARD OF (E)MHW
- EXCAVATION LANDWARD OF (E)MHW
- CLEAN FILL BAYWARD OF (E)MHW
- NEW RIPRAP REVETMENT

MOFFATT & NICHOL <small>WALNUT CREEK, CALIFORNIA</small>	OAK TO NINTH DEVELOPMENT PROJECT	FIGURE 3B
	SHORELINE IMPROVEMENTS	
	SOUTH PARK - CLINTON BASIN	



NOTE: FOR DETAIL OF SHORELINE IMPROVEMENTS REFER TO "OAK TO NINTH AVENUE DEVELOPMENT PROPOSED SHORELINE IMPROVEMENTS" OCTOBER 2006, ERATTA DECEMBER 6, 2007.



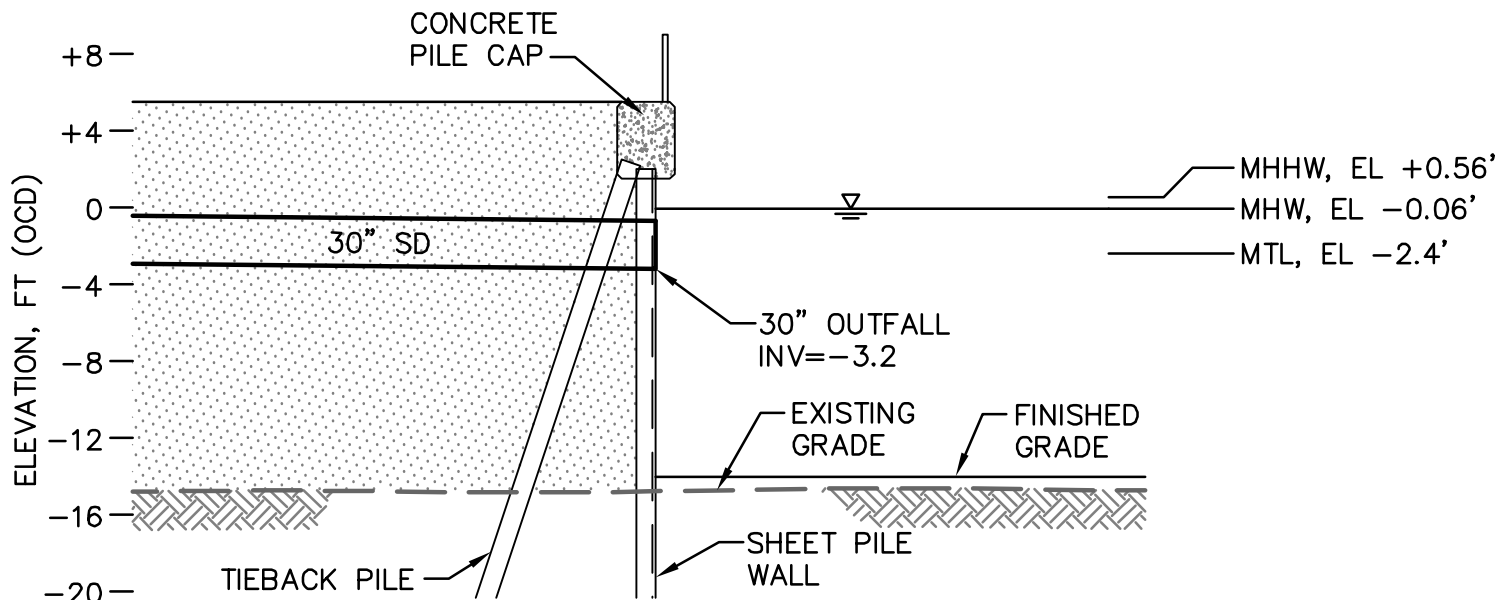
OUTFALL PROFILES



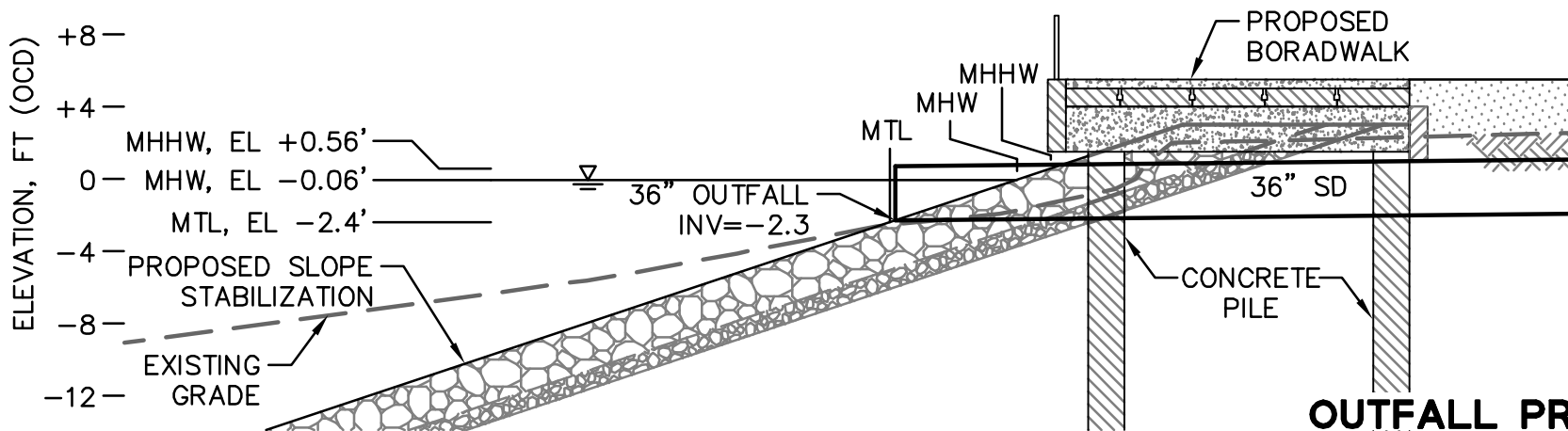
BKF
ENGINEERS / SURVEYORS / PLANNERS

255 SHORELINE DRIVE
SUITE 200
REDWOOD CITY, CA 94065
650/482-6300
650/482-6399 (FAX)

FIGURE 4A



OUTFALL #3: CLINTON BASIN NORTH



OUTFALL #4: CLINTON BASIN EAST

NOTE: FOR DETAIL OF SHORELINE IMPROVEMENTS REFER TO "OAK TO NINTH AVENUE DEVELOPMENT PROPOSED SHORELINE IMPROVEMENTS" OCTOBER 2006, ERATTA DECEMBER 6, 2007.

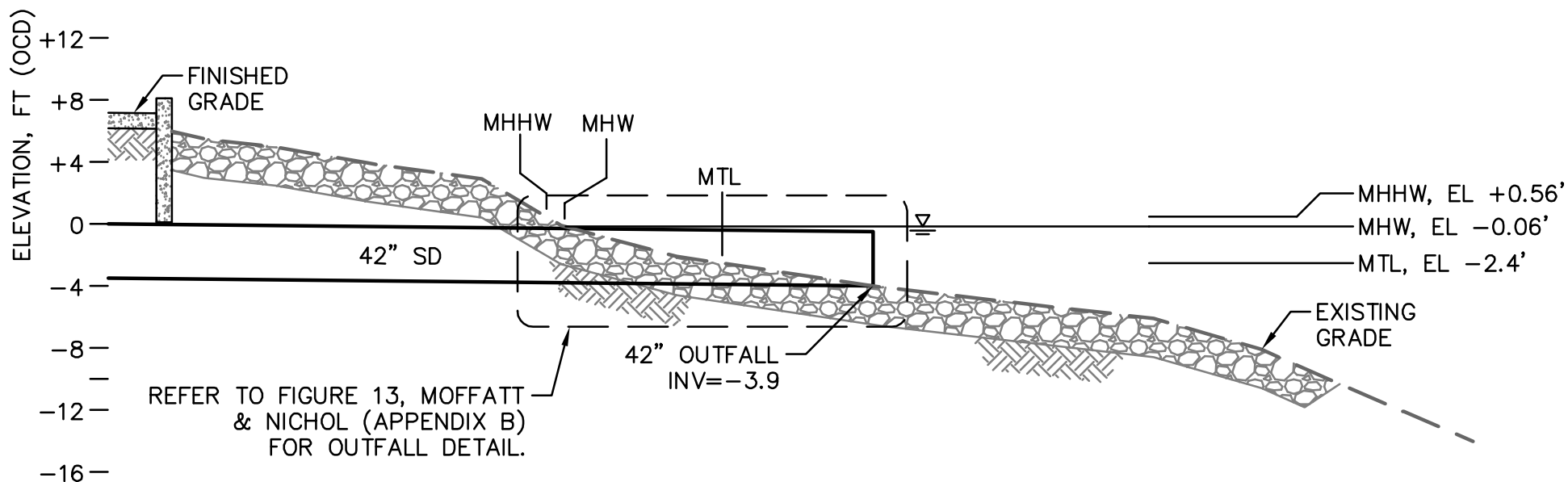
OUTFALL PROFILES



255 SHORELINE DRIVE
 SUITE 200
 REDWOOD CITY, CA 94065
 650/482-6300
 650/482-6399 (FAX)



FIGURE 4B



OUTFALL #5: SHORELINE PARK

NOTE: FOR DETAIL OF SHORELINE IMPROVEMENTS REFER TO "OAK TO NINTH AVENUE DEVELOPMENT PROPOSED SHORELINE IMPROVEMENTS" OCTOBER 2006, ERATTA DECEMBER 6, 2007.

OUTFALL PROFILES



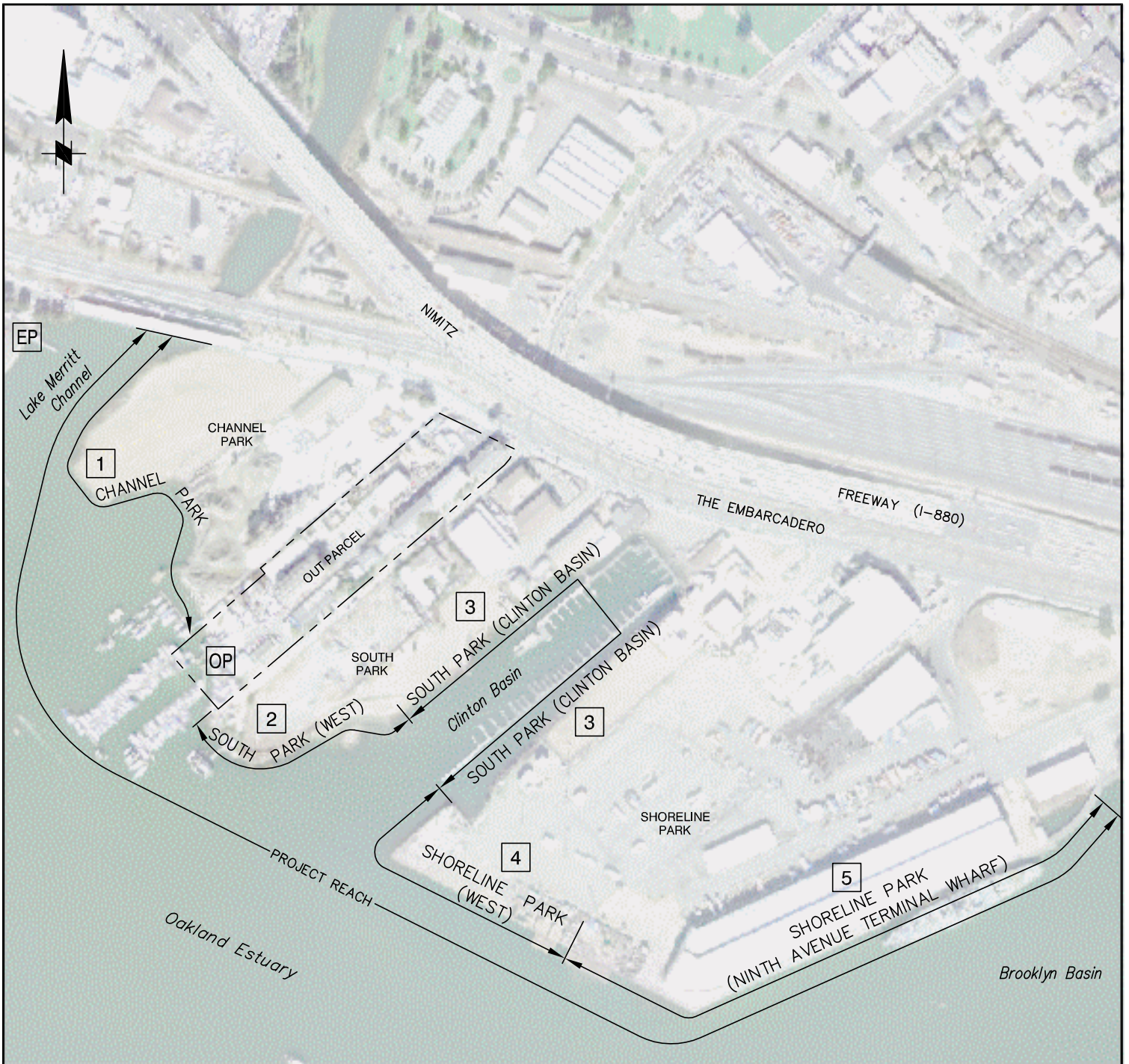
ENGINEERS / SURVEYORS / PLANNERS

255 SHORELINE DRIVE
SUITE 200
REDWOOD CITY, CA 94065
650/482-6300
650/482-6399 (FAX)

GRAPHIC SCALE

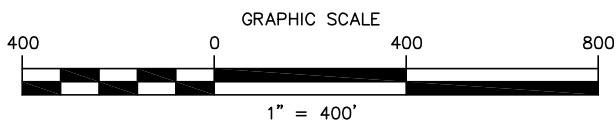


FIGURE 4C



SHORELINE LOCATION MAP

SCALE: 1" = 400'



 **MOFFATT & NICHOL**
WALNUT CREEK, CALIFORNIA

OAK TO NINTH DEVELOPMENT PROJECT

SHORELINE IMPROVEMENTS

SHORELINE LOCATION MAP

TABLE A: IMPACT/MITIGATION CONSTRUCTION SCHEDULE

PROJECT PHASE ***	SITE LOCATION	PROJECT IMPACTS				PROJECT MITIGATIONS		
		AMOUNT AND TYPE OF MATERIAL [BAYWARD OF (E)MHW]		DECREASE IN BAY SURFACE AREA AT MHW (NET) *	SURFACE AREA AFFECTED AT BAY BOTTOM [BAYWARD OF (E)MHW]		BAY SURFACE AREA AT MHW (NET)	SURFACE AREA AFFECTED AT BAY BOTTOM [BAYWARD OF (E)MHW]
		EXCAVATION	FILL		Fill in (E) Open Water	Revetment in (E) Open Water		
I (2014-2016)	Shoreline Park (Ninth Avenue Wharf)	100 cy (for outfall structure)	• 50 cy Revetment (concrete outfall structure)	None	None	0.01 ac (Temporary)	<ul style="list-style-type: none"> • Solid Fill: 0.03 ac Increase in Bay Surface Area • Shadow Fill: 1.48 ac Removal • Floating Fill: none 	None
	Shoreline Park (West)	None	None	None	None	None	<ul style="list-style-type: none"> • Solid Fill: 0.03 ac Increase in Bay Surface Area • Shadow Fill: 1.60 ac Removal • Floating Fill: none 	None
II (2016-2018)	Shoreline Park (West)	None	• 600 cy Revetment (Slope Dressing)	None	None	0.35 ac (Temporary)	<ul style="list-style-type: none"> • Solid Fill: none • Shadow Fill: none • Floating Fill: none 	None
	South Park (Clinton Basin) †	8,000 cy (shoreline protection)	• 3,000 cy Revetment • 19,700 cy Fill	<ul style="list-style-type: none"> • Solid Fill: -0.54 ac • Shadow Fill: -0.84 ac (Boardwalk) 	0.92 ac (Permanent)	0.35 ac (Permanent) 0.39 ac (Temporary)	<ul style="list-style-type: none"> • Solid Fill: [offset by Phase II Channel Park] • Shadow Fill: [offset by Phase I Removal] • Floating Fill: 0.59 ac Removal 	0.04 ac New Open Water
	Channel Park (Shoreline)	1,400 cy (to create marsh)	• 20 cy ACB Mat Revetment • 50 cy Fill • 1,350 cy Re-placed Fill	None	None	0.02 ac (Permanent) 0.29 ac (Temporary)	<ul style="list-style-type: none"> • Solid Fill: 0.64 ac Increase in Bay Surface Area • Shadow Fill: none • Floating Fill: none 	0.64 ac New Open Water
III (2018-2020)	South Park (West) ‡	700 cy (to create marsh)	• 50 cy ACB Mat Revetment • 150 cy Fill • 580 cy Re-placed Fill	None	None	0.05 ac (Permanent) 0.09 ac (Temporary)	<ul style="list-style-type: none"> • Solid Fill: 0.01 ac Increase in Bay Surface Area • Shadow Fill: none • Floating Fill: none 	0.01 ac New Open Water
IV (2020-2022)	Channel Park (Upland Area)	None	None	None	None	None	<ul style="list-style-type: none"> • Solid Fill: none • Shadow Fill: none • Floating Fill: none 	None
TOTALS		Excavate 10,200 cy	• 3,720 cy Revetment • 19,900 cy Fill • 1,930 cy Re-placed Fill	<ul style="list-style-type: none"> • Solid Fill: -0.54 ac • Shadow Fill: -0.84 ac (Boardwalk) • Floating Fill: -0.46 ac (For Future Docks) 	0.92 ac (Permanent)	0.42 ac (Permanent) 1.13 ac (Temporary)	<ul style="list-style-type: none"> • Solid Fill: 0.71 ac Increase in Bay Surface Area • Shadow Fill: 3.08 ac Removal • Floating Fill: 0.59 ac Removal 	0.69 ac New Open Water

* Negative values shown indicate decreases in Bay Surface Area at MHW

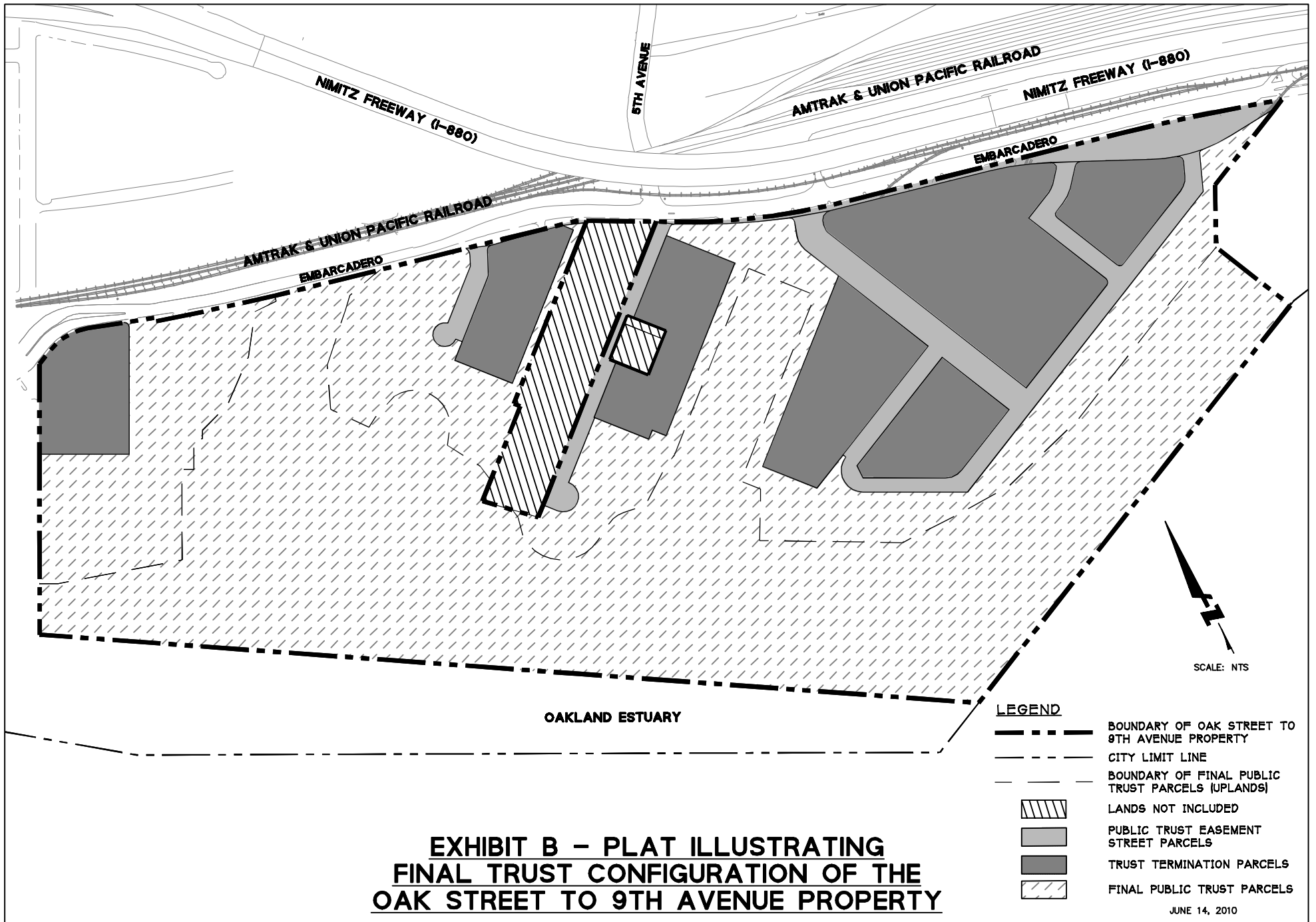
** Positive values shown indicate total mitigation credits at the end of each phase

*** Phase timeline shown is anticipated and may vary due to actual conditions

† Additional impact not listed in this table: Existing drainage ditch (0.003 ac) to be filled during this phase; see "Wetland Mitigation Plan"

‡ Additional impact not listed in this table: Existing seasonal pool (0.014 ac) to be filled during this phase; see "Wetland Mitigation Plan"

OAK STREET TO 9TH AVENUE PROPERTY



**EXHIBIT B - PLAT ILLUSTRATING
FINAL TRUST CONFIGURATION OF THE
OAK STREET TO 9TH AVENUE PROPERTY**

JUNE 14, 2010

ATTACHMENT 3

**Waste Discharge Requirements
and
Water Quality Certification
Oak to Ninth Project
City of Oakland, Alameda County**

**Post Construction Stormwater Treatment Measures
for the Project Site**

Attachment 3

Post-Construction Stormwater Management at the Project Site

Source Reduction Measures

The Project shall implement the source control measures described in the City of Oakland document *Source Control Measures to Limit Stormwater Pollution*, included as Appendix B to this Attachment to the Order, as appropriate for each phase of the Project.

To reduce the amount of impervious area at the site, the Project includes modified parking requirements. Parking for the Project shall be consistent with parking requirements for the City of Oakland Planned Waterfront Zoning District (PWD-4). To achieve adequate parking supply, the Project shall provide shared parking between different uses, since different users will have different times of peak demand. Implementing shared parking between different uses along with incorporating 3,448 of the total 3,902 parking spaces as off-street covered parking under buildings will significantly reduce the total paved area of the site, and thus reduce water quality impacts generated from impervious surfaces.

Post Construction Stormwater Treatment BMPS at the Oak to Ninth Project Site ***Bioretention Treatment Areas A, B, and C***

Phases II, III, and IV will be treated with bioretention areas C, B, and A respectively (see Figure 4 in Appendix A of this Attachment). Each bioretention area will be graded flat to promote an even distribution of ponding, and will include a network of 12-inch x 12-inch “bubble-ups”, providing one bubble-up for every 1,600 square-feet of bioretention area (i.e. about one bubble for each 2 acres of contributing impervious area)(See Sheets 2 of 7, 3 of 7, 4 of 7, 6 of 7 and 7 of 7 in Appendix A to this Attachment). Use of this distribution network will evenly distribute ponding and infiltration, consistent with the 2-acre treatment area limit recommended in the *Alameda County Clean Water Program (ACCWP) C.3 Stormwater Technical Guidance* handbook (http://www.cleanwaterprogram.org/uploads/01_ACCWP_Title-OCT19.pdf). Because of the relatively flat grades within the Project site, treatment flows will be delivered to the bubble ups in the bioretention areas with pumps, which will be located within treatment manholes (see Sheet 6 of 7 in Appendix A to this Attachment) that are sized to deliver the treatment volume to the bioretention cells. Bubble-ups will also dissipate the treatment flow velocity to reduce the risk of erosion or plant damage in the bioretention cell. Bioretention areas A, B and C have a design ponding depth of approximately 1-foot. Design calculations are summarized in Appendix D to this Attachment.

A 40 mil HDPE liner will be installed below bioretention areas A, B, and C, because local groundwater depth is within 10-feet of the existing grade. This liner will also separate the bioretention cells from any remaining soil and groundwater contamination in the subsurface of the site, which will prevent the migration of contaminated groundwater to the Bay via the subdrain systems of the bioretention cells. Depending on the adjacent land use, the borders of the bioretention areas will be designed as shown on Detail 3 of Sheet 6 of 7 in Appendix A to this Attachment. Bioretention areas will be constructed with the following two basic edge conditions:

- **Sidewalk/Trails:** A concrete downturned edge will be constructed to protect the sidewalk base materials from any potential damage from saturated bioretention soils. The 40 mil HDPE impermeable liner will also be placed along the downturned edge for further protection.

- **Landscape/Lawn/Park Areas:** These areas will include the 40 mil HDPE impermeable liner, which will extend from beneath the bioretention cell to within 6-inches of the finished ground.

As much as possible, bioretention areas at the site will include a 3H to 1V maximum slope around their perimeters to minimize safety risks associated with a sudden drop-off. Where bioretention areas are adjacent to sidewalks or other areas with high pedestrian activity, a 6-inch curb may also be installed next to the bioretention area to further improve safety. The Project will also consider the installation of bioretention planting that discourages public access on the perimeter of bioretention areas where public safety is a potential concern.

The bio-retention cells shall be designed in conformance with Provision C.3.c. (2)(vi) of the Municipal Regional Permit (MRP) (Regional Water Board Order R2-2009-0074 (adopted 10-14-09 and revised 11-28-11); NPDES Permit No. CAS612008), which states:

Biotreatment (or bioretention) systems shall be designed to have a surface area no smaller than what is required to accommodate a 5 inches/hour stormwater runoff surface loading rate, and infiltrate runoff at a minimum of 5 inches per hour during the life of the facility. The soil media for biotreatment (or bioretention) systems shall be designed to sustain healthy, vigorous plant growth and maximize stormwater runoff retention and pollutant removal. Permittees shall ensure that Regulated Projects use biotreatment soil media that meet the minimum specifications set forth in Attachment L (of this Order).

Since treatment flows will be delivered to bioretention areas by a pump, the volume of runoff will be limited to the treatment flow of 0.2 inches/hour. Bioretention areas will be isolated from flows greater than the treatment flow, since these flows will bypass the treatment manhole (see Sheet 6 of 7 in Appendix A to this Attachment) and discharge to the Bay via the Project's new outfalls (see Figure 4 in Appendix A to this Attachment). If bioretention areas receive treatment flows that result in greater than the 1-foot design ponding depth (or greater than 1.8 foot deep in Treatment Area D), overflow/outlet structures (see Sheet 6 of 7 in Appendix A to this Attachment) will discharge excess water directly to the new outfalls.

Planting plans for bioretention areas will be designed by a licensed landscape architect and will be consistent with the recommend plant list provided in Appendix B of the ACCWP C.3 Stormwater Technical Guidance handbook. Plants in the bioretention cells must be capable of withstanding periods of inundation and extended periods of drought.

Treatment Cell D - Extended Detention/Bioretention Treatment Area

The design for Treatment Area D will use a combination of interconnected detention basins and bioretention cells. The treatment volume will equalize between the basins via a leveling pipe and the treatment volume in the two basins will then percolate through the bioretention area located within the westernmost basin for final treatment and discharge to the Bay. See Sheets 5 of 7 and 7 of 7 in Appendix A to this Attachment for details and sections of the extended detention/bioretention area.

To enable treatment of the entire area of Phase I, the ponding depth in Treatment Cell D will need to be about 1.8-feet (See supporting calculations in Appendix D to this Attachment), which is deeper than the 1-foot depth that is typically recommended for bioretention areas.

As shown on Sheet 7 of 7 in Appendix A to this Attachment, the extended detention/bioretention area will be constructed of concrete, which will separate the bioretention cell from contact with

potential existing soil and groundwater contamination in the subsurface of the Project site.

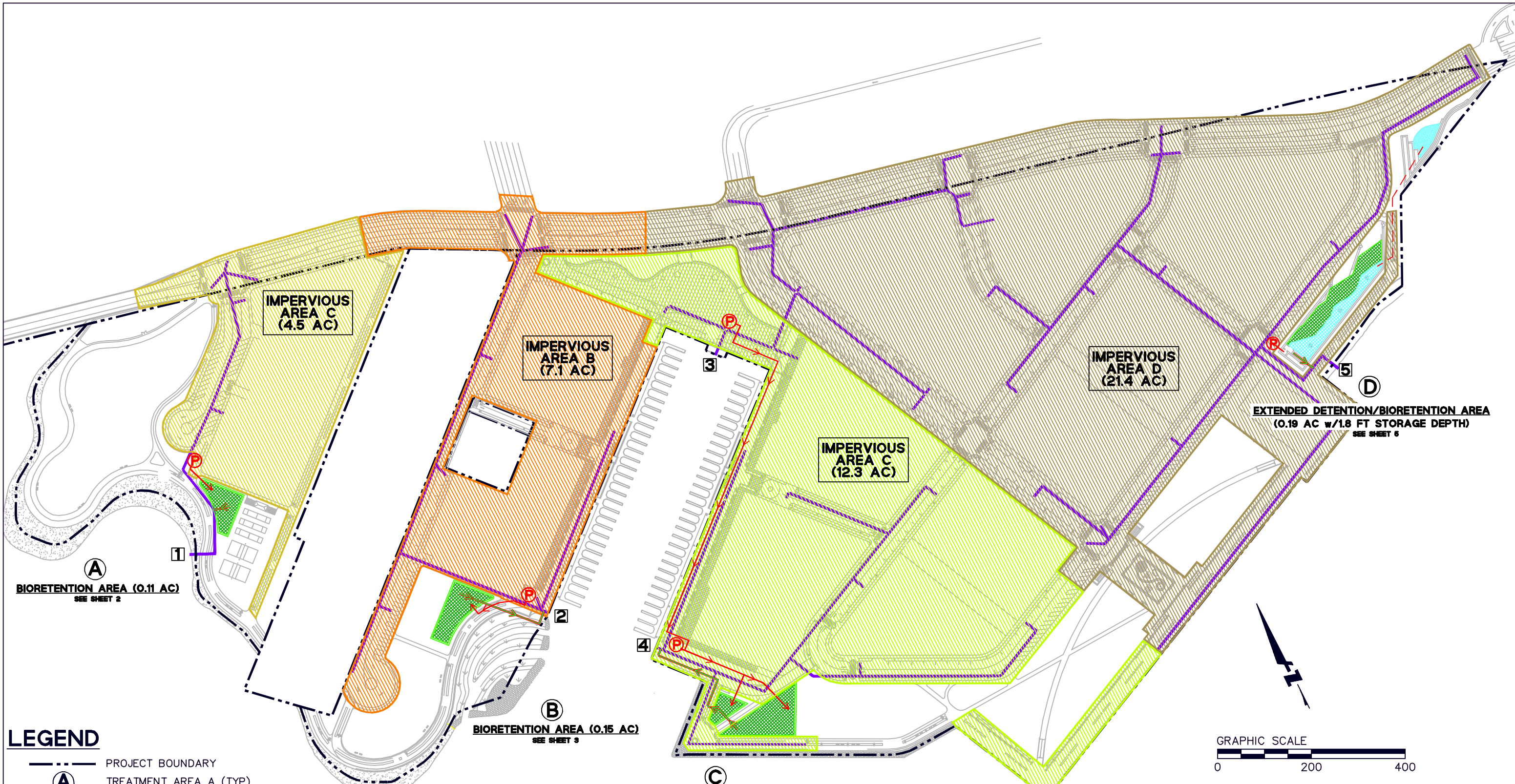
To minimize risk of sudden drop-off for users, the basin is designed with a series of steps on the southern limit of the basin to allow safe public access to the water feature. The northern side of the basin will have a graded slope no steeper than 3H to 1V, leading down to the bioretention areas as recommended in the ACCWP C.3 Stormwater Technical Guidance handbook.

Planting plans for bioretention areas will be designed by a licensed landscape architect. Landscape designs for bioretention areas will be consistent with the recommend plant list provided in Appendix B of the ACCWP C.3 Stormwater Technical Guidance handbook. As with locations A, B and C, the bioretention area of Treatment Area D will also consider installation of bioretention planting that discourages public access on the perimeter of bioretention areas where public safety is a potential concern. To compensate for the increased treatment water depth needed for the bioretention area, the planting scheme will use plants that are more suited to deeper inundation.

APPENDIX A

Treatment Control Details

DRAWING NAME: J:\Eng01\010287\0005\04\Exhibits\Utilities\10_1116_00 drainage area\04 Stormwater Treatment Areas Exhibits.dwg
 PLOT DATE: 11-25-10 PLOTTED BY: ksh



LEGEND

- PROJECT BOUNDARY
- TREATMENT AREA A (TYP)
- STORM DRAIN PIPE
- INTERCONNECTED LEVELING PIPE
- PUMP LINE TO TREATMENT AREA
- TREATMENT PUMP LOCATION
- TREATMENT AREA DISCHARGE TO STORM DRAIN
- BIORETENTION AREA
- WATER FEATURE
- PROPOSED OUTFALLS (5 TOTAL)

REFERENCE: ACCWP C3 STORMWATER TREATMENT GUIDELINES
 AUGUST 31, 2006 VERSION 1.0

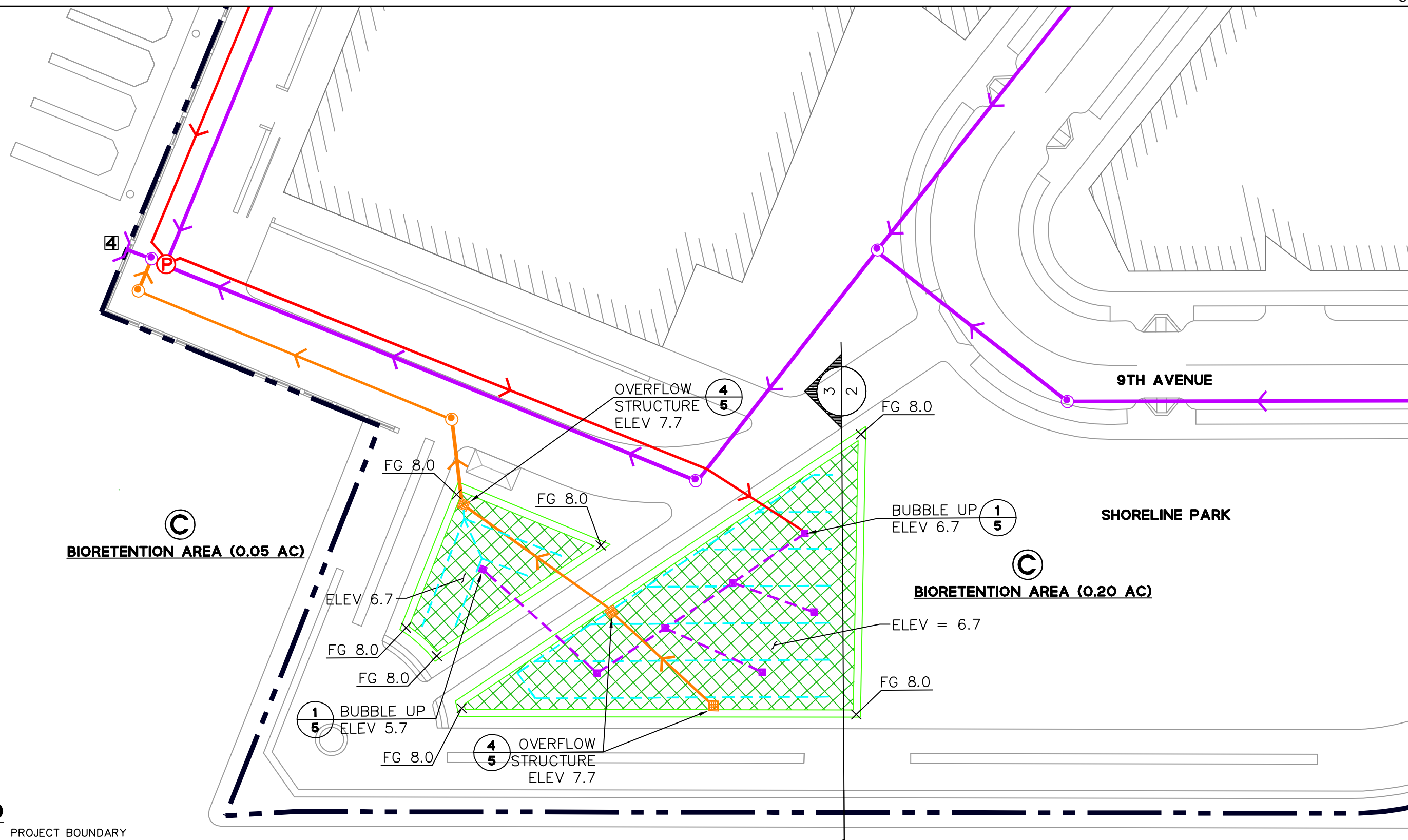
TOTAL IMPERVIOUS AREA = 45.3 ACRES
TOTAL TREATED AREA = 45.3 ACRES

FIGURE 4:
STORMWATER QUALITY CONTROL PLAN











BKF 255 SHORELINE DRIVE
 SUITE 200
 REDWOOD CITY, CA 94065
 650/482-6300
 650/482-6399 (FAX)
 ENGINEERS / SURVEYORS / PLANNERS

Revisions	
No.	Description

DRAWING NAME: J:\Eng\01\0261\DWG\TMA\A\hills\10_1116_SD_drainage_area\Stormwater_Treatment_Details.dwg
PLOT DATE: 11-23-10 PLOTTED BY: Kehr



LEGEND

-  PROJECT BOUNDARY
-  TREATMENT AREA A (TYP)
-  STORM DRAIN PIPE
-  PUMP LINE TO TREATMENT AREA
-  TREATMENT PUMP LOCATION
-  TREATMENT AREA DISCHARGE TO STORM DRAIN
-  BIORETENTION AREA BALANCING PIPE SYSTEM (FLAT)
-  PERFORATED UNDERDRAIN SYSTEM
-  BIORETENTION AREA
-  PROPOSED OUTFALL

OAKLAND ESTUARY

BIORETENTION AREA (0.05 AC)

BIORETENTION AREA (0.20 AC)

9TH AVENUE

SHORELINE PARK

OVERFLOW STRUCTURE
ELEV 7.7

BUBBLE UP
ELEV 6.7

BUBBLE UP
ELEV 5.7

OVERFLOW STRUCTURE
ELEV 7.7

ELEV 6.7

ELEV = 6.7

FG 8.0

FG 8.0

FG 8.0

FG 8.0

FG 8.0

FG 8.0

FG 8.0

4

4
5

1
5

1
5

4
5

3
2

C

C

APPENDIX B
City of Oakland Source Control
Measures to Limit Stormwater
Pollution



SOURCE CONTROL MEASURES TO LIMIT STORMWATER POLLUTION

On February 19, 2003, the Regional Water Quality Control Board, San Francisco Bay Region (SFRWQCB), issued a municipal stormwater permit under the National Pollutant Discharge Elimination System (NPDES) permit program to the Alameda Countywide Clean Water Program (ACCWP). The purpose of the permit is to reduce the discharge of pollutants in stormwater to the maximum extent practicable and to effectively prohibit non-stormwater discharges into municipal storm drain systems and watercourses. The City of Oakland, as a member of ACCWP, is a co-permittee under ACCWP's permit and is, therefore, subject to the permit requirements.

Provision C.3.k of the NPDES permit requires the City to impose source control measures to limit the generation, discharge, and runoff of pollutants in new development and redevelopment projects. Below are the City of Oakland Source Control Measures approved for use by the Chief of Building Services pursuant to Section 13.16.100 of the Oakland Municipal Code. These source control measures have been adapted from a model list developed by ACCWP for use by all co-permittees as specific conditions of project approval imposed by the City on applicable development and redevelopment projects. The City of Oakland Source Control Measures are effective immediately and are required in addition to standard stormwater-related best management practices (BMPs) required during construction and other post-construction stormwater pollution management requirements contained within the NPDES permit.

The source control measures below are divided into two categories: structural control measures and operational best management practices (BMPs). Listed with each group of source control measures is the City department, or departments, responsible for the permit review, construction inspection, and/or enforcement of each group of source control measures.¹

A. STRUCTURAL CONTROL MEASURES

This section describes source control measures that are physically incorporated into the design of a project. These source control measures apply to all building and other construction-related permits issued by the City for new facilities, wholly reconstructed facilities, and wholly reconstructed portions of existing facilities. The City of Oakland will verify a permit applicant's implementation of required source control measures during the review of construction plans, during construction inspections, and during inspections in response to complaints from the public.

1. Marking of storm drain inlets (CEDA Building Services Division)

- On-site storm drain inlets shall be clearly marked with the words "No Dumping! Flows to Bay," or equivalent, using methods approved by the City of Oakland.

¹ ABBREVIATIONS FOR CITY DEPARTMENTS:

2. Interior floor drains (CEDA Building Services Division)

- Interior floor drains shall be plumbed to the sanitary sewer system and shall not be connected to storm drains. The applicant shall contact the City of Oakland's Building Services Division for specific connection and discharge requirements.

3. Parking garages (CEDA Building Services Division)

- Interior level parking garage floor drains receiving non-stormwater discharge shall be connected to a water treatment device approved by the City of Oakland's Building Services Division (BSD) prior to discharging to the sanitary sewer system. The applicant shall contact BSD for specific connection and discharge requirements.

4. Pesticide/fertilizer application (CEDA Building Services Division; CEDA Planning and Zoning Division)

- Landscaping shall be designed to minimize irrigation and runoff, promote surface infiltration where appropriate, and minimize the use of fertilizers and pesticides that can contribute to stormwater pollution.
- Structures shall be designed to discourage the occurrence and entry of pests into buildings, thus minimizing the need for pesticides. For example, dumpster areas should be located away from occupied buildings, and building foundation vents shall be covered with screens.
- Landscaping shall comply with water-efficient landscape standards, as required.
- If a landscaping plan is required as part of a development project application, the plan shall meet the following conditions related to the reduction of pesticide use on the project site:
 - Where feasible, landscaping shall be designed and operated to treat stormwater runoff by incorporating elements that collect, detain, and infiltrate runoff. In areas that provide detention of water, plants that are tolerant of saturated soil conditions and prolonged exposure to water shall be specified.
 - Plant materials selected shall be appropriate to site specific characteristics such as soil type, topography, climate, amount and timing of sunlight, prevailing winds, rainfall, air movement, patterns of land use, ecological consistency, and plant interactions to ensure successful establishment.
 - Existing native trees, shrubs, and ground cover shall be retained and incorporated into the landscape plan to the maximum extent practicable.
 - Proper maintenance of landscaping, with minimal pesticide use, shall be the responsibility of the property owner.
 - Integrated pest management (IPM) principles and techniques shall be encouraged as part of the landscaping design. Examples of IPM principles and techniques include selecting plants that are well adapted to soil conditions at the site; selecting plants that are well adapted to sun and shade conditions at the site (consider future conditions when plants reach maturity and seasonal changes and time of day); providing irrigation appropriate to the water requirements of the selected plants; selecting pest- and disease-resistant plants; planting a diversity of species to prevent a potential pest infestation from affecting the entire landscaping plan; and using "insectary" plants in the landscaping to attract and keep beneficial insects.

5. Pool, spa, and fountain discharges (CEDA Building Services Division)

- Discharge drains from pools (including swimming pools, hot tubs, spas, and fountains but excluding public pools) shall not be connected directly to the storm drain or sanitary sewer system, unless the connection is specifically approved by the City of Oakland's Building Services Division.
- Subject to City requirements, when draining is necessary, a hose or other temporary system shall be directed into a sanitary sewer clean-out. The clean-out shall be installed in a readily accessible area. The applicant shall contact the City of Oakland's Building Services Division for specific connection and discharge requirements.
- Subject to City requirements, swimming pool, spa, and fountain water may be allowed to discharge to the storm drains if the water has been dechlorinated, the water is within ambient temperature, and no copper-based algae control projects have been added to the water.
- If commercial and public swimming pool discharges are discharged to land where the water would not flow to a storm drain or to a surface water, the discharge may be subject to the requirements of the State Water Resources Control Board's statewide general waste discharge requirements for discharges to land with a low threat to water quality.

6. Food service equipment cleaning (CEDA Building Services Division)

- Food service facilities (including restaurants and grocery stores) shall have a sink or other floor mat, container, and equipment cleaning area, which is connected to the sanitary sewer system. The cleaning area shall be large enough to clean the largest mat or piece of equipment to be cleaned. The cleaning area shall be indoors or in a roofed area outdoors; both areas must be plumbed to the sanitary sewer. Outdoor cleaning areas shall be designed to prevent stormwater run-on from entering the sanitary sewer and to prevent stormwater run-off from carrying pollutants to the storm drain. Signs shall be posted indicating that all food service equipment washing activities shall be conducted in this area. The applicant shall contact the City of Oakland's Building Services Division for specific connection and discharge requirements.

7. Refuse areas (CEDA Building Services Division; CEDA Planning and Zoning Division)

- New food-service facilities, recycling facilities, multi-family residential complexes or subdivisions, and similar facilities shall provide a roofed or enclosed area for dumpsters and recycling containers. The area shall be designed to prevent water run-on to the area and runoff from the area and to contain litter and trash, so that it is not dispersed by the wind or runoff during waste removal.
- Runoff from food service areas, trash enclosures, recycling areas, and/or food compactor enclosures or similar facilities shall not discharge to the storm drain system. Trash enclosure areas shall be designed to avoid run-on to the trash enclosure area. Any drains installed in or beneath dumpsters, compactors, and tallow bin areas serving food service facilities shall be connected to the sanitary sewer. The applicant shall contact the City of Oakland's Building Services Division for specific connection and discharge requirements.

- 8. Outdoor process activities/equipment** (CEDA Building Services Division; OFD Office of Emergency Services; applies to machine shops and auto repair shops, and industries that have pretreatment facilities)
- Process activities shall be performed either indoors or in roofed outdoor areas. If performed outdoors, the area shall be designed to prevent run-on to and runoff from the area with process activities.
 - Process equipment areas shall drain to the sanitary sewer system. The applicant shall contact the City of Oakland's Building Services Division for specific connection and discharge requirements.
- 9. Outdoor equipment/materials storage** (CEDA Building Services Division; CEDA Planning and Zoning Division; OFD Office of Emergency Services)
- All outdoor equipment and materials storage areas shall be covered and bermed, or shall be designed with BMPs to limit the potential for runoff to contact pollutants.
 - Storage areas containing non-hazardous liquids shall be covered by a roof and drain to the sanitary sewer system, and be contained by berms, dikes, liners, vaults or similar spill containment devices. The applicant shall contact the City of Oakland's Building Services Division for specific connection and discharge requirements.
 - All on-site hazardous materials and wastes, as defined and/or regulated by the California Public Health Code and the Oakland Fire Department, acting as the local Certified Unified Program Agency (CUPA), must be used and managed in compliance with the applicable CUPA program regulations and the facility hazardous materials management plan approved by the CUPA authority.
- 10. Vehicle/equipment and commercial/industrial cleaning** (CEDA Building Services Division; CEDA Planning and Zoning Division; OFD Office of Emergency Services)
- Wastewater from vehicle and equipment washing operations shall not be discharged to the storm drain system, with the exception of water containing no soap or other cleaning agent that is used in a car dealership for minimal rinsing of exterior vehicles surfaces for appearance purposes.
 - Commercial/industrial facilities having vehicle/equipment cleaning needs shall provide a roofed, bermed area for washing activities. Vehicle/equipment washing areas shall be designed to prevent run-on to or runoff from the area, and plumbed to drain to the sanitary sewer. A sign shall be posted indicating the location and allowed uses in the designated wash area. The applicant shall contact the City of Oakland's Building Services Division for specific connection and discharge requirements.
 - Commercial car wash facilities shall be designed and operated such that no runoff from the facility is discharged to the storm drain system. Wastewater from the facility shall discharge to the sanitary sewer, or a wastewater reclamation system shall be installed and the wastewater reused with no discharges to the storm drain. The applicant shall contact the City of Oakland's Building Services Division for specific connection and discharge requirements.

11. Vehicle/equipment repair and maintenance (CEDA Building Services Division; CEDA Planning and Zoning Division; OFD Office of Emergency Services)

- Vehicle/equipment repair and maintenance shall be performed in a designated area indoors, or if such services must be performed outdoors, in an area designed to prevent the run-on and runoff of stormwater.
- Secondary containment shall be provided for exterior work areas where motor oil, brake fluid, gasoline, diesel fuel, radiator fluid, acid-containing batteries or other hazardous materials or hazardous wastes are used or stored. Drains shall not be installed within the secondary containment areas.
- Vehicle service facilities shall not contain floor drains unless the floor drains are connected to wastewater pretreatment systems prior to discharge to the sanitary sewer, for which an industrial waste discharge permit has been obtained. The applicant shall contact the City of Oakland's Building Services Division for specific connection and discharge requirements.
- Tanks, containers, or sinks used for parts cleaning or rinsing shall not be connected to the storm drain system. Tanks, containers, or sinks used for such purposes may only be connected to the sanitary sewer system if allowed by an industrial waste discharge permit. The applicant shall contact the City of Oakland's Building Services Division for specific connection and discharge requirements.

12. Fuel dispensing areas (CEDA Building Services Division; CEDA Planning and Zoning Division; OFD Office of Emergency Services)

- Fueling areas (defined as the area extending a minimum of 6.5 feet from the corner of each fuel dispenser or the length at which the hose and nozzle assembly may be operated plus a minimum of one foot, whichever is greater) shall have impermeable surfaces (i.e., Portland cement concrete or equivalent smooth impervious surface) that are graded at the minimum slope necessary to prevent ponding and separated from the rest of the site by a grade break that prevents run-on of stormwater to the maximum extent practicable.
- Fueling areas shall be covered by a canopy that extends a minimum of ten feet in each direction from each pump or by a roof the minimum dimensions of which must be equal to or greater than the area within the grade break or fuel dispensing area. The canopy or roof shall not drain onto the fueling area.

13. Loading docks (CEDA Building Services Division)

- Loading docks shall be covered or graded to minimize run-on to and runoff from the loading area. Roof downspouts shall be positioned to direct stormwater away from the loading area. Stormwater runoff from loading dock areas shall be drained to the sanitary sewer, diverted and collected for ultimate discharge to the sanitary sewer, or connected to a post-construction stormwater treatment measure prior to discharge to the storm drain system. The applicant shall contact the City of Oakland's Building Services Division for specific connection and discharge requirements.
- Door skirts between the trailers and the building shall be installed to prevent exposure of loading activities to rain, unless one of the following conditions apply: the loading dock is covered, or the

applicant demonstrates that rainfall will not result in an untreated discharge to the storm drain system.

14. Fire sprinkler test water (OFD Fire Prevention Bureau)

- Fire sprinkler test water shall be drained to the sanitary sewer system (with approval from the City of Oakland's Building Services Division, or BSD) or drain to landscaped areas where feasible. In the event that BSD does not approve the connection and drainage to landscaped areas is infeasible, the applicant may propose an alternative method of providing for drainage of fire sprinkler test water, such as by filtering and dechlorinating the water prior to discharge to a storm drain, subject to approval by SFRWQCB staff.

15. Boiler drain lines (CEDA Building Services Division)

- Boiler drain lines shall be directly or indirectly connected to the sanitary sewer system and may not discharge to the storm drain system. The applicant shall contact the City of Oakland's Building Services Division for specific connection and discharge requirements.

16. Air conditioning units (CEDA Building Services Division)

- For small air conditioning units, air conditioning condensate should be directed to landscaped areas as a minimum BMP. For large air conditioning units, in new developments or significant redevelopments, the preferred alternatives are for condensate lines to be directed to landscaped areas, or alternatively connected to the sanitary sewer system after obtaining permission from the City of Oakland's Building Services Division. Air conditioning condensate lines may discharge to the storm drain system provided they are not a source of pollutants. As with smaller units, any anti-algal or descaling agents must be properly disposed of. Any air conditioning condensate that discharges to land without flowing to a storm drain may be subject to the requirements of the State Water Resources Control Board's statewide general waste discharge requirements for discharges to land with a low threat to water quality.

17. Roof drains (CEDA Building Services Division)

- Roof drains shall discharge and drain away from the building foundation to an unpaved area wherever practicable.

18. Roof-top equipment (CEDA Building Services Division)

- Roof-top equipment other than that producing air conditioning condensate shall drain to the sanitary sewer (if its drainage does not come in contact with stormwater) or shall be covered and have no discharge to the storm drain. The applicant shall contact the City of Oakland's Building Services Division for specific connection and discharge requirements.

19. Washing and steam-cleaning (CEDA Building Services Division)

- Most washing and/or steam-cleaning must be done at an appropriately equipped facility that drains to the sanitary sewer. Any outdoor washing or pressure washing must be managed in such a way that there is no discharge of soaps or other pollutants to the storm drain. The applicant shall contact the City of Oakland's Building Services Division for specific connection and discharge requirements.

B. OPERATIONAL BMPs

This section describes operational best management practices (BMPs) that rely on a property owner to implement following the construction of a project. These BMPs apply to all building and other construction-related permits issued by the City. Responsibility for implementation of these BMPs clearly rests with the property owners. The City of Oakland will verify a property owner/operator's implementation of required operational BMPs during industrial and commercial business inspections and during inspections in response to complaints from the public.

1. Paved sidewalks and parking lots (CEDA Building Services Division; PWA Environmental Services Division)

- Sidewalks and parking lots shall be swept regularly to minimize the accumulation of litter and debris. Debris resulting from pressure washing shall be trapped and collected to prevent entry into the storm drain system. Washwater containing any soap, cleaning agent, or degreaser shall not be discharged to the storm drain and shall be collected and either discharged to the sanitary sewer or treated prior to being lawfully disposed of. The applicant shall contact the City of Oakland's Building Services Division for specific connection and discharge requirements.

2. Private streets, utilities, and common areas (CEDA Building Services Division; CEDA Planning Zoning Division)

- The owner of private streets and storm drains shall prepare and implement a plan for street sweeping of paved private roads and cleaning of all storm drain inlets.
- For residential developments where other maintenance mechanisms are not applicable or otherwise in place, a property owners' association, architectural committee, maintenance assessment district, special assessment district, or similar organization or arrangement shall be created and be responsible for maintaining all private streets and private utilities and other privately owned common areas and facilities on the site including the landscaping. These maintenance responsibilities shall include implementing and maintaining stormwater BMPs associated with improvements and landscaping and may include the maintenance responsibilities described in the maintenance plan that would be included as an attachment to the stormwater treatment measure maintenance agreement for the subject property. CC&R's creating a property owners' association may be reviewed and approved by the City of Oakland Attorney's Office prior to the recordation of a final map and shall be recorded prior to the sale of the first residential unit. The CC&R's or special assessment district shall describe how the stormwater BMPs associated with privately owned improvements and landscaping shall be maintained by the association or the special assessment district.

3. Vehicle/equipment repair and maintenance (CEDA Building Services Division; OPD Office of Emergency Services; PWA Environmental Services Division)

- No person shall dispose of, nor permit the disposal, directly or indirectly, of vehicle fluids, hazardous materials, or rinsewater from parts cleaning operations into storm drains.
- No vehicle fluid removal shall be performed outside a building, nor on asphalt or ground surfaces, whether inside or outside a building, except in such a manner as to ensure that any spilled fluid will be in an area of secondary containment. Leaking vehicle fluids shall be contained or drained from the vehicle immediately.
- No person shall leave unattended drip parts or other open containers containing vehicle fluid, unless such containers are in use or in an area that cannot discharge to the storm drain, such as an area with secondary containment.

4. Fueling areas (CEDA Building Services Division; OPD Office of Emergency Services; PWA Environmental Services Division)

- The property owner shall dry sweep the fueling area and spot clean leaks and drips routinely. Fueling areas shall not be washed down with water unless the wash water is collected and disposed of properly (i.e., not in the storm drain).

5. Loading docks (CEDA Building Services Division)

- The property owner shall ensure that BMPs are implemented to prevent potential stormwater pollution. These BMPs shall include, but are not limited to, a regular program of sweeping, litter control, and spill clean-up.

6. On-site storm drains (CEDA Building Services Division)

- All on-site storm drains must be inspected and, if necessary, cleaned at least once a year immediately prior to the rainy season. Additional cleaning may be required by the City of Oakland.



Natural, 4" Disc
Material: Aluminum
Symbol: Fish



Natural, 4" Disc
Material: Brass
Symbol: Crab



Natural, 4" Disc
Material: Stainless Steel
Symbol: Fish



1 Color, 4" Disc
Material: Stainless Steel
Symbol: Fish
Option: Rivet Fastener



1 Color, 4" Disc
Material: Stainless Steel
Symbol: Catch Basin



2 Colors, 4" Disc
Material: Stainless Steel
Symbol: Lobster



1 Color, 4" Disc
Material: Aluminum
Symbol: Lobster



1 Color, 4" Disc
Material: Brass
Symbol: Crab



1 Color, 4" Disc
Material: Stainless Steel
Symbol: Fish
Option: Serialization



1 Color, 4" Disc
Material: Stainless Steel
Symbol: Trout

CUSTOM MARKERS



RECTANGULAR MARKER



1 Color, 3"x10" Rectangle
Material: Aluminum (Also Avail. in Stainless Steel)
Symbol: Trout

NEW!



1 Color, 2 1/8" Disc
Material: Avail in Stainless Steel, Anodized Aluminum & Brass
Standard & Custom Symbols, Colors & Legends Available

APPENDIX D

Treatment Measure Sizing Calculations

OUTFALL 1 TREATMENT AREA CALCULATIONS

	TREATMENT MEASURE:	Bio-retention Area	
	SIZING METHODOLOGY:	Flow and Volume Design Basis	
A	Impervious Area:	196,020	Square Feet (SF)
C	Composite C Factor:	0.9	
i	2x 85th Percentile Intensity	0.2	in/hr

STEPS

1 Use 4% rule to determine preliminary treatment area size

Area:	196,020 SF
4% of Area:	7,841 SF

2 Determine the duration of the Treatment Event Rainfall

Mean Annual Precipitation:	21 inches
48 hr Unit Basin Storage Volume:	0.60 inches
Adjusted Unit Basin Storage Vol.:	0.69 inches
Readjusted for 100% capture	0.77 inches
Duration of Rainfall	3.83 hours

3 Total Volume for 48 hr. Rainfall Event

Composite C x A	176,418 SF
-----------------	------------

4 Required Treatment Volume

Composite C x A	176,418 in/hr
Adj. Unit Basin Storage Volume	0.69 inches
Treatment Volume	10,144 cubic feet (CF)

5 Volume of Runoff Filtered through Soils

Soil Media Infiltration Rate	0.42 ft/hr
Estimated Reduced Treatment Area	3,999 SF
	0.10 Ac
Volume of Treated Runoff in Soils	6,428 CF

6 Determine Depth of Surface Storage

Remaining Treatment Volume	3,716 ft/hr
Storage Depth	0.93 feet

OUTFALL 2 TREATMENT AREA CALCULATIONS

	TREATMENT MEASURE:	Bio-retention Area	
	SIZING METHODOLOGY:	Flow and Volume Design Basis	
A	Impervious Area:	309,276	Square Feet (SF)
C	Composite C Factor:	0.9	
i	2x 85th Percentile Intensity	0.2	in/hr

STEPS

1 Use 4% rule to determine preliminary treatment area size

Area:	309,276 SF
4% of Area:	12,371 SF

2 Determine the duration of the Treatment Event Rainfall

Mean Annual Precipitation:	21 inches
48 hr Unit Basin Storage Volume:	0.60 inches
Adjusted Unit Basin Storage Vol.:	0.69 inches
Readjusted for 100% capture	0.77 inches
Duration of Rainfall	3.83 hours

3 Total Volume for 48 hr. Rainfall Event

Composite C x A	278,348 SF
-----------------	------------

4 Required Treatment Volume

Composite C x A	278,348 in/hr
Adj. Unit Basin Storage Volume	0.69 inches
Treatment Volume	16,005 cubic feet (CF)

5 Volume of Runoff Filtered through Soils

Soil Media Infiltration Rate	0.42 ft/hr
Estimated Reduced Treatment Area	6,309 SF
	0.14 Ac
Volume of Treated Runoff in Soils	10,142 CF

6 Determine Depth of Surface Storage

Remaining Treatment Volume	5,863 ft/hr
Storage Depth	0.93 feet

OUTFALL 4 TREATMENT AREA CALCULATIONS

TREATMENT MEASURE: Bio-retention Area
SIZING METHODOLOGY: Flow and Volume Design Basis

A	Impervious Area:	537,197	Square Feet (SF)
C	Composite C Factor:	0.9	
i	2x 85th Percentile Intensity	0.2	in/hr

STEPS

1 Use 4% rule to determine preliminary treatment area size

Area:	537,197 SF
4% of Area:	21,488 SF

2 Determine the duration of the Treatment Event Rainfall

Mean Annual Precipitation:	21 inches
48 hr Unit Basin Storage Volume:	0.60 inches
Adjusted Unit Basin Storage Vol.:	0.69 inches
Readjusted for 100% capture	0.77 inches
Duration of Rainfall	3.83 hours

3 Total Volume for 48 hr. Rainfall Event

Composite C x A	483,477 SF
-----------------	------------

4 Required Treatment Volume

Composite C x A	483,477 in/hr
Adj. Unit Basin Storage Volume	0.69 inches
Treatment Volume	27,800 cubic feet (CF)

5 Volume of Runoff Filtered through Soils

Soil Media Infiltration Rate	0.42 ft/hr
Estimated Reduced Treatment Area	10,959 SF
	0.25 Ac
Volume of Treated Runoff in Soils	17,617 CF

6 Determine Depth of Surface Storage

Remaining Treatment Volume	10,183 ft/hr
Storage Depth	0.93 feet

OUTFALL 5 TREATMENT AREA CALCULATIONS

	TREATMENT MEASURE:	Bio-retention Area	
	SIZING METHODOLOGY:	Flow and Volume Design Basis	
A	Impervious Area:	930,923	Square Feet (SF)
C	Composite C Factor:	0.804	
i	2x 85th Percentile Intensity	0.2	in/hr

STEPS

1 Use 4% rule to determine preliminary treatment area size

Area:	930,923 SF
4% of Area:	37,237 SF

2 Determine the duration of the Treatment Event Rainfall

Mean Annual Precipitation:	21 inches
48 hr Unit Basin Storage Volume:	0.60 inches
Adjusted Unit Basin Storage Vol.:	0.69 inches
Readjusted for 100% capture	0.86 inches
Duration of Rainfall	4.28 hours

3 Total Volume for 48 hr. Rainfall Event

Composite C x A	748,462 SF
-----------------	------------

4 Required Treatment Volume

Composite C x A	748,462 in/hr
Adj. Unit Basin Storage Volume	0.69 inches
Treatment Volume	42,970 cubic feet (CF)

5 Volume of Runoff Filtered through Soils

Soil Media Infiltration Rate	0.42 ft/hr
Estimated Reduced Treatment Area	8,274 SF
	0.19 Ac
Volume of Treated Runoff in Soils	14,889 CF

6 Determine Depth of Surface Storage

Remaining Treatment Volume	28,081 CF
Surface Storage Area	16,081 SF
Storage Depth	1.75 feet

ATTACHMENT 4

**Waste Discharge Requirements
and
Water Quality Certification
Oak to Ninth Project
City of Oakland, Alameda County**

**Groundwater and Soil Contamination Levels at the
Project Site
and
Protocols for Discharging Contaminated Groundwater
During Project Construction**

Attachment 4. Contamination at the Project Site and Construction Dewatering.

Disposal and/or Treatment of Extracted Groundwater and Decontamination Wash Water.

Extracted groundwater and decontamination wash water will either be discharged to the East Bay Municipal Utility District (EBMUD) sanitary sewer system or will be treated onsite and discharged to the Bay under a National Pollutant Discharge Elimination System (NPDES) discharge permit. The Discharger prefers to discharge water to EBMUD, but if the quantity of extracted groundwater is too large to make discharge to EBMUD facilities practical, onsite treatment and discharge to the Bay may be necessary. The Discharger shall inform the Regional Water Board of the method selected for each phase of the Project no later than 60 days prior to the start of Project construction for that phase.

Discharge of Extracted Groundwater to EBMUD

If extracted groundwater and decontamination wash water will be disposed of by trucking to the East Bay Municipal Utility District (EBMUD) treatment plant or discharged directly to the EBMUD sanitary sewer, the Contractor shall apply for an EBMUD permit for trucked waste and/or direct discharge to the sanitary sewer. Final EBMUD permit conditions will be specified when the permit is issued. EBMUD disposal options may be further evaluated after approval of EBMUD permits that specify discharge limits.

The planned protocol for managing extracted groundwater generated during soil remediation or excavation activities at the Site is summarized below.

- If untreated groundwater meets the discharge standards in the EBMUD permit for trucked waste or direct discharge to sanitary sewer, extracted groundwater will be trucked to the EBMUD treatment plant for disposal or directly discharged to the EBMUD sanitary sewer without treatment.
- If chemical concentrations in the untreated groundwater exceed the discharge standards in the EBMUD permit for trucked waste or direct discharge to sanitary sewer, the Contractor will dispose of the extracted groundwater at a DTSC-permitted off-site disposal facility unless the volume of extracted groundwater is sufficient to make off-site disposal of extracted groundwater cost prohibitive.
- If off-site disposal of extracted groundwater is deemed to be cost prohibitive, the Contractor will treat extracted groundwater using an on-site treatment system to meet discharge standards in the EBMUD permit for trucked waste or direct discharge to sanitary sewer. Treated groundwater will then be trucked to the EBMUD treatment plant for disposal or directly discharged to the EBMUD sanitary sewer.

Recovered separate phase product, if present, will be disposed of at an off-site DTSC-permitted facility. Excavation dewatering water, decontamination wash water, and recovered separate phase product will be transported and/or disposed in accordance with procedures to be identified in the Traffic Control and Waste Transportation Plan as required by the *Final Response Plan for the Oak-to-Ninth development* (EKI, 2010).

If a temporary on-site groundwater treatment system for extracted groundwater is required prior to trucking to the EBMUD treatment plant for disposal or discharging directly to the EBMUD sanitary sewer, the final design of the treatment system will be provided by the Contractor as part of the EBMUD permit application, and it may include equalization and settling tank(s), multi-media filters to remove sediments, oil-water separator to remove potential separate phase product,

and granular activated carbon to remove organic compounds. The treated effluent will be trucked to the EBMUD treatment plant for disposal or directly discharged to the EBMUD sanitary sewer.

Based on the Site data summarized in the *Final Response Plan for the Oak-to-Ninth development* (EKI, 2010) (See Table 1 in this Attachment), the combined influent stream from dewatering and extracting groundwater from the excavations during soil remediation activities is anticipated to qualify as non-hazardous waste. Under California Health and Safety Code, Division 20, Chapter 6.8, Section 25358.9(a), if the remedial action is implemented in accordance with a Remedial Action Plan pursuant to Section 25356.1, and the response action complies with the laws and regulations, the DTSC may exclude the response action conducted entirely from on-site hazardous waste facility permit requirements of Section 25201.

The temporary on-site groundwater treatment and extraction system will be operated throughout the excavation and backfill phases of the project but will not be a permanent facility. After completion of soil excavation for Project construction, the Contractor will remove the treatment system.

Discharge to Surface Water under the VOC and Fuel General Permit.

The Regional Water Board adopted Resolution No. 88-160 on October 19, 1988. The Resolution urges dischargers of extracted groundwater from site cleanup projects to reuse their treated groundwater. When reuse is not technically and/or economically feasible, dischargers are to discharge the groundwater to a publicly owned treatment works (POTW). If neither reuse nor discharge to a POTW is technically or economically feasible, and if beneficial uses of the receiving water will not be adversely affected, the Regional Water Board may authorize the discharge of treated groundwater in accordance with the requirements of Regional Water Board Order No. R2-2012-0012 (NPDES No. CAG912002), *General Waste Discharge Requirements For: Discharge or Reuse of Extracted and Treated Groundwater Resulting from the Cleanup of Groundwater Polluted by Volatile Organic Compounds (VOCs), Fuel Leaks and Other Related Wastes* (VOC and Fuel General Permit).

If treatment and disposal to EBMUD facilities is not practical, the Discharger may treat extracted groundwater and discharge it to the Oakland Inner Harbor under the VOC and Fuel General Permit. If contaminant levels are consistent with the use of the VOC and Fuel General Permit, the Discharger will file a Notice of Intent (NOI) Form, as described in the VOC and Fuel General Permit, and a filing fee equivalent to the first year's annual fee, and receive an Authorization to Discharge letter form the Regional Water Board's Executive Officer prior to discharging treated water to the Oakland Inner Harbor. The Discharger is responsible for complying with the discharge limitations, including the treatment levels for constituents of concern, set forth in the VOC and Fuel General Permit.

TABLE 1
SUMMARY OF GROUNDWATER DATA
Oakland Harbor Partners, LLC, Oakland, California

Chemical (a)	Groundwater						Screening Level Based on Surface Water Protection (ug/L) (c)
	Number of Samples Analyzed	Number of Detections	Frequency of Detection	Minimum Detection (ug/L)	Maximum Detection (ug/L) (b)		
Metals and Cyanide							
Antimony	158	37	23%	1.02	64.7	500	ESL
Arsenic	162	127	78%	1.01	63	36	ESL
Barium	161	161	100%	11	4,500	50,000	ESL
Beryllium	158	11	7%	2	3.6	50,000	ESL
Cadmium	179	4	2%	2	5.1	9.3	ESL
Chromium	177	85	48%	1.23	84	50,000	ESL
Chromium, Hexavalent	73	17	23%	0.204	160	50	ESL
Cobalt	158	57	36%	1.03	58	50,000	ESL
Copper	209	113	54%	1.27	1,800	3.1	ESL
Cyanide	10	1	10%	20	20	1	ESL
Dibutyltin	57	35	61%	0.33	0.62	0.0074	EPA
Lead	241	56	23%	1.16	2,300	6	ESL
Mercury	183	31	17%	0.2	11	0.025	ESL
Molybdenum	158	73	46%	1.04	80.7	50,000	ESL
Nickel	175	95	54%	1.46	83	8.2	ESL
Selenium	162	128	79%	1.62	70.3	71	ESL
Silver	162	6	4%	1.03	1.73	0.19	ESL
Thallium	158	0	0%	0	0	4	ESL
Tin	252	0	0%	0	0	--	--
Tributyltin	57	0	0%	0	0	0.0074	EPA
Vanadium	158	84	53%	1.08	62	50,000	ESL
Zinc	196	124	63%	4.21	1,000	81	ESL
VOCs							
Acetone	252	26	10%	11	18,000	50,000	ESL
Benzene	548	112	20%	0.5	8,600	350	ESL
Bromomethane	301	1	0%	417	417	3,200	ESL
1,3-Butadiene	0	0	--	--	--	--	--
2-Butanone	251	36	14%	5.2	14,000	50,000	ESL
tert-Butyl Alcohol	18	2	11%	20	21	50,000	
n-Butylbenzene	125	1	1%	2.58	2.58	--	--
sec-Butylbenzene	125	1	1%	1.4	1.4	--	--
Carbon Disulfide	250	13	5%	1	170	--	--
Chlorobenzene	367	33	9%	0.51	2,200	64.5	ESL
Chloroethane	358	22	6%	100	6,300	160	ESL
Chloroform	308	4	1%	0.73	240	3,200	ESL
Chloromethane	301	0	0%	--	--	3,200	ESL
Cyclohexane	--	--	--	--	--	--	--
1,2-Dibromo-3-Chloropropane	102	1	1%	1.8	1.8	100	ESL
1,2-Dichlorobenzene	162	1	1%	2.5	2.5	64.5	ESL
1,3-Dichlorobenzene	162	0	0%	--	--	65	ESL
1,4-Dichlorobenzene	163	7	4%	4.45	22	64.5	ESL
Dichlorodifluoromethane	160	0	0%	--	--	--	--
1,1-Dichloroethane	366	40	11%	0.5	20,000	50,000	ESL
1,2-Dichloroethane	370	12	3%	2.9	740	2000	ESL
1,1-Dichloroethene	366	16	4%	0.6	1,370	15,000	ESL

TABLE 1
SUMMARY OF GROUNDWATER DATA
Oakland Harbor Partners, LLC, Oakland, California

Chemical (a)	Groundwater						Screening Level Based on Surface Water Protection (ug/L) (c)
	Number of Samples Analyzed	Number of Detections	Frequency of Detection	Minimum Detection (ug/L)	Maximum Detection (ug/L) (b)		
VOCs							
cis-1,2-Dichloroethene	344	45	13%	0.57	260,000	22,400	ESL
trans-1,2-Dichloroethene	351	23	7%	1.5	2,700	2,600	ESL
1,2-Dichloroethene, Total	21	1	5%	1.6	1.6	--	--
1,2-Dichloropropane	301	0	0%	--	--	100	ESL
trans-1,3-Dichloropropene	301	0	0%	--	--	--	--
1,1-Difluoroethane	--	--	--	--	--	--	--
Diisopropyl Ether	18	1	6%	16	16	--	--
1,4-Dioxane	79	1	1%	238	238	50,000	ESL
Ethanol	--	--	--	--	--	--	--
Ethene	77	1	1%	590	590	--	--
Ethylbenzene	548	85	16%	0.53	1,300	43	ESL
4-Ethyltoluene	--	--	--	--	--	--	--
Heptane	--	--	--	--	--	--	--
Hexane	--	--	--	--	--	--	--
2-Hexanone	193	0	0%	--	--	--	--
Iso-octane	--	--	--	--	--	--	--
Isopropanol	--	--	--	--	--	--	--
Isopropylbenzene	137	1	1%	3.4	3.4	--	--
4-Isopropyltoluene	125	1	1%	3.54	3.54	--	--
Methane	88	77	88%	3.18	7,941	--	--
4-Methyl-2-Pentanone	251	2	1%	17	5,600	13,000	ESL
Methyl-tert-Butyl Ether	150	7	5%	0.5	30	--	--
Methylene Chloride	301	0	0%	--	--	3,200	ESL
Naphthalene	137	12	9%	2.68	2,410	62	ESL
n-Propylbenzene	125	3	2%	6.31	118	--	--
Styrene	278	0	0%	--	--	110	ESL
Tetrachloroethene	301	1	0%	0.62	0.62	225	ESL
Tetrahydrofuran	0	0	--	--	--	--	--
Toluene	547	92	17%	0.3	17,000	400	ESL
1,1,1-Trichloroethane	364	25	7%	12	53,000	3,120	ESL
Trichloroethene	366	28	8%	0.73	160,000	2,190	ESL
Trichlorofluoromethane	299	0	0%	--	--	--	--
Trichlorotrifluoroethane	279	0	0%	--	--	--	--
1,2,4-Trimethylbenzene	125	1	1%	0.78	0.78	--	--
1,3,5-Trimethylbenzene	125	2	2%	0.55	9.7	--	--
Vinyl Chloride	366	29	8%	0.95	16,000	34,000	ESL
Xylenes, Total	544	97	18%	0.7	5,660	100	ESL
SVOCs (Including PAHs and TICs)							
Acenaphthene	167	15	9%	0.19	142	40	ESL
Acenaphthylene	167	4	2%	0.15	2.6	30	ESL
Anthracene	167	10	6%	0.12	21.1	22	ESL
Benzo(a)Anthracene	166	3	2%	0.11	0.69	5	ESL
Benzo(a)Pyrene	167	2	1%	0.25	0.35	1.9	ESL

TABLE 1
SUMMARY OF GROUNDWATER DATA
Oakland Harbor Partners, LLC, Oakland, California

Chemical (a)	Groundwater						Screening Level Based on Surface Water Protection (ug/L) (c)
	Number of Samples Analyzed	Number of Detections	Frequency of Detection	Minimum Detection (ug/L)	Maximum Detection (ug/L) (b)		
SVOCs (Including PAHs and TICs)							
Benzo(b)Fluoranthene	119	2	2%	0.27	0.62	7	ESL
Benzo(b,k)Fluoranthene	48	0	0%	0	--	--	--
Benzo(g,h,i)Perylene	165	1	1%	0.16	0.16	0.13	ESL
Benzo(k)Fluoranthene	119	1	1%	0.18	0.18	0.4	ESL
Benzoic Acid	50	1	2%	280	280	--	--
Benzyl Alcohol	130	1	1%	11	11	--	--
Benzyl Butyl Phthalate	129	0	0%	0	--	--	--
Bis(2-Ethylhexyl)Phthalate	130	1	1%	11	11	650	ESL
o-Cresol	130	1	1%	55	55	--	--
p-Cresol	129	2	2%	4.7	110	--	--
Chrysene	167	3	2%	0.12	2.12	0.8	ESL
Dibenz(a,h)Anthracene	166	0	0%	0	--	0.25	ESL
Dibenzofuran	129	1	1%	90.8	90.8	--	--
1,2-Dichlorobenzene	130	0	0%	0	--	64.5	ESL
1,3-Dichlorobenzene	129	0	0%	0	--	65	ESL
1,4-Dichlorobenzene	130	0	0%	0	--	64.5	ESL
2,4-Dimethylphenol	130	1	1%	40	40	110	ESL
Di-n-Octyl Phthalate	130	1	1%	5.5	5.5	--	--
Fluoranthene	167	13	8%	0.1	12.8	8	ESL
Fluorene	167	10	6%	0.14	100	30	ESL
HpCDD	80	0	0%	0	--	--	--
HpCDF	80	0	0%	0	--	--	--
HxCDD	80	0	0%	0	--	--	--
Indeno(1,2,3-cd)Pyrene	167	0	0%	0	--	0.265	ESL
2-Methylnaphthalene	138	7	5%	6	108	30	ESL
Naphthalene	167	25	15%	0.16	322	62	ESL
Nitrobenzene	129	1	1%	23.1	23.1	--	--
OCDD	80	0	0%	0	--	--	--
OCDF	80	0	0%	0	--	--	--
Pentachlorophenol	130	0	0%	0	--	7.9	ESL
Phenanthrene	167	16	10%	0.11	114	4.6	ESL
Phenol	130	2	2%	14	27	256	ESL
Pyrene	166	15	9%	0.1	12	67.5	ESL
1,2,4-Trichlorobenzene	129	0	0%	0	--	65	ESL
PCBs							
PCB 1248	49	0	0%	0	--	0.03	ESL
PCB 1254	50	0	0%	0	--	0.03	ESL
PCB 1260	59	0	0%	0	--	0.03	ESL
Pesticides and Herbicides							
Aldrin	46	1	2%	0.33	0.33	0.13	ESL
Beta-BHC	45	2	4%	0.5	0.9	--	--
Chlordane (d)	45	1	2%	0.9	0.9	0.004	ESL
DDD	48	21	44%	0.099	18	0.001	ESL
DDE	48	8	17%	0.2	7.8	0.001	ESL
DDT	48	2	4%	0.11	1.6	0.001	ESL
Endosulfan II (e)	45	1	2%	0.3	0.3	0.0087	ESL
Endrin Ketone (f)	4	0	0%	0	--	0.0023	ESL
Lindane	45	0	0%	0	--	0.016	ESL

TABLE 1
SUMMARY OF GROUNDWATER DATA
Oakland Harbor Partners, LLC, Oakland, California

Chemical (a)	Groundwater						Screening Level Based on Surface Water Protection (ug/L) (c)
	Number of Samples Analyzed	Number of Detections	Frequency of Detection	Minimum Detection (ug/L)	Maximum Detection (ug/L) (b)		
TPH							
TPH as Gasoline	353	108	31%	51	48,900,000	5,000	ESL
TPH as Diesel	632	325	51%	50	620,000	2,500	ESL
TPH as Motor Oil	489	121	25%	50	26,000	2,500	ESL
TPH as Bunker C	34	11	32%	500	34,000	2,500	ESL
Oil and Grease	57	11	19%	5000	330,000	--	--

Abbreviations:

Beta-BHC = beta-Hexachlorocyclohexane	PCBs = Polychlorinated biphenyls
DDD = p,p'-Dichlorodiphenyldichloroethane	RWQCB = Regional Water Quality Control Board
DDE = p,p'-Dichlorodiphenyldichloroethene	SVOCs = Semi-volatile organic compounds
DDT = p,p'-Dichlorodiphenyltrichloroethane	TIC = Tentatively Identified Compound
HpCDF = Total heptachlorodibenzofuran	TPH = Total petroleum hydrocarbons
HxCDD = Total hexachlorodibenzo-p-dioxin	ug/L = Micrograms per liter
OCDD = Octachlorodibenzo-p-dioxin	U.S. EPA = U.S. Environmental Protection Agency
OCDF = Octachlorodibenzofuran	VOCs = Volatile organic compounds
PAHs = Polycyclic aromatic hydrocarbons	

"--" = not applicable, no screening levels are available, or no data exist for the chemical because sample matrix was not analyzed for chemical or it was not detected at concentrations greater than analytical method reporting limits

Notes:

- (a) Only those chemicals that have been detected at least once above analytical method reporting limits in soil, grab groundwater, groundwater, or soil gas samples collected from the Project Area are included in this table.
- (b) Bolded values indicate that the maximum detected concentration exceeded the respective screening level.
- (c) ESLs for marine surface water bodies in RWQCB's Screening for Environmental Concerns at Sites with Contaminated Soil and Groundwater, dated May 2008 (Table F-4a, RWQCB, 2008). The ceiling value presented in Table F-2b was selected as the screening level for a chemical when the lowest marine aquatic habitat goal in Table F-4a was based on drinking water or freshwater goals. U.S. EPA's Ambient Aquatic Life Water Quality Criteria for Tributyltin (U.S. EPA, 2003) was used as the screening criteria for dibutyltin and tributyltin in groundwater.
- (d) Detection in groundwater shown is for gamma-chlordane. Alpha-chordane was also detected at a concentration of 0.05 ug/L.
- (e) ESL shown is for endosulfan.
- (f) ESL shown is for endrin.

References:

RWQCB, 2008. *Screening for Environmental Concerns at Sites with Contaminated Soil and Groundwater*, California Regional Water Quality Control Board, San Francisco Bay Region, May 2008.
U.S. EPA, 2003. *Ambient Aquatic Life Water Quality Criteria for Tributyltin*, U.S. Environmental Protection Agency, December 2003.

Table 2
Summary of Soil Results for PCBs and Pesticides for the Wetlands Creation Area
Oakland Harbor Partners LLC, Oak-to-Ninth Development, Oakland, California

Sample Location	Sample ID	Sample Date	Sample Depth (feet, bgs)	Analytical Results (mg/kg) (a)(b)(c)(d)							
				PCBs			Pesticides				
				PCB 1248	PCB 1254	PCB 1260	DDD	DDE	DDT	Endrin Ketone	Lindane
Wetlands Creation Area											
DD-1	DD-1-0.5	9/3/2002	0.5	<0.05	<0.05	<0.05	<0.002	<0.002	<0.002	<0.002	<0.002
DD-2	DD-2-4	9/3/2002	4	<0.05	<0.05	<0.05	<0.002	<0.002	<0.002	<0.002	<0.002
OHP-PDD-SB29	PDDSB29(2.5-3)	2/2/2007	2.5-3	--	--	--	<0.01	<0.01	<0.01	--	<0.005
OHP-PDD-SB29	PDDSB29(7.5-8)	2/2/2007	7.5-8	--	--	--	<0.01	<0.01	<0.01	--	<0.005
OHP-PDD-SB32	PDDSB32(2-2.5)	2/5/2007	2-2.5	<0.1	<0.1	<0.1	<0.01	<0.01	<0.01	--	<0.005
OHP-PDD-SB32	PDDSB32(7-7.5)	2/5/2007	7-7.5	<0.1	<0.1	<0.1	--	--	--	--	--
OHP-PDD-SB33	PDDSB33(2-2.5)	2/5/2007	2-2.5	<0.1	<0.1	<0.1	<0.01	<0.01	<0.01	--	<0.005
OHP-PDD-SB33	PDDSB33(7-7.5)	2/5/2007	7-7.5	<0.1	<0.1	<0.1	--	--	--	--	--
OHP-PDD-SB34	PDDSB34(2-2.5)	2/5/2007	2-2.5	<0.1	<0.1	<0.1	<0.01	<0.01	<0.01	--	<0.005
OHP-PDD-SB34	PDDSB34(6-6.5)	2/5/2007	6-6.5	<0.1	<0.1	<0.1	--	--	--	--	--
OHP-PDD-SB35	PDDSB35(2-2.5)	2/5/2007	2-2.5	<0.1	<0.1	<0.1	<0.01	<0.01	<0.01	--	<0.005
OHP-PDD-SB35	PDDSB35(7.5-8)	2/5/2007	7.5-8	<0.1	<0.1	<0.1	--	--	--	--	--
OHP-PDD-SB37	PDDSB37(2-2.5)	2/5/2007	2-2.5	<0.1	<0.1	<0.1	<0.01	<0.01	<0.01	--	<0.005
OHP-PDD-SB37	PDDSB37(7.5-8)	2/5/2007	7.5-8	<0.1	<0.1	<0.1	--	--	--	--	--
OHP-PDD-SB39	PDDSB39(2-2.5)	2/5/2007	2-2.5	<0.1	<0.1	<0.1	0.047	0.0143	0.0352	--	<0.005
OHP-PDD-SB39	PDDSB39(7-7.5)	2/5/2007	7-7.5	<0.1	<0.1	<0.1	--	--	--	--	--
Maximum Detected Concentration				ND	ND	ND	0.047	0.0143	0.0352	ND	ND
Screening Level for Wetland Surface Material				0.0227	0.0227	0.0227	--	--	0.007	--	0.00078
Screening Level for Wetland Foundation Material				0.18	0.18	0.18	--	--	0.0461	--	--

Abbreviations:

"--" = Not available
< = Compound not detected at or above indicated laboratory detection limit
DDD = 1,1-dichloro-2, 2-bis(p-chlorophenyl)ethane
DDE = 1,1-dichloro-2, 2-bis(p-chlorophenyl)ethylene
DDT = 1,1,1-trichloro-2, 2-bis-(p-chlorophenyl)ethane
mg/kg = Milligrams per kilogram
ND = Analyte not detected above its laboratory reporting limit
PCBs = Polychlorinated Biphenyls

Notes:

- (a) Data presented herein were collected during multiple investigations and were analyzed by different laboratories.
- (b) Only samples that were analyzed for PCBs or pesticides are shown herein. Other PCBs and pesticides that have been detected above laboratory reporting limits.
- (c) Data from soil samples that were excavated as part of remedial activities are not included herein.
- (d) Screening levels from Table 4 of the May 2000 *Draft Staff Report, Beneficial Reuse of Dredged Materials: Sediment Screening and Testing Guidelines*. Detected concentrations that exceed the screening levels are shown in bold.

Table 3
Summary of Soil Results for PAHs for the Wetlands Creation Area
Oakland Harbor Partners LLC, Oak-to-Ninth Development, Oakland, California

Sample Location	Sample ID	Sample Date	Sample Depth (feet, bgs)	Analytical Results (mg/kg) (a)(b)(c)(d)																			
				PAHs																			
				Acenaphthene	Acenaphthylene	Anthracene	Benzo(a)Anthracene	Benzo(a)Pyrene	Benzo(b)Fluoranthene	Benzo(g,h,i)Perylene	Benzo(k)Fluoranthene	Chrysene	Dibenz(a,h)Anthracene	Fluoranthene	Fluorene	Indeno(1,2,3-cd)Pyrene	2-Methylnaphthalene	Naphthalene	Phenanthrene	Pyrene	Total BaP Equivalents	Total PAHs	
Wetlands Creation Area				DD-1	DD-1-0.5	9/3/2002	0.5	<0.01	<0.01	<0.005	<0.005	<0.005	<0.005	<0.01	<0.005	<0.005	<0.01	--	<0.015	<0.005	<0.005	ND	ND
	DD-1-8.5	9/3/2002	8.5	0.03	<0.01	0.0082	0.034	0.04	0.028	<0.01	<0.005	0.027	<0.01	0.085	<0.005	<0.01	--	<0.015	0.038	0.088	0.04647	0.3782	
	DD-2	9/3/2002	4	<0.01	<0.01	<0.005	<0.005	<0.005	<0.005	<0.01	<0.005	<0.005	<0.01	<0.005	<0.005	<0.01	--	<0.015	<0.005	<0.005	ND	ND	
OHP-PDD-SB29	PDDSB29(2.5-3)	2/2/2007	2.5-3	<0.05	<0.05	<0.05	<0.05	<0.05	<0.05	<0.05	<0.05	<0.05	<0.05	<0.05	<0.05	<0.05	<0.33	<0.05	<0.05	<0.05	ND	ND	
OHP-PDD-SB29	PDDSB29(7.5-8)	2/2/2007	7.5-8	<0.05	<0.05	<0.05	<0.05	<0.05	<0.05	<0.05	<0.05	<0.05	<0.05	<0.05	<0.05	<0.05	<0.33	<0.05	<0.05	<0.05	ND	ND	
OHP-PDD-SB32	PDDSB32(2-2.5)	2/5/2007	2-2.5	<0.05	<0.05	<0.05	<0.05	<0.05	<0.05	<0.05	<0.05	<0.05	<0.05	<0.05	<0.05	<0.33	<0.05	<0.05	<0.05	ND	ND		
OHP-PDD-SB32	PDDSB32(7-7.5)	2/5/2007	7-7.5	0.0769	<0.05	0.0638	0.24	0.206	0.25	0.145	0.284	0.522	<0.05	0.184	<0.05	0.11	<0.33	<0.05	<0.05	1.6	0.29962	3.6817	
OHP-PDD-SB33	PDDSB33(2-2.5)	2/5/2007	2-2.5	0.768	<0.25	2.49	12	21.9	17.1	14	17	15.7	4.03	27.7	0.412	12.1	<1.65	<0.25	8.3	35.1	31.907	188.6	
OHP-PDD-SB33	PDDSB33(7-7.5)	2/5/2007	7-7.5	<0.05	<0.05	<0.05	<0.05	<0.05	<0.05	<0.05	<0.05	0.0512	<0.05	0.0507	<0.05	<0.33	<0.05	<0.05	0.058	0.000512	0.1599		
OHP-PDD-SB34	PDDSB34(2-2.5)	2/5/2007	2-2.5	<0.05	<0.05	<0.05	<0.05	<0.05	<0.05	<0.05	<0.05	<0.05	<0.05	<0.05	<0.05	<0.33	<0.05	<0.05	<0.05	ND	ND		
OHP-PDD-SB34	PDDSB34(6-6.5)	2/5/2007	6-6.5	<0.05	<0.05	<0.05	<0.05	<0.05	<0.05	<0.05	<0.05	0.0573	<0.05	0.0503	<0.05	<0.33	<0.05	<0.05	0.0639	0.000573	0.1715		
OHP-PDD-SB35	PDDSB35(2-2.5)	2/5/2007	2-2.5	<0.05	<0.05	<0.05	<0.05	<0.05	<0.05	<0.05	<0.05	<0.05	<0.05	<0.05	<0.05	<0.33	<0.05	<0.05	<0.05	ND	ND		
OHP-PDD-SB35	PDDSB35(7.5-8)	2/5/2007	7.5-8	<0.05	<0.05	<0.05	<0.05	<0.05	<0.05	<0.05	<0.05	<0.05	<0.05	<0.05	<0.05	<0.33	<0.05	<0.05	0.0869	ND	0.0869		
OHP-PDD-SB37	PDDSB37(2-2.5)	2/5/2007	2-2.5	<0.05	<0.05	<0.05	<0.05	<0.05	<0.05	<0.05	<0.05	<0.05	<0.05	<0.05	<0.05	<0.33	<0.05	<0.05	<0.05	ND	ND		
OHP-PDD-SB37	PDDSB37(7.5-8)	2/5/2007	7.5-8	<0.05	<0.05	<0.05	<0.05	<0.05	<0.05	<0.05	<0.05	<0.05	<0.05	<0.05	<0.05	<0.33	<0.05	<0.05	<0.05	ND	ND		
OHP-PDD-SB39	PDDSB39(2-2.5)	2/5/2007	2-2.5	<0.05	<0.05	<0.05	<0.05	<0.05	<0.05	<0.05	<0.05	0.258	<0.05	<0.05	<0.05	<1.65	<0.05	<0.05	0.0667	0.00258	0.3247		
OHP-PDD-SB39	PDDSB39(7-7.5)	2/5/2007	7-7.5	<0.05	<0.05	<0.05	<0.05	0.0608	<0.05	<0.05	<0.05	<0.05	<0.05	<0.05	<0.05	<0.33	<0.05	<0.05	<0.05	0.0608	0.0608		
OHP-PDD-SB40	PDDSB40(5-5.5)	3/14/2007	5-5.5	<0.05	<0.05	<0.05	<0.05	<0.05	<0.05	<0.05	<0.05	<0.05	<0.05	<0.05	<0.05	<0.33	<0.05	<0.05	<0.05	ND	ND		
OHP-PDD-SB40	PDDSB40(6.5-7)	3/14/2007	6.5-7	<0.05	<0.05	<0.05	<0.05	<0.05	<0.05	<0.05	<0.05	<0.05	<0.05	<0.05	<0.05	<0.33	<0.05	<0.05	<0.05	ND	ND		
Maximum Detected Concentration				0.768	ND	2.49	12	21.9	17.1	14	17	15.7	4.03	27.7	0.412	12.1	ND	ND	8.3	35.1	31.907	188.6	
Screening Level for Wetland Surface Material				0.026	0.088	0.088	0.412	0.371	0.371	0.31	0.258	0.289	0.0327	0.514	0.0253	0.382	0.0194	0.0558	0.237	0.665	--	3.39	
Screening Level for Wetland Foundation Material				0.5	0.64	1.1	1.6	1.6	--	--	--	2.8	0.26	5.1	0.54	--	0.67	2.1	1.5	2.6	--	44.792	

Abbreviations:

- "--" = Not available
- < = Compound not detected at or above indicated laboratory detection limit
- BaP = Benzo(a)pyrene
- bgs = below ground surface
- J = Estimated value
- mg/kg = Milligrams per kilogram
- ND = Analyte not detected above its laboratory reporting limit
- PAHs = Polycyclic aromatic hydrocarbons

Notes:

- (a) Data presented herein were collected during different investigations and were analyzed by different laboratories.
- (b) Only samples that were analyzed for PAHs are shown herein.
- (c) Data from soil samples that were excavated as part of remedial activities are not included herein.
- (d) Screening levels from Table 4 of the May 2000 *Draft Staff Report, Beneficial Reuse of Dredged Materials: Sediment Screening and Testing Guidelines*. Detected concentrations that exceed the screening levels are shown in bold.

ATTACHMENT 5

**Waste Discharge Requirements
and
Water Quality Certification
Oak to Ninth Project
City of Oakland, Alameda County**

**Assessment of the Habitat Value of Pier Pilings
(Zabin, 2011)**

**An Assessment of the Habitat Value of Pier Pilings at the Ninth Avenue Wharf and
Vicinity and Recommendations for the Oak to Ninth Project**

Prepared for:

**LSA Associates, Inc.
157 Park Place
Point Richmond, CA 94801
(510) 236-6810**

Prepared by:

**Chela Zabin, PhD
170 W. Cliff Drive #58
Santa Cruz, CA 95060
(415) 272-9142**

May 15, 2011

Table of Contents

Objectives.....	3
Background.....	3
Survey Methods.....	4
Findings.....	4
Discussion.....	5
References.....	7

List of Figures

Figure 1. Broken pilings, hanging from the pier, were typical at the Ninth Avenue Wharf.....	8
Figure 2. Many of the pilings at the Ninth Avenue Wharf are coated in creosote.....	9
Figure 3. The native brown rockweed <i>Fucus gardneri</i> is plentiful in the intertidal zone rip-rap at the site.....	9
Figure 4. Barnacles dominate the pilings in the high intertidal zone at the site; native oysters, mussels and limpets are also present.....	10

Objectives

The objectives of this report are 1) to provide a qualitative assessment of the habitat value of two sets of pier pilings that are proposed for demolition, and 2) make recommendations for the provision of habitat that might be lost by the removal of the pilings.

Background

The proposed removal of the pier pilings and pier is part of the planned Oak to Ninth Avenue Project, an extensive mixed-use development of 66 acres along Oakland's waterfront. The proposed project includes 3,100 housing units, 200,000 square feet of commercial and retail space, two new marinas with 175 slips, 32 acres of public parks and open space, and a Maritime Museum at the old Ninth Avenue Terminal building.

Shoreline improvements are proposed as part of the development. These include the demolition of a timber wharf at Shoreline Park West, which is in disrepair and unsafe for public use. The wharf removal is being proposed as a compensation for fill that will be placed in the Bay as part of shoreline improvements elsewhere on the project site. In addition, a portion of the Ninth Avenue Wharf (just east of Shoreline Park West) will be removed as part of a structural and seismic retrofit. The project proposes to remove 1194 wooden pier pilings at Shoreline Park West and 1230 pier pilings at the Ninth Avenue Wharf (Neil Nichols, Moffatt and Nichol, personal communication to Steve Granholm, February 22, 2011).

A wetland mitigation plan for the project envisions the creation of tidal marsh and adjacent shoreline improvements to stabilize the shoreline, increase native plant cover and provide improved habitat for use by native water birds and other wildlife. The plan calls for removal of the wharf at Shoreline Park West and part of the Ninth Avenue Wharf to decrease shadow fill and increase habitat for shorebirds, waterfowl, and marine mammals. In addition, the rip-rap along the shoreline at Shoreline Park West, which consists of scrap cement and other dumped materials, will be replaced with a more visually appealing substrate (new rock rip-rap).

Survey Methods

I visited the site by boat on December 13, 2010 with Stuart Mook (Garcia and Associates), Steve Granholm (LSA Associates) and Matt Ricketts (LSA Associates). To examine the use of the pier pilings by marine animals and algae, we surveyed the pilings from the boat for about 3 hours centered around the low tide, which was 2.2 ft at 12:30. There was little wind, and we were able to see ~1-2 ft below the water's surface. The boat was able to nose in between sets of pilings, and to cruise slowly parallel to the outside of the pier, so that we could stop frequently to visually examine the pilings. We recorded all species of marine invertebrates and algae observed.

In addition, we assessed whether the outermost (bayside) pilings and the pilings further under the pier (shore side) differed in fouling community composition (i.e. marine invertebrates and algae) and whether pilings on different sides of the pier structure (Shoreline Park West and Ninth Avenue Wharf) were different from one another, in terms of the substrate and the fouling community.

Organisms that could be visually identified were recorded in a field notebook and photographed *in situ*. We also collected algae and invertebrates from pilings and a buoy for later identification. These were keyed to the lowest possible taxonomic level at the Romberg Tiburon Center using Light's Manual and in consultation with taxonomic experts.

Findings

On the whole, the pilings near Shoreline Park West were in a state of disrepair. Many were broken and hanging loose from the pier; in other cases only submerged stumps remained (Fig 1). Some of the pilings had been wrapped with PVC. It was difficult to tell whether all of the pilings had a creosote coating, but many of the ones we saw clearly had some creosote (Fig 2).

The Ninth Avenue Wharf reportedly has both concrete and green timber (non-creosoted) pilings (Moffatt and Nichol 2006). The timber pilings on the bayside edge support a timber apron, which will be removed as part of the retrofit. The pilings we were able to inspect were the outermost 2-3 rows of timber pilings. Some of these appeared to be covered in creosote.

Because we could not access pilings further under the wharf structures, we cannot be sure about the fouling community composition, but we saw little obvious difference in species cover and composition between pilings at the outer edge of the pier and those several rows under the pier. There was little algal cover and this tended to be found only on the outer row; with the exception of a few patchily distributed organisms, the animal species appeared similar on all pilings examined.

Macroalgal cover appeared to be limited to small patches of *Ulva* spp. and small amounts of a tufty red alga tentatively identified as the non-native *Caulacanthus okamurae*. A native red alga *Gratelopia lanceolata* and a non-native *Lomentaria hakodatensis* were found on the buoy we inspected, but not on the pilings. These species are common on floating docks throughout the Bay (pers. obs.). The native brown rockweed *Fucus distichus* was abundant on the shoreline rip-rap in the areas surrounding the pilings (Fig. 3), but was not found on the pilings themselves.

Invertebrate animals were the numerically dominant organisms on the pilings. Barnacles (*Balanus crenatus* and *Amphibalanus amphitrite*) were by far the most abundant organisms (in

the 100s-1000s of individuals/piling) above and just below the waterline. Mussels (*Mytilus* spp.), native oysters (*Ostrea lurida*) and limpets were also common (10s of individuals/piling) (Fig. 4). Large numbers (100s of individuals) of the large non-native solitary tunicate *Styela clava* were found on some of the pilings; there were also a few pilings that had significant cover of the non-native colonial tunicate *Didemnum* sp.

Other species observed included the nudibranchs *Dialula sandiegensis* and *Anisodoris nobilis*, the solitary tunicates *Ascidia zara* and *Ciona* sp., the limpet *Lottia limulata*, the bryozoans *Scrupocellaria diegensis*, *Bugula* sp. and *Watersipora* sp., a yellow sponge (likely *Halicondria* sp.), the orange finger sponge *Clathria prolifera*, kelp crabs (*Pugettia* spp.), grapsid crabs, tubeworms and chitons.

While herring will use many types of hard substrate for egg attachment, herring have not been reported far into the Oakland harbor and are unlikely to use this site (personal communication, Ryan Bartling, California Department of Fish and Game, January 2011).

Discussion

The recently released San Francisco Bay Subtidal Habitat Goals Report (2010) recommends the removal of derelict creosote pilings, both for aesthetic and environmental reasons. Such structures have negative or minimal beneficial habitat functions, because they provide habitat for numerous non-native fouling species, contain toxic compounds that may affect Pacific herring as well as other native fish and invertebrate species living on or near pilings, and alter water flow. Fouling communities that assemble on homogeneous, vertical substrates (such as pilings) are substantially different from those that assemble on more horizontal structures, such as rocky reefs (e.g. see Knott et al. 2004). On the other hand, pilings, rip-rap, seawalls, and other artificial hard substrates also can provide substantial settlement space for some native species, such as native oysters, which are themselves the target of restoration efforts.

The proposed removal of pilings and wharf structures at Shoreline Park West and the Ninth Avenue Wharf will provide two ecological benefits: (1) removing a source of toxic material and (2) eliminating a habitat for non-native species. These improvements will also return this segment of shoreline to a more aesthetically pleasing and natural configuration and increase its use by native birds and wildlife.

The disadvantage to piling removal is the loss of hard substrate habitat for native species such as oysters, mussels, limpets and other hard-substrate dependent grazing gastropods. The San Francisco Bay Subtidal Habitat Goals Report (2010) recommends the protection and

enhancement of native oyster populations. With these facts in mind, the following recommendations are proposed:

1. Where feasible, extend the placement of suitable heterogeneous hard substrate (such as stone rip rap, preferably native source, or Reef Balls¹) from the shoreline into the shallow subtidal (2-3 m below MLLW). This will provide habitat for native shoreline species dependent on hard substrate. Such substrate could be incorporated into the shoreline erosion protection design and could be integrated in a living shoreline approach that includes shoreline softening and restoration of native upland and marsh vegetation.
2. Where replacement of existing rip-rap and other hard intertidal structures is planned, take actions to preserve the *Fucus* currently growing along the shoreline edges. Such actions could include incorporating pieces of the existing rip-rap with *Fucus* attached to them into the new seawall, or transplanting adults following methods such as those being developed by Peter Raimondi's laboratory (University of California, Santa Cruz). Fleshy macroalgae like *Fucus* provide habitat for native fish, invertebrates and other algae, and may facilitate other organisms such as native oysters in the intertidal zone by mitigating heat stress (see Whittaker et al. 2010 and references therein). Populations of *Fucus* may be difficult to regain once lost, as their propagules have a limited dispersal distance (Sousa 1984, Stekoll and Deysher 1996).
3. Removal of creosote pilings may resuspend toxins. Recommendations for removal methods that minimize release of toxins are discussed in two recently released reports: Removal of Creosote-Treated Pilings and Structures from San Francisco Bay (Werme et al. 2010) and San Francisco Bay Subtidal Habitat Goals Report (California State Coastal Conservancy and Ocean Protection Council et al. 2010).

¹ <http://www.reefball.org/>

References

Knott NA, AJ Underwood, MG Chapman and TM Glasby. 2004. Epibiota on vertical and on horizontal surfaces on natural reefs and on artificial structures. *Journal of the Marine Biological Association of the United Kingdom* 86(6): 1117-1130.

Moffatt & Nichol. 2006. Oak to Ninth Avenue Development Proposed Shoreline Improvements. Report prepared for Signature Properties. 67 pp.

California State Coastal Conservancy and Ocean Protection Council, NOAA National Marine Fisheries Service and Restoration Center, San Francisco Bay Conservation and Development Commission, and San Francisco Estuary Partnership. 2010. San Francisco Bay Subtidal Habitat Goals Report: Conservation Planning for the Submerged Areas of the Bay. 50-Year Conservation Plan. 180 pp.

Sousa WP. 1984. Intertidal mosaics: patch size, propagule availability, and spatially variable patterns of succession. *Ecology* 65:1918-1935.

Stekoll MS and L Deysner. 1996. Recolonization and restoration of upper intertidal *Fucus gardneri* (Fucales, Phaeophyta) following the Exxon Valdez oil spill. *Hydrobiologia* 326/327: 331-316.

Werme C, J Hunt, E Beller, K Cayce, M Klatt, A Melwani, E Polson and R Grossinger. 2010. Removal of Creosote-Treated Pilings and Structures from San Francisco Bay. San Francisco Estuary Institute. Report to the California Coastal Conservancy. 24 pp., plus appendices.

Whittaker SG, Smith JR and Murray SN. 2010. Reestablishment of the Southern California Rocky Intertidal Brown Alga, *Silvetia compressa*: An experimental investigation of techniques and biotic and abiotic factors that affect restoration success. *Restoration Ecology* 18 (S1): 18-26.

Figures



Figure 1. Broken pilings, hanging from the pier, were typical at the Ninth Avenue Wharf.



Figure 2. Many of the pilings at the Ninth Avenue Wharf are coated in creosote.



Figure 3. The native brown rockweed *Fucus gardneri* is plentiful in the intertidal zone rip-rap at the site.



Figure 4. Barnacles dominate the pilings in the high intertidal zone at the site; native oysters, mussels and limpets are also present.