

*Prepared for:*

**Rancho Mission Viejo**  
P.O. Box 9  
San Juan Capistrano, CA 92693

**RANCHO MISSION VIEJO  
CONCEPTUAL WATER QUALITY  
MANAGEMENT PLAN**

*Prepared by:*



**GeoSyntec Consultants, Inc.**  
475 14th Street, Suite 450  
Oakland, CA 94612  
(510) 836-3034

Project Number: PW0087  
June 7, 2004



## Table of Contents

<b>1</b>	<b>INTRODUCTION AND WATERSHED ENVIRONMENTAL SETTING.....</b>	<b>1</b>
<b>1.1</b>	<b>Role of the Water Quality Management Plan in the Coordinated Planning Process</b>	<b>1</b>
<b>1.2</b>	<b>Watershed Planning</b>	<b>4</b>
1.2.1	SAMP.....	4
1.2.2	NCCP.....	6
<b>1.3</b>	<b>The Role of the Water Quality Management Plan in Supporting the GPA/ZC</b>	<b>7</b>
<b>1.4</b>	<b>Geographic Area Addressed by the Water Quality Management Plan</b>	<b>7</b>
<b>1.5</b>	<b>Analytical Approach Employed in Formulating the Conceptual WQMP</b>	<b>8</b>
<b>1.6</b>	<b>Conceptual WQMP Content and Organization</b>	<b>10</b>
<b>1.7</b>	<b>Environmental Setting</b>	<b>16</b>
1.7.1	Physical Setting.....	16
1.7.2	Climatic Conditions.....	17
1.7.3	Geomorphology, Terrains, and Hydrology.....	17
1.7.4	Water Quality.....	19
1.7.5	Biological Resources.....	29
<b>1.8</b>	<b>Regulatory Setting</b>	<b>29</b>
1.8.1	Clean Water Act.....	29
1.8.2	California Porter-Cologne Act.....	32
1.8.3	State of California Nonpoint Source Plan.....	34
1.8.4	Municipal NPDES Permit.....	36
1.8.5	CDFG Code 1601/1603.....	37
1.8.6	Endangered Species.....	38
<b>2</b>	<b>POLLUTANTS OF CONCERN AND HYDROLOGIC CONDITIONS OF CONCERN FOR THE SAN MATEO AND SAN JUAN WATERSHEDS.....</b>	<b>40</b>
<b>2.1</b>	<b>Overview</b>	<b>40</b>
2.1.1	Potential Effects of Development on Streamcourse Hydrologic and Geomorphic Processes.....	40
2.1.2	Potential Effects of Post-Development Surface and Subsurface Water Flows on Riparian Habitat.....	41
2.1.3	Potential Effects of Development on Pollutants.....	41
2.1.4	WQMP Approach to Addressing Potential Impacts of Stressors.....	42
<b>2.2</b>	<b>Hydrologic Conditions of Concern</b>	<b>45</b>
<b>2.3</b>	<b>Pollutants of Concern</b>	<b>46</b>
2.3.1	Pathogens.....	47
2.3.2	Sediment.....	48
2.3.3	Nutrients.....	48
2.3.4	Trace Metals.....	48
2.3.5	Petroleum Hydrocarbons/Oil and Grease.....	48
2.3.6	Pesticides.....	49
2.3.7	Trash & Debris.....	49
<b>2.4</b>	<b>Thresholds of Significance</b>	<b>49</b>
2.4.1	Significance Thresholds for Hydrologic Conditions of Concern Set Forth in the County of Orange LIP50	
2.4.2	Significance Thresholds for Pollutants of Concern.....	51
2.4.3	Significance Thresholds for Compliance with Plans, Policies, Regulations, and Permits.....	53

<b>3</b>	<b>WATER QUALITY AND FLOW CONTROL CONCEPT AND ANALYSIS</b>	
	<b>APPROACH.....</b>	<b>55</b>
<b>3.1</b>	<b>Overview</b>	<b>55</b>
3.1.1	Hydromodification .....	55
3.1.2	Local WQMP – Hydrologic Conditions of Concern .....	56
<b>3.2</b>	<b>Hydrologic Modeling</b>	<b>56</b>
<b>3.3</b>	<b>Water Balance and Flow Duration Analysis</b>	<b>58</b>
3.3.1	Water Balance Analysis.....	58
3.3.2	Flow Duration Analysis.....	61
<b>3.4</b>	<b>Combined Flow and Water Quality Control System</b>	<b>61</b>
3.4.1	Combined Control System Components.....	62
3.4.2	Sizing and Design of Flow Duration and Water Quality Basins .....	66
<b>3.5</b>	<b>Water Quality Analysis</b>	<b>70</b>
3.5.1	Surface Water .....	70
3.5.2	Groundwater Quality .....	71
<b>3.6</b>	<b>Spatial Scales of Analysis</b>	<b>72</b>
<b>4</b>	<b>WATER QUALITY MANAGEMENT PLAN ELEMENTS .....</b>	<b>74</b>
<b>4.1</b>	<b>General Water Quality Management Plan Elements</b>	<b>74</b>
4.1.1	BMP Selection.....	74
4.1.2	Site Design BMPs.....	75
4.1.3	Source Control BMPs.....	79
4.1.4	Stormwater BMP Operation and Maintenance Program .....	86
<b>4.2</b>	<b>WQMP for the Cañada Chiquita Sub-Basin</b>	<b>91</b>
4.2.1	Site Assessment .....	91
4.2.2	<i>Planning Considerations and Planning Recommendations</i> for Cañada Chiquita.....	93
4.2.3	Combined Control System: Elements and Sizes by Catchment .....	96
<b>4.3</b>	<b>WQMP for the Cañada gobernadora Sub-basin</b>	<b>100</b>
4.3.1	Site Assessment .....	100
4.3.2	<i>Planning Considerations and Planning Recommendations</i> for Cañada Gobernadora.....	102
4.3.3	Combined Control System: Elements and Sizes by Catchment .....	105
<b>4.4</b>	<b>WQMP for the Cental San Juan and Trampas Sub-basin</b>	<b>108</b>
4.4.1	Site Assessment .....	108
4.4.2	<i>Planning Considerations and Planning Recommendations</i> for the Central San Juan and Trampas Sub-basin	110
4.4.3	Combined Control System: Elements and Sizes by Planning Area – Alternative B-4 .....	112
4.4.4	Combined Control System: Elements and Sizes by Planning Area – Alternative B-9 .....	115
<b>4.5</b>	<b>WQMP for the Cristianitos Sub-basin</b>	<b>118</b>
4.5.1	Site Assessment .....	118
4.5.2	<i>Planning Considerations and Planning Recommendations</i> for the Cristianitos Sub-basin .....	120
4.5.3	Combined Control System: Elements and Sizes by Planning Area.....	122
<b>4.6</b>	<b>WQMP for the Gabino Portion of the Gabino and Blind Canyon Sub-basin</b>	<b>125</b>
4.6.1	Site Assessment.....	125
4.6.2	<i>Planning Considerations and Planning Recommendations</i> for the Gabino Sub-basin.....	129
4.6.3	Combined Control System: Elements and Sizes by Planning Area – Alternative B-4 .....	131
<b>4.7</b>	<b>WQMP for the Blind Canyon Portion of the Gabino and Blind Sub-basin and the Talega Sub-basin</b>	<b>134</b>
4.7.1	Site Assessment.....	134

4.7.2	<i>Planning Considerations and Planning Recommendations for the Blind Canyon Drainage Area and Talega Sub-basins</i> .....	137
4.7.3	Combined Control System: Elements and Sizes by Planning Area – Alternative B-4.....	138
4.7.4	Combined Control System: Elements and Sizes by Planning Area – Alternative B-9.....	142
<b>4.8</b>	<b>WQMP for the Verdugo Sub-basin</b> .....	<b>145</b>
4.8.1	Site Assessment.....	145
4.8.2	<i>Planning Considerations and Planning Recommendations for the Verdugo Sub-basin</i> .....	147
4.8.3	Combined Control System: Elements and Sizes by Planning Area.....	148
<b>4.9</b>	<b>WQMP for the Narrow &amp; Lower San Juan Sub-basin and the Lower Cristianitos Sub-basin</b> .....	<b>151</b>
4.9.1	Narrow and Lower San Juan Sub-basin.....	151
4.9.2	Lower Cristianitos Sub-basin.....	153
<b>5</b>	<b>IMPACT ANALYSIS</b> .....	<b>154</b>
<b>5.1</b>	<b>Generalized Impacts</b> .....	<b>154</b>
5.1.1	Selected Pollutants of Concern.....	154
5.1.2	Groundwater Impacts.....	160
5.1.3	Construction-Related Impacts.....	160
5.1.4	Compliance with Plans, Policies, Regulations, and Permits.....	161
<b>5.2</b>	<b>Impact Analysis for the Cañada Chiquita Sub-basin</b> .....	<b>162</b>
5.2.1	Impacts on Hydrologic Conditions of Concern.....	163
5.2.2	Impacts on Pollutants of Concern – Alternative B-4.....	171
5.2.3	Impacts on Pollutants of Concern – Alternative B-9.....	180
5.2.4	Findings of Significance.....	180
<b>5.3</b>	<b>Impact Analysis for the Cañada Gobernadora Sub-basin</b> .....	<b>184</b>
5.3.1	Impacts on Hydrologic Conditions of Concern.....	185
5.3.2	Impacts on Pollutants of Concern – Alternative B-4.....	192
5.3.3	Impacts on Pollutants of Concern – Alternative B-9.....	201
5.3.4	Findings of Significance.....	202
<b>5.4</b>	<b>Impact Analysis for the Central San Juan and Trampas Sub-basin</b> .....	<b>206</b>
5.4.1	Impacts on Hydrologic Conditions of Concern.....	206
5.4.2	Impacts on Pollutants of Concern – Alternative B-4.....	216
5.4.3	Impacts on Pollutants of Concern – Alternative B-9.....	224
5.4.4	Findings of Significance.....	229
<b>5.5</b>	<b>Impact Analysis for the Cristianitos Sub-basin</b> .....	<b>233</b>
5.5.1	Impacts on Hydrologic Conditions of Concern.....	234
5.5.2	Impacts on Pollutants of Concern.....	240
5.5.3	Findings of Significance.....	245
<b>5.6</b>	<b>Impact Analysis for the Gabino Sub-basin</b> .....	<b>248</b>
5.6.1	Impacts on Hydrologic Conditions of Concern.....	248
5.6.2	Impacts on Pollutants of Concern.....	250
5.6.3	Findings of Significance.....	256
5.6.4	Impacts Associated with Proposed Development in Upper Gabino.....	259
<b>5.7</b>	<b>Impact Analysis for the Blind and Talega Sub-basins</b> .....	<b>260</b>
5.7.1	Impacts on Hydrologic Conditions of Concern.....	260
5.7.2	Impacts on Pollutants of Concern – Alternative B-4.....	266
5.7.3	Impacts on Pollutants of Concern – Alternative B-9.....	273
5.7.4	Findings of Significance.....	280
<b>5.8</b>	<b>Impact Analysis for the Verdugo Sub-basin</b> .....	<b>284</b>

5.8.1	B4 Alternative .....	284
5.8.2	B9 Alternative .....	285
5.8.3	Impacts on Hydrologic Conditions of Concern .....	285
5.8.4	Impacts on Pollutants of Concern.....	288
5.8.5	Findings of Significance.....	292
<b>5.9</b>	<b>Impact Analysis for the Narrow and Lower Central San Juan Sub-basin and the Lower Cristianitos Sub-basin</b>	<b>294</b>
5.9.1	Narrow and Lower San Juan Sub-basin.....	295
5.9.2	Lower Cristianitos Sub-basin .....	297
<b>6</b>	<b>LONG TERM ADAPTIVE MANAGEMENT .....</b>	<b>299</b>
<b>6.1</b>	<b>Combined Control System Component Inspection and Performance Monitoring</b>	<b>299</b>
6.1.1	Wet Weather Monitoring.....	300
6.1.2	Dry Weather Monitoring .....	300
<b>6.2</b>	<b>Hydrologic Monitoring</b>	<b>300</b>
<b>6.3</b>	<b>WQMP Evaluation and Corrective Measures</b>	<b>301</b>
<b>6.4</b>	<b>Documentation and Reporting</b>	<b>304</b>
<b>7</b>	<b>IMPACTS OF OTHER ALTERNATIVES .....</b>	<b>305</b>
<b>7.1</b>	<b>Descriptions of Alternatives</b>	<b>305</b>
7.1.1	Alternative B-5 .....	308
7.1.2	Alternative B-6.....	308
7.1.3	Alternative B-8.....	308
7.1.4	Alternative B-10.....	309
7.1.5	Alternative B-11 .....	310
<b>7.2</b>	<b>Approach to Evaluating Impacts</b>	<b>310</b>
<b>7.3</b>	<b>Impacts Associated with the B-5 Alternative</b>	<b>311</b>
7.3.1	Effects on Hydrologic Conditions of Concern .....	311
7.3.2	Effects on Pollutants of Concern.....	312
<b>7.4</b>	<b>Impacts Associated with the B-6 Alternative</b>	<b>313</b>
7.4.1	Effects on Hydrologic Conditions of Concern .....	313
7.4.2	Impacts on Pollutants of Concern.....	314
<b>7.5</b>	<b>Impacts Associated with the B-8 Alternative</b>	<b>315</b>
<b>7.6</b>	<b>Impacts Associated with the B-10 Alternative</b>	<b>315</b>
7.6.1	Effects on Hydrologic Conditions of Concern .....	316
7.6.2	Impacts on Pollutants of Concern.....	316
<b>7.7</b>	<b>Impacts Associated with the B-11 Alternative</b>	<b>317</b>
7.7.1	Effects on Hydrologic Conditions of Concern .....	317
7.7.2	Impacts on Pollutants of Concern.....	317
<b>8</b>	<b>CUMULATIVE IMPACT ANALYSIS .....</b>	<b>319</b>
<b>8.1</b>	<b>San Juan Creek Watershed</b>	<b>319</b>
8.1.1	Stormwater Runoff Volume .....	319
8.1.2	Stormwater Runoff Pollutant Loads and Concentrations .....	320
<b>8.2</b>	<b>San Mateo Creek Watershed</b>	<b>322</b>
8.2.1	Stormwater Runoff Volumes.....	322
8.2.2	Stormwater Runoff Pollutant Loads and Concentrations .....	324

<b>8.3</b>	<b>Findings of Significance</b>	<b>326</b>
8.3.1	San Juan Creek Watershed .....	326
8.3.2	San Mateo Creek Watershed .....	326
<b>9</b>	<b>GLOSSARY .....</b>	<b>328</b>
<b>10</b>	<b>REFERENCES .....</b>	<b>333</b>

**Appendix A Continuous Hydrologic Simulation and Water Balance Analyses**

**Appendix B Water Quality Model Description**

**Appendix C Water Quality Monitoring Data**

**Appendix D Water Balance Results**

**Appendix E Ground Water Quality Impacts**

## List of Tables

TABLE 1-1: B-4 AND B-9 ALTERNATIVES PROPOSED LAND USE AREAS BY SUB-BASIN.....	9
TABLE 1-2: LIP WQMP TEMPLATE AND CONCEPTUAL WQMP ELEMENTS.....	11
TABLE 1-3: AVERAGE TSS CONCENTRATIONS FROM ORANGE COUNTY MONITORING, 1991-1999.....	22
TABLE 1-4: AVERAGE NITRATE CONCENTRATIONS FROM ORANGE COUNTY MONITORING, 1991-1999 (MG/L NO <sub>3</sub> AS N).....	23
TABLE 1-5: AVERAGE PHOSPHATE CONCENTRATIONS FROM ORANGE COUNTY MONITORING, 1991-1999 (MG/L PO <sub>4</sub> AS P).....	23
TABLE 1-6: AVERAGE TRACE METAL CONCENTRATIONS FROM ORANGE COUNTY MONITORING, 1991-1999.....	24
TABLE 1-7: SURFACE WATER MONITORING STATION LOCATIONS.....	26
TABLE 1-8: AVERAGE TSS CONCENTRATIONS DURING WET AND DRY WEATHER.....	26
TABLE 1-9: AVERAGE NUTRIENT CONCENTRATIONS DURING WET WEATHER.....	27
TABLE 1-10: AVERAGE NUTRIENT CONCENTRATIONS DURING DRY WEATHER.....	27
TABLE 1-11: FECAL COLIFORM DATA DURING STORM EVENTS.....	27
TABLE 1-12: FECAL COLIFORM DATA DURING DRY WEATHER.....	28
TABLE 1-13: AVERAGE TRACE METAL CONCENTRATIONS DURING WET WEATHER.....	28
TABLE 1-14: 2002 CWA SECTION 303(D) LISTINGS FOR THE SAN JUAN AND SAN MATEO WATERSHEDS.....	31
TABLE 1-15: BENEFICIAL USES OF RECEIVING WATERS.....	33
TABLE 2-1: HYDROLOGIC CONDITION OF CONCERN AND SIGNIFICANCE THRESHOLDS.....	51
TABLE 2-2: POLLUTANTS OF CONCERN AND SIGNIFICANCE THRESHOLDS FOR SURFACE WATER.....	52
TABLE 3-1: TREATMENT CONTROL BMP SELECTION MATRIX <sup>1</sup> .....	62
TABLE 3-2: POND DESIGN USING FLOW DURATION CONTROL.....	68
TABLE 3-3: DRAIN TIME AS FUNCTION OF STAGE IN FD/WQ BASIN.....	69
TABLE 4-1: IMPLEMENTATION OF SITE DESIGN BMPs.....	76
TABLE 4-2: ROUTINE NON-STRUCTURAL SOURCE CONTROL BMPs.....	79
TABLE 4-3: ROUTINE STRUCTURAL SOURCE CONTROL BMPs.....	82
TABLE 4-4: TYPICAL OPERATION & MAINTENANCE ACTIVITIES.....	87
TABLE 4-5: PROJECT LAND USES AND AREAS IN THE CHIQUITA SUB-BASIN.....	93
TABLE 4-6: INCORPORATION OF THE <i>PLANNING RECOMMENDATIONS</i> INTO BMP SELECTION FOR CAÑADA CHIQUITA.....	95
TABLE 4-7: COMBINED CONTROL SYSTEM REQUIREMENTS FOR CAÑADA CHIQUITA- ALTERNATIVE B-4.....	98
TABLE 4-8: COMBINED CONTROL SYSTEM FACILITIES AND SIZES IN CAÑADA CHIQUITA- ALTERNATIVE B-4.....	99
TABLE 4-9: LAND USES AND AREAS IN CAÑADA GOBERNADORA.....	102
TABLE 4-10: INCORPORATION OF THE <i>PLANNING RECOMMENDATIONS</i> INTO BMP SELECTION FOR CAÑADA GOBERNADORA.....	103
TABLE 4-11: COMBINED CONTROL SYSTEM REQUIREMENTS FOR CAÑADA GOBERNADORA- ALTERNATIVE B-4.....	107
TABLE 4-12: COMBINED CONTROL SYSTEM FACILITIES AND SIZES IN CAÑADA GOBERNADORA- ALTERNATIVE B-4.....	108
TABLE 4-13: LAND USES AND AREAS IN THE CENTRAL SAN JUAN AND TRAMPAS SUB-BASIN.....	110
TABLE 4-14: INCORPORATION OF THE <i>PLANNING RECOMMENDATIONS</i> INTO BMP SELECTION.....	111
TABLE 4-15: COMBINED CONTROL SYSTEM REQUIREMENTS FOR THE CENTRAL SAN JUAN AND TRAMPAS SUB-BASINS- ALTERNATIVE B-4.....	114
TABLE 4-16: COMBINED CONTROL SYSTEM FACILITIES AND SIZES IN CENTRAL SAN JUAN AND TRAMPAS SUB-BASIN- ALTERNATIVE B-4.....	115
TABLE 4-17: COMBINED CONTROL SYSTEM REQUIREMENTS FOR PA 4 IN THE CENTRAL SAN JUAN AND TRAMPAS SUB-BASINS- ALTERNATIVE B-9.....	117
TABLE 4-18: CONTROL SYSTEM FACILITIES AND SIZES FOR PA 4 IN CENTRAL SAN JUAN AND TRAMPAS SUB-BASIN- ALTERNATIVE B-9.....	118
TABLE 4-19: LAND USES AND AREAS IN THE CRISTIANITOS SUB-BASIN.....	120
TABLE 4-20: INCORPORATION OF THE <i>PLANNING RECOMMENDATIONS</i> INTO BMP SELECTION.....	121



TABLE 4-21: COMBINED CONTROL SYSTEM REQUIREMENTS FOR THE CRISTIANITOS SUB-BASIN- ALTERNATIVE B-4	124
TABLE 4-22: COMBINED CONTROL SYSTEM FACILITIES AND SIZES IN THE CRISTIANITOS SUB-BASIN- ALTERNATIVE B-4	125
TABLE 4-23: LAND USES AND AREAS IN THE GABINO SUB-BASIN	128
TABLE 4-24: INCORPORATION OF THE <i>PLANNING RECOMMENDATIONS</i> INTO BMP SELECTION	130
TABLE 4-25: COMBINED CONTROL SYSTEM REQUIREMENTS FOR GABINO- ALTERNATIVE B-4	133
TABLE 4-26: COMBINED CONTROL SYSTEM FACILITIES AND SIZES IN THE GABINO SUB-BASIN- ALTERNATIVE B-4	134
TABLE 4-27: LAND USES AND AREAS IN THE BLIND AND TALEGA SUB-BASINS	136
TABLE 4-28: INCORPORATION OF THE <i>PLANNING RECOMMENDATIONS</i> INTO BMP SELECTION	138
TABLE 4-29: COMBINED CONTROL SYSTEM REQUIREMENTS FOR BLIND CANYON- ALTERNATIVE B-4	141
TABLE 4-30: COMBINED CONTROL SYSTEM FACILITIES AND SIZES IN BLIND CANYON- ALTERNATIVE B-4	142
TABLE 4-31: COMBINED CONTROL SYSTEM REQUIREMENTS FOR BLIND CANYON- ALTERNATIVE B-9	144
TABLE 4-32: COMBINED CONTROL SYSTEM FACILITIES AND SIZES IN BLIND CANYON- ALTERNATIVE B-9	145
TABLE 4-33: LAND USES AND AREAS IN THE VERDUGO SUB-BASIN	147
TABLE 4-34: INCORPORATION OF THE <i>PLANNING RECOMMENDATIONS</i> INTO BMP SELECTION	148
TABLE 4-35: COMBINED CONTROL SYSTEM REQUIREMENTS FOR THE VERDUGO SUB-BASIN- ALTERNATIVE B-9	150
TABLE 4-36: COMBINED CONTROL SYSTEM FACILITIES AND SIZES THE VERDUGO SUB-BASIN- ALTERNATIVE B-9	151
TABLE 5-1: ALTERNATIVE B-4 CHIQUITA SUB-BASIN WATER BALANCE, ALL YEARS (INCHES (ACRE-FT))	166
TABLE 5-2: ALTERNATIVE B-4 CHIQUITA SUB-BASIN WATER BALANCE, DRY YEARS (INCHES (ACRE-FT))	167
TABLE 5-3: ALTERNATIVE B-4 CHIQUITA SUB-BASIN WATER BALANCE, WET YEARS (INCHES (ACRE-FT))	168
TABLE 5-4: PREDICTED AVERAGE ANNUAL TSS LOADS AND CONCENTRATIONS FOR THE CHIQUITA SUB-BASIN (ALTERNATIVE B-4)	172
TABLE 5-5: COMPARISON OF PREDICTED TSS CONCENTRATION WITH WATER QUALITY OBJECTIVES AND OBSERVED IN-STREAM CONCENTRATIONS FOR THE CHIQUITA SUB-BASIN (ALTERNATIVE B-4)	173
TABLE 5-6: PREDICTED AVERAGE ANNUAL NUTRIENT LOADS FOR THE CHIQUITA SUB-BASIN (ALTERNATIVE B-4) (LBS)	175
TABLE 5-7: PREDICTED AVERAGE ANNUAL NUTRIENT CONCENTRATIONS THE CHIQUITA SUB-BASIN (ALTERNATIVE B-4) (MG/L)	175
TABLE 5-8: COMPARISON OF PREDICTED NUTRIENT CONCENTRATIONS WITH OBSERVED IN-STREAM CONCENTRATIONS THE CHIQUITA SUB-BASIN (ALTERNATIVE B-4)	176
TABLE 5-9: PREDICTED AVERAGE ANNUAL TRACE METAL LOADS THE CHIQUITA SUB-BASIN (ALTERNATIVE B-4) (LBS)	178
TABLE 5-10: PREDICTED AVERAGE ANNUAL TRACE METAL CONCENTRATIONS THE CHIQUITA SUB-BASIN (ALTERNATIVE B-4) ( $\mu\text{G/L}$ )	179
TABLE 5-11: COMPARISON OF PREDICTED TRACE METALS CONCENTRATIONS WITH WATER QUALITY CRITERIA AND OBSERVED IN-STREAM CONCENTRATIONS THE CHIQUITA SUB-BASIN (ALTERNATIVE B-4)	180
TABLE 5-12: GOBERNADORA SUB-BASIN WATER BALANCE*, ALL YEARS (ALTERNATIVE B-4) (INCHES (ACRE-FT))	188
TABLE 5-13: GOBERNADORA SUB-BASIN WATER BALANCE*, DRY YEARS (ALTERNATIVE B-4) (INCHES (ACRE-FT))	189
TABLE 5-14: GOBERNADORA SUB-BASIN WATER BALANCE*, WET YEARS (ALTERNATIVE B-4) (INCHES (ACRE-FT))	190
TABLE 5-15: GOBERNADORA SUB-BASIN AVERAGE ANNUAL WATER BALANCE, UPPER/LOWER SUB-BASIN (ALTERNATIVE B-4) (ALL VALUES ARE ACRE-FT)	191
TABLE 5-16: EFFECTIVENESS OF GOBERNADORA MULTI-PURPOSE BASIN (ALTERNATIVE B-4) (INCHES (ACRE-FT))	191
TABLE 5-17: PREDICTED AVERAGE ANNUAL TSS LOADS AND CONCENTRATIONS FOR THE GOBERNADORA SUB-BASIN (ALTERNATIVE B-4)	193
TABLE 5-18: COMPARISON OF PREDICTED TSS CONCENTRATION WITH WATER QUALITY OBJECTIVES AND OBSERVED IN-STREAM CONCENTRATIONS FOR THE GOBERNADORA SUB-BASIN (ALTERNATIVE B-4)	194

TABLE 5-19: PREDICTED AVERAGE ANNUAL NUTRIENT LOADS FOR THE GOBERNADORA SUB-BASIN (ALTERNATIVE B-4) (LBS).....	195
TABLE 5-20: PREDICTED AVERAGE ANNUAL NUTRIENT CONCENTRATIONS FOR THE GOBERNADORA SUB-BASIN (ALTERNATIVE B-4) (MG/L) .....	196
TABLE 5-21: COMPARISON OF PREDICTED NUTRIENT CONCENTRATIONS WITH OBSERVED IN-STREAM CONCENTRATIONS FOR THE GOBERNADORA SUB-BASIN (ALTERNATIVE B-4) .....	197
TABLE 5-22: PREDICTED AVERAGE ANNUAL TRACE METAL LOADS FOR THE GOBERNADORA SUB-BASIN (ALTERNATIVE B-4) (LBS) .....	199
TABLE 5-23: PREDICTED AVERAGE ANNUAL TRACE METAL CONCENTRATIONS FOR THE GOBERNADORA SUB-BASIN (ALTERNATIVE B-4) (µG/L) .....	200
TABLE 5-24: COMPARISON OF PREDICTED TRACE METALS CONCENTRATIONS WITH WATER QUALITY CRITERIA AND OBSERVED IN-STREAM CONCENTRATIONS FOR THE GOBERNADORA SUB-BASIN (ALTERNATIVE B-4) .....	201
TABLE 5-25: CENTRAL SAN JUAN & TRAMPAS SUB-BASIN, WITH SAND MINE, AVERAGE ANNUAL WATER BALANCE, ALL YEARS (ALTERNATIVE B-4) (INCHES (ACRE-FT)) .....	211
TABLE 5-26: PLANNING AREA 5 IN CENTRAL SAN JUAN & TRAMPAS SUB-BASIN, WITHOUT SAND MINE <sup>1</sup> , AVERAGE ANNUAL WATER BALANCE, ALL YEARS (ALTERNATIVE B-4) (INCHES (ACRE-FT)) .....	211
TABLE 5-27: CENTRAL SAN JUAN & TRAMPAS SUB-BASIN, WITH SAND MINE, AVERAGE ANNUAL WATER BALANCE, DRY YEARS (ALTERNATIVE B-4) (INCHES (ACRE-FT)).....	212
TABLE 5-28: PLANNING AREA 5 IN CENTRAL SAN JUAN & TRAMPAS SUB-BASIN, WITHOUT SAND MINE <sup>1</sup> , AVERAGE ANNUAL WATER BALANCE, DRY YEARS (ALTERNATIVE B-4) (INCHES (ACRE-FT)).....	212
TABLE 5-29: SOUTH CENTRAL SAN JUAN (PA5) & TRAMPAS TRIBUTARY AREAS, WITH MINE, AVERAGE ANNUAL WATER BALANCE, WET YEARS (INCHES (ALTERNATIVE B-4) (ACRE-FT)) .....	213
TABLE 5-30: PLANNING AREA 5 IN CENTRAL SAN JUAN & TRAMPAS SUB-BASIN, PRE-MINE <sup>1</sup> , AVERAGE ANNUAL WATER BALANCE, WET YEARS (INCHES (ALTERNATIVE B-4) (ACRE-FT)) .....	213
TABLE 5-31: EAST CENTRAL SAN JUAN (PA 4) AVERAGE ANNUAL WATER BALANCE (ALTERNATIVE B-9) (INCHES (ACRE-FT)).....	215
TABLE 5-32: PREDICTED AVERAGE ANNUAL TSS LOADS AND CONCENTRATIONS FOR THE CENTRAL SAN JUAN AND TRAMPAS SUB-BASIN (ALTERNATIVE B-4).....	216
TABLE 5-33: COMPARISON OF PREDICTED TSS CONCENTRATION WITH WATER QUALITY OBJECTIVES AND OBSERVED IN-STREAM CONCENTRATIONS FOR THE CENTRAL SAN JUAN AND TRAMPAS SUB-BASIN (ALTERNATIVE B-4).....	217
TABLE 5-34: PREDICTED AVERAGE ANNUAL NUTRIENT LOADS FOR THE CENTRAL SAN JUAN AND TRAMPAS SUB-BASIN (ALTERNATIVE B-4) (LBS).....	218
TABLE 5-35: PREDICTED AVERAGE ANNUAL NUTRIENT CONCENTRATIONS FOR THE CENTRAL SAN JUAN AND TRAMPAS SUB-BASIN (ALTERNATIVE B-4) (MG/L).....	219
TABLE 5-36: COMPARISON OF PREDICTED NUTRIENT CONCENTRATIONS WITH OBSERVED IN-STREAM CONCENTRATIONS FOR THE CENTRAL SAN JUAN AND TRAMPAS SUB-BASIN (ALTERNATIVE B-4) .....	220
TABLE 5-37: PREDICTED AVERAGE ANNUAL TRACE METAL LOADS FOR THE CENTRAL SAN JUAN AND TRAMPAS SUB-BASIN (ALTERNATIVE B-4) (LBS).....	222
TABLE 5-38: PREDICTED AVERAGE ANNUAL TRACE METAL CONCENTRATIONS FOR THE CENTRAL SAN JUAN AND TRAMPAS SUB-BASIN (ALTERNATIVE B-4) (µG/L).....	223
TABLE 5-39: COMPARISON OF PREDICTED TRACE METALS CONCENTRATIONS WITH WATER QUALITY CRITERIA AND OBSERVED IN-STREAM CONCENTRATIONS FOR THE CENTRAL SAN JUAN AND TRAMPAS SUB-BASIN (ALTERNATIVE B-4) .....	224
TABLE 5-40: PREDICTED AVERAGE ANNUAL TSS LOADS AND CONCENTRATIONS FOR PLANNING AREA 4 WITHIN THE CENTRAL SAN JUAN AND TRAMPAS SUB-BASIN (ALTERNATIVE B-9) .....	225
TABLE 5-41: COMPARISON OF PREDICTED TSS CONCENTRATION WITH WATER QUALITY OBJECTIVES AND OBSERVED IN-STREAM CONCENTRATIONS FOR PLANNING AREA 4 IN THE CENTRAL SAN JUAN AND TRAMPAS SUB-BASIN (ALTERNATIVE B-9) .....	225
TABLE 5-42: PREDICTED AVERAGE ANNUAL NUTRIENT LOADS FOR PLANNING AREA 4 IN THE CENTRAL SAN JUAN AND TRAMPAS SUB-BASIN (ALTERNATIVE B-9) (LBS).....	226

TABLE 5-43: PREDICTED AVERAGE ANNUAL NUTRIENT CONCENTRATIONS FOR PLANNING AREA 4 IN THE CENTRAL SAN JUAN AND TRAMPAS SUB-BASIN (ALTERNATIVE B-9) (MG/L) .....	226
TABLE 5-44: COMPARISON OF PREDICTED NUTRIENT CONCENTRATIONS WITH OBSERVED IN-STREAM CONCENTRATIONS FOR PLANNING AREA 4 IN THE CENTRAL SAN JUAN AND TRAMPAS SUB-BASIN (ALTERNATIVE B-9) .....	227
TABLE 5-45: PREDICTED AVERAGE ANNUAL TRACE METAL LOADS FOR PLANNING AREA 4 IN THE CENTRAL SAN JUAN AND TRAMPAS SUB-BASIN (ALTERNATIVE B-9) (LBS).....	228
TABLE 5-46: PREDICTED AVERAGE ANNUAL TRACE METAL CONCENTRATIONS FOR PLANNING AREA 4 IN THE CENTRAL SAN JUAN AND TRAMPAS SUB-BASIN (ALTERNATIVE B-9) (µG/L) .....	228
TABLE 5-47: COMPARISON OF PREDICTED TRACE METALS CONCENTRATIONS WITH WATER QUALITY CRITERIA AND OBSERVED IN-STREAM CONCENTRATIONS FOR PLANNING AREA 4 IN THE CENTRAL SAN JUAN AND TRAMPAS SUB-BASIN (ALTERNATIVE B-9) .....	229
TABLE 5-48: CRISTIANITOS SUB-BASIN AVERAGE ANNUAL WATER BALANCE, ALL YEARS (ALTERNATIVE B-4) (INCHES (ACRE-FT)) .....	238
TABLE 5-49: CRISTIANITOS SUB-BASIN AVERAGE ANNUAL WATER BALANCE, DRY YEARS (ALTERNATIVE B-4) (INCHES (ACRE-FT)) .....	238
TABLE 5-50: CRISTIANITOS SUB-BASIN AVERAGE ANNUAL WATER BALANCE, WET YEARS (ALTERNATIVE B-4) (INCHES (ACRE-FT)) .....	239
TABLE 5-51: PREDICTED AVERAGE ANNUAL TSS LOADS AND CONCENTRATIONS FOR THE CRISTIANITOS SUB-BASIN (ALTERNATIVE B-4) .....	240
TABLE 5-52: COMPARISON OF PREDICTED TSS CONCENTRATION WITH WATER QUALITY OBJECTIVES AND OBSERVED IN-STREAM CONCENTRATIONS FOR THE CRISTIANITOS SUB-BASIN (ALTERNATIVE B-4) .....	241
TABLE 5-53: PREDICTED AVERAGE ANNUAL NUTRIENT LOADS FOR THE CRISTIANITOS SUB-BASIN (ALTERNATIVE B-4) (LBS).....	242
TABLE 5-54: PREDICTED AVERAGE ANNUAL NUTRIENT CONCENTRATIONS FOR THE CRISTIANITOS SUB-BASIN (ALTERNATIVE B-4) (MG/L).....	242
TABLE 5-55: COMPARISON OF PREDICTED NUTRIENT CONCENTRATIONS WITH OBSERVED IN-STREAM CONCENTRATIONS FOR THE CRISTIANITOS SUB-BASIN (ALTERNATIVE B-4) .....	243
TABLE 5-56: PREDICTED AVERAGE ANNUAL TRACE METAL LOADS FOR THE CRISTIANITOS SUB-BASIN (ALTERNATIVE B-4) (LBS) .....	244
TABLE 5-57: PREDICTED AVERAGE ANNUAL TRACE METAL CONCENTRATIONS FOR THE CRISTIANITOS SUB-BASIN (ALTERNATIVE B-4) (µG/L) .....	244
TABLE 5-58: COMPARISON OF PREDICTED TRACE METALS CONCENTRATIONS WITH WATER QUALITY CRITERIA AND OBSERVED IN-STREAM CONCENTRATIONS FOR THE CRISTIANITOS SUB-BASIN (ALTERNATIVE B-4) .....	245
TABLE 5-59: GABINO SUB-BASIN AVERAGE ANNUAL WATER BALANCE <sup>1</sup> (INCHES (ACRE-FT)).....	251
TABLE 5-60: PREDICTED AVERAGE ANNUAL TSS LOADS AND CONCENTRATIONS FOR THE GABINO SUB-BASIN (ALTERNATIVE B-4) .....	252
TABLE 5-61: COMPARISON OF PREDICTED TSS CONCENTRATION WITH WATER QUALITY OBJECTIVES AND OBSERVED IN-STREAM CONCENTRATIONS FOR THE GABINO SUB-BASIN (ALTERNATIVE B-4) .....	252
TABLE 5-62: PREDICTED AVERAGE ANNUAL NUTRIENT LOADS FOR THE GABINO SUB-BASIN (ALTERNATIVE B-4) (LBS).....	253
TABLE 5-63: PREDICTED AVERAGE ANNUAL NUTRIENT CONCENTRATIONS FOR THE GABINO SUB-BASIN (ALTERNATIVE B-4) (MG/L) .....	254
TABLE 5-64: COMPARISON OF PREDICTED NUTRIENT CONCENTRATIONS WITH OBSERVED IN-STREAM CONCENTRATIONS FOR THE GABINO SUB-BASIN (ALTERNATIVE B-4) .....	254
TABLE 5-65: PREDICTED AVERAGE ANNUAL TRACE METAL LOADS FOR THE GABINO SUB-BASIN (LBS).....	255
TABLE 5-66: PREDICTED AVERAGE ANNUAL TRACE METAL CONCENTRATIONS FOR THE GABINO SUB-BASIN (µG/L) .....	255
TABLE 5-67: COMPARISON OF PREDICTED TRACE METALS CONCENTRATIONS WITH WATER QUALITY CRITERIA AND OBSERVED IN-STREAM CONCENTRATIONS FOR THE GABINO SUB-BASIN (ALTERNATIVE B-4).....	256
TABLE 5-68: BLIND SUB-BASIN AVERAGE ANNUAL WATER BALANCE (ALTERNATIVE B-4) (INCHES (ACRE-FT)).....	264

TABLE 5-69: TALEGA SUB-BASIN AVERAGE ANNUAL WATER BALANCE (ALTERNATIVE B-4) (INCHES (ACRE-FT))..	264
TABLE 5-70: BLIND SUB-BASIN AVERAGE ANNUAL WATER BALANCE (ALTERNATIVE B-9) (INCHES (ACRE-FT)).....	265
TABLE 5-71: TALEGA SUB-BASIN AVERAGE ANNUAL WATER BALANCE (ALTERNATIVE B-9) (INCHES (ACRE-FT))..	265
TABLE 5-72: PREDICTED AVERAGE ANNUAL TSS LOADS AND CONCENTRATIONS FOR THE BLIND AND TALEGA SUB-BASINS (ALTERNATIVE B-4) .....	266
TABLE 5-73: COMPARISON OF PREDICTED TSS CONCENTRATION WITH WATER QUALITY OBJECTIVES AND OBSERVED IN-STREAM CONCENTRATIONS FOR THE BLIND SUB-BASIN (ALTERNATIVE B-4) .....	267
TABLE 5-74: PREDICTED AVERAGE ANNUAL NUTRIENT LOADS FOR THE BLIND AND TALEGA SUB-BASINS (ALTERNATIVE B-4) (LBS) .....	268
TABLE 5-75: PREDICTED AVERAGE ANNUAL NUTRIENT CONCENTRATIONS FOR THE BLIND AND TALEGA SUB-BASINS (ALTERNATIVE B-4) (MG/L) .....	268
TABLE 5-76: COMPARISON OF PREDICTED NUTRIENT CONCENTRATIONS WITH OBSERVED IN-STREAM CONCENTRATIONS FOR THE BLIND SUB-BASIN (ALTERNATIVE B-4) .....	269
TABLE 5-77: PREDICTED AVERAGE ANNUAL TRACE METAL LOADS FOR THE BLIND AND TALEGA SUB-BASINS (ALTERNATIVE B-4) (LBS) .....	271
TABLE 5-78: PREDICTED AVERAGE ANNUAL TRACE METAL CONCENTRATIONS FOR THE BLIND AND TALEGA SUB-BASINS (ALTERNATIVE B-4) (µG/L) .....	272
TABLE 5-79: COMPARISON OF PREDICTED TRACE METALS CONCENTRATIONS WITH WATER QUALITY CRITERIA AND OBSERVED IN-STREAM CONCENTRATIONS FOR THE BLIND SUB-BASIN (ALTERNATIVE B-4) .....	273
TABLE 5-80: PREDICTED AVERAGE ANNUAL TSS LOADS AND CONCENTRATIONS FOR THE BLIND AND TALEGA SUB-BASINS (ALTERNATIVE B-9) .....	274
TABLE 5-81: COMPARISON OF PREDICTED TSS CONCENTRATION WITH WATER QUALITY OBJECTIVES AND OBSERVED IN-STREAM CONCENTRATIONS FOR THE BLIND SUB-BASIN (ALTERNATIVE B-4) .....	274
TABLE 5-82: PREDICTED AVERAGE ANNUAL NUTRIENT LOADS FOR THE BLIND AND TALEGA SUB-BASINS (ALTERNATIVE B-9) (LBS) .....	275
TABLE 5-83: PREDICTED AVERAGE ANNUAL NUTRIENT CONCENTRATIONS FOR THE BLIND AND TALEGA SUB-BASINS (ALTERNATIVE B-9) (MG/L) .....	276
TABLE 5-84: COMPARISON OF PREDICTED NUTRIENT CONCENTRATIONS WITH OBSERVED IN-STREAM CONCENTRATIONS FOR THE BLIND SUB-BASIN (ALTERNATIVE B-9) .....	276
TABLE 5-85: PREDICTED AVERAGE ANNUAL TRACE METAL LOADS FOR THE BLIND AND TALEGA SUB-BASINS (ALTERNATIVE B-9) (LBS) .....	278
TABLE 5-86: PREDICTED AVERAGE ANNUAL TRACE METAL CONCENTRATIONS FOR THE BLIND AND TALEGA SUB-BASINS (ALTERNATIVE B-9) (µG/L) .....	279
TABLE 5-87: COMPARISON OF PREDICTED TRACE METALS CONCENTRATIONS WITH WATER QUALITY CRITERIA AND OBSERVED IN-STREAM CONCENTRATIONS FOR THE BLIND SUB-BASIN (ALTERNATIVE B-9) .....	280
TABLE 5-88: VERDUGO SUB-BASIN AVERAGE ANNUAL WATER BALANCE (ALTERNATIVE B-9) (INCHES (ACRE-FT)) .....	287
TABLE 5-89: PREDICTED AVERAGE ANNUAL TSS LOADS AND CONCENTRATIONS FOR THE VERDUGO SUB-BASIN (ALTERNATIVE B-9) .....	288
TABLE 5-90: COMPARISON OF PREDICTED TSS CONCENTRATION WITH WATER QUALITY OBJECTIVES AND OBSERVED IN-STREAM CONCENTRATIONS FOR THE VERDUGO SUB-BASIN (ALTERNATIVE B-9) .....	288
TABLE 5-91: PREDICTED AVERAGE ANNUAL NUTRIENT LOADS FOR THE VERDUGO SUB-BASIN (ALTERNATIVE B-9) (LBS) .....	289
TABLE 5-92: PREDICTED AVERAGE ANNUAL NUTRIENT CONCENTRATIONS FOR THE VERDUGO SUB-BASIN (ALTERNATIVE B-9) (MG/L) .....	289
TABLE 5-93: COMPARISON OF PREDICTED NUTRIENT CONCENTRATIONS WITH OBSERVED IN-STREAM CONCENTRATIONS FOR THE VERDUGO SUB-BASIN (ALTERNATIVE B-9) .....	290
TABLE 5-94: PREDICTED AVERAGE ANNUAL TRACE METAL LOADS FOR THE VERDUGO SUB-BASIN (ALTERNATIVE B-9)(LBS).....	291
TABLE 5-95: PREDICTED AVERAGE ANNUAL TRACE METAL CONCENTRATIONS FOR THE VERDUGO SUB-BASIN (ALTERNATIVE B-9)(µG/L) .....	291

TABLE 5-96: COMPARISON OF PREDICTED TRACE METALS CONCENTRATIONS WITH WATER QUALITY CRITERIA AND OBSERVED IN-STREAM CONCENTRATIONS FOR THE GABINO SUB-BASIN (ALTERNATIVE B-4).....	292
TABLE 5-97: PROJECTED RUNOFF WATER QUALITY FOR MIXED RESIDENTIAL LAND USES IN PLANNING AREA 1...	297
TABLE 6-1: CRITERIA FOR REVIEW AND EVALUATION OF MONITORING AND INSPECTION DATA AND POTENTIAL ACTIONS AND CORRECTIVE MEASURES.....	302
TABLE 8-1: COMPARISON OF ESTIMATED AVERAGE ANNUAL STORMWATER VOLUMES AT THE LA NOVIA GAUGING STATION AND THE ESTIMATED WITH-PROJECT CUMULATIVE INCREASE IN FLOWS BELOW RMV .....	320
TABLE 8-2: AVERAGE STORMWATER POLLUTANT CONCENTRATIONS FROM OCPFRD MONITORING AT THE LA NOVIA STATION USED TO ESTIMATE AVERAGE ANNUAL POLLUTANT LOADS.....	321
TABLE 8-3: AVERAGE ANNUAL STORMWATER LOADS AND CONCENTRATIONS AT THE LA NOVIA GAUGING STATION AND CUMULATIVE INCREASE IN LOADS AND CONCENTRATIONS FROM PROJECT BASED ON MODELING .....	321
TABLE 8-4: COMPARISON OF ESTIMATED AVERAGE TRACE METAL CONCENTRATIONS BELOW RMV AND AT LA NOVIA WITH THE CTR CRITERIA. ....	322
TABLE 8-5: AVERAGE ANNUAL STORMWATER RUNOFF VOLUMES AT USGS GAUGING STATIONS IN THE SAN MATEO WATERSHED. ....	323
TABLE 8-6: ESTIMATED PROJECT EFFECTS ON AVERAGE ANNUAL STORMWATER RUNOFF VOLUMES.....	324
TABLE 8-7: ESTIMATED CHANGES IN POLLUTANT LOADS AND CONCENTRATIONS AT SW-8.....	325

## **List of Figures**

*All figures are provided at the end of this document*

- Figure 1-1 Southern NCCP/HCP and SAMP/MSAA Planning Areas  
Figure 1-2 Location Map  
Figure 1-3 Alternative B4 Planning Area Location Map  
Figure 1-4 Alternative B9 Planning Area Location Map  
Figure 1-5 Rainfall Wet and Dry Cycles  
Figure 1-6 Geomorphic Terrains Map  
Figure 1-7 Stream Monitoring Locations
- Figure 3-1 Water Balance Conceptual Model  
Figure 3-2 Example Water Balance  
Figure 3-3 Flow Histograms for Pre- and Post- Development  
Figure 3-4 Example Flow Duration Curve for Cañada Gobernadora Catchment 3  
Figure 3-5 Schematic Illustration of Facilities in the Combined Control System  
Figure 3-6 Combined Flow and Water Quality Control System - Plan  
Figure 3-7 Combined Flow and Water Quality Control System – Profile  
Figure 3-8 Schematic Illustration of an Outlet Structure
- Figure 4-1 Planning Areas within the Cañada Chiquita Sub-basin  
Figure 4-2 Pre- and Post-Development Land Uses in the Cañada Chiquita Sub-basin  
Figure 4-3 Planning Areas within the Cañada Gobernadora Sub-basin  
Figure 4-4 Pre- and Post-Development Land Uses in the Cañada Gobernadora Sub-basin  
Figure 4-5 Planning Areas within the Central San Juan & Trampas Sub-basin  
Figure 4-6 Pre- and Post-Development Land Uses in Central San Juan & Trampas Sub-basin  
Figure 4-7 Planning Areas within the Cristianitos Sub-basin  
Figure 4-8 Pre- and Post-Development Land Uses in the Cristianitos Sub-basin  
Figure 4-9 Planning Areas within the Gabino Sub-basin  
Figure 4-10 Pre- and Post-Development Land Uses in the Gabino Sub-basin  
Figure 4-11 Planning Areas within the Talega & Blind Sub-basins  
Figure 4-12 Pre- and Post-Development Land Uses in the Talega & Blind Sub-basins  
Figure 4-13 Planning Areas within the Verdugo Sub-basin  
Figure 4-14 Pre- and Post-Development Land Uses in the Verdugo Sub-basin  
Figure 4-15 Sub-basins Affected by Planning Areas 1, 8A, and 9
- Figure 5-1 Flow Duration Curve for Cañada Chiquita Catchments 13  
Figure 5-2 Comparison of Average Monthly Precipitation for Cañada Chiquita  
Figure 5-3 Water Balance Results for the Chiquita Sub-basin  
Figure 5-4 Predicted Average Annual TSS Loads and Concentrations for Cañada Chiquita  
Figure 5-5 Predicted Average Annual Nitrate-N Loads and Concentrations for Cañada Chiquita  
Figure 5-6 Predicted Average Annual TKN Loads and Concentrations for Cañada Chiquita  
Figure 5-7 Predicted Average Annual Total Phosphorous Loads and Concentrations for Cañada Chiquita

- Figure 5-8 Predicted Average Annual Total Aluminum Loads and Concentrations for Cañada Chiquita
- Figure 5-9 Predicted Average Annual Dissolved Cadmium Loads and Concentrations for Cañada Chiquita
- Figure 5-10 Predicted Average Annual Dissolved Copper Loads and Concentrations for Cañada Chiquita
- Figure 5-11 Predicted Average Annual Dissolved Lead Loads and Concentrations for Cañada Chiquita
- Figure 5-12 Predicted Average Annual Dissolved Zinc Loads and Concentrations for Cañada Chiquita
- Figure 5-13 Flow Duration Curve for Cañada Gobernadora Catchment 3
- Figure 5-14 Comparison of Average Monthly Precipitation for Cañada Gobernadora
- Figure 5-15 Water Balance Results for the Cañada Gobernadora Sub-basin
- Figure 5-16 Predicted Average Annual TSS Loads and Concentrations for Cañada Gobernadora
- Figure 5-17 Predicted Average Annual Nitrate-N Loads and Concentrations for Cañada Gobernadora
- Figure 5-18 Predicted Average Annual TKN Loads and Concentrations for Cañada Gobernadora
- Figure 5-19 Predicted Average Annual Total Phosphorous Loads and Concentrations for Cañada Gobernadora
- Figure 5-20 Predicted Average Annual Total Aluminum Loads and Concentrations for Cañada Gobernadora
- Figure 5-21 Predicted Average Annual Dissolved Cadmium Loads and Concentrations for Cañada Gobernadora
- Figure 5-22 Predicted Average Annual Dissolved Copper Loads and Concentrations for Cañada Gobernadora
- Figure 5-23 Predicted Average Annual Dissolved Lead Loads and Concentrations for Cañada Gobernadora
- Figure 5-24 Predicted Average Annual Dissolved Zinc Loads and Concentrations for Cañada Gobernadora
- Figure 5-25 Flow Duration Curve for Central San Juan & Trampas- Catchment 25a, 25b, and PA5-4
- Figure 5-26 Runoff Routing in PA 7 and PA 8 for the B-4 Alternative
- Figure 5-27 Flow Duration Curve for Cristianitos- Catchments PA7-9
- Figure 5-28 Water Balance Results for Cristianitos Sub-basin
- Figure 5-29 Flow Duration Curve for Talega- Catchment PA8-6
- Figure 5-30 Flow Duration Curve for Verdugo – Catchments 120, 121a, 121b, 121c, 122, PA4-4, PA4-5
- Figure 7-1 Alternative Planning Area Maps
- Figure 8-1 Cumulative Increases in Annual Storm Runoff Volumes in the San Juan Watershed
- Figure 8-2 Cumulative Increase in Annual Pollutant Loads in the San Juan Watershed
- Figure 8-3 Cumulative Increases in Annual Storm Runoff Volumes in the San Mateo Watershed
- Figure 8-4 Cumulative Increases in Annual Pollutant Loads in the San Mateo Watershed

## **Appendix A**

- Figure A-1 Hydrologic Cycle
- Figure A-2 Conceptualization of Sub-basin Disaggregation
- Figure A-3 Location of Selected Rain Gauges in Orange County
- Figure A-4 Elevation Profiles Between Selected Rain Gauges
- Figure A-5 Rainfall Correlations for Monthly, Annual, and Storm Event Accumulations of Hourly Precipitation Data
- Figure A-6 Rainfall Wet and Dry Cycles
- Figure A-7 Planning Area Location Map
- Figure A-8 Cañada Chiquita Sub-basin Pre- and Post-Development Land Use
- Figure A-9 Cañada Chiquita Sub-basin Soil Texture Distribution
- Figure A-10 Cañada Gobernadora Sub-basin Pre- and Post-Development Land Use
- Figure A-11 Cañada Gobernadora Sub-basin Soil Texture Distribution
- Figure A-12 Comparison of Measured and Simulated Hydrographs for Upper Gobernadora
- Figure A-13 Central San Juan & Trampas Sub-basin Pre- and Post-Development Land Use
- Figure A-14 Central San Juan & Trampas Sub-basin Soil Texture Distribution
- Figure A-15 Cristianitos Sub-basin Pre- and Post-Development Land Use
- Figure A-16 Cristianitos Sub-basin Soil Texture Distribution
- Figure A-17 Gabino Sub-basin Pre- and Post-Development Land Use
- Figure A-18 Gabino Sub-basin Soil Texture Distribution
- Figure A-19 Blind & Talega Sub-basins Pre- and Post-Development Land Use
- Figure A-20 Blind & Talega Sub-basins Soil Texture Distribution
- Figure A-21 Verdugo Sub-basin Pre- and Post-Development Land Use
- Figure A-22 Verdugo Sub-basin Soil Texture Distribution

## **Appendix B**

- Figure B-1 An Example Illustration of TSS Loads and Concentrations for Cañada Chiquita



## List of Abbreviations

ASCE	American Society of Civil Engineers
BMP	Best Management Practice
Bti	Bacillus thuringiensis israeliensis (natural microbial pesticide for mosquitoes)
CDFG	California Department of Fish and Game
CESA	California Endangered Species Act
CEQA	California Environmental Quality Act
cfs	cubic feet per second
CIMIS	California Irrigation Management Information System
CWA	Clean Water Act
CTR	California Toxics Rule
DAMP	Drainage Area Management Plan
EIR	Environmental Impact Report
EMC	Event Mean Concentration
ET	Evapotranspiration
FESA	Federal Endangered Species Act
GPA/ZC	General Plan Amendment/Zone Change
HCP	Habitat Conservation Plan
JURMP	Jurisdictional Urban Runoff Management Plan
MS4	Municipal Separate Storm Sewer System
msl	mean sea level
NCCP/HCP	Natural Communities Conservation Plan/Habitat Conservation Plan
NEPA	National Environmental Policy Act
NPDES	National Pollutant Discharge Elimination System
NPS	Nonpoint Source
NTS	Natural Treatment System
OCFCD	Orange County Flood Control District
OCHCA	Orange County Health Care Agency
OCRDM	Orange County Resources and Development Management Department
OCVCD	Orange County Vector Control District
OCWD	Orange County Water District
PA	Planning Area
PCB	Polychlorinated Biphenyl
PEL	Probable Effects Limit
ppb	parts per billion
RMV	Rancho Mission Viejo
SAMP/MSAA	Special Area Management Plan/Master Streambed Alteration Agreement
SCS	Soil Conservation Service
SDRWQCB	San Diego Regional Water Quality Control Board
SWPPP	Storm Water Pollution Prevention Plan
SWRCB	California State Water Resources Control Board
TMDL	Total Maximum Daily Load
TKN	Total Kjeldahl Nitrogen
TP	Total Phosphorus

TSS	Total Suspended Solids
USCOE	United States Army Corps of Engineers
USEPA	United States Environmental Protection Agency
USFWS	United States Fish and Wildlife Service
WQMP	Water Quality Management Plan

# **1 INTRODUCTION AND WATERSHED ENVIRONMENTAL SETTING**

## **1.1 ROLE OF THE WATER QUALITY MANAGEMENT PLAN IN THE COORDINATED PLANNING PROCESS**

This Conceptual Water Quality Management Plan (WQMP) was developed by Rancho Mission Viejo (RMV) consistent with the County of Orange Drainage Area Management Plan (DAMP) Local Implementation Plan and in support of planning efforts for RMV lands in the San Juan Creek and western San Mateo Creek watersheds involved in the coordinated planning process.

Water quality management, including planning for the hydrologic and geomorphologic processes is central to assuring the long-term viability of important habitat systems and species dependent upon those systems. The San Diego Regional Water Quality Control Board (SD RWQCB) has established a program for implementing federal stormwater/water quality management requirements, including the implementation of the Jurisdictional Urban Runoff Management Plan (JURMP). In February 2002, the SDRWQCB issued 3<sup>rd</sup> Term NPDES Permits requiring the implementation of the Drainage Area Management Plan (DAMP) which includes a program for managing the effects of New Development/Significant Redevelopment. In response, the County of Orange prepared a County Local Implementation Plan (LIP) (2003 DAMP Appendix A). The County of Orange LIP contains provisions for identifying “pollutants of concern” and “hydrologic conditions of concern” that are applicable to species protection and management and to hydrologic and geomorphologic processes that need to be addressed. The LIP also specifically addresses the CEQA requirements associated with preparing a project specific Water Quality Management Plan. The County LIP and the DAMP’s Model WQMP provided the overall context for the preparation of this document.

This Conceptual WQMP is the first of four levels of WQMP preparation. These levels include the Conceptual WQMP, the Master Area Plan WQMP, the Sub-Area Plan WQMP, and the final project-specific WQMP. The Conceptual WQMP sets the framework for the future levels of WQMP preparation.

Prior to the approval of a Master Area Plan for each Planning Area, a Master Area Plan WQMP will be prepared consistent with the terms and content of this Conceptual WQMP. The Master Area Plan WQMP will provide more specific information and detail concerning how the provisions of the Conceptual WQMP will be implemented within the area covered by the individual Master Area Plan. At a minimum, each Master Area Plan will provide supplemental and refined information concerning: (1) how site design, source control, and treatment control BMPs will be implemented at the Master Area Plan level for the area in question; (2) potential facility sizing and location within the subject Area Plan area; and (3) monitoring and operation and maintenance of stormwater BMPs within the relevant Area Plan area.

Prior to the approval of a Sub-Area Plan for any portion of the project area that is the subject of an approved Master Area Plan, a Sub-Area Plan WQMP will be prepared that is consistent with

the terms and content of this Conceptual WQMP as well as the relevant Master Area Plan WQMP. The Sub-Area Plan WQMP will provide supplemental and refined information concerning: (1) how site design, source control, and treatment control BMPs will be implemented at the Sub-Area Plan level for the area in question; (2) sizing, location, and design features for the stormwater BMP facilities to be developed within the subject Sub-Area Plan area; and (3) monitoring and operation and maintenance of stormwater BMPs within the relevant Sub-Area Plan area.

A final WQMP that specifically identifies the BMPs to be used on site will be submitted for review prior to the recordation of any final subdivision map (except those maps for financing or conveyance purposes only) or the issuance of any grading or building permit (whichever comes first). The project-specific WQMP will identify, at a minimum: (1) site design BMPs (as appropriate); (2) the routine structural and non-structural BMPs; (3) treatment control BMPs; and (4) the mechanism(s) by which long-term operation and maintenance of all structural BMPs will be provided.

The WQMP is also intended to support the water quality, geomorphic, and habitat goals of the following planning processes:

- Southern NCCP/HCP. The Southern Natural Community Conservation Plan/Habitat Conservation Plan (Southern NCCP/HCP) is being prepared by the County of Orange in cooperation with the California Department of Fish and Game (CDFG) and the U.S. Fish and Wildlife Service (USFWS) in accordance with the provisions of the state natural Community Conservation Planning Act of 1991 (NCCP Act), the California Endangered Species Act (CESA), and the federal Endangered Species Act (FESA). The Southern Orange County Subregion is part of the five-county NCCP Study Area established by the state as the Pilot Study Area under the NCCP Program.
- San Juan/San Mateo Watersheds SAMP/MSAA. A Special Area Management Plan (SAMP) and Master Streambed Alteration Agreement (MSAA) is being prepared jointly by the U.S. Army Corps of Engineers (USACE) and CDFG and covers generally those portions of the San Juan Creek and San Mateo Creek watersheds located within the Southern NCCP/HCP Subregion. As in the case of the NCCP/HCP, the SAMP/MSAA is a voluntary process. The purpose of the SAMP/MSAA is to provide for the protection and long-term management of sensitive aquatic resources (biological and hydrological) on a landscape level. The SAMP/MSAA is also designed to enable economic uses to be permitted within the SAMP study area portions of the San Juan Creek watershed consistent with the requirements of federal and state laws (particularly the federal Clean Water Act (CWA), including Sections 401 and 404) and California Fish & Game Code Sections 1600 et seq.
- County of Orange/Rancho Mission Viejo GPA/ZC. Rancho Mission Viejo has submitted an application to the County of Orange which includes a request for a General Plan

Amendment and Zone Change (GPA/ZC). The GPA/ZC application would provide for new development and preservation of natural habitat and other open space within the remaining 22,815 acres of Rancho Mission Viejo's lands located in southern Orange County. The Rancho Mission Viejo lands included in the proposed GPA/ZC constitute a central focus of the Southern NCCP/HCP and SAMP/MSAA planning programs because these lands comprise 90 percent of the remaining privately owned lands in the Southern NCCP/HCP and SAMP/MSAA planning areas (Figure 1-1) and over 98 percent of the privately owned lands actively involved in the NCCP/HCP and SAMP/MSAA that are not already developed or approved for development.

Although there is every intent to complete all three planning processes (the NCCP/HCP, SAMP/MSAA and GPA/ZC), there is no way to ensure this result. Accordingly this Conceptual WQMP has employed and addressed applicable NCCP/HCP and SAMP/MSAA Guidelines and Principles at both the watershed and sub-basin scale. In this way, species, habitat, and hydrologic and geomorphic considerations identified through the planning processes have been fully integrated into the Conceptual WQMP.

Water quality management, including planning for the hydrologic and geomorphologic processes identified in Tenet 7 of the Southern NCCP Science Advisors Report, is central to assuring the long-term viability of important habitat systems and species dependent upon those systems. The State of California Nonpoint Source Plan emphasizes the need to address water quality planning at a large geographic scale (SWRCB, 2000). One of the policy directives set forth in the State NPS Plan is to:

*“Manage NPS pollution, where feasible, at the watershed level – including pristine areas and watersheds that contain water bodies on the Clean Water Act (CWA) 303(d) list – where local stewardship and site-specific MPs (Management Practices) can be implemented through comprehensive watershed protection or restoration plans.”*

The San Diego Regional Water Quality Control Board (SD RWQCB) has established a program for implementing federal stormwater/water quality management requirements, including the preparation of a Jurisdictional Urban Runoff Management Plan (JURMP) within a time frame that generally parallels the GPA/ZC, NCCP/HCP and SAMP/MSAA. In February 2002, the SDRWQCB published a Model Standard Urban Storm Water Mitigation Plan that can be addressed through the preparation of a JURMP. Subsequently, as part of its MS4/Drainage Area Management Program (DAMP), the County of Orange has prepared a Model Water Quality Management Plan adapted to Orange County conditions and intended to address SDRWQCB MS4 requirements. Both the SDRWQCB and the County of Orange model plans contain provisions for identifying “pollutants of concern” and “hydrologic conditions of concern” that are applicable to species protection and management and to hydrologic and geomorphologic processes that need to be addressed pursuant to the NCCP/HCP and SAMP/MSAA.

In addition, the SAMP/MSAA must address CWA water quality requirements. Accordingly, there is a need to assure the coordination of water quality management with the RMV Adaptive Management Program. Thus, water quality management planning must address and integrate: (1) the requirements and policies of the SDRWQCB, County of Orange DAMP/MS4, and the State of California NPS Plan; (2) the requirements of CWA Section 401 and the USACE 404(b)(1) water quality guidelines in conjunction with the SAMP/MSAA; and (3) species and habitat protection, management and enhancement/restoration considerations relating to “pollutants of concern” and “hydrologic conditions of concern” in the context of NCCP/SAMP planning, including, as applicable, Draft Planning Guidelines and Watershed and Sub-basin Planning Principles prepared by the NCCP/SAMP Working Group.

Water quality planning intended to coordinate applicable SDRWQCB policies, measures, and implementation programs with the RMV Open Space and associated Adaptive Management Plan. In this way, open space protection considerations will include the protection of important areas for sediment generation, planning to protect against detrimental turbidity in stormwater runoff, and recommendations for the location of Best Management Practices (BMPs) to address pollutants of concern and hydrologic conditions of concern potentially affecting the Sensitive Species. Emphasis should be placed on addressing: (i) pollutants that may affect individual species/habitats that are addressed in the draft NCCP/HCP Guidelines and SAMP/MSAA Watershed Principles; and (ii) important hydrologic/geomorphologic processes and conditions identified in the SAMP/MSAA Watershed Principles.

## **1.2 WATERSHED PLANNING**

Water quality planning embraces a wide array of planning considerations including: (a) the formulation of treatment systems and measures to address specific pollutants potentially impacting species (termed “pollutants of concern”); and (b) open space planning/development considerations and hydrology/sediment management programs for purposes of protecting hydrologic and geomorphic processes essential to maintaining both uplands and aquatic/riparian habitat systems (termed “hydrologic conditions of concern”).

The State NPS Plan emphasizes watershed planning and contains an implementation measure, Management Measure 3.1A – Watershed Protection, that emphasizes a watershed approach to water quality management and includes reference to CWA Section 402 (the section governing NPDES stormwater programs) as a primary statutory element of the Management Measure. The State NPS Plan also includes Management Measures 6B and C, which emphasize the use of natural treatment systems to address non-point source pollution.

### **1.2.1 SAMP**

Recognizing the need for more comprehensive planning in 1998, a resolution by the United States House of Representatives’ Committee on Public Works authorized the Corps of Engineers, Los Angeles District Regulatory Branch (Corps) to initiate a Special Area Management Plan (SAMP) within the San Juan Creek and San Mateo Creek watersheds. A

SAMP is a management tool that will achieve a balance between aquatic resource protection and economic development and will promote the resolution of conflicts between aquatic resource conservation and those development and infrastructure projects affecting aquatic resources in a coordinated process with federal, state and local agencies and local stakeholders. Accordingly, the SAMP/MSAA process is being coordinated with the NCCP/HCP environmental review program for the Southern Orange County NCCP Subregion.

The broad goals of the SAMP are to allow for comprehensive management of aquatic resources and to increase regulatory predictability for development and infrastructure projects that would impact aquatic resources.

### ***Watershed and Sub-Basin Planning Principles***

The USACE, Los Angeles District, and the CDFG previously prepared a set of general watershed tenets (planning framework) that was presented at the public workshops on December 13, 2001 and May 15, 2002. The Statewide NCCP Guidelines were adopted in 1993 by the CDFG. The NCCP/SAMP Working Group concluded that the preparation of a set of more geographically-specific planning principles would help provide focus for the SAMP/MSAA planning effort and provide valuable guidance during preparation of the Southern NCCP/HCP.

The draft Watershed and Sub-basin Planning Principles for the San Juan/Western San Mateo watersheds (“Watershed Planning Principles”) provide a link between the broader SAMP/MSAA Tenets for protecting and conserving aquatic and riparian resources and the known, key physical and biological resources and processes that will be addressed in formulating the reserve program for the Southern SAMP/MSAA and NCCP/HCP. The principles refine the planning framework tenets and identify key physical and biological processes and resources at both the watershed and sub-basin level. These tenets and principles are to be the focus of the aquatic resources reserve and management program. Application of the planning recommendations is consistent with the NCCP Science Advisors recognition that the NCCP Reserve Design Principles are not absolutes and “that it may be impractical or unrealistic to expect that every design principle will be completely fulfilled throughout the subregion” (NCCP Science Advisors, 1997).

The Watershed Planning Principles represent a synthesis of the following sources:

- Southern SAMP/MSAA tenets.
- USACE Watershed Delineation and Functional Assessment reports.
- Baseline Geomorphic and Hydrologic Conditions Report (Baseline Conditions Report), and associated technical reports, prepared by Balance Hydrologics, PCR Services Corporation, and Philip Williams & Associates, Ltd. for RMV.

- Reserve Design Principles (1997) prepared by the Science Advisors for the Southern NCCP/HCP.
- Southern Subregion databases.

The Watershed Planning Principles provide a key link between the SAMP/MSAA and the NCCP/HCP. Recognizing the significance of watershed physical processes, the Science Advisors added a new tenet of reserve design (Tenet 7 – “Maintain Ecosystem Processes and Structures”). Tenet 7 was directed in significant part toward protecting to the maximum extent possible the hydrology regimes of riparian systems. The fundamental hydrologic and geomorphic processes of the overall watersheds and of the sub-basins not only shape and alter the creek systems in the planning area over time but also play a significant role in influencing upland habitat systems. The hydrologic “sub-basin” has been selected as the geographic planning unit because it is important to focus on the distinct biologic, geomorphic and hydrologic characteristics of each sub-basin while formulating overall reserve programs for the NCCP/HCP and SAMP/MSAA. For each sub-basin, the important hydrologic and geomorphic processes and aquatic/riparian resources are identified and reviewed under the heading of “planning considerations.” This review is then followed by protection and enhancement/restoration recommendations under the heading of “planning recommendations.” Thus, if for some reason either the SAMP or NCCP (or even both) were not finalized, the use of the Watershed Planning Principles in the WQMP assures that key species, habitat, hydrologic and geomorphic water quality related considerations have been addressed by the Conceptual WQMP.

### **1.2.2 NCCP**

The NCCP program is a cooperative effort to protect habitats and species. The program, which began in 1991 under the State's Natural Community Conservation Planning Act, is broader in its orientation and objectives than the California and Federal Endangered Species Acts. These laws are designed to identify and protect individual species that have already declined in number significantly. The primary objective of the NCCP program is to conserve natural communities at the ecosystem scale while accommodating compatible land uses. The program seeks to anticipate and prevent the controversies and gridlock caused by species' listings by focusing on the long-term stability of wildlife and plant communities and including key interests in the process.

The focus of the initial effort was the coastal sage scrub habitat of Southern California, home to the California gnatcatcher and approximately 100 other potentially threatened or endangered species. This much-fragmented habitat is scattered over more than 6,000 square miles and encompasses large parts of three counties - Orange, San Diego, and Riverside - and smaller portions of two others - Los Angeles and San Bernardino. Fifty-nine local government jurisdictions, scores of landowners from across these counties, federal wildlife authorities, and the environmental community are actively participating in the program. As reviewed in the prior discussion, the NCCP/HCP and SAMP/MSAA have a goal of preparing a Habitat Reserve and



associated long-term management program that addresses the objectives of both the NCCP/HCP and the SAMP/MSAA.

### **1.3 THE ROLE OF THE WATER QUALITY MANAGEMENT PLAN IN SUPPORTING THE GPA/ZC**

This Conceptual WQMP assesses potential water quality, water balance, and hydromodification impacts associated with the “B” development alternatives selected for review under the GPA/ZC, NCCP/HCP, and SAMP/MSAA; and recommends control measures to address those potential impacts. The Conceptual WQMP was initially prepared to address the Proposed GPA/ZC Project “The Ranch Plan” (also known as Alternative B-4) in support of the GPA/ZC as well as the NCCP/HCP and SAMP/MSAA. With the formulation of the B-9 alternative by the NCCP/SAMP Working Group as an alternative designed to meet the NCCP Guidelines and Watershed Planning Principles, the Conceptual WQMP has been expanded to include measures and analyses addressing the B-9 alternative. With regard to the other “B and County” alternatives under consideration in conjunction with the coordinated planning process, this Conceptual WQMP would apply directly to those alternatives or portions of alternatives where proposed development planning areas coincide (e.g. the B-8 alternative) with corresponding development planning areas under the B-4 and B-9 alternatives. However, where development planning areas do not match those of the B-4 or B-9 alternatives, the measures and analyses are applied qualitatively to such alternatives or to particular development planning areas that differ from the B-4 and/or B-9 alternative.

### **1.4 GEOGRAPHIC AREA ADDRESSED BY THE WATER QUALITY MANAGEMENT PLAN**

The Conceptual WQMP focuses on approximately 22,815-acres that constitute the remaining undeveloped portions of the Rancho Mission Viejo located within unincorporated Orange County (Figure 1-2). The planned community of Ladera Ranch and the cities of Mission Viejo, San Juan Capistrano and San Clemente surround the Project area on the west. The City of Rancho Santa Margarita bounds the northern edge of the Project area; the southern edge is bounded by Marine Corps Base Camp Pendleton in San Diego County. Caspers Wilderness Park and the Cleveland National Forest bound the property on its eastern edge.

The B-4 and B-9 Alternatives include development within the following sub-basins in the San Juan Creek Watershed: Narrow Canyon and Lower San Juan Creek, Cañada Chiquita, Cañada Gobernadora, Central San Juan & Trampas Canyon, and Verdugo Canyon. The Conceptual WQMP distinguishes Narrow Canyon and Lower San Juan Creek from the Cañada Chiquita Sub-basin, which are combined in the NCCP/HCP and SAMP/MSAA planning documents. The B-4 Alternative includes development within the following sub-basins in the San Mateo Watershed: Cristianitos, Lower Cristianitos, Gabino, Blind Canyon, Talega, and La Paz. The B-9 Alternative proposes development in Talega and Blind in the San Mateo Watershed.

As proposed by Rancho Mission Viejo, the B-4 Alternative includes 22,815 acres general planned and zoned for residential development of up to 14,000 dwelling units and other uses on 7,694 acres in nine planning areas (Figure 1-3 and Table 1-1). The B-4 alternative proposes 15,121 acres of open space which includes a proposed 1,034-acre regional park. Other uses include 91 acres of urban activity center uses, 240 acres of business park uses, 50 acres of neighborhood retail uses, and up to five golf courses. Ranching activities would also be retained within a portion of the proposed non-reserve open space area. Infrastructure would be constructed to support all of these uses, including road improvements, utility improvements and schools.

The B-9 alternative includes 22,815 acres general planned and zoned for residential development of up to 13,600 dwelling units and other uses, e.g., urban activity center uses, business park uses, and neighborhood retail uses, on 6,582 acres in six planning areas (Figure 1-4 and Table 1-1). The B9 alternative proposes 16,233 acres of open space. Ranching activities would also be retained within a portion of the proposed open space area. Infrastructure would be constructed to support all of these uses, including road improvements, utility improvements and schools.

## **1.5 ANALYTICAL APPROACH EMPLOYED IN FORMULATING THE CONCEPTUAL WQMP**

The Conceptual WQMP has been developed using a watershed-based approach that addresses pollutants of concern and hydrologic conditions of concern that can affect aquatic and upland habitat and natural resources, including species associated with these habitats and natural communities. The Conceptual WQMP includes site design, source control, and treatment control Best Management Practices (BMPs), selected consistent with Orange County's LIP and which address the applicable Draft NCCP/HCP Planning Guidelines and the Draft Watershed and Sub-basin Planning Principles developed by the NCCP/SAMP Working Group.

The Watershed and Sub-Basin Planning Principles are founded on the terrain analysis of the geology, soils, topography, and other environmental conditions in the watersheds and serve to integrate review and planning criteria for the SAMP/MSAA with review and planning criteria for the NCCP/HCP (particularly with the NCCP Science Advisors Reserve Design Tenet 7). In turn, these SAMP/MSAA Principles are linked with the analyses of pollutants of concern and hydrologic conditions of concern as articulated in the County of Orange LIP's Local WQMP.

**Table 1-1: B-4 and B-9 Alternatives Proposed Land Use Areas by Sub-basin**

Alternative	Land Uses	Land Use Area within Sub-basin (acres)										
		Narrow/ Lower San Juan	Chiquita	Gobernadora	Central San Juan/Trampas	Verdugo Canyon	Cristianitos	Gabino	La Paz Canyon	Blind/ Talega Canyon	Lower Cristianitos	Total
B4	Casitas	0	0	0	0	0	0	20	0	0	0	<b>20</b>
	Estate	75	0	140	230	108	2	197	7	0	0	<b>759</b>
	Golf Course	0	113	0	12	1	195	263	0	136	0	<b>719</b>
	Golf Residential	0	211	25	0	0	0	5	0	66	0	<b>307</b>
	Golf Resort	0	0	0	0	0	0	0	0	20	0	<b>20</b>
	Proposed Development	524	339	933	2475	0	527	269	0	661	140	<b>5869</b>
	Open Space	1429	2068	1077	2055	1738	551	3606	1358	1091	148	<b>15121</b>
	<b>TOTAL</b>	<b>2028</b>	<b>2731</b>	<b>2175</b>	<b>4772</b>	<b>1847</b>	<b>1275</b>	<b>4360</b>	<b>1365</b>	<b>1974</b>	<b>288</b>	<b>22815</b>
B9	Golf Course	0	0	0	0	0	0	0	0	225	0	<b>225</b>
	Golf Resort	0	0	0	0	0	0	0	0	25	0	<b>25</b>
	Proposed Development	599	309	1037	3213	479	1	16	0	644	33	<b>6332</b>
	Open Space	1429	2423	1138	1559	1368	1274	4344	1364	1080	254	<b>16233</b>
	<b>TOTAL</b>	<b>2028</b>	<b>2732</b>	<b>2175</b>	<b>4772</b>	<b>1847</b>	<b>1275</b>	<b>4360</b>	<b>1365</b>	<b>1974</b>	<b>287</b>	<b>22815</b>

As reviewed in the above-referenced NCCP/HCP AND SAMP/MCAA planning guidelines and planning principles, watershed scale protection, enhancement, and management of natural resources require an understanding of the landscape-scale processes that govern the integrity and long-term viability of aquatic and other natural resources. By taking a landscape perspective in assessment and planning, cumulative impacts and appropriate mitigation measures can be better addressed. Furthermore, the constraints associated with natural resources and processes can be integrated early in the development process, thereby minimizing impacts. Accordingly, the goal of the management alternatives presented in the Conceptual WQMP is to provide for protection of major wetlands and riparian areas, maintain aquatic resource functions, and address sensitive species in terms of hydrology, geomorphology, and water quality.

Potential changes in pollutants of concern and hydrologic conditions of concern in nine sub-basins – Cañada Chiquita, Cañada Gobernadora, Central San Juan north of San Juan Creek, Trampas Canyon and Central San Juan south of San Juan Creek, Cristianitos, Gabino, Blind, Talega, and Verdugo - are addressed based on runoff water quality and quantity modeling, literature information, and professional judgment. The level of significance of impacts is evaluated based on significance criteria that include predicted runoff quality and quantity for proposed versus existing water quality and quantity conditions, water quality standards, MS4 Permit requirements, and effects on NCCP/HCP “planning species”. Because the analyses and water quality management recommendations for these sub-basins involve areas with a wide diversity of terrains and proposed development types, the results of these sub-basin analyses have been used to predict the potential impacts and recommended management measures for the areas encompassed by the “B” and other Alternatives in the manner summarized in Section 1.3 above and discussed more specifically below.

## **1.6 CONCEPTUAL WQMP CONTENT AND ORGANIZATION**

The Conceptual WQMP introduction in this chapter provides general information on the environmental and regulatory settings affecting the preparation and regulatory review of the Conceptual WQMP. The remainder of the Conceptual WQMP is organized into eight chapters. Chapters 2 through 4 contain the preliminary project description, site description, BMP description, and operation and maintenance program as required by the County of Orange LIP (Table 1-2). Chapters 5 through 8 provide the CEQA analysis of impacts assuming implementation of the Conceptual WQMP. The scope of each chapter is as follows.

- Chapter 2 identifies the pollutants of concern and the hydrologic conditions of concern for the San Juan and San Mateo watersheds and lists the significance criteria and thresholds that are used in the assessment of the potential impacts of each alternative.
- Chapter 3 provides an overview of the approach used in selection of runoff control BMPs and the method used in modeling the effectiveness of the BMPs.

- Chapter 4 describes both general WQMP elements that apply to all of the proposed development areas (site design, source control BMPs, and BMP operation and maintenance) and sub-basin specific runoff control BMPs for the B-4 and B-9 Alternatives.
- Chapter 5 presents the impact analysis for the B-4 and B-9 Alternatives.
- Chapter 6 presents a plan for long term adaptive management of the proposed control system.
- Chapter 7 provides the impact analysis for the remaining “B” Alternatives (B-5, B-6, and B-8) and two County alternatives (B-10 and B-11).
- Chapter 8 presents a cumulative impact analysis for the B-4 and B-9 Alternatives.

**Table 1-2: LIP WQMP Template and Conceptual WQMP Elements**

<b>LIP WQMP Template Element</b>	<b>RMV Conceptual WQMP Element</b>
<b>1. Title Page with following:</b> <ul style="list-style-type: none"> <li>• “Water Quality Management Plan”</li> <li>• Project Name</li> <li>• Permit #, Tract #, CUP, SUP, or APN</li> <li>• Project Owner/Developer</li> <li>• Owner’s Name, address, and telephone #</li> <li>• Name of Consultant that prepared WQMP</li> <li>• WQMP Preparation Date</li> </ul>	1. Cover page includes all required elements, except the Permit #, Tract #, CUP, SUP, or APN, which will be included in future WQMP submittals.
<b>2. Owner’s Certification</b>	2. Will be included on future WQMP submittals.
<b>3. Table of Contents</b>	3. Included on pages i - xiii.
<b>4. Discretionary Permits and Water Quality Conditions</b> <ul style="list-style-type: none"> <li>• Include a Separator and Tab for Section I for ready reference.</li> <li>• Provide County of Orange Permit/Application and Tract/Parcel Map Number(s);</li> <li>• Provide Water Quality Condition Number, if applicable, requiring the preparation of a Water Quality Management Plan;</li> <li>• List WQMP condition(s) verbatim, if applicable;</li> <li>• Specify the Lot and Tract/Parcel Map number describing the subject property</li> </ul>	4. Will be included in future WQMP submittals.
<b>5. Project Description:</b>	
<ul style="list-style-type: none"> <li>• Include a Separator and Tab for Section II for ready reference.</li> </ul>	<ul style="list-style-type: none"> <li>• Will be included in future WQMP submittals.</li> </ul>
Describe the type of project, size and details of project, and associated uses, including the following:	

LIP WQMP Template Element	RMV Conceptual WQMP Element
<p>For All Projects:</p> <ul style="list-style-type: none"> <li>Identify the potential stormwater or urban runoff pollutants reasonably expected to be associated with the project;</li> <li>Type and location of parking (ex. Surface, garage, and/or carport) and portion of site on which parking is located;</li> <li>Describe landscaped areas;</li> <li>Percent of site covered by impermeable surfaces;</li> <li>Specify if a homeowners or property owners association will be formed, and if a master association will be involved in maintenance activities;</li> <li>Describe ownership of all portions of site (ex., open space/landscape lots/easements, which streets are to be public and private, etc.).</li> </ul>	<ul style="list-style-type: none"> <li>The potential runoff pollutants are identified in Section 2.3.</li> <li>A general project description is provided in Section 1.4</li> <li>Detailed project descriptions (parking, landscaped areas, percent of site covered with impervious surface, and site ownership) will be included in future WQMP submittals.</li> <li>The Stormwater BMP Operation and Maintenance Program is presented at a conceptual level in Section 4.1.4. Further detail will be included in future WQMP submittals.</li> </ul>
<p>For Commercial/Industrial Projects</p> <ul style="list-style-type: none"> <li>Type(s) of use(s) for each building or tenant space; Specify location(s) for each type of food preparation, cooking and/or eating areas;</li> <li>Specify location (and design, if below grade) of designated delivery areas and loading docks. Specify type(s) of materials expected to be delivered;</li> <li>Describe and depict location(s) of outdoor materials storage area(s) and type(s) of materials expected to be stored;</li> <li>Specify if there will be waste generation, car washing, auto repair (include number of service bays), and/or vehicle fueling (include number of fuel pumps).</li> </ul>	<ul style="list-style-type: none"> <li>A general project description is provided in Section 1.4</li> <li>Detail information on proposed commercial areas will be provided in future WQMP submittals.</li> </ul>
<p>For Residential Projects</p> <ul style="list-style-type: none"> <li>Provide the range of lot and home sizes, attached/detached, etc.;</li> <li>Describe pools, parks, open spaces, tot lots, etc., and any maintenance issues related to them.</li> </ul>	<ul style="list-style-type: none"> <li>A general project description is provided in Section 1.4</li> <li>Details on residential lots and home sizes, pools, parks, open spaces will be provided in future WQMP submittals.</li> </ul>
<p><b>6. Site Description</b></p>	
<ul style="list-style-type: none"> <li>Planning Area/Community Name: Provide exhibit of subject and surrounding Planning Areas in sufficient detail to allow project location to be plotted on a base map of the County;</li> </ul>	<ul style="list-style-type: none"> <li>Project location and Planning Areas are illustrated in Figures 1-2, 1-3, and 1-4.</li> <li>A more detailed exhibit will be provided in future WQMP submittals.</li> </ul>
<ul style="list-style-type: none"> <li>Provide site specifics such as general and specific location, site address, and size (acreage to the nearest 1/10 acre);</li> </ul>	<ul style="list-style-type: none"> <li>A general project description is provided in Section 1.4</li> <li>Site specifics will be provided in future WQMP submittals.</li> </ul>

<b>LIP WQMP Template Element</b>	<b>RMV Conceptual WQMP Element</b>
<ul style="list-style-type: none"> <li>Site characteristics: Include description of site drainage and how it ties with drainage of surrounding property (ex., The on-site drainage system connects to the drainage system in tract to the west, which drains to a detention/desilting basin located , and then to Creek, as specified in the Basin/Urban Runoff Management Plan). Reference the WQMP's Plot Plan showing drainage flow arrows and how drainage ties to drainage of surrounding property.</li> </ul>	<ul style="list-style-type: none"> <li>Site drainage is generally described in Chapter 4 by sub-basin. Each sub-basin section contains a description of the combined control system elements by sub-basin catchment (e.g., Section 4.2.3 describes the drainage, by land use type, within the Cañada Chiquita sub-basin).</li> <li>A detailed site assessment is contained in the Baseline Geomorphic and Hydrologic Conditions Report (PCR et al, 2002).</li> <li>Drainage details will be provided in future WQMP submittals.</li> </ul>
<ul style="list-style-type: none"> <li>Identify the zoning or land use designation;</li> </ul>	<ul style="list-style-type: none"> <li>Land uses designations for sub-basin are listed in the site assessment sections of Chapter 4 (e.g., Section 4.2.1 lists the land uses proposed for Cañada Chiquita in Table 4-5).</li> </ul>
<ul style="list-style-type: none"> <li>Identify soil types and the quantity and percentage of pervious and impervious surface for pre-project and project conditions;</li> </ul>	<ul style="list-style-type: none"> <li>Soil types and the quantity and percentage of pervious and impervious surface for pre-project and post-development conditions are provided in Appendix A.</li> </ul>
<ul style="list-style-type: none"> <li>Identify known Environmentally Sensitive Areas (ESAs) and Areas of Special Biological Significance (ASBSs) within the vicinity and their proximity to the project.</li> </ul>	<ul style="list-style-type: none"> <li>ESAs and ASBSs within the vicinity of the project are discussed in Section 1.8.2.</li> </ul>
<ul style="list-style-type: none"> <li>Identify the watershed in which the project is located and the: <ul style="list-style-type: none"> <li>- downstream receiving waters</li> <li>- known water quality impairments as included in the 303(d) List</li> <li>- applicable Total Maximum Daily Loads (TMDLs)</li> <li>- hydrologic conditions of concern, if any.</li> </ul> </li> </ul>	<ul style="list-style-type: none"> <li>The San Juan Creek Watershed and the San Mateo Creek Watershed are described in Section 1.7.1.</li> <li>Each sub-basin within the project area is described in more detail in the site assessment sections of Chapter 4 (e.g., the Cañada Chiquita Sub-basin is described in Section 4.2.1).</li> <li>303(d) listings and TMDLs are discussed in Section 1.8.1.</li> <li>Hydrologic conditions of concern are discussed in general in Section 1.7.3, and specifically for each sub-basin in the Site Assessment sections of Chapter 4 (e.g., hydrologic conditions of concern for Cañada Chiquita are discussed in Section 4.2.1).</li> </ul>
<b>7. Best Management Practices (BMPs)</b>	
<ul style="list-style-type: none"> <li>Include a Separator and Tab for Section IV for ready reference.</li> </ul>	<ul style="list-style-type: none"> <li>Will be included in future WQMP submittals.</li> </ul>
<ul style="list-style-type: none"> <li>Describe how the project complies with each post-construction water quality-related condition of approval.</li> </ul>	<ul style="list-style-type: none"> <li>Will be included in future WQMP submittals.</li> </ul>

<b>LIP WQMP Template Element</b>	<b>RMV Conceptual WQMP Element</b>
<ul style="list-style-type: none"> <li>The WQMP shall identify Best Management Practices (BMPs) that will be used on-site to control predictable pollutant runoff, and shall identify, at a minimum, the measures specified in the Countywide Water Quality Management Plan (WQMP) and NPDES Drainage Area Management Plan (DAMP), the assignment of long-term maintenance responsibilities (specifying the developer, parcel owner, maintenance association, lessee, etc.), and the location(s) of all structural BMPs.</li> </ul>	<ul style="list-style-type: none"> <li>Chapter 4 identifies the proposed BMPs by sub-basin for each Planning Area. Further detail will be included in future WQMP submittals.</li> <li>The Stormwater BMP Operation and Maintenance Program is presented at a conceptual level in Section 4.1.4. Further detail will be included in future WQMP submittals.</li> </ul>
<ul style="list-style-type: none"> <li>Routine Source Control BMPs are required to be incorporated in all new development redevelopment projects unless not applicable. Indicate in the tables provided all BMPs to be incorporated in the project. For those designated as not applicable, state brief reason why.</li> </ul>	<ul style="list-style-type: none"> <li>Routine source control BMPs are identified in Section 4.1.3.</li> </ul>
<ul style="list-style-type: none"> <li>List and describe all the source control (“routine” structural and non-structural) BMPs; show locations of structural BMPs in the project plans;</li> </ul>	<ul style="list-style-type: none"> <li>Routine source control BMPs are identified in Section 4.1.3.</li> <li>Locations of structural BMPs will be identified in future WQMP submittals.</li> </ul>
<ul style="list-style-type: none"> <li>List and describe, including locations, all site design BMPs employed in the project; show locations of site design BMPs in the project plans;</li> </ul>	<ul style="list-style-type: none"> <li>Site design BMPs are identified in Section 4.1.2.</li> <li>Locations of site design BMPs will be identified in future WQMP submittals.</li> </ul>
<ul style="list-style-type: none"> <li>Describe project design characteristics/features used to implement each BMP;</li> </ul>	<ul style="list-style-type: none"> <li>Implementation of site design options/ characteristics are listed in Table 4-1.</li> </ul>
<ul style="list-style-type: none"> <li>List and describe any treatment BMPs (designated to address specific pollutant problems identified in the water quality planning process, runoff management plan, CEQA process or similar watershed planning);</li> </ul>	<ul style="list-style-type: none"> <li>Treatment BMPs are described in general in Section 3.4 and specifically for each sub-basin in Chapter 4 (e.g., BMP facilities and sizing for Cañada Chiquita are listed in Tables 4-7 and 4-8).</li> </ul>
<ul style="list-style-type: none"> <li>Describe how the BMPs listed in the WQMP comply with each post-construction water quality-related condition of approval for this project.</li> </ul>	<ul style="list-style-type: none"> <li>Will be included in future WQMP submittals.</li> </ul>
<ul style="list-style-type: none"> <li>Identify any scenic/slope/landscape easements or lots, and their role(s) in implementing applicable BMPs. Clearly describe (and depict in the plot plan) ownership and who will be responsible for maintenance.</li> </ul>	<ul style="list-style-type: none"> <li>Will be included in future WQMP submittals.</li> </ul>



LIP WQMP Template Element	RMV Conceptual WQMP Element
<b>8. Inspection/Maintenance Responsibility for BMPs</b>	
<ul style="list-style-type: none"> <li>• Include a Separator and Tab for Section V for ready reference.</li> <li>• Describe the party(ies) responsible for source control, site design and treatment control BMPs. Include name, title, company, address and telephone number.</li> <li>• Inspection and Maintenance Responsibility and Frequency Matrix: <ul style="list-style-type: none"> <li>- Specify each source control, site design and treatment control BMP;</li> <li>- Name, title, company, and telephone number(s) of the party(ies) responsible for inspecting and maintaining each BMP;</li> <li>- Inspection and maintenance activity(ies) required;</li> <li>- Minimum frequency of inspection and maintenance necessary to ensure full implementation and effectiveness of each BMP.</li> </ul> </li> </ul>	<ul style="list-style-type: none"> <li>• The Stormwater BMP Operation and Maintenance Program is presented at a conceptual level in Section 4.1.4. Further detail will be included in future WQMP submittals.</li> </ul>
<b>9. Location Map, Plot Plan, &amp; BMP Details</b>	
<ul style="list-style-type: none"> <li>• Include a Separator and Tab for Section VI for ready reference.</li> </ul>	<ul style="list-style-type: none"> <li>• Will be included in future WQMP submittals.</li> </ul>
<ul style="list-style-type: none"> <li>• Prepare 11” x 17” plot plan(s). The plot plan(s) shall be readable and depict the following:</li> <li>• A table with the following: North arrow; Scale; Site area in square feet and/or acres; Number of units each building/tenant space as projected at the time of the drafting of the WQMP; Type of use (or range of uses allowed) in each building/tenant space as projected at the time of the drafting of the WQMP.</li> <li>• All source control (structural) BMPs proposed. Also include detail drawings as separate exhibits as necessary to demonstrate compliance with each BMP. Each detail shall include the BMP title (and number if any), and shall depict how the design features of the project implement each BMP.</li> <li>• Car wash racks;</li> <li>• Outdoor food preparation areas;</li> <li>• Trash container areas;</li> <li>• Washing/cleaning/maintenance/repair areas;</li> <li>• Outdoor storage areas;</li> <li>• Motor fuel dispensing areas;</li> <li>• Loading docks (and drainage);</li> <li>• Parking areas.</li> <li>• Drainage flow information, including general surface flow lines, concrete or other surface ditches or channels, as well as storm drain facilities such as</li> </ul>	<ul style="list-style-type: none"> <li>• Will be included in future WQMP submittals.</li> </ul>

LIP WQMP Template Element	RMV Conceptual WQMP Element
catch basins and underground storm drain pipes and any receiving waters; <ul style="list-style-type: none"> <li>• Treatment control BMPs.</li> </ul>	
<b>9. Educational Materials Included</b>	
<ul style="list-style-type: none"> <li>• Include a Separator and Tab for Section VII for ready reference.</li> <li>• Each educational handout included shall be listed by name in the table of contents. Include a cover page with the name of each educational handout attached as part of the WQMP.</li> </ul>	<ul style="list-style-type: none"> <li>• Will be included in future WQMP submittals.</li> </ul>

## 1.7 ENVIRONMENTAL SETTING

The following geomorphic, hydrologic, and biological information is summarized from the Baseline Geomorphic and Hydrologic Conditions Report (PCR et al, 2002). As part of developing the Baseline Report, extensive field reconnaissance, as required in Local WQMP Section A-7.VI-3.2.4, was conducted.

### 1.7.1 Physical Setting

#### *San Juan Creek Watershed*

The San Juan Creek watershed, located in the southern portion of Orange County, encompasses a drainage area of approximately 176 square miles and extends from the Cleveland National Forest in the Santa Ana Mountains to the Pacific Ocean at Doheny State Beach near Dana Point Harbor. The upstream tributaries of the watershed flow out of steep canyons and widen into several alluvial floodplains. The major streams in the watershed include San Juan Creek, Bell Canyon Creek, Chiquita Creek, Gobernadora Creek, Verdugo Canyon Creek, Oso Creek, Trabuco Creek, and Lucas Canyon Creek. Elevations range from over 5,800 feet above sea level at Santiago Peak to sea level at the mouth of San Juan Creek (PCR et al, 2002).

The San Juan Creek watershed is bounded on the north by the Santiago Creek, Aliso Creek, and Salt Creek watersheds and on the south by the San Mateo Creek watershed. The Lake Elsinore watershed, which is a tributary of the Santa Ana River watershed, is adjacent to the eastern edge of the San Juan Creek watershed.

#### *San Mateo Creek Watershed*

The San Mateo Creek watershed is located in the southern portion of Orange County, the northern portion of San Diego County, and the western portion of Riverside County. The watershed is bounded on the north and west by the San Juan Creek watershed, to the south by the San Onofre Creek watershed, and to the northeast by the Lake Elsinore watershed. San Mateo

Creek flows 22 miles from its headwaters in the Cleveland National Forest to the ocean just south of the City of San Clemente. The total watershed is approximately 139 square miles and lies mostly in currently undeveloped areas of the Cleveland National Forest, the northern portion of Marine Corps Base Camp Pendleton (MCBCP), and ranch lands in southern Orange County (PCR et al, 2002). Major (named) streams in the watershed include Cristianitos Creek, Gabino Creek, La Paz Creek, Talega Creek, Cold Spring Creek, and Devil Canyon Creek. The WQMP includes only the portion of the San Mateo Creek drainage within Orange County (approximately 17 percent of the watershed). Elevations range from approximately 3,340 feet above sea level in the mountains of the Cleveland National Forest to sea level at the mouth of San Mateo Creek.

### **1.7.2 Climatic Conditions**

The Mediterranean climate in Southern California is characterized by brief, intense storms between November and March. It is not unusual for a majority of the annual precipitation to fall during a few storms in close time proximity to one another. The higher elevation portions of the watershed typically receive significantly greater precipitation due to the effect of the Santa Ana Mountains. In addition, rainfall patterns are subject to extreme variations from year to year and longer term wet and dry cycles. The combination of steep, short watershed, brief intense storms and extreme temporal variability in rainfall results in “flashy” systems where stream discharge can vary by several orders of magnitude over very short periods of time.

Southern California is characterized by wet and dry cycles, typically lasting up to 15 to 20 years. The WQMP area appears to be emerging from a wetter-than-normal cycle of years beginning in 1993 (Figure 1-5). Previously, five consecutive years of sub-normal rainfall and runoff occurred in 1987 through 1991. Prior droughts of note include severe droughts in 1976-77 and 1946-51. Previous notable wet periods in the past occurred in 1937-44 and 1978-83. An unusually long period of generally dry years extended from 1945 through 1977. During this period, rainfall was approximately 25 percent below normal. Both groundwater recharge and sediment transport were considerably diminished during this period. Dry conditions were sufficiently persistent during this period to cause lower groundwater levels and to contract the extent of riparian corridors. Additionally, landslide activity was lessened during this period.

The watersheds have been subject to numerous large-scale fires during the past 100 years. Most of these fire events were of human origin. The majority of ignitions have been associated with roadways, arson and person-related activities. Large fire events in the watersheds occurred in 1989, 1961, 1959, 1958, 1952, 1937, 1917 and 1915. The primary effects of these fires are a sharp increase in sediment yield and downstream channel aggradation for a period of time following the fire.

### **1.7.3 Geomorphology, Terrains, and Hydrology**

The San Juan Creek and San Mateo Creek watersheds are located on the western slopes of the Santa Ana Mountains, which are part of the Peninsular Ranges that extend from the tip of Baja California northward to the Palos Verdes peninsula and Santa Catalina Island.

There are three major geomorphic terrains found within the San Juan Creek and San Mateo Creek watersheds: sandy and silty-sandy, clayey, and crystalline (Figure 1-6). These terrains are manifested primarily as roughly north-south oriented bands of different soil types. The soils and bedrock that comprise the western portions of the San Juan Creek watershed (i.e., Oso Creek, Arroyo Trabuco, and the lower third of San Juan Creek) contain a high percentage of clays in the soils. The soils typical of the clayey terrain include the Alo and Bosanko clays on upland slopes and the Sorrento and Mocho loams in floodplain areas. In contrast, the middle portion of the San Juan basin, (i.e., Cañada Chiquita, Bell Canyon, and the middle reaches of San Juan Creek) is a region characterized by silty-sandy substrate that features the Cieneba, Anaheim, and Soper loams on the hillslopes and the Metz and San Emigdio loams on the floodplains. The upstream portions of the San Juan Creek watershed, which comprise the headwaters of San Juan Creek, Lucas Canyon Creek, Bell Creek, and Trabuco Creek, may be characterized as a "crystalline" terrain because the bedrock underlying this mountainous region is composed of igneous and metamorphic rocks. Here, slopes are covered by the Friant, Exchequer, and Cieneba soils, while stream valleys contain deposits of rock and cobbly sand. The upland slopes east of both Chiquita and Gobernadora Canyons are unique in that they contain somewhat of a hybrid terrain. Although underlain by deep sandy substrates, these areas are locally overlain by between two and six feet of exhumed hardpan (a cemented or compacted layer in soil that is impenetrable by roots).

Runoff patterns typical of each terrain are affected by basin slope, configuration of the drainage network, land use/vegetation, and, perhaps most importantly, the underlying terrain type. Although all three terrains exhibit fairly rapid runoff, undisturbed sandy slopes contribute less runoff than clayey ones because it is easier for water to infiltrate into the coarser substrate. During low to moderate storm events terrains influence the likelihood and extent of channel migration, avulsion, or incision. However, during extreme storm events, the influence of terrains is minimal and runoff is more strongly influenced by soil hydrogroup. For example, a Type C soil in a sandy terrain would produce less runoff during a 5-year event than a Type C soil in a clayey terrain. However, during a larger storm event, runoff from both terrains would be comparable (assuming similar vegetation, slope, and land use).

### ***San Juan Creek Watershed***

Hydrologically, the San Juan Creek watershed can be organized into three regions: (1) the western portion of the watershed with the highly developed Oso Creek Sub-basin and the moderately developed Trabuco Creek Sub-basin; (2) the relatively undeveloped sub-basins of the central San Juan watershed (i.e., Cañada Chiquita, Cañada Gobernadora, Bell Canyon, Lucas Canyon, Trampas Canyon and Verdugo Canyon); and (3) the steeper eastern headwater canyons. In the San Juan Creek watershed, many tributary valleys are comprised of sandy terrains and, as such, include swales that do not have a clearly defined channel form (i.e., channel-less swales).

Overall, infiltration in the San Juan Creek watershed is relatively low, due to the prominence of poorly infiltrating soils (e.g., 79.8 percent of the watershed is underlain by soil types C or D) and

the significant proportion of development in the western watershed. However, there are significant pockets of the watershed, particularly in the central watershed, which do have more permeable soils and offer better potential infiltration.

Results of HEC-1 model analysis the 2-year, 10-year, and 100-year storm events in the San Juan Creek watershed were included in the Baseline Report (PCR et al, 2002). Peak flows in San Juan Creek upstream of Horno Creek (approximately the location of the USGS stream flow gauge at La Novia Street, see Figure 1-7) predicted by the model ranged from 2,940 cubic feet per second (cfs) for the 2-year event to 44,120 cfs for the 100-year event.

### ***San Mateo Creek Watershed***

The 133.2 square mile San Mateo Creek watershed has two principal drainage systems that join in the lower stream valley, 2.7 miles upstream of the ocean. The sub-basins of interest, including La Paz, Gabino, Cristianitos, Blind, and Talega Canyons upstream of the Cristianitos and San Mateo creek confluence, are located in the western watershed north of the main stem of San Mateo Creek. Approximately 17 percent of the total runoff in the San Mateo Creek basin emanates from these tributaries.

Overall, infiltration in the San Mateo Creek watershed is relatively low due to the prominence of poorly infiltrating soils (e.g., 89.8 percent of the watershed is underlain by soil types C or D). However, there are portions of the watershed along the tributary stream corridors which do have more permeable soils and offer higher infiltration.

Results of HEC-1 model analysis the 2-year, 10-year, and 100-year storm events were included in the Baseline Report for Cristianitos Creek downstream of Talega Canyon and in San Mateo Creek downstream of Cristianitos Creek. Peak flows in Cristianitos Creek predicted by the model ranged from 740 cfs for the 2-year event to 11,800 cfs for the 100-year event. Peak flows in San Mateo Creek downstream of Cristianitos Creek predicted by the model ranged from 3,200 cfs for the 2-year event to 47,070 cfs for the 100-year event.

## **1.7.4 Water Quality**

### ***Surface Water Quality***

Pollutant pathways and cycles within diverse settings such as the San Juan Creek and San Mateo Creek watersheds can be complex. Although the biogeochemical relationships that govern the fate of different constituents can be complicated, a number of generalizations are possible regarding the effect of the environmental setting and the terrains on water quality. In general, pollutants are transported by stormwater runoff and dry weather flows. Pollutants are either in dissolved form, particulate form, or are adsorbed to other particles in the water such as colloidal clays. The type and availability of particulates and pH affect the distribution of pollutants between the dissolved and particulate-bound forms. Therefore, land use characteristics that

promote infiltration and slow the flow of water allowing sediments to settle or filter out are important factors that control pollutant mobility.

Geology can also have a direct impact on specific water quality constituent concentrations. For example, the Monterey shale bedrock, which occurs in several of the San Juan Creek sub-basins, has been reported to be a source of high levels of phosphate and certain metals, such as cadmium (PCR et al, 2002).

Terrains can influence the mobilization, loading, and cycling of pollutants. Some general water quality characteristics of the major terrains in the San Juan Creek watershed and the San Mateo watershed are:

- *Sandy terrains.* Sandy terrains generally favor infiltration of rainfall and therefore have the potential to direct pollutants mobilized in low to moderate rainfall events into sub-surface pathways, with little or no actual biogeochemical cycling taking place in surface waters. Sequestered in sands, pollutants have the opportunity to degrade and attenuate via contact with soils and plants in the root/vadose zones before passage to groundwater or mobilization and transport to surface waters during larger storm events.
- *Silty terrains.* Silty terrains are characterized by higher runoff rates and tend to favor surface water pathways more than sandy terrains (but less than clayey terrains). Silty substrates can also be a significant source of turbidity (i.e., fine sediments). Conversely, the finer sediments derived from the silty substrates promote the transport of metals and certain pesticides in particulate form. This makes them less-readily available in first and second-order stream reaches, but potentially allows transport to higher order streams and subsequent deposition over long distances.
- *Clayey terrains.* Clayey terrains are characterized by very high rates of surface runoff during low and moderate storm events. Although clay soils are generally quite resistant to erosion, they can be very significant sources of turbidity during extreme or high intensity rainfall events when erosion occurs and/or headcutting or incision within the stream bed begins.
- *Crystalline terrains.* Crystalline terrains are common only in the uppermost reaches of the San Juan and San Mateo Creek systems where development and agricultural activities are absent. Similar to clayey terrains and in contrast to sandy terrains, during low to moderate rainfall events, primary pollutant pathways will be in surface water flow, leading to the potential for rapid mobilization and transport of constituents. Unlike clayey terrains, however, the crystalline substrates tend to generate coarse (rather than fine) sediments and thus are not a significant source of the finer particles that cause turbidity. Like all terrain types, extreme events will likely result in the mobilization and transport of all sizes of sediments from these areas.

### *Orange County Monitoring Data*

Balance Hydrologics (Balance Hydrologics, 2001a) performed a literature review and compilation of available water quality data in the SAMP study area. Most of the available monitoring data were from the San Juan Creek watershed; less data were available from the San Mateo Creek watershed. The majority of water quality data from San Juan Creek were collected by the Orange County Resources and Development Management Department (OCRDMD) in the 1990's at three monitoring stations (Figure 1-7):

- The La Novia Street Bridge monitoring station is located on the main stem of San Juan Creek in San Juan Capistrano. The watershed at this point includes all terrain types and diverse land-uses, including urban, grazing, nurseries, and mining uses. Monitoring data include a significant number of dry weather samples in addition to storm monitoring data.
- The Caspers Regional Park station is on the main stem of San Juan Creek approximately 10 miles upstream from the La Novia Street Bridge station. The majority of the watershed at this point is protected open space coastal scrub and chaparral on crystalline terrains. Monitoring data from station is less extensive than the La Novia Street Bridge station.
- The Mission Viejo station in Oso Creek represents mostly urban land uses on clayey terrains.

Available TSS monitoring data from Orange County are summarized in Table 1-3. In general, elevated TSS concentrations are strongly associated with runoff from winter storm events. It is generally expected that TSS concentrations in storm runoff will be greater from open and agricultural land uses than from urban land uses, where impervious surfaces and urban landscaping limit sediment delivery. Stormwater monitoring data from the San Juan Creek and Oso Creek Watershed are consistent with this expected trend. The average TSS concentration at the Caspers Park stations (predominantly open) is substantially greater than average TSS concentrations at the Mission Viejo station (predominantly urban) and the La Novia station (mixed land-uses). These data suggest that TSS concentrations in runoff from the proposed developments should, on average, be less than existing in-stream TSS concentrations during storm runoff conditions.

**Table 1-3: Average TSS Concentrations from Orange County Monitoring, 1991-1999**

	<b>Caspers Regional Park (open space)</b>	<b>La Novia (mixed land use)</b>	<b>Mission Viejo (urban land use)</b>
No. Samples	12	43	79
No. Non-Detects	1	1	1
TSS (mg/L)	1555	326	296

Source: Balance Hydrologics, 2001a

Nutrient monitoring data from Orange County are summarized in Table 1-4 and Table 1-5. Nutrient data are shown as a function of 3-day antecedent rainfall measured at the Tustin rain gage located approximately 15 miles to the northwest of the water quality stations on San Juan and Oso Creeks.

Data from San Juan Creek indicate that nitrogen concentration increases between the upstream location at Caspers Park (open space) and the downstream station at La Novia (mixed land-use). All stations show a general increase in nitrogen concentration with increasing antecedent rainfall. Comparison between the San Juan and Oso Creek data reveals that nitrate concentrations in low flows are elevated at the urban station (Mission Viejo), and that storm flow concentrations at the urban station are comparable to or higher than those from the San Juan Watershed. These data suggest that non-stormwater runoff from urbanized areas could result in increased nitrogen concentrations.

Phosphate data from San Juan Creek in Table 1-5 reveal an opposite trend from nitrate. Phosphate concentrations generally decrease between the upstream station (open space land use) and the downstream station (mixed land use). An explanation is based on the general trend that sediment loads are greater in storm runoff from vacant and agricultural land-uses (upstream monitoring location) in comparison with storm runoff from urban land-uses (mixed land-uses at downstream location). Phosphorus strongly adheres to soil particles, thus greater phosphorus loads are expected with greater sediment loads and higher TSS values (Table 1-3). For example, the median phosphate concentration at Caspers Regional Park is about 3.6 mg/l for data in which the 3-day antecedent rainfall is 0.51-1.0 inches, far higher than comparable values at the La Novia and Mission Viejo stations.



**Table 1-4: Average Nitrate Concentrations from Orange County Monitoring, 1991-1999 (mg/L NO<sub>3</sub> as N)**

3-day precedent rainfall (in)	San Juan Creek						Oso Creek		
	Caspers Regional Park (open space)			La Novia (mixed land use)			Mission Viejo (urban land use)		
	# samples	mean	median	# samples	mean	median	# samples	mean	median
0	32	0.1	0.1	43	0.3	0.2	10	0.9	1
0.01-0.5	10	0.2	0.1	21	0.5	0.5	23	1.2	1.3
0.51-1.0	6	0.9	0.1	15	1.2	1.2	15	1.2	1.2
1.01-1.5	1	0.7	0.7	7	1.5	1.7	15	1.4	1.3
>1.5	0	-	-	5	0.4	0.4	18	1	0.8

Source: Balance Hydrologics, 2001a

**Table 1-5: Average Phosphate Concentrations from Orange County Monitoring, 1991-1999 (mg/L PO<sub>4</sub> as P)**

3-day precedent rainfall (in)	San Juan Creek						Oso Creek		
	Caspers Regional Park (open space)			La Novia (mixed land use)			Mission Viejo (urban land use)		
	# samples	mean	median	# samples	mean	median	# samples	mean	median
0	31	0.1	0.1	43	0.1	0.1	10	0.7	0.6
0.01-0.5	9	0.4	0.1	21	0.2	0.2	23	0.4	0.3
0.51-1.0	5	4.4	3.6	15	0.6	0.4	15	0.7	0.5
1.01-1.5	1	1.0	1.0	7	0.7	0.7	15	0.7	0.6
>1.5	0	-	-	5	0.5	0.5	18	1	0.5

Source: Balance Hydrologics, 2001a

Dry weather and stormwater data collected by Orange County for trace metals is summarized in Table 1-6. Most samples were analyzed only for total metal concentrations. A few samples from the Oso Creek station were analyzed for dissolved metals. Data from the Caspers station had a high percentage of non-detects, and high detection limits, especially for lead.

Data from San Juan Creek reveal consistently greater average total metal concentrations during storm flow conditions. This is expected due to the affinity of metals to adsorb to soil particles, which are present in larger quantities in storm runoff.

Comparisons of average total metal concentration in storm flow measurements between the Mission Viejo Station (primarily urban) and those from Caspers Park (primarily open space) and La Novia (mixed use) provides an indication of the effect of development. For copper, total metal concentrations increase with greater levels of development. This is the expected trend,

because heavy metal concentrations in general have been found to increase with urbanization. For lead and zinc, the data reveal a decreasing trend in total metal concentration with increasing levels of urbanization, which is somewhat counter to the expected trend. A partial explanation could be related to differences in the runoff regimes at the three stations resulting in different levels of dilution and/or sediment loads. Balance Hydrologics [2001] indicated that the zinc values at the Caspers Park Station were abnormally high, and postulated that they might be indicative of high background zinc levels in the San Juan Creek watershed. Average hardness values at the Caspers Park station also exhibit unexpected trends. Typically, hardness values are expected to decrease with increasing flows; however the opposite trend at the Caspers station suggests the possibility of natural sources of carbonates.

**Table 1-6: Average Trace Metal Concentrations from Orange County Monitoring, 1991-1999**

	Caspers Regional Park (open space)		La Novia (mixed land use)		Mission Viejo (urban land use)	
	Storm flows <sup>1</sup>	Dry weather flows <sup>1</sup>	Storm flows <sup>1</sup>	Dry weather flows <sup>1</sup>	Storm flows <sup>1</sup>	Storm flows <sup>2</sup>
No. Samples	16	9	47	11	79	14
Hardness (mg/L as CaCO <sub>3</sub> )	230	150	260	290	560	-
Copper						
No. Non-Detects	10	7	20	6	17	0
Mean conc. (µg/L)	15.8	5.5	20.7	4.0	23.8	13.8
Lead						
No. Non-Detects	6	7	20	9	18	10
Mean conc. (µg/L)	11.8	4.7	7.3	1.3	6.2	1.4
Zinc						
No. Non-Detects	1	2	6	2	2	0
Mean conc. (µg/L)	77.9	29.8	46.9	26.4	75.9	34.4

<sup>1</sup>Concentrations are for total metals

<sup>2</sup>Concentrations are for dissolved metals

Note: a value of one-half the detection was used for reported results below the detection limit)

Source: Balance Hydrologics, 2001a

### *Rancho Mission Viejo Monitoring Data*

Surface water quality data were collected at several stations within the San Juan and San Mateo watersheds by Rivertech, Inc. and Wildermuth Environmental, Inc. for Ranch Mission Viejo. Data were collected between October 2001 and March 2003 during five wet weather events and three dry weather flows at six stations of concern for this report. The monitoring station locations are summarized in Table 1-7 and are illustrated in Figure 1-7. Monitoring results are summarized in Table 1-8 through Table 1-13 and are included in Appendix C

The RMV monitoring data provide a snapshot of existing water quality in the project area. These data are qualitatively assessed below; however, the relatively small number of data collected limits confidence in interpretation of the monitoring data.

Average TSS concentrations from RMV wet weather monitoring in the San Juan Creek watershed (Table 1-8) were comparable to levels and trends observed in the Orange County monitoring data (Table 1-3). Average TSS concentrations were similar at the open space station at Caspers, and were substantially reduced and similar in magnitude in the developed watersheds (Mission Viejo vs. SW-6). There are no Orange County monitoring stations in the San Mateo Creek watershed. RMV monitoring data in Table 1-8 show that average TSS levels in the San Mateo Creek watershed were substantially greater than the San Juan Creek watershed, likely due to the silty terrains present in the Cristianitos and Upper Gabino sub-basins. These comparisons suggest that wet weather TSS monitoring data collected by Orange County is generally representative of existing and proposed conditions in the San Juan Creek watershed portion of the project area, but is not representative of conditions in the San Mateo Creek watershed, which has greater average TSS levels.

RMV monitoring of nutrient levels in wet weather flows are presented in Table 1-9. Average nitrate levels were low at all stations in both watersheds, and were generally comparable to average levels in the Orange County monitoring data (Table 1-4). The RMV data do not exhibit clear trends with land use, whereas the Orange County data exhibit slightly lower average concentrations at the open space station at Caspers. Phosphorus levels in wet weather monitoring data are also generally comparable between the RMV monitoring (Table 1-9) and the Orange County monitoring data (Table 1-5). Both data sets show slightly higher average phosphorus levels at the open space station at Caspers.

RMV monitoring of nutrient levels in dry weather flows in the San Juan Creek watershed (Table 1-10) show no detections at most stations, with the exception of moderately high levels at SW-1, possibly due to nursery sources, and a small amount of nitrate detected below the urban catchment in Coto de Caza.

RMV monitoring results of fecal coliform bacteria are presented in Tables 1-12 and 1-13 for wet and dry weather conditions, respectively. In the San Juan Creek watershed, wet weather fecal coliform levels were generally consistent with nationwide monitoring information indicating average fecal coliform in the range of 5,000 to 20,000 MPN/100mL, with higher fecal coliform

concentrations in the developed watershed (SW-6). Monitoring information from the open space land uses in the San Mateo Creek watershed (SW-8 and SW-9) also show very high fecal coliform levels in wet weather flows, possibly due to sources from grazing activities in the Gabino Sub-basin. Fecal coliform levels in dry weather samples in the San Juan Creek watershed were low, with the exception of moderately elevated levels at SW-1.

RMV monitoring of trace metals in wet weather flows are presented in Table 1-13. Average dissolved metal concentrations were generally low, even in the urban catchment (SW-6). In fact, average dissolved metal concentration at SW-6 were substantially lower than the average levels in the Orange County data in the urban catchment in Mission Viejo (see Table 1-6).

**Table 1-7: Surface Water Monitoring Station Locations**

Watershed	Stream	Station	Description	Sample Type
San Juan	San Juan	SW-1	San Juan Creek at Equestrian Park. Large watershed with mixed land uses and geomorphic terrains	Continuous
	San Juan	SW-2	San Juan Creek at Caspers Regional Park. Small watershed without development, crystalline terrain	Grab
	Gobernadora Creek	SW-6	Gobernadora Creek downstream of Coto de Caza. Small developed watershed with sandy terrain.	Continuous
	Gobernadora Creek	SW-7	Gobernadora Creek at the mouth of the canyon.	Grab
San Mateo	Cristianitos Creek	SW-8	Downstream of the confluence of Gabino and Cristianitos Creeks. Undeveloped crystalline terrain.	Continuous
	Gabino Creek	SW-9	Downstream of the confluence of Gabino and La Paz Creeks. Undeveloped crystalline terrain.	Grab

**Table 1-8: Average TSS Concentrations during Wet and Dry Weather**

	SW-1 San Juan Creek at Equestrian Park (mg/L)	SW-2 San Juan Creek at Caspers (mg/L)	SW-6 Gobernadora Downstream of Coto De Caza (mg/L)	SW-7 Gobernadora Upstream of Confluence with San Juan Creek (mg/L)	SW-8 Cristianitos Creek (mg/L)	SW-9 Gabino Creek (mg/L)
Wet Weather	913	1372	368	432	7067	4767
Dry Weather	36	NA	10	10	NA	NA

NA – Not Analyzed

**Table 1-9: Average Nutrient Concentrations during Wet Weather**

Nutrient	SW-1 San Juan Creek at Equestrian Park (mg/L)	SW-2 San Juan Creek at Caspers (mg/L)	SW-6 Gobernadora Downstream of Coto De Caza (mg/L)	SW-7 Gobernadora Upstream of Confluence with San Juan Creek (mg/L)	SW-8 Cristianitos Creek (mg/L)	SW-9 Gabino Creek (mg/L)
Ammonia-N	ND	ND	ND	ND	NA	NA
Nitrate-N	1.2	0.78	0.86	0.54	0.63	0.60
Total Phosphorus	0.96	1.5	0.82	0.83	0.73	0.64

ND – None Detected

NA – Not Analyzed

**Table 1-10: Average Nutrient Concentrations during Dry Weather**

Nutrient	SW-1 San Juan Creek at Equestrian Park (mg/L)	SW-2 San Juan Creek at Caspers (mg/L)	SW-6 Gobernadora Downstream of Coto De Caza (mg/L)	SW-7 Gobernadora Upstream of Confluence with San Juan Creek (mg/L)	SW-8 Cristianitos Creek (mg/L)	SW-9 Gabino Creek (mg/L)
Ammonia-N	0.35	NA	ND	ND	NA	NA
Nitrate-N	9.0	NA	ND	0.10	NA	NA
Orthophosphate	2.8	NA	ND	ND	NA	NA

ND – None Detected

NA – Not Analyzed

**Table 1-11: Fecal Coliform Data during Storm Events**

Sample Date	SW-1 San Juan Creek at Equestrian Park (MPN/100 mL)	SW-2 San Juan Creek at Caspers (MPN/100 mL)	SW-6 Gobernadora Downstream of Coto De Caza (MPN/100 mL)	SW-7 Gobernadora Upstream of Confluence with San Juan Creek (MPN/100 mL)	SW-8 Cristianitos Creek (MPN/100 mL)	SW-9 Gabino Creek (MPN/100 mL)
2/12/03	800	NA	1700	5000	5000	300
2/25/03	9000	8000	28000	13000	23500	24000
3/15/03	3000	800	16000	9000	16000	16000
2/13/03	8000	NA	13000	NA	8000	NA
3/16/03	NA	NA	NA	NA	16000	NA
<b>Geometric Mean</b>	3626	2530	9975	8363	11920	4866

NA – Not Analyzed

**Table 1-12: Fecal Coliform Data during Dry Weather**

Sample Date	SW-1 San Juan Creek at Equestrian Park (MPN/100 mL)	SW-2 San Juan Creek at Caspers (MPN/100 mL)	SW-6 Gobernadora Downstream of Coto De Caza (MPN/100 mL)	SW-7 Gobernadora Upstream of Confluence with San Juan Creek (MPN/100 mL)	SW-8 Cristianitos Creek (MPN/100 mL)	SW-9 Gabino Creek (MPN/100 mL)
9/24/02	1600	NA	300	70	NA	NA

NA – Not Analyzed

**Table 1-13: Average Trace Metal Concentrations during Wet Weather**

Trace Metal	SW-1 San Juan Creek at Equestrian Park (µg/L)	SW-2 San Juan Creek at Caspers (µg/L)	SW-6 Gobernadora Downstream of Coto De Caza (µg/L)	SW-7 Gobernadora Upstream of Confluence with San Juan Creek (µg/L)	SW-8 Cristianitos Creek (µg/L)	SW-9 Gabino Creek (µg/L)
Cadmium, Dissolved	0.09	0.12	0.06	0.06	0.17	0.05
Copper, Dissolved	2.5	5.5	1.7	1.6	6.3	6.5
Lead, Dissolved	0.17	0.63	0.91	0.24	1.1	0.58
Zinc, Dissolved	5.3	10.4	3.9	4.9	21.8	11.5

*Orange County Health Care Agency Bacteria Study*

The Orange County Public Health Laboratory conducted a monitoring study in 1998 in the San Juan Creek watershed to help determine the sources of pathogen indicators during *dry weather* conditions (Moore et al, 2002). Monitoring stations were located in the ocean, in creeks in the San Juan Creek watershed, and in storm drains. One finding of the study was that “the highest concentrations of fecal coliforms and Enterococcus were found in the storm drains as compared to the creeks and ocean sampling sites. Samples taken from creek sites distant to human habitat also had low to moderate levels of bacteria, suggestive of fecal contamination by non-human sources.”

Data obtained in San Juan Creek above the Ortega Highway (SJ30) indicated a log mean concentration for fecal coliform of about 300 colony forming units (CFUs) compared with a storm drain at La Novia Bridge (SJ07) where the concentration was about 1,400 CFUs.

Pathogen indicator concentrations during *wet weather* tend to be higher than during dry weather.

### **1.7.5 Biological Resources**

Although not the focus of this report, a brief overview of biological resources is provided here. A total of 16 vegetation community types are mapped within the San Juan Creek and San Mateo Creek watersheds (PCR et al, 2002). Riparian woodlands and forests occur along most portions of the stream corridors. Some of the major stands of riparian vegetation can be found in the following areas: San Juan to the confluence with Oso Creek, Cañada Gobernadora tributaries, Bell Canyon, and many of the other tributaries to San Juan and San Mateo creeks. The slopes along these corridors are dominated by coastal sage scrub or chaparral communities. With increasing elevation, chaparral communities replace coastal sage. Coastal sage scrub is restricted to xeric, south facing slopes. Oak woodlands and forest become common in the upper reaches of the watersheds on north-facing slopes and along drainages. The proposed development area also contains slope wetlands, concentrated mainly along the toe of slopes in Cañada Chiquita.

The San Juan Creek watershed supports a large variety of sensitive species. Information on sensitive species is set forth in the Biological Resources Section of the GPA/ZC EIR.

## **1.8 REGULATORY SETTING**

### **1.8.1 Clean Water Act**

#### *Overview*

In 1972, the Federal Water Pollution Control Act (later referred to as the Clean Water Act) was amended to require that the discharge of pollutants to waters of the United States from any point source be effectively prohibited, unless the discharge is in compliance with a National Pollutant Discharge Elimination System (NPDES) permit. In 1987, the Clean Water Act (CWA) was again amended to require that the Environmental Protection Agency (EPA) establish regulations for permitting of stormwater discharges (as a point source) by municipal and industrial facilities and construction activities under the NPDES permit program. The EPA published final regulations regarding stormwater discharges on November 16, 1990. The regulations require that municipal separate storm sewer system (MS4) discharges to surface waters be regulated by a NPDES permit.

In addition, the CWA requires the States to adopt water quality standards for water bodies and have those standards approved by the EPA. Water quality standards consist of designated beneficial uses for a particular water body (e.g. wildlife habitat, agricultural supply, fishing etc.), along with water quality criteria necessary to support those uses. Water quality criteria are set concentrations or levels of constituents – such as lead, suspended sediment, and fecal coliform bacteria – or narrative statements which represent the quality of water that support a particular use. In 2000, EPA established numeric water quality criteria for toxic constituents in waters with human health or aquatic life designated uses in the form of the California Toxics Rule (“CTR”) (40 CFR 131.38).

### *CWA Section 303(d) - TMDLs*

When designated beneficial uses of a particular water body are being compromised by water quality, Section 303(d) of the Clean Water Act requires identifying and listing that water body as “impaired”. Once a water body has been deemed impaired, a Total Maximum Daily Load (“TMDL”) must be developed for each water quality constituent that compromises a beneficial use. A TMDL is an estimate of the total load of pollutants, from point, non-point, and natural sources, that a water body may receive without exceeding applicable water quality standards (with a “factor of safety” included). For point sources, including stormwater, the load allocation is referred to as a “Waste Load Allocation” whereas for nonpoint sources, the allocation is referred to simply as a “Load Allocation”. Once established, the TMDL allocates the loads among current and future dischargers into the water body. Table 1-14 lists the water bodies within the San Juan and San Mateo watersheds that have been included on the 2002 303(d) list.

As indicated in Table 1-14, the lower portion of San Juan Creek is listed for bacteria indicators. The SDRWQCB, along with U.S. EPA and Tetra Tech, Inc., have developed a Technical Draft titled “Bacteria-Impaired Waters TMDL Project I for Beaches and Creeks in the San Diego Region”. The pollutants addressed by the TMDL consist of the “indicator bacteria”, namely total and fecal coliform, and enterococcus bacteria, some species of which are pathogenic. This document is in a very preliminary form, with technical issues still to be resolved and public input to be considered prior to adoption by the SDRWQCB. It is presented here as it represents the currently available TMDL information.

For dry weather conditions, the TMDL was set equal to the fecal and enterococcus bacteria numeric water quality objectives (WQOs) for water contact (REC1) beneficial use defined in the Water Quality Control Plan for the San Diego Basin (San Diego Basin Plan) (SDRWQCB, 1994). For total coliform, the TMDL was set equal to the WQO for shellfish harvesting (SHELL) beneficial use. Because of the stringency of the SHELL WQO, interim targets based on REC1 were developed to provide adequate time for further investigation into the appropriateness of using the SHELL WQO.

For wet weather conditions, an interim numeric target was established based on a “reference approach” designed to account for uncontrollable natural sources of bacteria. The reference approach ensures that water quality objectives are at least as good as conditions observed in a reference watershed that represents natural conditions. The San Mateo Creek watershed was identified as the best candidate for assessment of natural background sources of bacteria. Monitoring data collected near the mouth of San Mateo Creek and at San Onofre State Beach were analyzed to estimate the percentage of samples that exceeded the water quality objectives. Because of the limited data collected at these stations, the SDRWQCB chose, as an interim condition, to use data collected by the LARWQCB in the Arroyo Sequit watershed. Data collected at Leo Carillo Beach indicated that 19 percent of wet weather fecal coliform data were observed to exceed the WQOs. This exceedance percentage is proposed as the interim reference target until additional data become available from reference locations within the San Diego



Basin. Based on selecting 1993 as a critical wet year, which represents the 92<sup>nd</sup> percentile rainfall amount for the period 1990 through 2002, the number of wet days in the San Juan Creek watershed for 1993 was estimated at 76 days. Applying the 19 percent exceedance allowable for natural sources, the number of days in the San Juan Creek watershed during which fecal coliform could exceed the WQOs is 14. It is recognized that this is an interim target that will be modified as additional data and analysis are conducted.

The Implementation Plan for this TMDL will be developed by the SDRWQCB at a future date. To the extent that this or other TMDLs are adopted in the future, the TMDLs and associated waste load allocations will be addressed in future RMV WQMPs (e.g., Master Area Plan WQMP, Sub-Area Plan WQMP, and final project-specific WQMP) as project elements become more defined.

**Table 1-14: 2002 CWA Section 303(d) Listings for the San Juan and San Mateo Watersheds**

<b>Water Body</b>	<b>Pollutant</b>	<b>Extent</b>	<b>TMDL Priority</b>	<b>TMDL schedule</b>
Pacific Ocean Shoreline, Lower San Juan HSA	Bacteria Indicators	1.2 miles	Medium	7/2004 – 11/2007
Lower San Juan Creek	Bacteria Indicators	1 mile and at mouth (6.3 acres)	Medium	7/2004 – 11/2007

***CWA Act Section 404 Dredge and Fill Permits***

Section 404 of the Clean Water Act establishes a program to regulate the discharge of dredged and fill material into waters of the United States, including wetlands. Activities in waters of the United States that are regulated under this program include fills for development, water resource projects (such as dams and levees), infrastructure development (such as highways and airports), and conversion of wetlands to uplands for farming and forestry. The SAMP/MSAA specifically addresses the 404 permitting requirements (including the Section 404(b) (1) Guidelines at 40 CFR 230, et seq).

***CWA Act Section 404(b)(1) Water Quality Guidelines***

EPA and the Corps have issued Section 404(b)(1) Guidelines (40 CFR 230) that regulate dredge and fill activities, including water quality aspects of such activities. Subpart C at Sections 230.20 thru 230.25 contains water quality regulations applicable to dredge and fill activities. Among other topics, these guidelines address: (a) discharges which alter substrate elevation or contours, suspended particulates, water clarity, nutrients and chemical content, current patterns and water circulation, water fluctuations (including those that alter erosion or sediment rates), and salinity gradients.

### ***CWA Section 401***

Section 401 of the Clean Water Act requires that any person applying for a federal permit or license which may result in a discharge of pollutants into waters of the United States must obtain a state water quality certification that the activity complies with all applicable water quality standards, limitations, and restrictions. No license or permit may be issued by a federal agency until certification required by Section 401 has been granted. Further, no license or permit may be issued if certification has been denied. CWA Section 404 permits and authorizations are subject to section 401 certification by the Regional Water Quality Control Boards (RWQCBs).

### ***California Toxics Rule***

The California Toxics Rule (CTR) is a federal regulation issued by the USEPA providing water quality criteria for toxic constituents in waters with human health or aquatic life designated uses in the State of California. CTR criteria are applicable to the receiving water body and therefore must be calculated based upon the probable hardness values of the receiving waters for evaluation of acute (and chronic) toxicity criteria. At higher hardness values for the receiving water, copper, lead, and zinc are more likely to be complexed (bound with) components in the water column. This in turn reduces the bioavailability and resulting toxicity of these metals.

Due to the intermittent nature of stormwater runoff (especially in Southern California), the acute criteria are considered to be more applicable to stormwater conditions and therefore used in assessing project impacts, while chronic criteria are more applicable to base flow conditions. Acute criteria represent the highest concentration of a pollutant to which aquatic life can be exposed for a short period of time without deleterious effects; chronic criteria equal the highest concentration to which aquatic life can be exposed for an extended period of time (four days) without deleterious effects.

When the CTR was promulgated in May 2000, the SWRCB developed implementation guidance titled the *Policy for Implementation of Toxics Standards for Inland Surface Waters, Enclosed Bays, and Estuaries of California* (SWRCB Resolution No. 2000-015, called the State Implementation Policy or SIP). The SIP applies to point source, non-ocean discharges. Neither the SIP nor the water quality criteria apply directly to discharges of stormwater runoff. Nonetheless, water quality criteria provide a basis for comparison to assess the potential for project discharges to affect the water quality of receiving waters. In this document, the CTR criteria are used as one measure to help evaluate the potential ecological impacts of stormwater runoff to the receiving waters of the Project.

### **1.8.2 California Porter-Cologne Act**

The federal CWA places the primary responsibility for the control of water pollution and for planning the development and use of water resources with the states, although it does establish certain guidelines for the states to follow in developing their programs. The CWA Section 101 requires that the chemical, physical, and biological integrity of the nation's waters be maintained.

California’s primary statute governing water quality and water pollution issues is the Porter-Cologne Water Quality Control Act of 1970 (Porter-Cologne Act). The Porter-Cologne Act grants the State Water Resource Control Board (SWRCB) and the Regional Water Quality Control Boards (RWQCBs) broad powers to protect water quality and is the primary vehicle for implementation of California’s responsibilities under the federal Clean Water Act. The Porter-Cologne Act grants the SWRCB and the RWQCBs authority and responsibility to adopt plans and policies, to regulate discharges to surface and groundwater, to regulate waste disposal sites and to require cleanup of discharges of hazardous materials and other pollutants. The Porter-Cologne Act also establishes reporting requirements for unintended discharges of any hazardous substance, sewage, or oil or petroleum product.

Each RWQCB must formulate and adopt a water quality plan for its region. The regional plans are to conform to the policies set forth in the Porter-Cologne Act and established by the SWRCB in its state water policy. The Porter-Cologne Act also provides that a RWQCB may include within its region plan water discharge prohibitions applicable to particular conditions, areas or types of waste. The RWQCBs are also authorized to enforce discharge limitations, take actions to prevent violations of these limitations from occurring and conduct investigations to determine the status of the quality of any of the waters of the state. Civil and criminal penalties are also applicable to persons who violate the requirements of the Porter-Cologne Act or SWRCB/RWQCB orders.

The Water Quality Control Plan for the San Diego Basin (San Diego Basin Plan) (SDRWQCB, 1994) provides quantitative and narrative criteria for a range of water quality constituents. Specific criteria are provided for the larger water bodies within the region and general criteria or guidelines are provided for bays and estuaries, inland surface waters, and ground waters. In general, the narrative criteria require that degradation of water quality does not occur due to increases in pollutant loads that will impact the designated beneficial uses of a water body. For example the San Diego Basin Plan requires that “Inland surface waters shall not contain suspended or settleable solids in amounts which cause a nuisance or adversely affect beneficial uses as a result of controllable water quality factors”.

Beneficial uses of the water bodies within the Project area listed in the San Diego Basin Plan are shown in Table 1-15.

**Table 1-15: Beneficial Uses of Receiving Waters**

Water Body	Beneficial Uses								
	MUN	AGR	IND	REC1	REC2	WARM	COLD	WILD	RARE
San Juan Creek	E	P	P	P	P	P	P	P	
Verdugo Canyon	E	P	P	P	P	P	P	P	

Water Body	Beneficial Uses								
	MUN	AGR	IND	REC1	REC2	WARM	COLD	WILD	RARE
Trampas Canyon	E	P	P	P	P	P	P	P	
Cañada Gobernadora	E	P	P	P	P	P	P	P	
Cañada Chiquita	E	P	P	P	P	P	P	P	
San Mateo Creek	E			P	P	P		P	P
Cristianitos Creek	E			P	P	P		P	
Gabino Creek	E			P	P	P		P	
La Paz Canyon	E			P	P	P		P	
Blind Canyon	E			P	P	P		P	
Talega Canyon	E			P	P	P		P	

P – Present or potential beneficial use

E – Excepted from MUN designation

California Marine State Water Quality Protection Areas (SWQPA) are defined in Section 36700(f) of the Public Resources Code (PRC) as “ a nonterrestrial marine or estuarine area designated to protect marine species or biological communities from an undesirable alteration in natural water quality, including, but not limited to, areas of special biological significance that have been designated by the State Water Resources Control Board through its water quality control planning process.” Point source waste or thermal discharges to SWQPAs are prohibited. There are a total of 34 areas along the California coastline; two of these areas in the San Diego Region. These areas do not include the coastal areas into which San Juan Creek or San Mateo Creek discharge.

### **1.8.3 State of California Nonpoint Source Plan**

The Nonpoint Source (NPS) Program’s roots were established in 1988 in response to the federal Clean Water Act Section 319 (CWA 319). CWA 319 required states to develop assessment reports that described the state’s NPS problems and to establish an NPS management program to control or prevent the problems. In 1998, the State of California began the implementation of its Fifteen-Year Program Strategy for the Nonpoint Source Pollution Prevention Program (NPS Program), as described in the *Plan for California’s Nonpoint Source Pollution Control Program*. The Strategy prescribed the vision and goals of the NPS Program, which included basic process components of Planning, Coordination, Implementation, Monitoring and Tracking, and Assessment of NPS Program achievements.

The NPS Plan expresses a preference for watershed-scale approaches to control point and NPS pollution. The NPS Plan achieves this goal by dealing with NPS pollution via 61 Management Measures (MMs). Management measures serve as general guidelines for the control and prevention of polluted runoff and the attainment of water quality goals. Site-specific management practices are then used to achieve the goals of each management measure.

Specifically, the Plan:

- Adopts 61 MMs as goals for six NPS categories (agriculture, forestry, urban areas, marinas and recreational boating, hydromodification, and wetlands/riparian areas/vegetated treatment systems);
- Uses a "Three-Tiered Approach" for addressing NPS pollution problems (Tier 1: Self-Determined Implementation of Management Practices [formerly referred to as "voluntary implementation"]; Tier 2: Regulatory Based Encouragement of Management Practices; and Tier 3: Effluent Limitations and Enforcement Actions).
- Expresses a preference for managing NPS pollution on a watershed scale where local stewardship and site-specific management practices can be implemented through comprehensive watershed protection or restoration plans.

The SWRCB, California Coastal Commission, and other State agencies have identified fifteen MMs to address urban sources of pollution, which utilize two primary strategies: (1) the prevention of pollutant loadings and (2) the treatment of unavoidable loadings. The Urban Category MM strategy emphasizes pollution prevention and source reduction practices over treatment practices, as the most cost-effective means of controlling urban runoff pollution from affecting waters of California.

The NPS Program Plan acknowledges the types of pollution that are derived from urban runoff, which are addressed through a variety of regulatory and non-regulatory programs in the State. Each State department and program may have separate and distinct programmatic objectives and authorities to enforce them, but all maintain the common goal of reducing or eliminating the effects of polluted runoff in waters of the State. These programs include the TMDL and the NPDES Stormwater Programs as implemented by SWRCB and the RWQCBs; the coastal planning and permitting programs that are the jurisdiction of the California Coastal Commission (CCC) and San Francisco Bay Conservation Development Commission (BCDC); and other local ordinances and initiatives. All of these are part of the strategy that California is utilizing to address urban sources of pollution.

The Urban NPS Program and Storm Water Programs are related in that both programs address aspects of urban runoff pollution. With respect to programs within the SWRCB and the RWQCBs, urban runoff is addressed primarily through the National Pollution Discharge Elimination System (NPDES) Permitting Program. The SWRCB NPS Program will apply where runoff is not regulated as a permitted point source discharge, such as to agriculture areas.

#### **1.8.4 Municipal NPDES Permit**

The San Diego RWQCB issued the third term permit (Order No. R9-2002-0001) for stormwater discharges in southern Orange County to the County, the Orange County Flood Control District, and the Orange County cities within the San Diego Region (collectively “the Co-permittees”) in February 2002. This permit regulates stormwater discharges in the Project area. The NPDES permit details requirements for new development and significant redevelopment projects, including specific sizing criteria for treatment Best Management Practices (BMPs).

To implement the requirements of the NPDES permit, the Co-permittees have developed a 2003 Drainage Area Management Plan (DAMP) that includes a New Development and Significant Redevelopment Program (OCDMD, 2003). This New Development and Significant Redevelopment Program provides a framework and a process for following the NPDES permit requirements and incorporates watershed protection/stormwater quality management principles into the Co-permittees’ General Plan process, environmental review process, and development permit approval process. The New Development and Significant Redevelopment Program includes a Model Water Quality Management Plan (WQMP) that defines requirements and provides guidance for compliance with the NPDES permit requirements for project specific planning, selection, and design of BMPs in new development or significant redevelopment projects. The Model WQMP also defines two levels of analysis: a preliminary or conceptual WQMP at a planning level of detail suitable for supporting a CEQA analysis; and a project-specific WQMP at a project level of detail that will be submitted as part of the development approval permitting process.

Local jurisdictions must adopt a Local Implementation Plans (LIPs) that describe the process by which each Permittee will approve project-specific WQMPs as part of the development plan and entitlement approval process for discretionary projects, and prior to issuing permits for ministerial projects. The County of Orange and the Orange County Flood Control District LIP (2003 DAMP Appendix A) was adopted in July, 2003. Exhibit A-7.VI of the County’s Local Implementation Plan, the County of Orange Local WQMP, contains the requirements placed upon all new development and significant redevelopment projects in the unincorporated County south of El Toro Road. These requirements apply to the RMV project.

The RMV project is considered by the Orange County LIP as a “priority” new development and significant redevelopment project and is therefore required to develop and implement a Project WQMP that addresses:

- Regional or watershed programs (if applicable)
- Pollutants of Concern
- Hydrologic Conditions of Concern
- Routine structural and non-structural Source Control BMPs

- Site Design BMPs (as applicable);
- Treatment Control BMPs (Treatment Control BMP requirements may be met through either project specific (on-site) controls or regional or watershed management controls that provide equivalent or better treatment performance);
- The mechanism(s) by which long-term operation and maintenance of all structural BMPs will be provided

The sizing criteria for volume-based treatment control BMPs in the LIP are as follows:

1. The volume of runoff produced from a 24-hour, 85th percentile storm event, as determined from the local historical rainfall record; or,
2. The volume of annual runoff produced by the 85th percentile, 24-hour rainfall event, determined as the maximized capture stormwater volume for the area, from the formula recommended in Urban Runoff Quality Management, WEF Manual of Practice No. 23/ASCE Manual of Practice No. 87 (1998); or,
3. The volume of annual runoff based on unit basin storage volume, to achieve 90 percent or more volume treatment by the method recommended in California Stormwater Best Management Practices Handbook – Industrial/Commercial (1993); or,
4. The volume of runoff, as determined from the local historical rainfall record, that achieves approximately the same reduction in pollutant loads and flows as achieved by mitigation of the 85th percentile, 24-hour runoff event.

The sizing criteria for flow-based BMPs in the LIP are as follows:

1. The maximum flow rate of runoff produced from a rainfall intensity of 0.2 inch of rainfall per hour for each hour of a storm event; or
2. The maximum flow rate of runoff produced by the 85th percentile hourly rainfall intensity, as determined from the local historical rainfall record, multiplied by a factor of two; or
3. The maximum flow rate of runoff, as determined from the local historical rainfall record, which achieves approximately the same reduction in pollutant loads and flows as achieved by mitigation of the 85th percentile hourly rainfall intensity multiplied by a factor of two.

### **1.8.5 CDFG Code 1601/1603**

The WQMP addresses “hydrologic conditions of concern” that address instream changes in sediment transport, erosion and sedimentation, and ultimately channel stability. Thus there is a

nexus between the WQMP and the habitat and species protection programs administered by the California Department of Fish and Game (CDFG) and the U.S. Fish and Wildlife Service.

The CDFG is responsible for conserving, protecting, and managing California's fish, wildlife, and native plant resources. To meet this responsibility, the law requires the proponent of a project that may impact a river, stream, or lake to notify the CDFG before beginning the project. This includes rivers or streams that flow at least periodically or permanently through a bed or channel with banks that support fish or other aquatic life and watercourses having a surface or subsurface flow that support or have supported riparian vegetation.

Section 1603 of the Fish and Game Code requires any person who proposes a project that will substantially divert or obstruct the natural flow or substantially change the bed, channel, or bank of any river, stream, or lake or use materials from a streambed to notify the CDFG before beginning the project. Similarly, under section 1601 of the Fish and Game Code, before any State or local governmental agency or public utility begins a construction project that will: 1) divert, obstruct, or change the natural flow or the bed, channel, or bank of any river, stream, or lake; 2) use materials from a streambed; or 3) result in the disposal or deposition of debris, waste, or other material containing crumbled, flaked, or ground pavement where it can pass into any river, stream, or lake, it must first notify the CDFG of the proposed project.

If the CDFG determines that the project may adversely affect existing fish and wildlife resources, a Lake or Streambed Alteration Agreement is required.

### **1.8.6 Endangered Species**

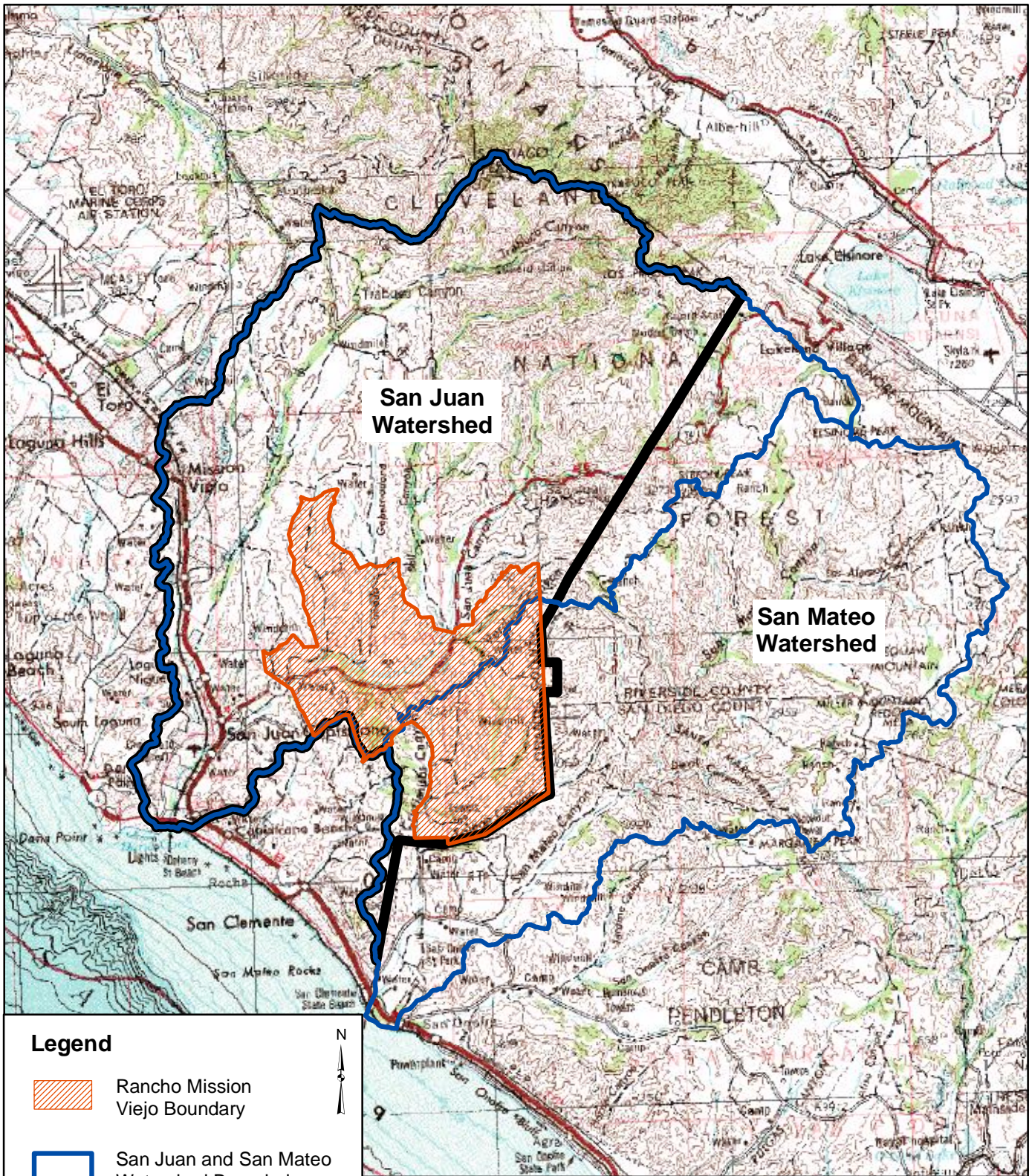
The federal Endangered Species Act (ESA) and its implementing regulations prohibit any person from harassing, harming, pursuing, hunting, shooting, wounding, killing, trapping, capturing or collecting any listed threatened or endangered species. The purpose of the ESA is to conserve the ecosystems upon which endangered and threatened species depend and to conserve and recover listed species. Endangered means a species is in danger of extinction throughout all or a significant portion of its range. Threatened means a species is likely to become endangered within the foreseeable future. The law is administered by the U.S. Fish and Wildlife for terrestrial and freshwater organisms, while the National Marine Fisheries Service has responsibility for marine species such as salmon and whales.

Section 2080 of the California Fish and Game Code prohibits "take" of any species that the Fish and Game Commission determines to be an endangered species or a threatened species. Take is defined in Section 86 of the Fish and Game Code as "hunt, pursue, catch, capture, or kill, or attempt to hunt, pursue, catch, capture, or kill."

As reviewed below, the NCCP/HCP and SAMP/MSAA programs focus heavily on listed species and their associated habitats, as well as other sensitive species and associated habitats. As reviewed earlier in this Chapter, the WQMP is a management plan that is intended to address the






protection, restoration and long-term management of water flows from future urbanized areas that may affect species and habitats addressed by the NCCP/HCP and SAMP/MSAA.

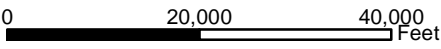


San Juan Watershed

San Mateo Watershed

**Legend**

-  Rancho Mission Viejo Boundary
-  San Juan and San Mateo Watershed Boundaries
-  Study Area

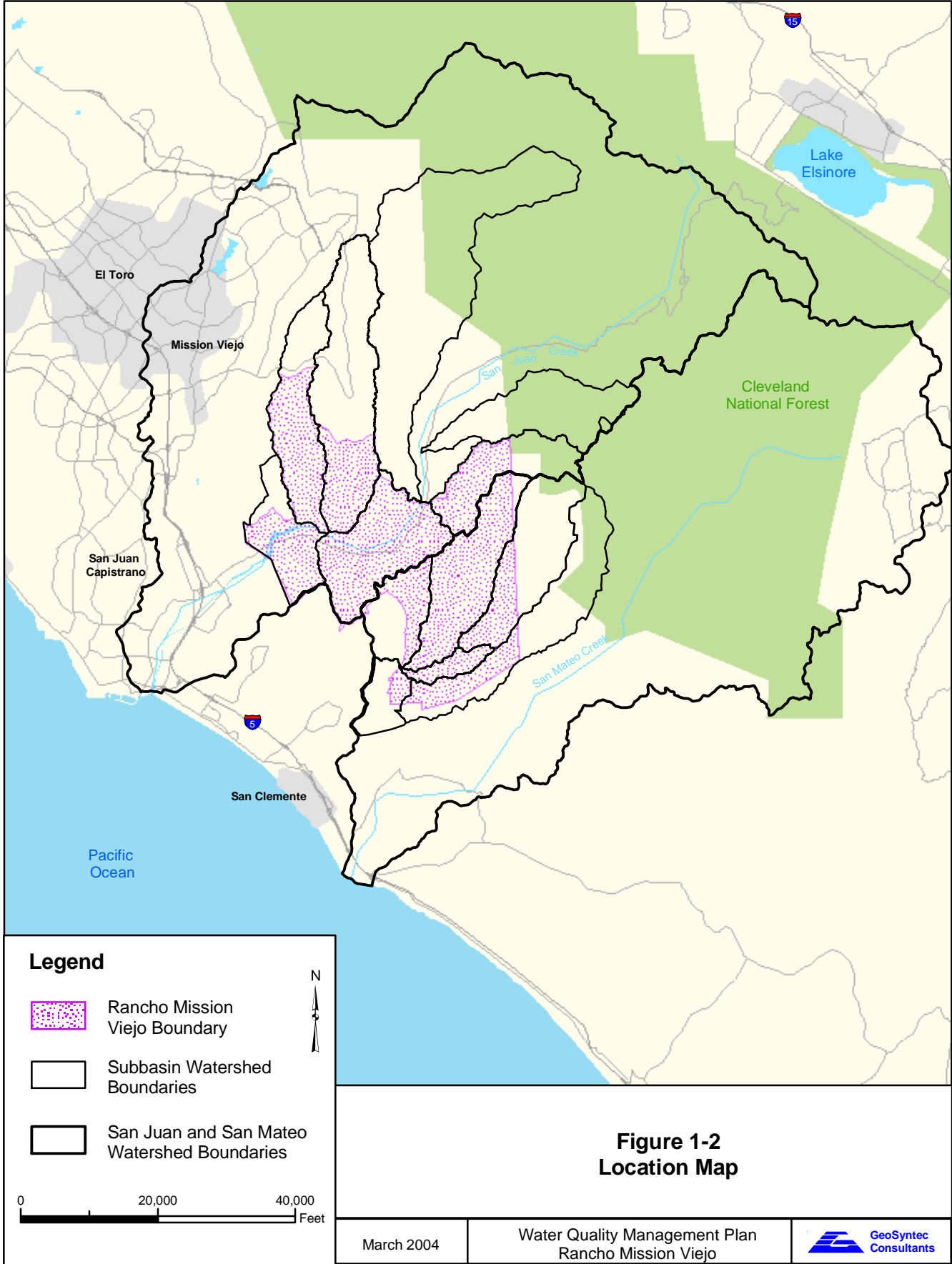


**Figure 1-1  
Southern NCCP/HCP and SAMP/MSAA  
Planning Areas**




June 2004

Water Quality Management Plan  
Rancho Mission Viejo





**Legend**

-  Rancho Mission Viejo Boundary
-  Subbasin Watershed Boundaries
-  San Juan and San Mateo Watershed Boundaries

0 20,000 40,000 Feet



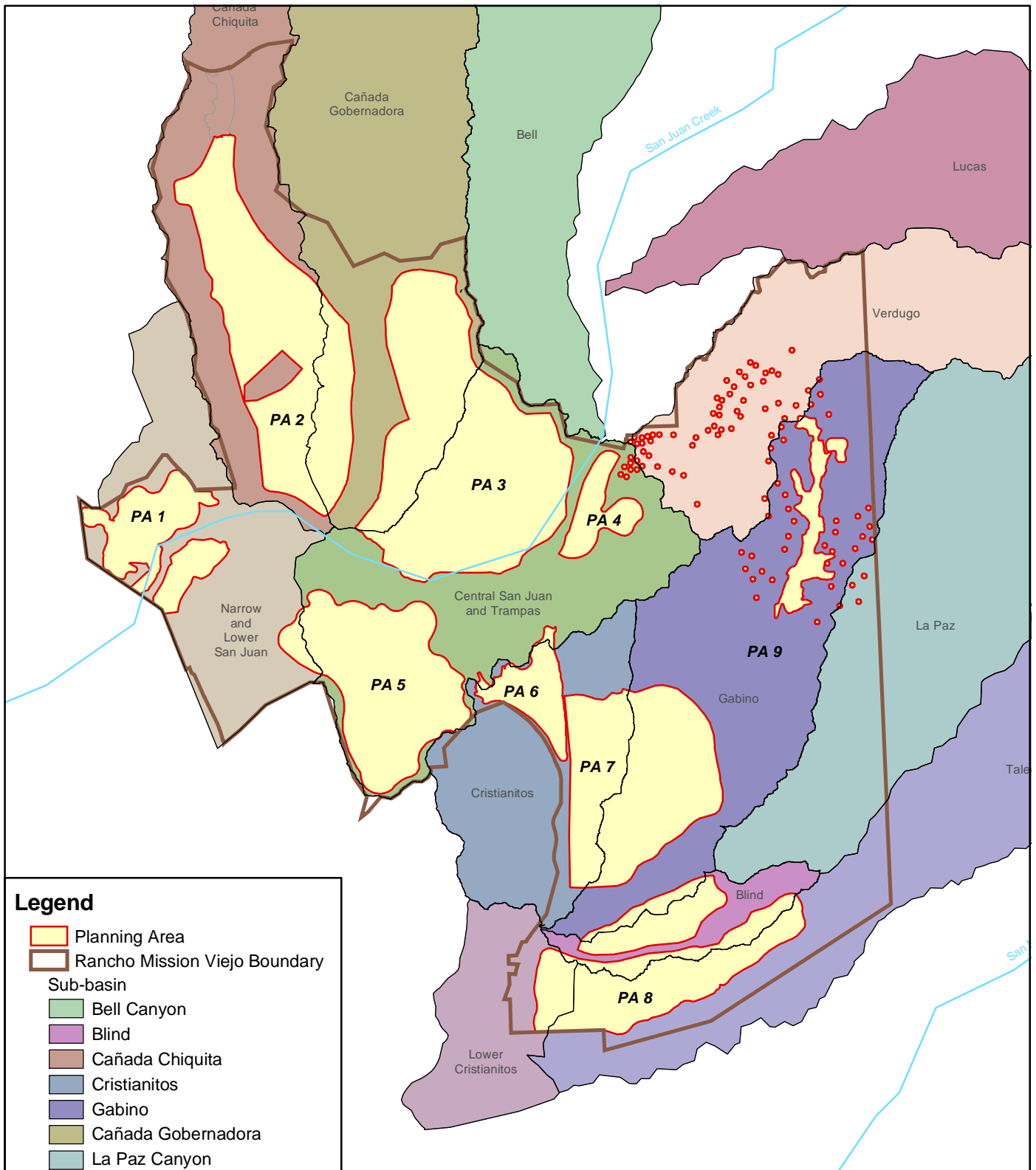
**Figure 1-2  
Location Map**

March 2004

Water Quality Management Plan  
Rancho Mission Viejo



P:\GIS\RMV\project\WQMP\feb04\Fig1-2.mxd



**Legend**

- Planning Area
- Rancho Mission Viejo Boundary
- Sub-basin
- Bell Canyon
- Blind
- Cañada Chiquita
- Cristianitos
- Gabino
- Cañada Gobernadora
- La Paz Canyon
- Lower Cristianitos
- Lower San Juan
- Lucas Canyon
- San Juan
- Talega Canyon
- Verdugo Canyon



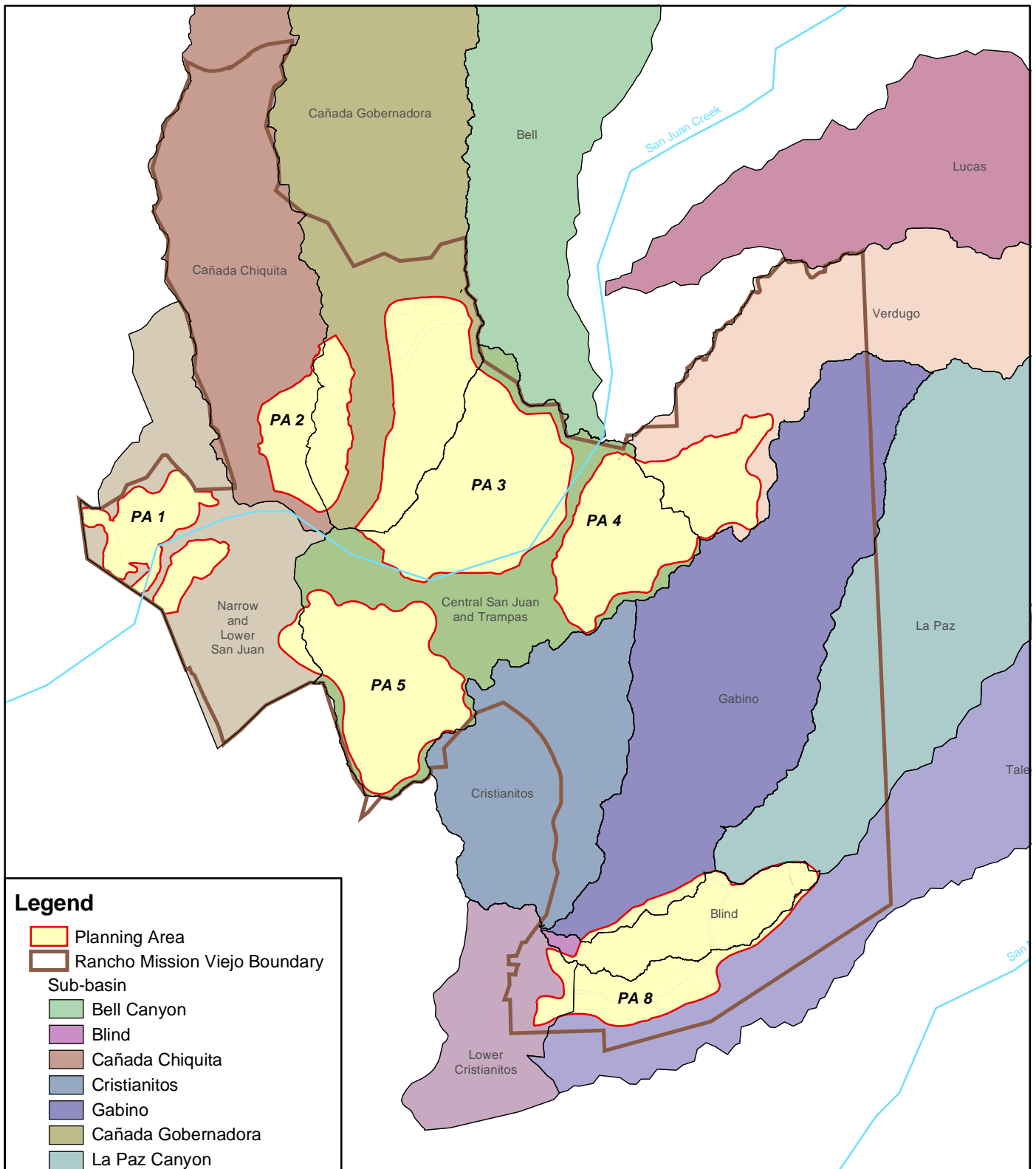
0 14,000  
 Feet

**Figure 1-3  
 Alternative B4 Planning Area Location Map**

March 2004

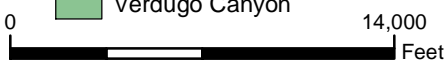
Water Quality Management Plan  
 Rancho Mission Viejo





**Legend**

- Planning Area
- Rancho Mission Viejo Boundary
- Sub-basin
- Bell Canyon
- Blind
- Cañada Chiquita
- Cristianitos
- Gabino
- Cañada Gobernadora
- La Paz Canyon
- Lower Cristianitos
- Lower San Juan
- Lucas Canyon
- San Juan
- Talega Canyon
- Verdugo Canyon

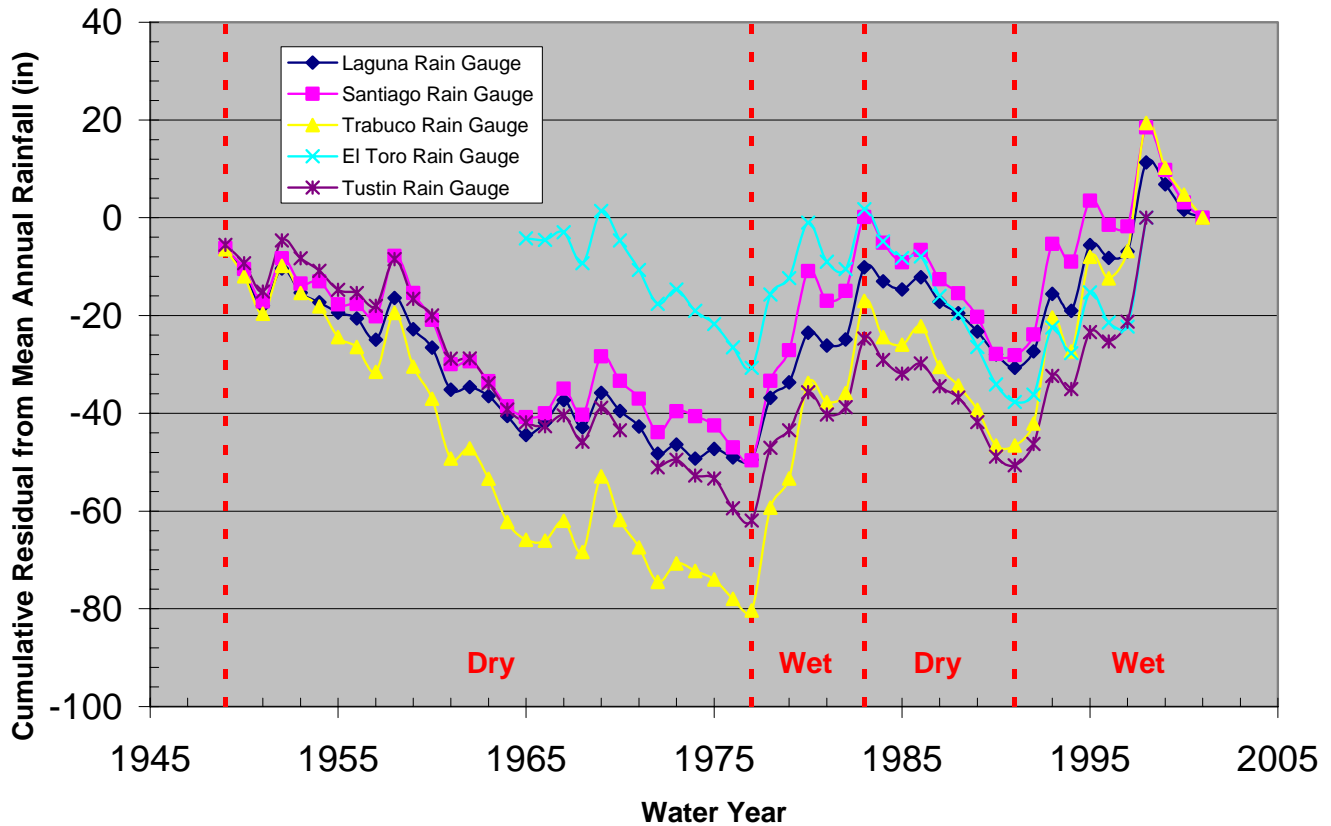


**Figure 1-4  
Alternative B9 Planning Area Location Map**

March 2004

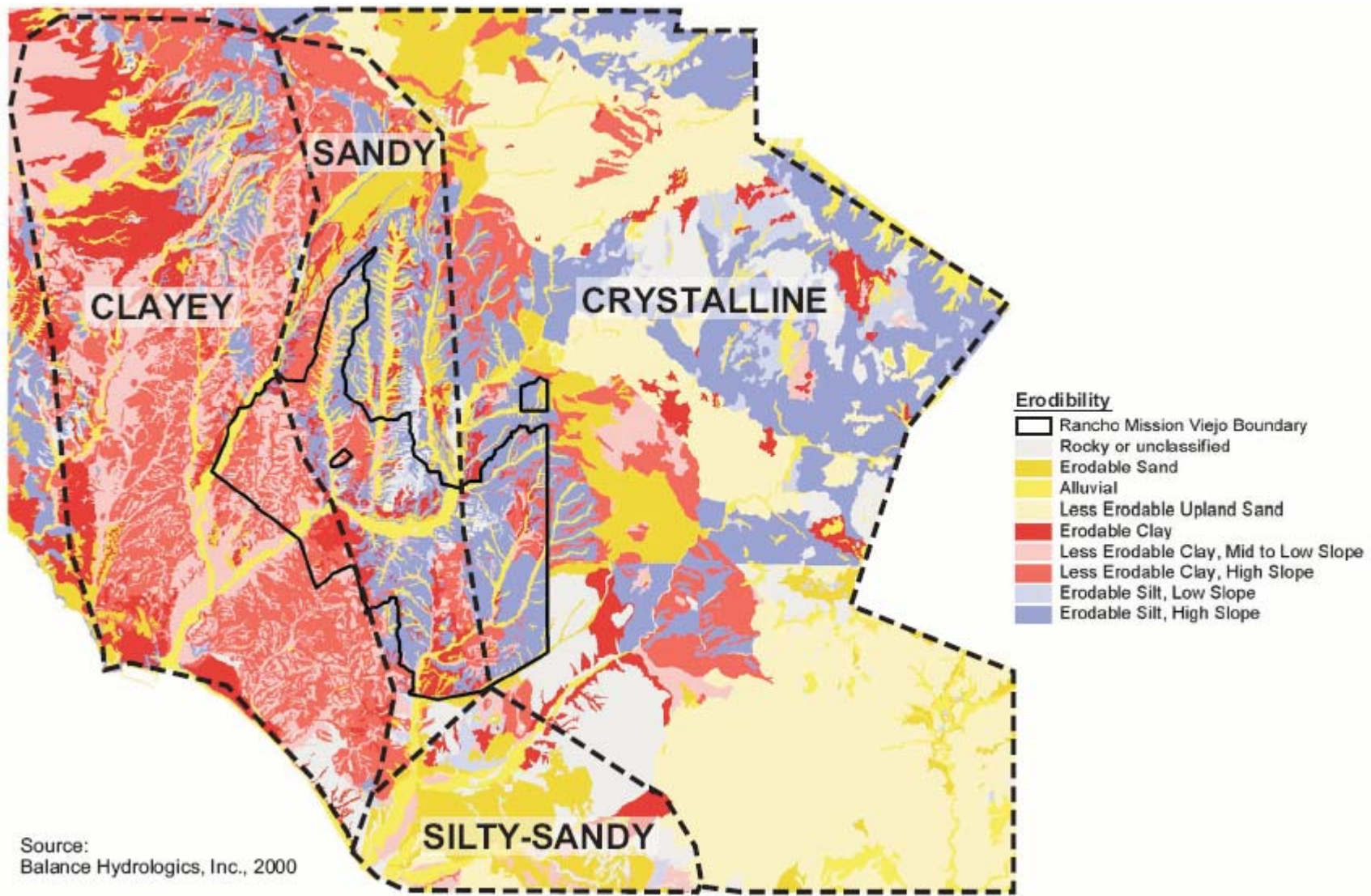
Water Quality Management Plan  
Rancho Mission Viejo



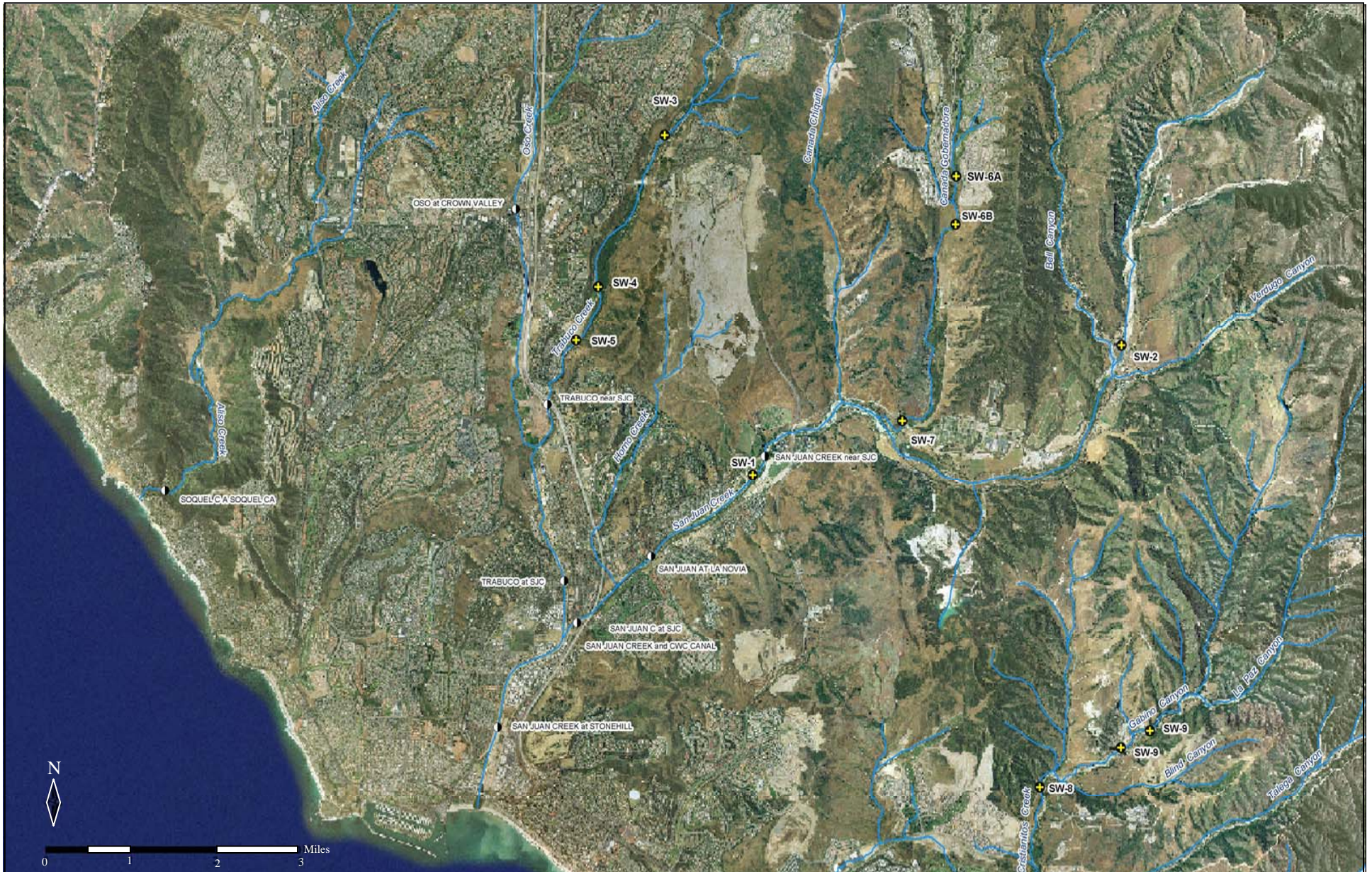


Rain Gauge	Elevation (ft)	Mean annual rainfall (inches/ Water Year)	Median annual rainfall (inches/ Water Year)
Laguna	210	12.36	10.15
Santiago	855	14.43	11.86
Trabuco	970	18.68	15.02
El Toro	445	15.64	12.17
Tustin-Irvine	118	12.99	10.44

**Figure 1-5**  
**Rainfall Wet and Dry Cycles**



**Figure 1- 6  
Geomorphologic Terrains Map**



**Figure 1-7  
Stream Monitoring Locations**

March 2004

Water Quality Management Plan  
Rancho Mission Viejo





## **2 POLLUTANTS OF CONCERN AND HYDROLOGIC CONDITIONS OF CONCERN FOR THE SAN MATEO AND SAN JUAN WATERSHEDS**

### **2.1 OVERVIEW**

Urbanization of a watershed can result in environmental stressors which may have adverse effects on ecosystem characteristics such as vegetation communities and species. Environmental stressors which are adverse can generally be described as:

- Altered hydrology due to urban development or public works projects with the potential to impact species and habitats;
- Altered geomorphic processes with the potential to impact species and habitats; and
- Pollutants generated by urban development with the potential to impact species and habitats.

The potential effects of these environmental stressors are described below.

#### **2.1.1 Potential Effects of Development on Streamcourse Hydrologic and Geomorphic Processes**

Urbanization of a watershed can profoundly change the physical characteristics of streams, harming stream habitat and beneficial uses. Urbanization is defined as the transformation of land into residential, commercial, and industrial properties and associated infrastructure such as drainages, roads, and sewers.

Urbanization modifies vegetation and soil characteristics, introduces pavement and buildings (impervious surfaces), and creates drainage and flood control infrastructure. These changes affect hydrologic processes of a watershed – the extent to which rain is intercepted by vegetation, infiltrates into the ground, or results in stormwater runoff, and the rate and magnitude of stream flows.

As the area of impervious surfaces increases, infiltration of rainfall decreases, causing more water to run off the surface as overland flow (stormwater runoff), and decreasing the time between when the rainfall occurs and when the runoff occurs. Since runoff ultimately discharges into streams (and other water bodies), increases in the volume and rate of runoff increase the frequency and duration of stream flows. This effect is more pronounced for smaller storms than for the large storms responsible for flooding.

Longer periods of increased stream flows intensify sediment transport, causing excessive erosion and modifying the geomorphology (width, depth, and slope) of stream channels. Larger peak flows and volumes and intensified stream erosion also impair the habitat in stream channels.

### **2.1.2 Potential Effects of Post-Development Surface and Subsurface Water Flows on Riparian Habitat**

The magnitudes, frequencies, and patterns of surface flow through uplands and within stream channels are the most deterministic factor of the integrity and distribution of wetlands and riparian habitat (PCR et al, 2002). Changes in the magnitude or frequency of peak flows for moderate events (i.e., 2 year), channel-forming events (i.e., 5-year or 10-year return interval), or extreme events (i.e., 25 year, 50-year, or 100-year return interval) can affect the long-term viability of riparian habitat and influence the type of community that persists. Increased frequency of high flows (resulting from increased runoff) can destabilize channels and encourage invasion by aggressive non-native plant species. Changes in base flow can change the physical and biological structure of the stream. Habitat for sensitive species may also be affected by changes in the physical, chemical, or biological condition of the stream that results from alteration of surface water hydrology.

Persistent base flows throughout the normal dry season due to irrigation runoff or discharges from sewage treatment plants can cause changes in vegetation by encouraging the growth of riparian species, some native and some introduced (Wetlands Research Associates, 2002). This growth not only stabilizes the banks, but may also deepen channels beyond a depth suitable for breeding pools for species such as the southwestern arroyo toad; such vegetation growth may also shade the water, thus lowering water temperatures below the level required for southwestern arroyo toad or other aquatic species larval growth and survival.

The long-term sustainability of riparian habitats suitable for species such as the arroyo toad, least Bell's vireo and southwestern willow flycatcher depends on both frequent runoff events and episodic geomorphic disturbance (PCR and Dudek, 2002). Early successional habitats, important for breeding, are created by small, frequent flooding within adjacent terraces and ideally contain a dense shrub layer. Periodic overbank flooding facilitates development of riparian habitat by depositing sediment, dispersing seeds, re-hydrating floodplain soils, and flushing accumulations of salts.

### **2.1.3 Potential Effects of Development on Pollutants**

Pollutants are carried from urbanized areas to receiving waters in stormwater and dry weather runoff. As water washes over the land, whether it comes from rain, car washing, or the watering of lawns, it intercepts and picks up an array of contaminants that it encounters along the way. These contaminants include a wide variety of material, such as oil, sediment, litter, bacteria, nutrients, toxic materials, and general debris from urban and suburban areas. Construction can be a major source of sediment erosion. Petroleum hydrocarbons result mostly from automobile sources. Nutrient and bacterial contaminants include garden fertilizers, yard waste, and animal waste. Impervious surfaces also may adsorb solar radiation, act as a heat source, and increase the temperature of runoff. As populations increase, the potential for increase in pollutant

loadings in runoff also increases, and if left untreated, these pollutant loadings will eventually find their way into waterways, either directly or through constructed storm drains.

#### **2.1.4 WQMP Approach to Addressing Potential Impacts of Stressors**

This Conceptual WQMP addresses four broad categories of potential “stressors” potentially impacting habitats and species:

- Altered hydrology due to urban development or public works projects with the potential to impact species and habitats;
- Altered geomorphic processes with the potential to impact species and habitats;
- Pollutants generated by urban development with the potential to impact species and habitats; and
- Elevated temperatures with the potential to impact species and habitats.

The Local WQMP guidance address each of these categories of stressors, and provide a framework for identifying pollutants and hydrologic conditions of concern, pollutant sources, and guidance on selection of suitable site design, source controls, and treatment controls for addressing pollutants of concern. The Local WQMP also provides specific guidance on the applicability of treatment controls that could affect groundwater quality, and the conditions under which controls that rely on infiltration will be permitted. Those conditions include requirements on minimum depth to high seasonal groundwater table, limitations on infiltrating dry weather flows, and other requirements that are addressed in Section 3.5.2 Groundwater Impacts.

Similarly the SAMP Tenets and Baseline Conditions Watershed Planning Principles set forth in the *Watershed and Sub-basin Planning Principles* provide policy direction for addressing each of the above stressors.

The SAMP Tenets policies include:

- Protect headwaters
- Maintain and/or restore floodplain connection
- Maintain and/or restore sediment sources and transport equilibrium

The Watershed Planning Principles address the stressors (Altered Hydrology is sub-divided into Changes in Surface Water Hydrology and Changes in Groundwater Hydrology) under the following sets of principles. For each set of Watershed Principles, a summary of the WQMP approach addressing the Principle(s) is provided.

## ***Pollutants***

The Baseline Conditions Watershed Planning Principles Section “v) Water Quality” sets forth the following principle for water quality/pollutants:

- Principle 9 – Protect water quality by using a variety of strategies, with particular emphasis on natural treatment systems such as water quality wetlands, swales and infiltration areas and application of Best Management Practices within development areas to assure comprehensive water quality treatment prior to the discharge of urban runoff into the Habitat Reserve.

The WQMP approach to address this principle is to incorporate into the stormwater system a mix of site design, source control, and treatment control BMPs, pursuant to the Orange County Local WQMP, that will be protective of both surface and groundwater quality. These BMPs include the use of natural treatment systems such as bioswales and wetlands, extended detention basins, infiltration, cisterns, and provisions for utilizing stormwater for irrigating common area landscaping and golf courses. Potential changes in pollutants of concern are addressed based on runoff water quality modeling, literature information, and professional judgment. The level of significance of impacts is evaluated based on significance criteria that include predicted runoff quality for proposed versus existing water quality and quantity conditions, water quality standards, MS4 Permit requirements, and effects on NCCP/HCP “planning species”.

## ***Changes in Surface Water Hydrology***

Baseline Conditions Watershed Planning Principles Section “ii) Hydrology” sets forth the following planning principles for surface water hydrology:

- Principle 2 – Emulate, to the extent feasible, the existing runoff and infiltration patterns in consideration of specific terrains, soil types, and ground cover.
- Principle 3 – Address potential effects of future land use changes on hydrology.
- Principle 4 – Minimize alterations of the timing of peak flows of each sub-basin relative to the mainstem creeks.
- Principle 5 – Maintain and/or restore the inherent geomorphic structure of major tributaries and their floodplains.

The WQMP approach to address this principle is to incorporate all of these hydrologic planning principles into the design of the stormwater system. Hydrologic modeling techniques were implemented to estimate the pre-developed runoff flow rates and volumes considering existing terrains, soil types, and ground covers. Detention and infiltration BMPs were then sized accordingly to match, to the extent feasible, post-development hydrologic conditions to the pre-developed conditions at the development bubble, catchment, and sub-basin levels. Hydrologic

conditions were matched for monthly water balances and flow versus duration for a continuous segment of the precipitation record. The modeling techniques employed considered the role of longer-term wet/dry cycles and how such cycles influence hydrologic conditions. A detailed description of the models employed is included in Appendix A.

### ***Changes in Groundwater Hydrology***

Baseline Conditions Watershed Planning Principles Section “iv) Groundwater Hydrology” sets forth the following principles:

- Principle 7 – Utilize infiltration properties of sandy terrains for groundwater recharge and to off-set potential increases in surface runoff and adverse effects to water quality.
- Principle 8 – Protect existing groundwater recharge areas supporting slope wetlands and riparian zones; and maximize groundwater recharge of alluvial aquifers to the extent consistent with aquifer capacity and habitat management goals.

To replicate (or emulate to the maximum extent practicable) pre-development infiltration and to protect groundwater quality, flow and water quality control facilities that incorporate infiltration will be located in the head end of side canyons where depth to groundwater is greatest. Extended detention also will provide pre-treatment to the infiltrated water to minimize impacts to groundwater quality. Additional treatment will occur through natural soils processes as infiltrated water moves through soils into the groundwater system.

### ***Changes in Geomorphic Processes***

Baseline Conditions Watershed Planning Principles Section “i) Geomorphology/Terrains” sets forth the following principle:

- Principle 1 – Recognize and account for the hydrologic response of different terrains at the sub-basin and watershed scale.

Land use planning should strive to mimic the hydrologic response of existing terrains by primarily locating development in areas which have low infiltrative soils, such as the “hardpan” areas and areas of clay soils found on the ridges in Cañada Chiquita and Canada Gobernadora. Surface runoff flows have been directed to water quality treatment, detention, and infiltration BMPs located in the permeable substrate of the major side canyons and along the valley floor. Setbacks from the mainstem creek channels are incorporated through a variety of means, including proposed Habitat Reserve areas and water quality buffer strips.

Baseline Conditions Watershed Planning Principles Section “i) Geomorphology/Terrains” and “iii) Sediment Sources, Storage, and Transport” sets forth the following principle:

- Principle 6 – Maintain coarse sediment yields, storage and transport processes.

The WQMP approach to address this principle is to design water quality and flow control facilities “offline” of the storm drainage and flood control system, so that large flows and attendant sediment loads will bypass the water quality facilities. The WQMP facilities will be designed to capture primarily fine sediments that contain the majority of pollutant mass and which cause adverse effects to aquatic species and habitats through increased turbidity and settlement in breeding habitats. Matching post-development flow durations to pre-development flow durations in the flow control facilities will help ensure that the pre-development transport processes in the mainstem channels are preserved.

As noted previously, each of the above Principles includes specific policies providing more specific guidance for maintaining net habitat value at a watershed scale. Further, the sub-basin “Planning Considerations” and “Planning Recommendations” set forth in the draft Watershed and Sub-Basin Planning Principles provide geographic-specific planning and resource protection guidance for each sub-basin within the 22,815 acres of RMV lands that are the subject of this WQMP. Accordingly, the WQMP addresses both the overall principles set forth in the Baseline Conditions Watershed Principles and the specific Planning Considerations and Planning Recommendations for each sub-basin set forth in the draft Watershed and Sub-Basin Planning Principles document.

The WQMP addresses the above principles within the water quality management framework established by the County of Orange and the San Diego Regional Water Quality Control Board (SDRWQCB). The County and the SDRWQCB require that potential development impacts are to be analyzed under two broad headings: (1) Hydrologic Conditions of Concern, and (2) Pollutants of Concern.

## **2.2 HYDROLOGIC CONDITIONS OF CONCERN**

Hydrologic Conditions of Concern are addressed in the Conceptual WQMP in accordance with the following methodology established in the Local WQMP:

1. Determine whether a downstream stream channel is fully natural or partially improved with a potential for erosive conditions or alteration of habitat integrity to occur as a result of upstream development.
2. Evaluate the project’s conditions of concern considering the project area’s location (from the larger watershed perspective), topography, soil and vegetation conditions, percent impervious area, natural and infrastructure drainage features, and other relevant hydrologic and environmental factors to be protected specific to the project area’s watershed.
3. Review watershed plans, drainage area master plans or other planning documents to the extent available for identification of specific implementation requirements that address hydrologic conditions of concern.

4. Conduct a field reconnaissance to observe and report on representative downstream conditions, including undercutting erosion, slope stability, vegetative stress (due to flooding, erosion, water quality degradation, or loss of water supplies) and the area's susceptibility to erosion or habitat alteration as a result of an altered flow regime or change in sediment transport.
5. Compute rainfall runoff characteristics from the project area including peak flow rate, flow velocity, runoff volume, time of concentration, and retention volume.
6. A drainage study report must be prepared identifying the project's conditions of concern based on the hydrologic and downstream conditions discussed above. Where downstream conditions of concern have been identified, the drainage study shall establish that pre-project hydrologic conditions affecting downstream conditions of concern would be maintained by the proposed project by incorporating the site design, source control, and treatment control requirements identified in the County/SD RWQCB Model Water Quality Management Plan. For conditions where a reduction in sediment transport from the project development and features would significantly impact downstream erosion, the Treatment Control BMPs proposed should be evaluated to determine if use of the BMPs would result in reducing beneficial sediment (i.e. sand and gravel) significantly below pre-development levels. Under such conditions alternative BMPs (such as watershed based approaches for erosional sediment control) may need to be considered.

The WQMP includes sections documenting the consistency of the WQMP both with the above County/SD RWQCB requirements and with applicable principles of the Watershed Planning Principles. In particular, the WQMP analysis of the Hydrologic Conditions of Concern specifically analyzes hydrologic conditions set forth in the Watershed Planning Principles for the purpose of maintaining net habitat value with regard to: (1) potential increases in dry season stream base flow and wet season base flow between storms; (2) changes in the magnitude, frequency, and duration of annually expected flow events (typically 1-2 year events); (3) changes in hydrologic response to major episodic storm events; (4) potential changes in sediment supply, with short term reductions related to impervious/landscaped ground cover; and (5) potential changes in the infiltration of surface/soil water to groundwater.

For the Cañada Gobernadora Sub-basin, the sub-basin exhibiting existing conditions stressors due to prior upstream development in Coto de Caza, specific performance criteria for implementation of the Gobernadora Multipurpose Basin have been prepared to complement Gobernadora Sub-basin water management measures set forth in the WQMP and thereby increase net habitat value.

### **2.3 POLLUTANTS OF CONCERN**

The pollutants of concern for the water quality analysis are those pollutants that are anticipated or potentially could be generated by the Project, based on the proposed land uses and past land uses, that have been identified by regulatory agencies as potentially impairing beneficial uses in

the receiving water bodies or that could adversely affect receiving water quality or endangered species.

Primary pollutants of concern are those which have been identified as causing impairment of receiving waters. Pathogens (bacteria indicators) have been identified on the 303(d) list as impairing the beneficial uses in Lower San Juan Creek and are therefore a primary pollutant of concern.

Other pollutants of concern addressed in the Conceptual WQMP include:

- Sediment (Total Suspended Solids)
- Nutrients (Ammonia, Nitrate, and Total Phosphorus)
- Trace Metals (Aluminum, Cadmium, Copper, Lead, and Zinc)
- Hydrocarbons (Oil and Grease, Polycyclic Aromatic Hydrocarbons)
- Pesticides
- Trash and Debris

The Local WQMP includes two additional categories of pollutants of concern – organic compounds and oxygen-demanding compounds. The pollutants in these two categories are also included in the categories above. For example, typical organic compounds in urban runoff include pesticides, petroleum hydrocarbons, and vegetative debris. Oxygen-demanding substances typical in urban stormwater runoff are included in trash and debris, such as biodegradable food and vegetation waste. Chemical oxygen-demanding compounds, such as ammonia, are included in the nutrient category.

Appropriate regulatory standards, including special standards applicable to species pursuant to the California Toxics Rule, have been applied in formulating the Conceptual WQMP BMPs and in addressing the Water Quality principles set forth in the *Watershed and Sub-basin Planning Principles*.

### **2.3.1 Pathogens**

Urban runoff typically contains elevated levels of pathogenic organisms. The presence of pathogens in runoff may result in waterbody impairments such as closed beaches, contaminated drinking water sources, and shellfish bed closings. The proliferation of pathogens is typically caused by the transport of animal or human fecal wastes from the watershed. Total and fecal coliform, Enterococcus bacteria, and E. coli bacteria (strains of which are pathogenic) are commonly used as an indicator for pathogens due to the difficulty of monitoring for pathogens directly.



### **2.3.2 Sediment**

Excessive erosion, transport, and deposition of sediment in surface waters is a significant form of pollution resulting in major water quality problems. Excessive stream erosion and sediment transport can be caused by increases in runoff volumes and peak flow rates and is discussed below. Excessive fine sediment carried in urban runoff, measured as total suspended solids, can impair aquatic life by filling interstitial spaces of spawning gravels, impairing fish food sources, filling rearing pools, and reducing beneficial habitat structure in stream channels. By contrast, coarse sediments are a critical component of the hydrologic regime and riparian habitat and measures must be undertaken to maintain conditions supporting the generation and transport of these sediments.

### **2.3.3 Nutrients**

Nutrients are inorganic forms of nitrogen and phosphorus. There are several sources of nutrients in urban areas, mainly fertilizers in runoff from lawns, pet wastes, failing septic systems, and atmospheric deposition from industry and automobile emissions. Nutrient over-enrichment is especially prevalent in agricultural areas where manure and fertilizer inputs to crops significantly contribute to nitrogen and phosphorus levels in streams and other receiving waters.

Eutrophication due to excessive nutrient input can lead to changes in periphyton, benthic, and fish communities; extreme eutrophication can cause hypoxia or anoxia, resulting in fish kills. Surface algal scum, water discoloration, and the release of toxins from sediment can also occur.

### **2.3.4 Trace Metals**

The primary sources of trace metals in stormwater are typically commercially available metals used in transportation, buildings, and infrastructure. Metals of concern include cadmium, chromium, copper, lead, mercury, and zinc. Metals are also found in fuels, adhesives, paints, and other coatings. Metals are of concern because of toxic effects on aquatic life and the potential for ground water contamination. Copper, lead, and zinc are the most prevalent metals found in urban runoff. High metal concentrations can bioconcentrate in fish and shellfish and affect beneficial uses of a waterbody.

### **2.3.5 Petroleum Hydrocarbons/Oil and Grease**

The sources of oil, grease, and other petroleum hydrocarbons in urban areas include spillage fuels and lubricants, discharge of domestic and industrial wastes, atmospheric deposition, and runoff. Runoff can be contaminated by leachate from asphalt roads, wearing of tires, and deposition from automobile exhaust. Also, do-it-yourself auto mechanics may dump used oil and other automobile-related fluids directly into storm drains. Petroleum hydrocarbons, such as polycyclic aromatic hydrocarbons (PAHs), can accumulate in aquatic organisms from contaminated water, sediments, and food and are toxic to aquatic life at low concentrations. Hydrocarbons can persist in sediments for long periods of time and result in adverse impacts on the diversity and abundance of benthic communities. Hydrocarbons can be measured as total

petroleum hydrocarbons (TPH), oil and grease, or as individual groups of hydrocarbons, such as PAHs.

### **2.3.6 Pesticides**

Pesticides (including herbicides) are chemical compounds commonly used to control insects, rodents, plant diseases, and weeds. Excessive application of a pesticide may result in runoff containing toxic levels of its active component. Pesticides are of particular concern with respect to the protection and restoration of endangered aquatic and terrestrial species (Wetland Research Associates, 2002)

### **2.3.7 Trash & Debris**

Trash (such as paper, plastic, polystyrene packing foam, and aluminum materials) and biodegradable organic matter (such as leaves, grass cuttings, and food waste) are general waste products on the landscape. The presence of trash & debris may have a significant impact on the recreational value of a water body and aquatic habitat. Excess organic matter can create a high biochemical oxygen demand in a stream and thereby lower its water quality. Also, in areas where stagnant water exists, the presence of excess organic matter can promote septic conditions resulting in the growth of undesirable organisms and the release of odorous and hazardous compounds such as hydrogen sulfide.

## **2.4 THRESHOLDS OF SIGNIFICANCE**

Thresholds of significance for hydrology and water quality have been developed by Orange County Planning Department for the proposed development alternatives. Significant water resources impacts are presumed to occur if the proposed alternative would:

- Substantially increase the rate or amount of surface runoff in a manner that would expose people or structures to onsite or offsite flooding or result in peak runoff rates from the site that would exceed existing or planned capacities of downstream flood control systems.
- Substantially increase or decrease low flow estimates where high groundwater elevations are considered important.
- Substantially alter the existing drainage pattern of the site or area, including alteration of the course of a stream or river, in a manner that would cause substantial erosion or siltation.
- Substantially increase the frequencies and duration of channel adjusting flows.
- Substantially deplete groundwater supplies or interfere substantially with groundwater recharge that would cause a net deficit in aquifer volumes or lowering of the local groundwater table.

- Violate surface and/or ground water quality standards or waste discharge requirements for the receiving drainages, including applicable provisions of:
  - County of Orange SUSMP
  - California Toxics Rule for metals
  - RWQCB Standards
- Expose people or structures to a significant risk of loss, injury or death involving flooding, including flooding as a result of the failure of a levee or dam, or inundation by seiche, tsunami, or mudflow.
- Require the construction of new storm water drainage facilities or expansion of existing facilities where the construction would cause significant environmental effects.
- Conflict with any applicable plan, policy or regulation of an agency with jurisdiction over the project adopted for the purpose of avoiding or mitigating an environmental effect related to hydrology or water quality.
- Conflict with applicable San Juan Creek Watershed/Western San Mateo Creek Watershed SAMP/MSAA Planning Principles

For convenience, the specific thresholds identified above are provided in the following subsections. Significance thresholds listed above that related to flooding impacts have not been included and are addressed in a separate report, titled: Alternatives Analysis: Hydrologic Comparison of Baseline and Alternative Land Use Conditions for San Juan and San Mateo Watersheds (PWA, 2004).

#### **2.4.1 Significance Thresholds for Hydrologic Conditions of Concern Set Forth in the County of Orange LIP**

Table 2-1 summarizes the hydrologic conditions of concern and significance thresholds set forth in the LIP.

**Table 2-1: Hydrologic Condition of Concern and Significance Thresholds**

Hydrologic Conditions of Concern	Significance Threshold
1. Increased Stormwater Runoff Flow Rate, Volume, and Flow Duration	<ul style="list-style-type: none"> <li>A. Substantially alter the existing drainage pattern of the site or area, including alteration of the course of a stream or river, in a manner that would cause substantial erosion or siltation.</li> <li>B. Substantially increase the frequencies and duration of channel adjusting flows.</li> </ul>
2. Decreased Infiltration and Groundwater Recharge	<ul style="list-style-type: none"> <li>A. Substantially deplete groundwater supplies or interfere substantially with groundwater recharge that would cause a net deficit in aquifer volumes or lowering of the local groundwater table.</li> </ul>
3. Changed Base flow	<ul style="list-style-type: none"> <li>A. Substantially increase or decrease base flows as to negatively impact riparian habitat.</li> <li>B. Substantially increase or decrease low flow estimates where high groundwater elevations are considered important.</li> </ul>

**2.4.2 Significance Thresholds for Pollutants of Concern**

The significance thresholds for pollutants of concern are the narrative and numeric surface and groundwater quality objectives and criteria in the Basin Plan and the CTR. As discussed earlier the State’s Implementation Plan for the CTR criteria do not apply to stormwater discharges; nonetheless, the criteria do provide a basis for comparison and one means of evaluating the potential effects of discharges of pollutants on aquatic toxicity.

Surface water quality criteria in the CTR are presented as both acute criteria and chronic criteria. Based on rainfall analyses of local rain gauges, the average duration of rainfall events in the Project area is 11.6 hours (Appendix A). This duration is representative of an acute rather than a chronic exposure. Acute criteria represent the highest concentration of a pollutant to which aquatic life can be exposed for a short period of time (one hour) without deleterious effects; chronic criteria equal the highest concentration to which aquatic life can be exposed for an extended period of time (four days) without deleterious effects. Chronic criteria are applicable to base flow conditions.

As there is no water quality objective or criteria for total aluminum in the San Diego Basin Plan or the CTR, the national water quality criteria recommended by the USEPA will be used for comparison (USEPA, 2002b).

Water quality criteria do not apply directly to discharges of stormwater runoff. Nonetheless, water quality criteria can provide a useful means to assess the potential for project discharges to affect the water quality of receiving waters. In this document, the water quality criteria are used as a comparative measure to evaluate potential ecological impacts.

The only pollutant of concern with a water quality objective for groundwater in the proposed development’s hydrologic unit (the San Juan Hydrologic Unit) in the San Diego Basin Plan is nitrate-nitrogen. The Basin Plan objective for nitrate in groundwater is 10 mg/L as N.

Pollutants of concern and significance thresholds for surface water are summarized in Table 2-2.

**Table 2-2: Pollutants of Concern and Significance Thresholds for Surface Water**

Pollutants of Concern	Significance Thresholds
Sediment: Total Suspended Solids (TSS)	<ol style="list-style-type: none"> <li>Narrative objective in the Basin Plan<sup>1</sup>: “The suspended sediment load and suspended sediment discharge rate of surface waters shall not be altered in such a manner as to cause nuisance or adversely affect beneficial uses.”</li> </ol>
Nutrients: Nitrate Nitrogen, Total Kjeldahl Nitrogen, and Total Phosphorus	<ol style="list-style-type: none"> <li>Narrative objective in the Basin Plan: “Concentrations of nitrogen and phosphorus, by themselves or in combination with other nutrients, shall be maintained at levels below those which stimulate algae and emergent plant growth.”</li> <li>Basin Plan objective: “A desired goal in order to prevent plant nuisances in streams and other flowing waters appears to be 0.1 mg/L total Phosphorus.”</li> <li>Basin Plan objective: “Analogous threshold values have not been set for nitrogen compounds; however, natural ratios of nitrogen to phosphorus are to be determined by surveillance and monitoring and upheld.”</li> </ol>
Trace metals: Aluminum, Cadmium, Copper, Lead, and Zinc	<ol style="list-style-type: none"> <li>Narrative objective in the Basin Plan: Toxic substances shall not be discharged to levels that will adversely affect beneficial uses.</li> <li>The CTR<sup>2</sup> criteria for Cd, Cu, Pb, and Zn are the applicable water quality objectives for protection of aquatic life. The CTR criteria are expressed for acute and chronic (4-day average) conditions; however, only acute conditions are applicable for stormwater discharges because the duration of stormwater discharge is typically less than 4 days.</li> <li>CTR criteria for Cd, Cu, Pb, and Zn are expressed for dissolved metal concentrations and are determined on the basis of hardness in the receiving water. In application of criteria to the Project, local hardness data will be used to determine most appropriate criteria.</li> <li>EPA’s national recommended acute water quality criterion (NAWQC)<sup>3</sup> for total aluminum is 750 µg/L within the pH range of 6.5 to 9.0.</li> </ol>

Pollutants of Concern	Significance Thresholds
Pathogens (Fecal Coliform, Viruses, and Protozoa)	<ol style="list-style-type: none"> <li>1. Basin Plan objectives are based on the designated uses of the water body. The most restrictive designation for the Project's receiving waters is Primary Contact Recreation. The Basin Plan water quality objective for this use designation is, for not less than 5 samples for any 30-day period, fecal coliform shall not exceed a log mean of 200 MPN/100 mL, nor shall more than 10% of total samples during any 30-day period exceed 400 MPN/100mL.</li> </ol>
Petroleum Hydrocarbons: Oil & Grease and Polycyclic Aromatic Hydrocarbons (PAHs)	<ol style="list-style-type: none"> <li>1. CTR objectives are available for some organic compounds.</li> <li>2. PAHs are a class of compounds. CTR values for individual PAHs are available for protection of human health only. There are no regulatory standards for the protection of aquatic health.</li> <li>3. Narrative objective in the Basin Plan for oil &amp; grease: "Waters shall not contain oils, greases, waxes, or other materials in concentrations which result in a visible film or coating on the surface of the water, or which cause nuisances or which otherwise adversely affect beneficial uses."</li> </ol>
Pesticides	<ol style="list-style-type: none"> <li>1. Narrative objective in the Basin Plan: Toxic substances shall not be discharged to levels that will adversely affect beneficial uses.</li> <li>2. CTR lists numeric objectives for some, but not all pesticides. There are no CTR criteria for diazinon and chlorpyrifos.</li> </ol>
Trash and Debris	<ol style="list-style-type: none"> <li>1. Basin Plan narrative floatables objective: "Waters shall not contain floating materials, including solids, liquids, foams, and scum, in concentrations which cause nuisance or adversely affect beneficial uses."</li> </ol>

<sup>1</sup>Water Quality Control Plan for the San Diego Basin (San Diego Basin Plan) (SDRWQCB, 1994).

<sup>2</sup>U.S. Environmental Protection Agency, Federal Register, Volume 65, No. 97 (Thursday, 18 May 2000), pp. 31682-31719; and Federal Register, Volume 66, No. 30 (Tuesday 13 February 2001), pp. 9960-9962 (California Toxics Rule and Correction).

<sup>3</sup>U.S. Environmental Protection Agency, Office of Water, *National Recommended Water Quality Criteria 2002*, EPA 822-R-02-047 (November 2002).

### **2.4.3 Significance Thresholds for Compliance with Plans, Policies, Regulations, and Permits**

The following are significance thresholds associated with compliance with plans, policies, regulations, and permits applicable to hydrologic conditions of concern and pollutants of concern:

1. Violate waste discharge requirements including applicable provisions of the County of Orange SUSMP, the MS4 NPDES Permit, and MEP.
2. Construction of new storm water drainage facilities or expansion of existing facilities would cause significant environmental effects.
3. Conflict with any applicable plan, policy, or regulation of an agency with jurisdiction over the project adopted for the purpose of avoiding or mitigating an environmental effect related to hydrology or water quality.
4. Conflict with applicable San Juan Creek Watershed/Western San Mateo Creek Watershed SAMP/MSAA Planning Principles (including Corps 404(b) (1) water quality guidelines).

The first three sets of plans and policies and regulations will be addressed in Chapters 4 and 5. The Baseline Conditions Watershed Principles discussed in Section 1.2.2 provide guidance for the WQMP. The Watershed Principle Sub-Basin “Planning Considerations” and “Planning Recommendations” will be addressed within the specific chapters of the WQMP addressing specific sub-basins.

### **3 WATER QUALITY AND FLOW CONTROL CONCEPT AND ANALYSIS APPROACH**

This chapter describes the proposed concept for controlling runoff water quality and flows and the analysis approach used to evaluate the effectiveness of the control system and the effect of the proposed project on flow and water quality. With regard to nomenclature, control of pollutants is defined as “treatment control” whereas control of hydrologic effects is defined herein as “flow control”. This nomenclature differs from that in the LIP where treatment control applies to both water quality and hydrology.

#### **3.1 OVERVIEW**

Urban development affects hydrology in two important ways. First, where no urban development has previously occurred, natural vegetated pervious ground cover is converted to impervious surfaces such as paved highways, streets, rooftops, and parking lots. Natural vegetated soil can both absorb rainwater and remove pollutants, providing a very effective natural purification process. Because pavement and rooftops can neither absorb water nor remove pollutants, the natural purification characteristics of the land are lost. As a consequence of adding impervious surfaces, drainage infrastructure is introduced which more rapidly conveys runoff to receiving waters. Secondly, urban development creates new pollution sources as human population density increases and brings with it proportionately higher levels of car emissions, car maintenance wastes, fertilizers, pesticides, household hazardous wastes, pet wastes, trash, etc., which can be washed into the municipal separate storm sewer system (MS4). As a result of these two changes, the runoff leaving a newly developed urban area may be significantly greater in volume, velocity and/or pollutant load than pre-development runoff from the same area. Minimizing a development’s detrimental effects on runoff water quality and quantity can be most effectively achieved through the use of a combination of site design, source control, treatment control, and flow control Best Management Practices (BMPs).

##### **3.1.1 Hydromodification**

“Hydromodification” is the term used to refer to changes in runoff characteristics and associated stream impacts that result from land use changes. Many factors and processes interact to influence hydromodification. Figure 3-1 illustrates the hydrologic processes relevant to hydromodification. Regional factors of climate, geology, and physical geography affect the amount of runoff and sediment discharged to stream channels. Land use, soil, and vegetation characteristics affect the proportion of rainfall that infiltrates into the ground or runs off the surface. Local climate, geology, and physical geography also affect the type and amount of sediment that is supplied to the stream system. The changes in stream flow and sediment load that result from land use changes ultimately change the physical characteristics and habitat value of the stream channel.



### **3.1.2 Local WQMP – Hydrologic Conditions of Concern**

In Section A-7.VI-3.2.4 of the Local WQMP, there is a requirement to conduct a drainage study that:

*“...shall compute rainfall runoff characteristics from the project area including, at a minimum, peak flow rate, flow velocity, runoff volume, time of concentration, and retention volume. These characteristics shall be developed for the two-year and 10-year frequency, Type I storm of six-hour or 24-hour duration (whichever is the closer approximation of the site’s time of concentration), during critical hydrologic conditions for soil and vegetative cover.”*

The requirement also allows the applicant to calculate the storm events using local rain data. For the WQMP, local rain data were used to estimate runoff continuously using a 53-year record of rainfall. This analysis, as described later, takes into account the full spectrum of rainfall runoff events contained in this record, including the two-year and 10-year events called for in the Local WQMP. Advantages of the continuous modeling approach used in this WQMP include:

- Uses continuous long-term records of observed rainfall rather than short periods of data representing hypothetical storm events, thereby allowing the analysis to evaluate effects associated with wet and dry climactic cycles;
- Allows modeling to incorporate detailed information on actual site conditions;
- Allows direct examination of flow duration data for assessing the impact of development on stream erosion and morphology;
- Allows for evaluating effectiveness of control facilities taking into account antecedent conditions such as closely spaced rainfall events and soil saturation; and
- Takes into account the complete range of rainfall-runoff events contained in an approximately 53-year record, including 2 and 10 year return period events.

### **3.2 HYDROLOGIC MODELING**

The USEPA Storm Water Management Model (SWMM) was used to estimate the effects of the proposed development on the hydrologic balance. SWMM is a public domain model that is widely used for modeling hydrologic and hydraulic processes affecting runoff from urban and natural drainages. The model can simulate all aspects of the urban hydrologic cycle, including rainfall, surface and subsurface runoff, flow routing through the drainage network, storage, and treatment. The model is particularly appropriate for analyzing post-development flow duration because the model takes into account the effects of precipitation, topography, land use, soils, and vegetation on surface runoff, infiltration, evapotranspiration, and groundwater recharge.

A detailed description of the hydrologic model, data sources and values, and calibration results is provided in Appendix A.

In this application, PC-SWMM Version 4 was applied to each sub-basin to model the hydrologic response of the sub-basin under existing and proposed land use conditions, and to assess the hydrologic effectiveness of the proposed BMPs. Each sub-basin was divided into catchments to account for changes in topography, soils, and land use. For example, the Cañada Chiquita Sub-basin was divided into 18 catchments.

The model was applied in a continuous mode in which the model is driven with a continuous record of rainfall. The record extended for 53 years, from Water Year (WY) 1949 to WY 1998. The model was run for 3 periods:

- The entire 53 year period;
- a wet period of 17 years (WY 1978 - 1983 and 1991- 2001); and
- a dry period of 36 years (WY 1949 - 1977 and 1984 - 1990).

The model incorporates a continuous soil moisture accounting algorithm which requires soil properties to model infiltration and vegetation type to model evapotranspiration. Soils information was obtained from the US Department of Agriculture Soil Survey of Orange County and Western Part of Riverside County, California (1978) and also the hardpan areas mapped by Morton. More recent information on hardpan areas was provided by Balance Hydrologics. Evapotranspiration estimates utilized vegetation typing based on the PWA Codes contained in the Baseline Hydrologic Conditions Report (PCR et al, 2002). Reference evapotranspiration rates were obtained from the California Irrigation Management Information System (CIMIS) website (CIMIS, 2003).

Once calibrated for specific sub-basins, the SWMM model was used to model all aspects of the hydrologic cycle (e.g. rainfall, runoff, stream flow, evaporation, infiltration, percolation, and groundwater discharge) over the 53-year period of rainfall records. The output from the model includes:

- Continuous stream flow hydrographs for storm events at any location in the sub-basin
- Continuous stream flow hydrographs for dry weather base flows
- The amount of precipitation that is infiltrated within each modeled catchment
- A continuous estimation of evaporation losses from the surface and subsurface due to evapotranspiration by plants within each modeled catchment

This output was then used to accumulate, by month, the volume of storm runoff, groundwater flows, and evapotranspiration.

Runoff volumes and flows were predicted for three scenarios:

- Pre-development or existing condition
- Post-development condition without BMPs
- Post-development with BMPs condition

The latter scenario involved evaluating the effectiveness of the flow and water quality management facilities, and trying to optimize the performance of these facilities.

### **3.3 WATER BALANCE AND FLOW DURATION ANALYSIS**

The effect of development on modifying the hydrologic regime within the riparian corridors and the subsequent effect on sediment transport and habitat are “hydrologic conditions of concern”. This effect was analyzed by comparing pre- versus post-development monthly *water balance* and *flow duration*.

#### **3.3.1 Water Balance Analysis**

This Conceptual WQMP strives to manage the overall balance, termed “*water balance*”, of all the hydrologic components of the water cycle. The water balance concept is a useful accounting tool for evaluating and controlling the effects of land use changes on hydrology. A water balance, like a checkbook balance, is intended to show the balance between the “deposits”, which include precipitation and irrigation, and “withdrawals” which include (1) infiltration into the soils, (2) evapotranspiration, and (3) water which runs off the surface of the land. This latter “withdrawal” is called surface runoff and occurs during storm events or wet weather conditions. Surface runoff includes runoff from open areas as well as runoff from urban areas. The water balance is a monthly accounting of how precipitation and irrigation water becomes distributed among (a) surface runoff, (b) groundwater infiltration that contributes to base flows in streams or deep groundwater recharge, and (c) evapotranspiration. The elements in the water balance are described below and are depicted in Figure 3-1.

Water that infiltrates into the ground ultimately moves down gradient and can contribute to stream flows. The contribution of groundwater flow provides for flow in streams when it is not raining, and it often referred to as “base flow”. In semi-arid areas, the water balance varies dramatically from season to season, and from stream to stream. In streams where the groundwater storage is sufficient to sustain stream flows throughout the year, the streams are referred to as perennial. In streams where groundwater aquifers have limited infiltration capacity, the base flows are limited to the wet season and the streams are called intermittent or

ephemeral streams. In the San Juan and San Mateo watersheds, both types of streams exist, and the distinction is carefully preserved in the impact analysis.

A key element in the evaluation of impacts for the proposed alternatives is modeling changes to the water balance caused by development and the extent to which the existing water balance could be maintained using BMPs. The description of the overall modeling approach is provided below and in Appendix A.

- *Precipitation.* In undeveloped areas, precipitation is the main source of water to the watershed. Precipitation occurs primarily as rain from general winter storms during the wet season from October through March. Little rainfall occurs during the dry season from April through September. The average annual rainfall in the study area is about 15 inches.
- *Landscape Irrigation.* In developed areas, the importation of non-domestic water supplies for irrigation is an important additional source of water in semi-arid areas
- *Surface Runoff.* The amount of surface runoff from precipitation depends on the rainfall intensity, vegetation, slope, soil properties, and antecedent soil moisture. Impervious areas and drainage infrastructure associated with urban development can dramatically increase surface runoff if hydrologic responses are not considered and/or hydrologic source controls are inadequate.
- *Infiltration.* For typical small frequent storms, the vast majority of the precipitation will infiltrate into the subsurface. The amount and rate of infiltration depends on the surficial and sub-surface soil types, vegetation coverage, slope, and soil moisture. Infiltration diminishes over the duration of storm events and in relation to the state of saturation in the soils. Urban development can potentially cause hydromodification by reducing infiltration areas with impervious surfaces and also by irrigating the pervious areas.
- *Groundwater Discharge and Base flows.* Groundwater discharge supports dry season stream flow and wet season base flow between storms. The duration and aerial extent of groundwater flows vary among the sub-basins, influenced by the geologic and hydrologic characteristics of the sub-basins. Sandy sub-basins (Chiquita and Gobernadora) support perennial or near perennial flows. Other sub-basins only sustain intermittent or ephemeral stream flow following the rainy season because the geologic conditions do not enable the storage and movement of substantial volumes of water to the creek through groundwater.
- *Evapotranspiration.* Plant roots uptake water from the soils and transpire the water through pores in the leaves. Plant water requirements depend on the type of plant, the root structure, the time of year, and the availability of water. Many plants such as coastal sage scrub have relatively low water requirements whereas wetland and riparian plants

such as willows have high water usage. Typically, plant water uptake is higher in the summer.

Historical dry and wet cycles over a period of years or decades have an important effect on the water balance, and thus the water balance analyses were conducted for dry and wet cycles within the available rainfall record. In semi-arid areas, the variability in the water balance between wet and dry cycles is important to characterize when defining the baseline conditions.

Anticipated water usage for landscape irrigation was incorporated into the water balance based on data obtained from the Santa Margarita Water District's *Plan of Works for Improvement Districts 4C, 4E, 5, and 6* (Tetra Tech, 2003). The District receives domestic water supply from the South County Pipeline, which conveys imported water from the Metropolitan Water District of Southern California to south Orange County via the Allen-McColloch Pipeline. The San Juan Groundwater Basin, which underlies the Planning Area, is another potential supply source. RMV has historically taken up to 3,500 acre-feet per year from this basin for agricultural irrigation. However, because of the uncertainty regarding water reliability and water quality for domestic supply, it was assumed in the *Plan of Works* report that 100 percent of the domestic water supply for the Planning Area will come from imported water via the South County Pipeline (Tetra Tech, 2003).

The Chiquita Water Reclamation Plant (CWRP) will supply non-domestic water through tertiary treatment of domestic wastewater. Groundwater supply from the San Juan Groundwater Basin could augment the reclaimed water supply provided by the CWRP. Although the groundwater is high in TDS, treatment might not be required for landscape and golf course irrigation. However, because water reliability and water quality have not been established at this time, it is assumed for the *Plan of Works* that groundwater from the San Juan Groundwater Basin will not be available and 100 percent of the non-domestic water supply will come as reclaimed water from CWRP (Tetra Tech, 2003).

Based on this information, the water balance analysis assumed that all irrigation water will be imported from outside the sub-basin.

An example illustration of the existing conditions water balance results is shown in Figure 3-2 for the Chiquita Sub-basin. The water balance reflects the entire 53 year rainfall record used in the SWMM modeling. The figure shows the predicted monthly water balance for existing conditions in terms of surface runoff, groundwater infiltration that ultimately will contribute to stream base flows, and evapotranspiration. Surface runoff is predicted to occur in the months of November through April and constitutes only about one to three percent of the water balance. The majority of water is predicted to either infiltrate or evapotranspire. The infiltration that feeds base flows continues throughout the year, which is consistent with the observation that Chiquita is perennial in its lower reaches. Base flows are predicted to be highest in February through March, while evapotranspiration peaks in April and May.

### **3.3.2 Flow Duration Analysis**

The impacts of urbanization on hydrology include increased runoff volumes, peak flow rates, and the duration of flows, especially modest flows less than the 10 year event. Yet it is these more frequent, modest flows that can have the most effect on long-term channel morphology (Leopold, 1997). The effect of changes in flow on stream geomorphology is a cumulative one; therefore the magnitude of the flows (volume and flow rate), how often the flows occur (the frequency), and for how long (the duration) are all important. Managing the frequency and duration of flows is referred to herein as “*flow duration matching*” and refers to matching the post-development flow duration conditions with pre-development conditions. This matching is achieved through appropriate sizing of a flow duration basin and design of the outlet structure. In order to achieve flow duration matching, “*excess flows*”, defined as the difference in runoff volume between the post-development without controls condition and the pre-development condition, must be captured and either infiltrated, stored and recycled, or diverted to a less sensitive stream or stream reach. The technical aspects of the flow duration analysis are presented below, along with an example of flow duration matching.

Flow duration can be expressed in a “histogram form” that illustrates the amount of time that flow in a stream is within various ranges (Figure 3-3), or alternatively in the form of a “cumulative distribution” that illustrates how often flow exceeds a given value. The latter form is referred to as a “flow duration curve”. Note that a flow duration analysis addresses all flows in a given record and is different from a peak flow frequency analysis as is conducted for flood control.

An example flow duration curve for a catchment in the Gobernadora Sub-basin is shown in Figure 3-4. The three curves correspond to pre-development or existing conditions, post-development without control, and post-development with flow control. The post-development curve illustrates that the effect of development is to increase the duration of flows; that is, the flow duration curve moves to the right indicating that both volume and duration of flows increase. Also note that this is a logarithmic scale on the horizontal axis, so small changes along the axis may indicate large changes in volume and duration. The effect of flow control is to reduce the durations to more closely approximate the existing condition.

The flow duration analyses were conducted for the 53-year continuous rainfall record and the dry and wet cycles within that record as described above.

## **3.4 COMBINED FLOW AND WATER QUALITY CONTROL SYSTEM**

In order to achieve flow duration matching, address the water balance, and provide for water quality treatment, a combined flow and water quality control system (termed *combined control system*) will be utilized.

### 3.4.1 Combined Control System Components

The proposed combined control system will include one or more of the following components, each of which provides an important function to the system (Figure 3-5):

- Flow Duration Control and Water Quality Treatment (FD/WQ) Basin
- Infiltration Basin
- Bioinfiltration Swale
- Storage Facility for Recycling Water for Non-Domestic Supply
- Diversion Conduit to Export Excess Flows out of the Sub-basin.

The flow duration control and water quality treatment basin provides the initial flow and water quality treatment control functions to the system. The remaining components address the excess flows, alone or in combination with each other, generated during wet weather. Additional water quality treatment control is also provided in the infiltration basin and bioinfiltration swale.

The treatment components were selected taking into account the pollutants of concern and those BMPs that are effective at treating them (Table 3-1). BMP performance data used for this purpose included national as well as local data, including DAMP Appendix E1, *BMP Effectiveness and Applicability for Orange County* (June 2003).

**Table 3-1: Treatment Control BMP Selection Matrix<sup>1</sup>**

Pollutant of Concern	Treatment Control BMP Categories					
	Biofilters	Detention Basins	Infiltration Basins	Wet Ponds or Wetlands	Filtration	Hydrodynamic Separator Systems
Sediment/Turbidity	H/M	H/M	H/M	H/M	H/M	H/M
Nutrients	L	H/M	H/M	H/M	H/M	L
Trace Metals	M	M	H	H	H	L
Pathogens	U	U	H/M	U	H/M	L
Petroleum Hydrocarbons	H/M	H/M	U	U	H/M	L/M
Pesticides	U	U	U	U	U	L
Trash and Debris	L	H/M	U	U	H/M	H/M

<sup>1</sup>Local WQMP Table A-7.VI-6, except for Trace Metals treatment performance, which was taken from the California Stormwater Best Management Practices Handbook for New Development and Redevelopment (CASQA, 2003).

H/M = High or medium removal efficiency; L = low removal efficiency; U = unknown removal efficiency.

The following sub-sections describe each combined control system component in more detail.

### ***Flow Duration Control and Water Quality Treatment (FD/WQ) Basin***

The flow duration control and water quality treatment (FD/WQ) basin will provide both flow control and water quality treatment in the same basin. Detention basins are the most common means of meeting flow control requirements. The concept of detention is to collect runoff from a developed area and release it at a slower rate than it enters the collection system. The reduced release rate requires temporary storage of the excess amounts in a basin with release occurring over a few hours or days. The volume of storage needed is dependent on 1) the size of the drainage area; 2) the extent of disturbance of the natural vegetation, topography and soils, and creation of impervious surfaces that drain to the stormwater collection system; 3) the desired detention capacity/time for water quality treatment purposes; and 4) how rapidly the water is allowed to leave the FD/WQ basin, i.e., the target release rates.

The FD/WQ basin will incorporate extended detention with a 48-hour draw down time to provide water quality treatment for storm flows. Extended detention basins are designed with outlets that detain the runoff volume from the water quality design storm (e.g., the 85<sup>th</sup> percentile 24-hour event) for some minimum time (e.g., 48 hours) to allow particles and associated pollutants to settle. Laboratory settling column tests indicate that 48 hour settling achieves 70 to 90 percent TSS removal depending on the influent TSS (Grizzard et. al., 1986). According to the data contained in EPA's International BMP Database, the median TSS effluent concentration for extended detention ponds is approximately 30 mg/L (Winer, 2000). TSS effluent concentrations for extended detention basins based on Caltrans studies resulted in a mean concentration of 39 mg/L (DAMP Appendix E1). These fact sheets provide information on design, operation and maintenance, relative removal effectiveness (high, medium, low) and experience with emphasis on California conditions and where available, experience in Orange County. Dry Extended Detention basins are described in fact sheet TC-22 which indicates that the relative removal effectiveness for solids is medium. These fact sheets, along with other data sources, were used to help select appropriate source and treatment control BMPs.

The FD/WQ basin will also incorporate wetland vegetation in a low flow channel along the bottom of the basin for the treatment of dry weather flows and small storm events (Figure 3-6 and 3-7). Water cleansing is a natural function of wetlands, offering a range of treatment mechanisms. Sedimentation of particulates is the major removal mechanism. However the performance is enhanced as plant materials allow pollutants to come in contact with vegetation and soils containing bacteria that metabolize and transform pollutants, especially nutrients. Plants also take up nutrients in their root system. These processes are most effective when the wetland is designed to have a retention time for dry weather flows of one to two weeks. The effectiveness of this natural treatment concept has been demonstrated regionally in the Irvine Ranch Water District's (IRWD) San Joaquin Marsh and in the Prado Dam wetlands that treat reclaimed water that ultimately is recharged in the recharge basins in the Santa Ana River. The success of the San Joaquin Marsh has led IRWD to propose a network of constructed wetlands as part of a Natural Treatment System Master Plan (IRWD, 2003). This plan would locate multiple wetlands throughout the 122 square mile San Diego Watershed. Modeling has indicated that the



system will substantially meet the ultimate target nitrogen reductions called for in the Upper Newport Bay TMDL. Monitoring data collected by Orange County as part of their Regional Monitoring Program are showing that interim nutrient targets are already being met. Dry weather flows and small storm flows will tend to infiltrate into the bottom of the basin after receiving treatment in the low flow wetlands.

To the extent feasible depending on the topography and grade, the FD/WQ basin will be located in areas where there is a larger depth to groundwater and more infiltrative soils. For example, in Chiquita and Gobernadora, FD/WQ basins will be located in the side canyons if feasible. The FD/WQ basin is designed to have two active volumes, a low flow volume and a high flow volume. The low flow volume is designed to capture small to moderate size storms, the initial portions of larger storms, and dry weather flows. The high flow volume is designed to store and release higher flows to maintain, to the extent possible, the pre-development runoff conditions.

### ***Infiltration Basin***

The second element in the combined control system is a separate downstream, shallow basin designed consistent with the LIP requirements for groundwater protection. Suitable soils are those having a high infiltration capacity. Such conditions tend to be more prevalent in the San Juan Creek watershed in contrast to the San Mateo Creek watershed. Water captured in the low flow volume of the FD/WQ basin will be routed to the infiltration basin after treatment. The infiltration basin is sized to infiltrate all the flows released from the lower volume in the FD/WQ basin; nonetheless, an overflow system would convey excess flows that may occur during very wet years to the bioinfiltration swale discussed below. Additional water quality treatment is achieved in the subsurface soils below the infiltration basin through the natural filtering ability of the soil.

Infiltration is identified as having a high/medium removal efficiency for bacteria and viruses by the Orange County Local WQMP, and therefore is an appropriate treatment choice for this primary pollutant of concern.

The quality of infiltrated stormwater has been studied extensively and it has generally been concluded that many pollutants in stormwater are effectively treated in the uppermost soil layers of infiltration basins. A Nationwide Urban Runoff Program Project conducted in Fresno, California, indicated that chemicals that tend to adsorb to particulates (e.g., trace metals) are effectively removed in the upper few centimeters of the soil column (Brown & Caldwell, 1984). Even chemicals such as organochlorine pesticides and polycyclic aromatic hydrocarbons in an industrial catchment in Fresno were found to be adsorbed to the upper 4 centimeters of sediment (Schroeder, 1995).

A nationwide review by Pitt (1994) pointed out that the greatest risk to groundwater was associated with dissolved pollutants such as nitrates that are relatively mobile in groundwater, and especially in soil conditions that lack organics. Features of the proposed combined control system that guard against groundwater contamination include: (1) pretreatment of all runoff in a

FD/WQ basin (see review discussion of the ability of natural treatment systems to remove dissolved pollutants such as nitrates) before it enters the infiltration basin, and (2) locating infiltration basins where there is at least 10 feet of separation to the groundwater. Some incidental infiltration will occur in the FD/WQ basin upstream of the infiltration basins; however, in these basins pollutants will be taken up by the wetland vegetation and the adsorptive organic layer that will form on the bottom of the basin.

### ***Bioinfiltration Swale***

The third element of the combined control system is a bioinfiltration swale that leads from the FD/WQ basin to the stream channel. A bioinfiltration swale is a relatively flat, shallow vegetated conveyance channel that removes pollutants through infiltration, soil adsorption, and uptake by the vegetation. Pollutant removal in bioinfiltration systems is sensitive to swale length and detention time, but well designed swales show good performance for many pollutants. For example, according to EPA's International BMP database, the mean effluent TSS from bioswales is about 24 mg/L. Median TSS removal ranges from about 70 to 90 percent depending on the swale type (Winer, 2000). According to DAMP Appendix E1, vegetated swales studied by Caltrans at highway sites achieved a mean effluent concentration of 47 mg/L.

In areas characterized by terrains with good infiltration capabilities, flows released from the FD/WQ basin and carried in the bioinfiltration swale will mimic pre-development conditions, in which low flows infiltrate in the soils and only high flows reach the main stem of the stream channel. In catchments where development is located on less pervious soils and therefore pre-development runoff is higher, the swale may be lined to better mimic pre-development hydrology.

Flows in the swales also will be controlled by the upstream flow duration/water quality basins so as to minimize the re-suspension of sediments and associated pollutants during high flow events.

### ***Storage Facility for Recycling Water for Non-Domestic Supply***

The fourth possible element of the combined control system is storage of surface water flows for recycling where there is opportunity for reuse of water for irrigation, such as a golf course, residential common area, or local park. Diversion of outflows from the FD/WQ basin to non-domestic water supply reservoirs will be conducted if feasible and cost effective.

### ***Diversion Conduit to Export Flows out of the Sub-basin***

The fifth possible element of the combined control system is the provision to export flows out of the sub-basin. This element provides an additional option that may be employed to better preserve the pre-development water balance within the sub-basin. Such diversions may be desirable where excess runoff could result in increased stormwater flows or increased base flows in sensitive streams. The diversions would be for excess runoff only and would only be feasible for development that adjoins other sub-basins having less sensitive stream channels, or are close

to San Juan Creek or Lower Cristianitos Creek, which have characteristics that allow them to handle additional flows without causing damage to the stream channel. In some locations, such as Cañada Chiquita, it may also be feasible to divert flows to the wastewater treatment plant for reclamation.

Although the concept shown in Figure 3-5 is the basis for the impact analysis, the actual application of the concept to specific development area within each catchment could differ. For example, alternative infiltration opportunities could include golf course water features, or opportunities within the development itself, including the use of recreation fields or common landscaped areas for detention or infiltration, or roadside infiltration trenches. Non-domestic water supply reservoirs could also be used to store water for irrigation or other non-potable use, which would reduce the amount of infiltration required to match flow durations. Figures 3-6 and 3-7 are graphical illustrations of the plan and section views of the combined control system concept.

### **3.4.2 Sizing and Design of Flow Duration and Water Quality Basins**

The FD/WQ basins are sized to maintain, to the extent possible, the pre-development runoff volume and flow duration over the total range of flows predicted by the hydrologic model for a 53-year rainfall record at the Trabuco Canyon rain gauge. Maintaining the pre-development duration of flows serves to control increases in downstream channel erosion that may otherwise occur due to development. The simplest way to visualize this control strategy is a histogram of pre- and post-development flows which shows the duration of flows within various “flow bins”, where a flow bin is defined as a specific range of flows. For example, a sequence of flow bins could contain all flows between 10 to 20 cfs, 20 to 30 cfs, 30 to 40 cfs, 40 to 50 cfs, etc. Figure 3-4 illustrates the concept of a flow duration histogram for pre-development conditions and post development conditions without any flow control. To maintain flow duration requires that the combined control system modify the post-development flow frequency (counts) shown in the figure such that the post-development-with-controls flow frequency matches the pre-development flow frequency for each flow bin.

The FD/WQ basins were sized using an iterative process of adjusting basin storage while selecting and adjusting orifice sizes in the outlet structure in the following manner:

1. The low flow volume within the basin was initially sized to capture the increase in runoff volume that is generated from the impervious surfaces. This capture volume is dependent on the development characteristics, the soil types, and the magnitude of change in runoff created by the proposed development. For example, for development bubbles in the Gobernadora Sub-basin where proposed development would be located on extensive areas of hardpan, the capture volumes required were small, or in some cases, zero.
2. Once the lower volume was sized to capture the correct runoff volume, the upper volume of the basin was sized to detain and discharge larger flows through a specific set of orifices in such a way as to reproduce the pre-developed flow duration curve. The

number, diameter, and elevation of these orifices were determined using a trial and error approach. Experience indicates that sizing the lower portion of the basin to capture the correct volume of runoff, and designing the outlet structure to detain and discharge high flows from the upper portion of the basin allows one to match the pre-development flow duration curve.

The effectiveness of the combined control system, by including a sequence of treatment controls, will be shown in later sections to meet or exceed the “percent treated” performance standards called for in the Orange County Local WQMP.

### ***FD/WQ Basin Sizing Example***

Table 3-2 below presents the results for Gobernadora Catchment 1 as an example to illustrate FD/WQ basin sizing. The first group of data specifies the basin footprint (area), side slopes, and resulting basin dimensions. The second group of data specifies the orifice sizes and elevations. The third group of data defines how the area, volume (V2), and discharge (O2) of the basin vary with the water depth in the basin. The table clearly illustrates how the various sets of orifices affect outflow as a function of water depth in the basin.

Note that there is no unique solution to matching flow duration and that a number of orifice configurations and basin sizes can reproduce the flow duration curve and capture volumes. Thus some of the variability between catchments is due to this non-uniqueness as well as catchment specific conditions.

There are four sets of orifices that range in size from 9.5 to 18-inches and range in elevation from 0 to 3.7 feet. The required number of orifices and flow area are also provided. Figure 3-6 illustrates the configuration of orifices in an outlet structure headwall. Other configurations are possible, as well as other types of discharge devices, such as sharp or broad crested weirs. The final basin has an area of 4.2 acres, a depth of 5 feet, and total storage volume of about 20 acre-feet. The low flow volume is essentially the storage up to 3 feet, or to the bottom of the row labeled Orifice Row 2 (Figure 3-8). The orifices labeled Orifice Row 1 help to maintain the proper number of hours of very low flows. The area of the single orifice in Row 1 is too small to significantly affect the drain time, which is an important consideration for water quality treatment. (Clogging of small orifices is always of concern, but measures such as extending a vertical riser with gravel packs and filter fabric can be used to avoid clogging.) Table 3-3 shows the resulting drain time after sizing the combined control system for flow duration and volume control in Gobernadora Catchment 1. The objective is to provide about 48 hours of detention at 3-foot depth for water quality treatment. The 3-foot elevation is the division between the low and high volumes. This system provides about 48 hours of detention for storms that are large enough to fill the lower portion of the basin, and at least 24 hours for smaller storms that only fill the basin to 1 foot depth, as recommended in the California Stormwater BMP Handbook (CASQA, 2003). This design criterion ensures that even very small storms receive reasonable treatment. These drain times are typical of all of the proposed FD/WQ basins.

**Table 3-2: Pond Design Using Flow Duration Control**

POND DESIGN USING FLOW DURATION CONTROL									
width	length	side slope (H:1V)	□t (sec)		VOLUME 19.8 AC-FT				
400	400	3	600		SURF. AREA 4.2 AC				
<b>ORIFICES</b>	@ depth (ft)	#	diameter (in)	diameter (ft)	A	Total A	Asqrt(2g)	Cd	
Orifice 0	0	1	9.50	0.792	0.4922	0.492	3.950	0.62	Diverted
Orifice 1	2	1	10.00	0.833	0.5454	0.545	4.377	0.62	To Stream
Orifice 2	3	20	15.00	1.250	1.2272	24.5	197.0	0.62	To Stream
Orifice 3	3.7	20	18.00	1.500	1.7671	35.3	283.6	0.62	To Stream
<b>STAGE</b>	<b>Area</b>	<b>V2</b>	<b>Retained</b>	<b>FlowOri1</b>	<b>FlowOri2</b>	<b>FlowOri3</b>	<b>O2</b>	<b>0.5O2Dt</b>	<b>0.5O2Dt+V2</b>
0.0	160000	0	0.00	0.00	0.00	0.0	0.0	0	0
0.5	162409	80602	1.68	0.00	0.00	0.0	1.7	503	81104
1.0	164836	162412	2.37	0.00	0.00	0.0	2.4	711	163123
1.3	166056	203773	2.65	0.00	0.00	0.0	2.7	795	204568
1.5	167281	245441	2.90	0.00	0.00	0.0	2.9	871	246311
1.8	168510	287414	3.14	0.00	0.00	0.0	3.1	941	288355
2.0	169744	329696	3.35	0.00	0.00	0.0	3.4	1006	330702
2.3	170982	372287	3.56	1.313	0.00	0.0	4.9	1461	373747
2.5	172225	415188	3.75	1.857	0.00	0.0	5.6	1681	416869
2.8	173472	458400	3.93	2.275	0.00	0.0	6.2	1862	460261
3.0	174724	501924	4.11	2.626	0.00	0.0	6.7	2020	503944
3.3	175980	545762	4.27	2.936	59.09	0.0	66.3	19891	565653
3.5	177241	589915	4.43	3.217	83.57	0.0	91.2	27367	617281
3.8	178506	634383	4.59	3.474	102.35	38.1	148.5	44542	678925
4.0	179776	679168	4.74	3.714	118.19	93.2	219.9	65958	745126
4.3	181050	724271	4.89	3.940	132.14	126.2	267.2	80154	804425
4.5	182329	769694	5.03	4.153	144.75	152.2	306.2	91846	861539
4.8	183612	815436	5.17	4.355	156.35	174.4	340.3	102078	917515
5.0	184900	861500	5.30	4.549	167.14	194.0	371.0	111311	972811
			IO %Error	%Stream Q	%Treated	Max Stage			
			0.00386	0.37	0.63	4.51			

**Table 3-3: Drain Time as Function of Stage in FD/WQ Basin**

<b>Stage (feet)</b>	<b>Drain time (hours)</b>	<b>Cumulative Drain Time (hours)</b>	<b>Storage (ac-ft)</b>
0	0	0	0
0.50	13.4	13.4	1.9
1.00	9.6	22.9	3.7
1.25	4.3	27.3	4.7
1.50	4.0	31.3	5.6
1.75	3.7	35.0	6.6
2.00	3.5	38.5	7.6
2.25	2.4	40.9	8.5
2.50	2.1	43.0	9.5
2.75	1.9	45.0	10.5
3.00	1.8	46.8	11.5
3.25	0.2	47.0	12.5
3.50	0.1	47.1	13.5
3.75	0.1	47.2	14.6
4.00	0.1	47.2	15.6
4.25	0.0	47.3	16.6
4.50	0.0	47.3	17.7
4.75	0.0	47.4	18.7
5.00	0.0	47.4	19.8

## 3.5 WATER QUALITY ANALYSIS

### 3.5.1 Surface Water

#### *Water Quality Modeling – Wet Weather Flows*

The purpose of the water quality analysis was to compare pre- vs. post-development loads and concentrations for the pollutants of concern. An empirical method is used that incorporates measured data of stormwater quality in runoff from specific land use types. The ideal form of the data is event mean concentrations, which are flow composite samples. Stormwater quality data is quite variable and the preferred sources of data are those where there are sufficient storm events sampled that statistical measures are reliable. Sources of land use runoff water quality data included that collected by Wildermuth Environmental within the Project area (presented in Appendix C), data collected by Los Angeles County (Los Angeles County, 2000), and data collected by Ventura County (VCFCD, 1997 - 2001). Pollutant loads were estimated by combining the water quality data with flow estimates obtained from the SWMM modeling.

Orange County also conducts an extensive Regional Monitoring Program, however the focus is on monitoring in streams to help evaluate TMDL compliance, rather than monitor in storm drain systems where the tributary areas are dominated by a single land use. These data have been used in helping to establish the environmental setting, but are not suitable as input for modeling land use runoff quality.

In addition to predicting runoff water quality, the effectiveness of proposed treatment facilities was predicted. BMP effectiveness data were obtained in the form of effluent water quality for various BMP types as contained in the ASCE/EPA International BMP Database (Strecker et al, 2001). Relative performance information provided in the Orange County BMP Fact Sheets were also reviewed for consistency. BMPs for golf courses were selected based on previous experience of GeoSyntec Consultants and the Arroyo Trabuco Golf Course WQMP (Psomas, 2003). Loads were estimated by combining the flows provided by SWMM with the effluent water quality data.

The preferred form of data used to address water quality are flow composite storm event samples, which are measures of the average water quality during the event. To obtain such data usually requires automatic samplers that collect data at a frequency that is proportionate to flow rate. The pollutants for which there are sufficient flow composite sampling data are: total suspended solids, nutrients, and trace metals.

The other pollutants of concern - pathogens, pesticides, hydrocarbons, and trash and debris, are not amenable to this type of sampling either because of short holding times (e.g., pathogens), difficulties in obtaining a representative sample (e.g., hydrocarbons), low detection levels (e.g., pesticides), or cost. These pollutants were addressed qualitatively using literature information

and best professional judgment due to the lack of statistically reliable monitoring data for these pollutants. Site specific monitoring data collected by Wildermuth Environmental within the Project area were also used to qualitatively address certain pollutants, especially pesticides.

### ***Dry Weather Flows***

The wet weather water quality analysis focuses on the changes in water quality during storm events. However, water quality effects during dry weather conditions also are important, especially given that much of the dry weather flows in this region are of anthropogenic origin.

Dry weather flows are typically low in sediment because the flow rates are relatively low and coarse suspended sediment tends to settle out or are filtered out by vegetation. As a consequence, pollutants that tend to be associated with suspended solids (e.g., phosphorus, some trace metals, and some pesticides) are typically found in very low concentrations in dry weather flows. The focus of the dry weather analysis is therefore on constituents that tend to be dissolved, e.g., nitrate, or constituents that are as small as to be effectively transported, e.g., bacteria and some organophosphate pesticides. The analysis conducted for dry weather flows was further simplified because most post-development dry weather flows will be infiltrated in the FD/WQ basins, or subsequent downstream facilities prior to any discharge downstream.

### **3.5.2 Groundwater Quality**

Groundwater quality will be protected from potential impacts through the implementation of the restrictions on the use of infiltration BMPs outlined in the DAMP. The DAMP restrictions include the following:

- Landscape drainage features will be designed so that they promote infiltration of runoff, but do not inject runoff so that it bypasses the natural processes of filtering and transformation that occur in the soil.
- Reasonable steps will be taken to prevent the illegal discharge of wastes to the drainage system.
- Infiltration basins will not collect drainage from, or be located near, work areas where wash water or liquid wastes will be generated or where hazardous chemicals are stored.
- Infiltration basins will be clearly marked with “no dumping” signs and will be inspected regularly.
- Source Control BMPs will be implemented at a level appropriate to protect groundwater quality (see WQMP Section 4.1.3).
- All runoff will be pretreated in a FD/WQ basin before it enters an infiltration basin.



- The vertical distance from the base of all infiltration basins to the seasonal high groundwater mark will be at least 10 feet.
- The soil through which infiltration is to occur has physical and chemical characteristics (such as appropriate cation exchange capacity, organic content, clay content, and infiltration rate) that are adequate for proper infiltration durations and treatment of urban runoff for the protection of groundwater beneficial uses.
- Stand alone infiltration BMPs will not be used directly for areas of industrial or light industrial activity; areas subject to high vehicular traffic; automotive repair shops; car washes; fleet or RV storage areas (bus, truck, etc.); nurseries; and other high threat to water quality land uses and activities as designated in the Orange County Local Implementation Plan. Drainage from these areas will be combined with runoff from residential and open space areas prior to receiving treatment and infiltrating in a combined control system facility.
- The horizontal distance between the base of any infiltration basin and any water supply wells will be 100 feet or as determined on an individual, site-specific basis by the County of Orange.

### **3.6 SPATIAL SCALES OF ANALYSIS**

The various analyses described above were applied at one or more of the following spatial scales.

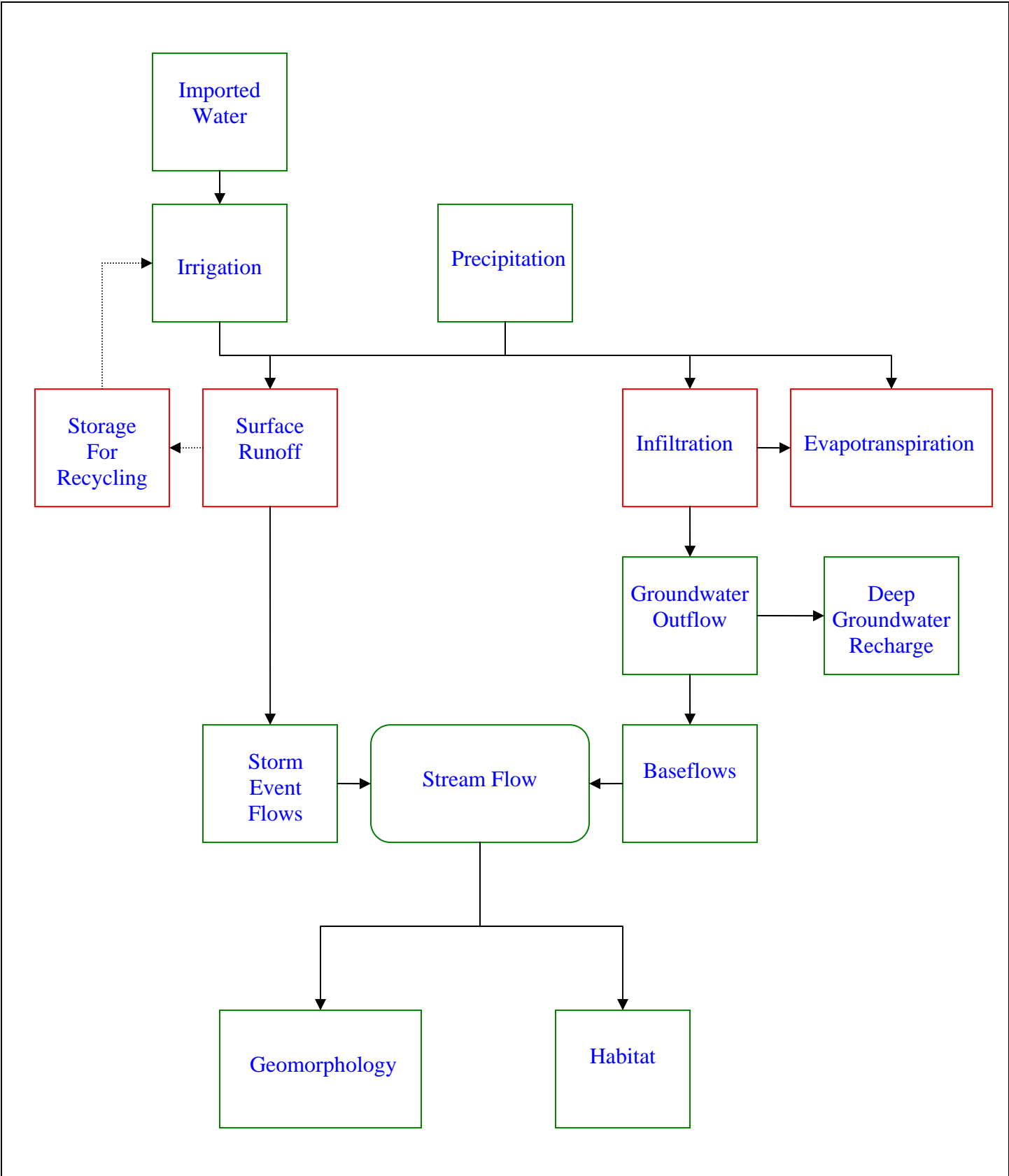
- Development planning area scale
- Catchment scale
- Sub-basin scale
- Watershed Scale

The development planning area is the area affected by development, and is the area which causes the major changes in surface water hydrology and water quality. The flow duration analysis and selection and design of the BMPs were conducted at this scale. Sizing BMPs for the other scales would have led to much larger flow control and water quality facilities.

Each of the sub-basins was divided into catchments for the hydrologic and water quality modeling. This sub-aggregation is necessary to take into account the variability in soils, vegetation, topography, and land use in the modeling. The water quality modeling and water balance were conducted at this scale, but the results were aggregated and are presented primarily on the sub-basin scale.

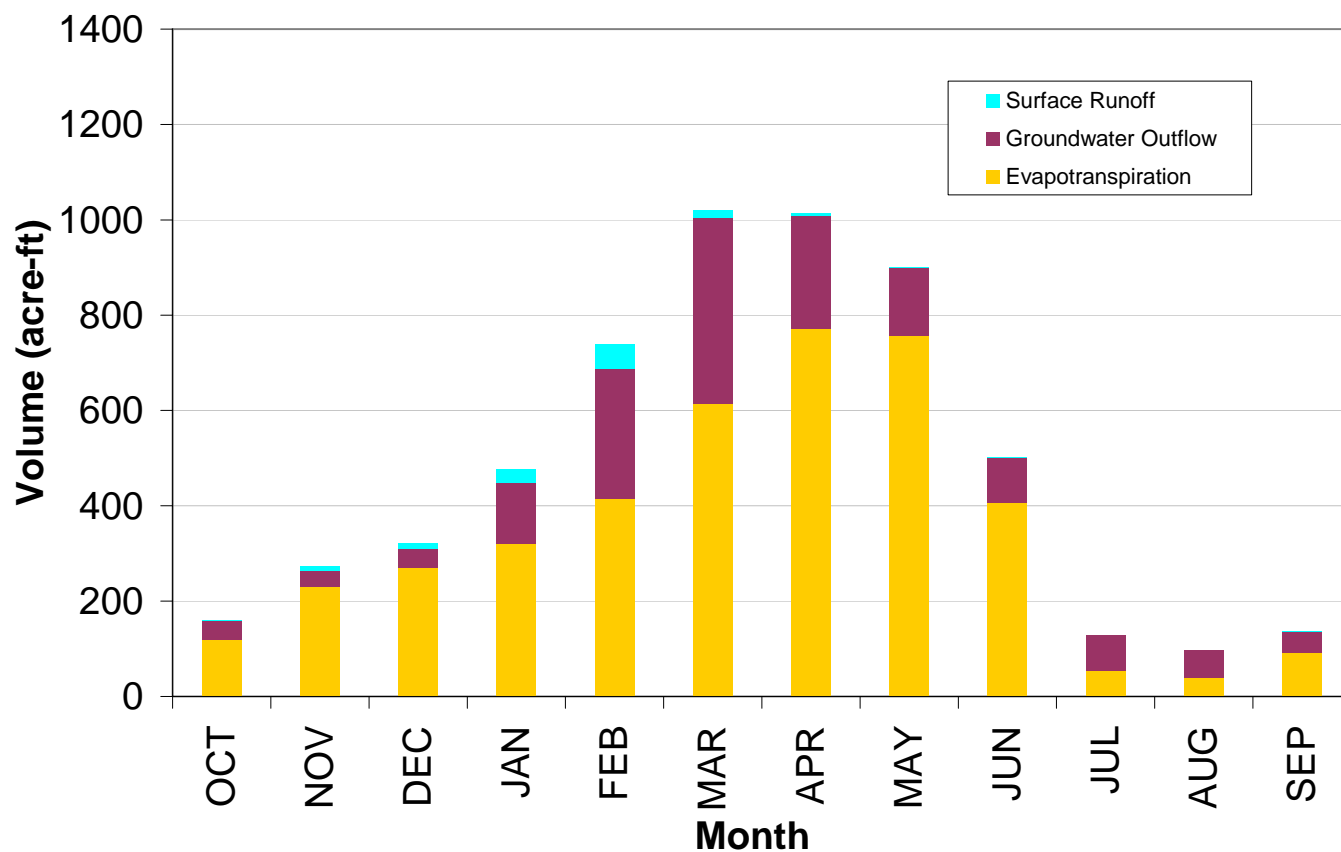
The sub-basin scale is the basic planning scale that has been used in the various resource studies conducted to date, and has been used for the WQMP development and impact assessment. This scale allows for analysis of the potential impacts of the proposed land uses on the hydrology and water quality of the tributaries to San Juan Creek and San Mateo Creek within the boundary of the proposed alternatives. The WQMP strives to protect and enhance the designated beneficial uses which are provided in these tributaries.

The watershed scale encompasses various sub-basins and includes portions of two watersheds - the San Juan Creek watershed and the San Mateo Creek watershed. Impacts at this scale may include other factors beyond the proposed alternatives (e.g., the effects of major transportation corridors) and are addressed in the cumulative impact analysis in Chapter 8. Impacts to San Juan Creek and San Mateo Creek are assessed as cumulative impacts.



**Figure 3-1  
Water Balance Conceptual Model**

### Chiquita Sub-Basin - All Years



**Figure 3-2  
Example Water Balance**

March 2004

Water Quality Management Plan  
Rancho Mission Viejo



# Pre vs. Post-Development Flows

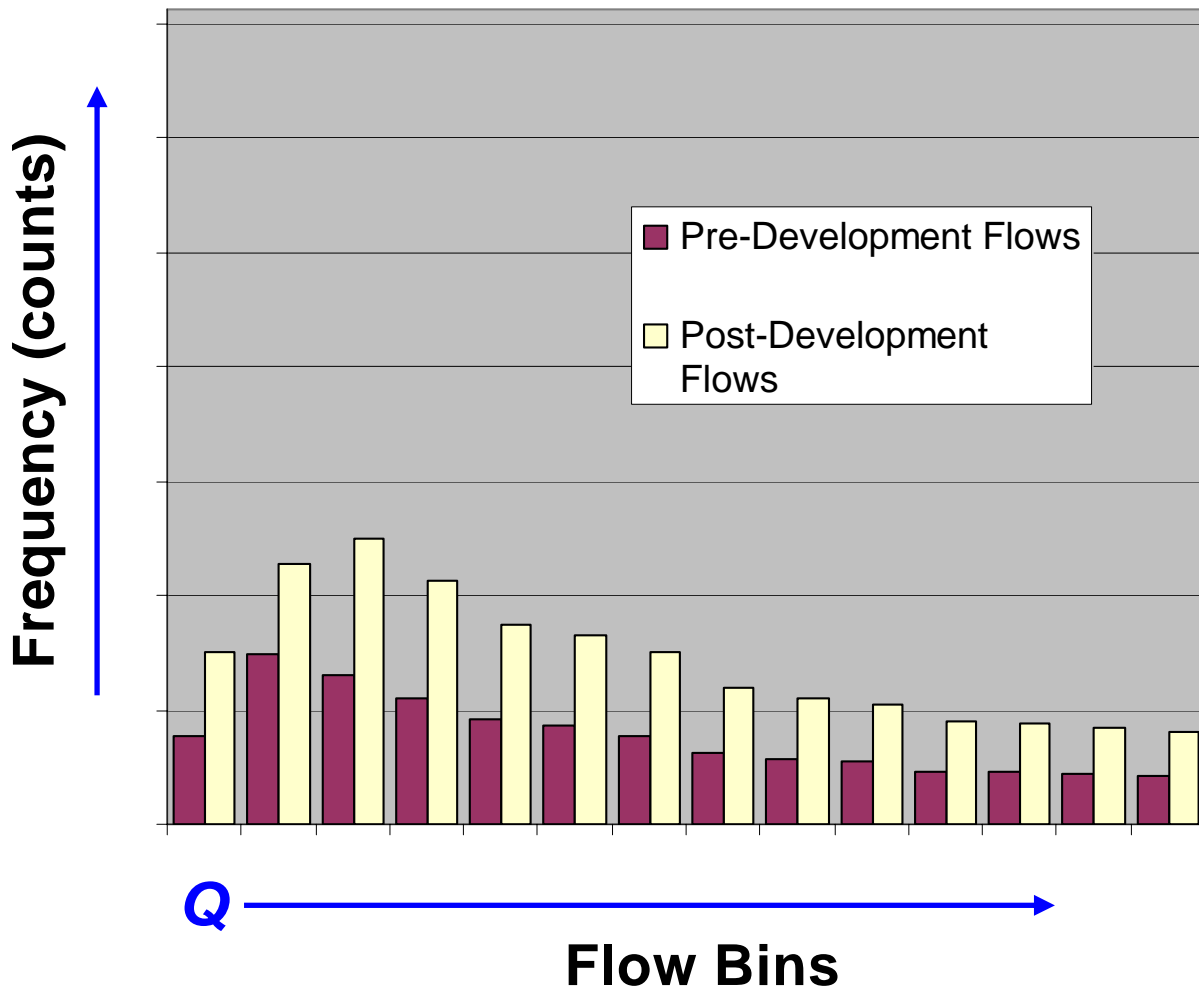
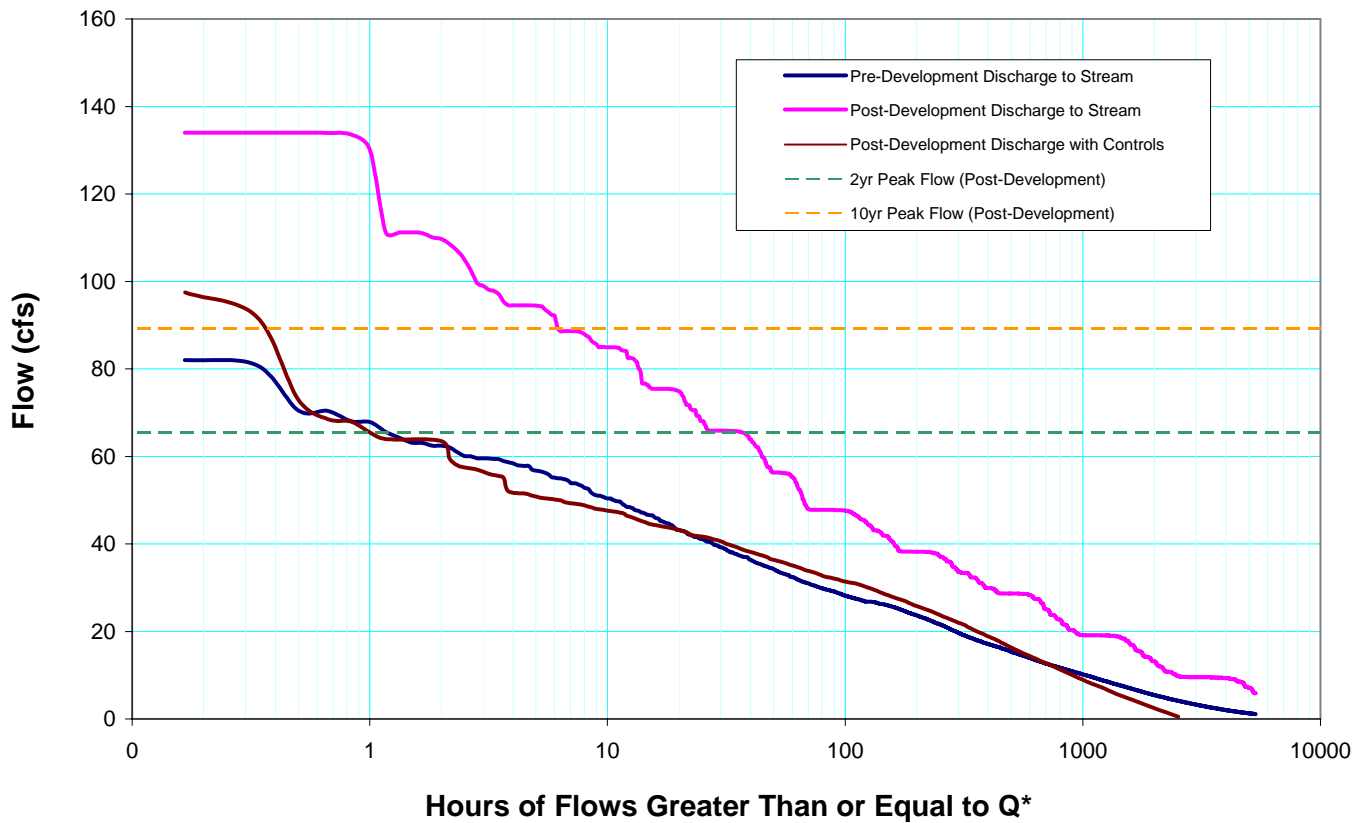


Figure 3-3  
Flow Histograms for Pre- and Post-Development

### Cumulative Frequency Distribution



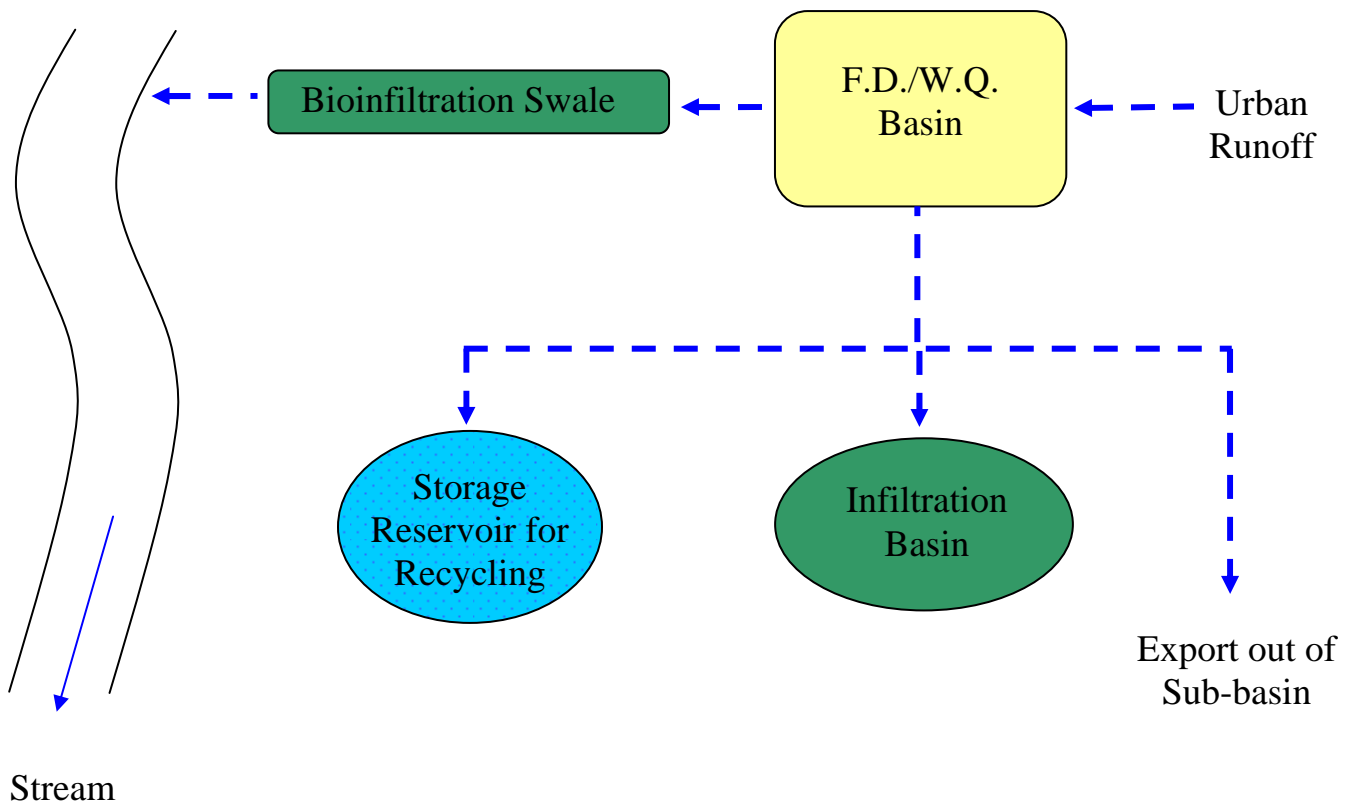
\* for 53 years of rainfall record; Water Years 1949-2001

**Figure 3-4**  
**Example Flow Duration Curves for Cañada Gobernadora- Catchment 3**

March 2004

Water Quality Management Plan  
 Rancho Mission Viejo





**Figure 3-5**  
**Schematic Illustration of Facilities in the Combined Control System**



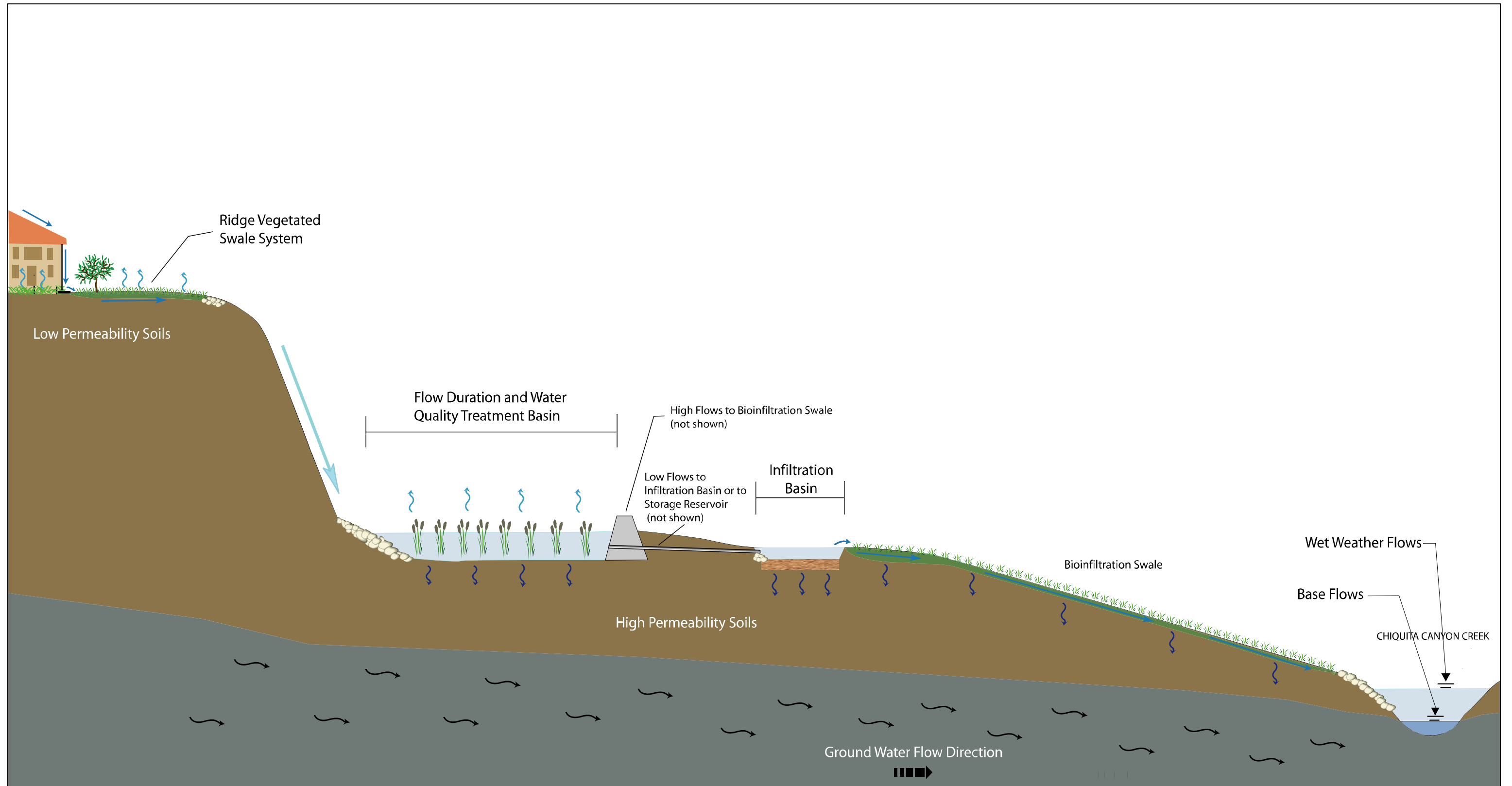
**Figure 3-6**  
**Combined Flow and Water Quality Control System – Plan**

March 2004

Water Quality Management Plan  
 Rancho Mission Viejo





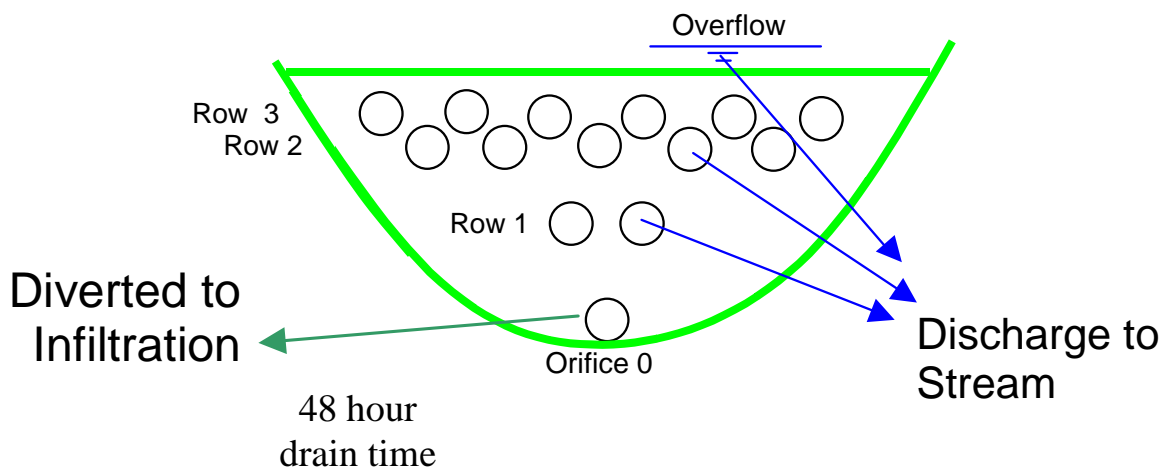


**Figure 3-7**  
**Combined Flow and Water Quality Control System - Profile**

March 2004

Water Quality Management Plan  
 Rancho Mission Viejo





**Figure 3-8**  
**Schematic Illustration of an Outlet Structure**

## 4 WATER QUALITY MANAGEMENT PLAN ELEMENTS

This chapter presents the Water Quality Management Plan elements for Alternatives B-4 and B-9. The WQMP elements have been developed based on the general Local WQMP requirements (identified by italics) and sub-basin specific water quality and hydrologic issues as identified in the *Draft Watershed and Sub-basin Planning Principles* (NCCP/SAMP Working Group, 2003a). The WQMP elements can be divided into two categories: 1) general elements that apply to all of the Planning Areas, and 2) sub-basin specific elements. The general elements - including site design BMPs, source control BMPs, and operations and maintenance - are presented in Section 4.1.

In order to address considerations of terrains and hydrologic conditions of concern, Sections 4.2 through 4.9 rely on and address information set forth in the *Baseline Conditions Report* (PCR et al, 2002) and in the *Draft Watershed and Sub-basin Planning Principles* (NCCP/SAMP Working Group, 2003a). The Geomorphology/Terrains; Hydrology; Sediment Sources, Storage, and Transport; Groundwater Hydrology; and Water Quality principles from the *Draft Watershed and Sub-basin Planning Principles* have been employed. Additionally, the sub-basin “Planning Considerations” and “Planning Recommendations” have been addressed and employed in formulating flow control and water quality control strategies in response to the geographic-specific conditions found in each sub-basin. The sub-basin specific elements include site assessment, planning considerations, and combined control system conceptual design, and are presented in Sections 4.2 through 4.9.

Alternative B-4 was used to develop the combined control system conceptual designs included in this chapter, except for the Verdugo Sub-basin which is based on the B-9 alternative. Therefore, combined control system conceptual designs have not been presented for all of the alternatives, though the methodology used to select and size system components is generally applicable and would be used to finalize design for the chosen alternative.

### 4.1 GENERAL WATER QUALITY MANAGEMENT PLAN ELEMENTS (WQMP)

#### 4.1.1 BMP Selection

New development and significant redevelopment projects are required by the Local WQMP to develop and implement a Project WQMP that includes BMPs. Priority projects such as the RMV Project must include types of BMPs in each of the following categories:

- *Site Design BMPs;*
- *Source Control BMPs; and*

- *Project-based Treatment Control BMPs and/or participation in an approved regional or watershed management program.*

Projects for which hydrologic conditions of concern have been identified shall also control post-development peak stormwater runoff discharge rates and velocities to maintain or reduce pre-development downstream erosion rates and to protect stream habitat.

The BMPs that have been incorporated into the WQMP have been selected to address the pollutants and hydrologic conditions of concern listed in Chapter 2. Site design BMPs are discussed below in Section 4.1.2 and source control BMPs are discussed in Section 4.1.3. The conceptual combined control system, which addresses both pollutants of concern and hydrologic conditions of concern, is described in Section 3.2. Combined control systems specific to each sub-basin will be discussed in subsequent sections of this chapter.

#### **4.1.2 Site Design BMPs**

Projects can partially address the Local WQMP objectives through the incorporation of appropriate site design BMPs intended to create a hydrologically functional project design that attempts to mimic the natural hydrologic regime. Mimicking a site's natural hydrologic regime can be pursued by:

- Reducing imperviousness, conserving natural resources and areas, maintaining and using natural drainage courses in the municipal storm drain system, and minimizing clearing and grading.
- Providing runoff storage measures dispersed uniformly throughout a site's landscape with the use of a variety of detention, retention, and runoff practices.
- Implementing on-lot hydrologically functional landscape design and management practices.

Runoff from developed areas may be reduced by using alternative materials or surfaces with a lower coefficient of runoff, or "C Factor". The C Factor is a representation of the ability of a surface to produce runoff. Surfaces that produce higher volumes of runoff are represented by higher C Factors. By incorporating more pervious lower-C-factor surfaces into a development, lower volumes of runoff will be produced. Lower volumes and rates of runoff translate directly to smaller treatment design volumes.

The Local WQMP requires that the site design options and characteristics listed in Table 4-1 be considered and incorporated, where applicable and feasible, during the site planning and approval process consistent with applicable General Plan policies, other development standards and regulations, and with any site design BMPs included in an applicable regional or watershed program. The site design BMPs that are incorporated into the WQMP are also listed in Table 4-1.

**Table 4-1: Implementation of Site Design BMPs**

LOCAL WQMP SITE DESIGN OPTION/CHARACTERISTICS	PROJECT IMPLEMENTATION
<b>Design Options</b>	
<p>1. <i>Maximize the permeable area.</i></p>	<ul style="list-style-type: none"> <li>• The proposed development areas are predominantly located on the less infiltrative soils to preserve the permeable substrate often located in the major side canyons and along the valley floor.</li> <li>• In areas not subject to mass grading, the smallest site disturbance area possible will be delineated and flagged and temporary storage of construction equipment will be restricted in these areas to minimize soil compaction on site.</li> </ul>
<p>2. <i>Conserve natural areas.</i></p>	<ul style="list-style-type: none"> <li>• 67% of the total Project area will be conserved as open space in the B-4 Alternative.</li> <li>• 71% of the total Project area will be conserved as open space in the B-9 Alternative.</li> </ul>
<p>3. <i>Construct walkways, trails, patios, overflow parking lots, alleys, driveways, low-traffic streets and other low traffic areas with open-jointed paving materials or permeable surfaces, such as pervious concrete, porous asphalt, unit pavers, and granular materials.</i></p>	<ul style="list-style-type: none"> <li>• Trails in reserve areas and parks, and golf cart paths will be constructed with open-jointed paving materials, granular materials, or other pervious materials.</li> </ul>
<p>4. <i>Construct streets, sidewalks and parking lot aisles to the minimum widths necessary, provided that public safety and a walkable environment for pedestrians are not compromised. Incorporate landscaped buffer areas between sidewalks and streets.</i></p>	<ul style="list-style-type: none"> <li>• Streets, sidewalks, and parking lot aisles will be constructed to the minimum widths specified in the County Land Use Code and in compliance with regulations for the Americans with Disabilities Act and safety requirements for fire and emergency vehicle access.</li> </ul>
<p>5. <i>Reduce widths of street where off-street parking is available.</i></p>	<ul style="list-style-type: none"> <li>• Streets, sidewalks, and parking lot aisles will be constructed to the minimum widths specified in the County Land Use Code and in compliance with regulations for the Americans with Disabilities Act and safety requirements for fire and emergency vehicle access.</li> </ul>

LOCAL WQMP SITE DESIGN OPTION/CHARACTERISTICS	PROJECT IMPLEMENTATION
6. <i>Maximize canopy interception and water conservation by preserving existing native trees and shrubs, and planting additional native or drought tolerant trees and large shrubs.</i>	<ul style="list-style-type: none"> <li>Existing native trees and shrubs will be conserved in the open space reserve areas.</li> <li>Native or drought tolerant non-invasive trees and large shrubs will be incorporated into non-reserve open space and landscaped areas, where feasible.</li> </ul>
7. <i>Minimize the use of impervious surfaces, such as decorative concrete, in the landscape design</i>	<ul style="list-style-type: none"> <li>Impervious surfaces will be minimized in landscape design.</li> </ul>
8. <i>Use natural drainage systems.</i>	<ul style="list-style-type: none"> <li>Vegetated swales will be used to collect runoff where feasible. Bioinfiltration swales will be used to route flows from the FD/WQ basins to the stream channel.</li> </ul>
9. <i>Where soils conditions are suitable, use perforated pipe or gravel filtration pits for low flow infiltration.</i>	<ul style="list-style-type: none"> <li>Infiltration basins are used in the combined control system to manage increases in runoff volume.</li> </ul>
10. <i>Construct onsite ponding areas or retention facilities to increase opportunities for infiltration</i>	<ul style="list-style-type: none"> <li>The combined control system includes a FD/WQ basin, an infiltration basin, and vegetated swales that will provide opportunities for infiltration where soil conditions are suitable.</li> </ul>
11. <i>Other site design options that are comparable, and equally effective</i>	<ul style="list-style-type: none"> <li>Low impact design concepts that are distributed within the development bubble will be considered as options that could reduce the need for treatment.</li> </ul>
<b><i>Design Characteristics</i></b>	
1. <i>Where landscaping is proposed, drain rooftops into adjacent landscaping prior to discharging to the storm drain.</i>	<ul style="list-style-type: none"> <li>Roof runoff for low-density housing, education, or commercial development may be directed to planter boxes or vegetated swales located in common areas, or within individual lots.</li> </ul>
2. <i>Where landscaping is proposed, drain impervious sidewalks, walkways, trails, and patios into adjacent landscaping.</i>	<ul style="list-style-type: none"> <li>Runoff from sidewalks, walkways, trails, and patios will be directed into adjacent landscaping or to vegetated swales.</li> </ul>
3. <i>Increase the use of vegetated drainage swales in lieu of underground piping or imperviously lined swales.</i>	<ul style="list-style-type: none"> <li>Unlined vegetated swales will be incorporated except where such infiltration will affect slope stability.</li> </ul>

LOCAL WQMP SITE DESIGN OPTION/CHARACTERISTICS	PROJECT IMPLEMENTATION
<p>4. Use one or more of the following:</p> <ul style="list-style-type: none"> <li>a. Rural swale system: street sheet flows to vegetated swale or gravel shoulder, curbs at street corners, culverts under driveways and street crossings</li> <li>b. Urban curb/swale system: street slopes to curb; periodic swale inlets drain to vegetated swale/biofilter</li> <li>c. Dual drainage system: First flush captured in street catch basins and discharged to adjacent vegetated swale or gravel shoulder, high flows connect directly to municipal storm drain systems</li> <li>d. Other design concepts that are comparable and equally effective</li> </ul>	<ul style="list-style-type: none"> <li>• Conveyance design will incorporate a rural swale design in estate areas and an urban curb/swale system in residential areas or other design concepts that are comparable and equally effective.</li> </ul>
<p>5. Use one or more of the following features for design of driveways and private residential parking areas:</p> <ul style="list-style-type: none"> <li>a. Design driveways with shared access, flared (single lane at street) or wheel strips (paving only under tires); or, drain into landscaping prior to discharging to the municipal storm drain system</li> <li>b. Uncovered temporary or guest parking on private residential lots may be: paved with a permeable surface; or, designed to drain into landscaping prior to discharging to the municipal storm drain system</li> <li>c. Other design concepts that are comparable and equally effective</li> </ul>	<ul style="list-style-type: none"> <li>• Uncovered temporary or guest parking in residential areas will be paved with a permeable surface, designed to drain into landscaping prior to discharging to the municipal storm drain system, or other design concepts that are comparable and equally effective.</li> </ul>
<p>6. Use one or more of the following design concepts for the design of parking areas:</p> <ul style="list-style-type: none"> <li>a. Where landscaping is proposed in parking areas, incorporate landscape areas into the drainage design</li> <li>b. Overflow parking (parking stalls provided in excess of the Permittee's minimum parking requirements) may be constructed with permeable paving</li> <li>c. Other design concepts that are comparable and equally effective</li> </ul>	<ul style="list-style-type: none"> <li>• Where landscaping is proposed in parking areas, landscape areas will be incorporated into the drainage design, or other design concepts that are comparable and equally effective.</li> </ul>

### 4.1.3 Source Control BMPs

Source controls BMPs (routine non-structural BMPs, routine structural BMPs, and BMPs for individual categories/project features) are required by the Local WQMP within all new development and significant redevelopment projects unless they do not apply due to the project characteristics. The proposed alternative’s land uses include single and multi-family residential, school, roadways, parks, golf courses, commercial (urban activity center, business park, and neighborhood retail), and open space.

#### *Non-Structural Source Control BMPs*

Table 4-2 lists the routine non-structural BMPs from the Local WQMP BMPs that are applicable to the proposed land uses and will be implemented.

**Table 4-2: Routine Non-Structural Source Control BMPs**

Identifier	Name	Check One		If not applicable, state brief reason
		Included	Not Applicable	
<i>N1</i>	<i>Education for Property Owners, Tenants, and Occupants</i>	X		
<i>N2</i>	<i>Activity Restrictions</i>	X		
<i>N3</i>	<i>Common Area Landscape Management</i>	X		
<i>N4</i>	<i>BMP Maintenance</i>	X		
<i>N5</i>	<i>Title 22 CCR Compliance (How development will comply)</i>	X		
<i>N6</i>	<i>Local Water Quality Permit Compliance</i>	X		
<i>N7</i>	<i>Spill Contingency Plan</i>	X		
<i>N8</i>	<i>Underground Storage Tank Compliance</i>	X		
<i>N9</i>	<i>Hazardous Materials Disclosure Compliance</i>	X		
<i>N10</i>	<i>Uniform Fire Code Implementation</i>	X		
<i>N11</i>	<i>Common Area Litter Control</i>	X		
<i>N12</i>	<i>Employee Training</i>	X		
<i>N13</i>	<i>Housekeeping of Loading Docks</i>	X		
<i>N14</i>	<i>Common Area Catch Basin Inspection</i>	X		



Identifier	Name	Check One		If not applicable, state brief reason
		Included	Not Applicable	
N15	<i>Street Sweeping Private Streets and Parking Lots</i>	X		
N17	<i>Retail Gasoline Outlets</i>	X		

The routine non-structural source control BMPs will be implemented as follows:

*Education for property owners, tenants and occupants (N1)* – Education is a key element in the source control plan, as preventing pollutants from entering the storm drain system is the most cost effective of all BMPs. Education must be keyed to the various practices that lead to pollutant generation, but which most homeowners and renters are unaware. Such practices on the surface appear mundane, but actually may have severe cumulative effects on water quality. These practices include car washing, littering, landscape maintenance, cleaning up after pets, etc. Environmental awareness education materials will be provided to all members of the POA periodically. At a minimum, these materials will cover the following topics:

1. The use of chemicals (including household type) that should be limited to the property, with no discharge of specified wastes via hosing or other direct discharge to gutters, catch basins, and storm drains.
2. The proper handling of material such as fertilizers, pesticides, cleaning solutions, paint products, automotive products, and swimming pool chemicals.
3. The environmental and legal impacts of illegal dumping of harmful substances into storm drains and sewers.
4. Alternative household products which are safer to the environment.
5. Household hazardous waste collection programs.
6. Used oil recycling programs.
7. Proper procedures for spill prevention and clean up.
8. Proper storage of materials which pose pollution risks to local waters.
9. Carpooling programs and public transportation alternatives to driving.

*Activity Restrictions (Conditions, Covenants, and Restrictions) (N2)* – Conditions, Covenants, and Restrictions (CC&Rs) will be prepared for the purpose of surface water quality protection, or use restrictions will be developed through lease terms.

*Common Area Landscape Management (N3)* - Ongoing maintenance will be consistent with County Water Conservation Resolution, plus fertilizer and/or pesticide usage will be consistent with County Management Guidelines for Use of Fertilizers (DAMP Section 5.5).

*BMP Maintenance (N4)* – Home Owners Associations (HOAs) or another designated entity shall be responsible for the inspection and maintenance of structural BMPs within their boundaries. The overall scope of the proposed operation and maintenance plan is provided in Section 4.1.4.

*Local Water Quality Permit Compliance (N6)* – Occupants/tenants will be responsible for applying for and complying with appropriate local water quality permits for stormwater discharges from fuel dispensing areas or other areas of public concern to public properties.

*Spill Contingency Plan (N7)* – Occupants/tenants will develop a spill contingency plan which mandates stockpiling of cleanup materials, notification of responsible agencies such as the County of Orange Environmental Health, Fire Department, etc., disposal of cleanup materials, and documentation.

*Hazardous Materials Disclosure Compliance (N9)* – Occupants/tenants will comply with County of Orange ordinances enforced by the fire protection agency for the management of hazardous materials.

*Uniform Fire Code Implementation (N10)* – Occupants/tenants will comply with Article 80 of the Uniform Fire Code enforced by the fire protection agency.

*Common Area Litter Control (N11)* - Litter patrol, emptying of trash receptacles in common areas, and noting trash disposal violations by tenants/homeowners or businesses and reporting the violations to the owner/HOA for investigation will be conducted.

*Housekeeping of Loading Docks (N13)* - Loading docks typically found at large retail and warehouse-type commercial and industrial facilities will be kept in a clean and orderly condition through a regular program of sweeping and litter control and immediate cleanup of spills and broken containers. Cleanup procedures will minimize or eliminate the use of water. If wash down water is used, it will be disposed of in an approved manner and not discharged to the storm drain system. If there are no other alternatives, discharge of non-stormwater flow to the sanitary sewer will be considered only if allowed by the local sewerage agency through a permitted connection.

*Common Area Catch Basin Inspection (N14)* - 80% of all privately-maintained drainage facilities will be inspected each year and, if necessary, cleaned and maintained prior to the storm season, no later than October 15<sup>th</sup> each year; 100 % of all privately-maintained drainage facilities will be inspected, cleaned and maintained in a two year period. Drainage facilities include catch basins and inlets, water quality basins, detention basins, open drainage channels, and lift stations.

*Street Sweeping Private Streets And Parking Lots (N15)* - Streets will be swept prior to the storm season, no later than October 15<sup>th</sup> each year. Parking lots shall be swept weekly at a minimum, weather permitting.

*Retail Gasoline Outlets (N17)* - Retail gasoline outlets (RGOs) will implement the following BMPs:

- Fuel dispensing areas will be paved with Portland cement concrete (or, equivalent smooth impervious surface), with a 2% to 4% slope to prevent ponding, and will be separated from the rest of the site by a grade break that prevents run-on of storm water to the extent practicable. The fuel dispensing area is defined as extending 6.5 feet from the corner of each fuel dispenser or the length at which the hose and nozzle assembly may be operated plus 1 foot, whichever is less. The paving around the fuel dispensing area may exceed the minimum dimensions of the "fuel dispensing area" stated above.
- The fuel dispensing area will be covered and the cover's minimum dimensions will be equal to or greater than the area within the grade break or the fuel dispensing area, as defined above. The cover will not drain onto the fuel dispensing area.
- Outdoor waste receptacle and air/water supply areas will be graded and paved to prevent run-on of storm water to the extent practicable.

***Structural Source Control BMPs***

Table 4-3 lists the routine structural BMPs that are required by the Local WQMP and will be implemented.

**Table 4-3: Routine Structural Source Control BMPs**

Name	Check One		If not applicable, state brief reason
	Included	Not Applicable	
<i>Provide Storm Drain System Stenciling and Signage</i>	X		
<i>Design Outdoor Hazardous Material Storage Areas to Reduce Pollutant Introduction</i>	X		
<i>Design Trash Storage Areas to Reduce Pollutant Introduction</i>	X		
<i>Use Efficient Irrigation Systems and Landscape Design</i>	X		
<i>Protect Slopes and Channels</i>	X		

Name	Check One		If not applicable, state brief reason
	Included	Not Applicable	
Requirements Applicable to Individual Project Features			
<i>Loading Dock Areas</i>	X		
<i>Maintenance Bays</i>	X		
<i>Vehicle Wash Areas</i>	X		
<i>Outdoor Processing Areas</i>	X		
<i>Equipment Wash Areas</i>	X		
<i>Fueling Areas</i>	X		
<i>Hillside Landscaping</i>	X		
<i>Wash Water Controls for Food Preparation Areas</i>	X		
<i>Community Car Wash Racks</i>	X		

The routine structural source control BMPs will be implemented as follows:

*Provide Storm Drain Stenciling and Signage* - all storm drain inlets and catch basins, constructed or modified, within the Project area will be stenciled or labeled. Signs which prohibit illegal dumping will be posted at public access points along channels and creeks within the Project area. Legibility of stencils and signs shall be maintained.

*Trash Area Design* – trash areas will be paved, designed not to allow run-on, screened or walled to prevent off-site transport of trash; and covered to minimize direct precipitation. Connection of trash area drains to the municipal storm drain system will be prohibited.

*Efficient Irrigation* - the timing and application methods of irrigation water will minimize the runoff of excess irrigation water into the stormwater conveyance system (See O&M Plan, Section 4.1.4).

*Protect Slopes and Channels* - stormwater BMPs will be included to decrease the potential for erosion of slopes and/or channels.

*Hillside Landscaping* - hillside areas that are disturbed by project development will be landscaped with deep-rooted, drought tolerant plant species selected for erosion control.

*Loading Dock Areas* - Loading/unloading dock areas will include the following:

- Cover loading dock areas, or design drainage to preclude urban run-on and runoff.
- Runoff from below grade loading docks (truck wells) or similar structures will be treated with a Treatment Control BMP applicable to the use prior to discharge to the storm drain.
- Housekeeping of loading docks will be consistent with N13.

*Community Car Wash Racks* – a designated car wash area that drains to the sanitary sewer or an engineered infiltration system will be included in complexes larger than 100 dwelling units. Signage will be provided prohibiting discharges of car wash water outside of the designated car wash area. Alternatively, car washing will not be allowed.

### ***Golf Course***

A number of site design and source control BMPs listed above apply to the proposed golf courses. The following BMPs address specific issues associated with golf course water quality management. All control measures will be the same as those included in the final Arroyo Trabuco Golf Course Water Quality Management Plan, or will provide equivalent control.

The following site design controls will be implemented:

*Rough Buffer Zones:* Rough areas will serve as buffer strips to separate the fairways, greens, and tees from native vegetation and nearby stream channels. The rough will be maintained at a height of cut higher than the fairways, greens, and tees. The rough buffer zone will disperse stormwater runoff energy and will aid in erosion and sedimentation control, as well as providing treatment control of pesticides and nutrients.

*Greens:* Greens will be constructed with a layered soil profile according to the United States Golf Association or similar specifications. This layered soil profile allows for water to be retained and held near the root zone, which conserves moisture and nutrients for the purposes of maintaining and promoting root growth and vigor while minimizing the loss of nutrients to groundwater. Excess water will be drained away from the root zone to a tile drainage system consisting of gravel and piping beneath the surface of the green. Flows in the sub-drains will be routed to non-domestic water supply reservoirs for recycling as irrigation water or may be directed to a nearby wastewater treatment plant for reclamation.

*Fairway and Bunker Drainage:* Fairway and bunker drainage will be directed to water features (e.g., lakes and ponds) designed for flow control, treatment and/or infiltration; bioinfiltration swales; or buffer strips.

The following source controls will be implemented.

*Outdoor Storage Area Design* - hazardous materials with the potential to contaminate urban runoff will either be: (1) placed in an enclosure such as, but not limited to, a cabinet, shed, or similar structure that prevents contact with runoff or spillage to the stormwater conveyance system; or (2) protected by secondary containment structures (not double wall containers) such as berms, dikes, or curbs on a paved surface and under cover.

*Cart Wash Areas* - areas for washing golf carts will be located inside the cart barn building. The floor area will be paved with Portland cement concrete, bermed around the perimeter and covered, preventing wash water from contacting stormwater runoff. Wash water will be drained directly to the sanitary sewer.

*Equipment Wash Areas* – equipment wash areas, located in the maintenance yard, will be paved with Portland cement concrete, bermed, fenced, and covered to protect the area from rainfall and overspray from leaving the area. Wash water will be drained directly the sanitary sewer.

*Fueling Areas* - Fuel dispensing areas will be located in the maintenance yard and will contain the following:

1. At a minimum, the concrete fuel dispensing area will extend 6.5 feet from the corner of each fuel dispenser, or the length at which the hose and nozzle assembly may be operated plus 1 foot, whichever is less.
2. The fuel dispensing area will be paved with Portland cement concrete (or equivalent smooth impervious surface). Asphalt concrete will not be used.
3. An appropriate slope (2% - 4%) will be provided to prevent ponding, and will be separated from the rest of the site by a grade break that prevents stormwater run-on.
4. An overhanging roof structure or canopy will be provided. The cover's minimum dimensions will be equal to or greater than the area within the grade break. The cover will not drain onto the fuel dispensing area and the downspouts will be routed to prevent drainage across the fueling area. The fueling area will drain to a spill control device prior to discharging to the stormwater conveyance system.

*Wash Water Control for Food Preparation Areas* – food preparation areas in restaurants will have either contained areas and/or sinks, each with sanitary sewer connection for the disposal of wash waters containing kitchen and food wastes.

*Irrigation Controls and Management:* Irrigation controls and full time irrigation management will ensure that irrigation is conducted efficiently. Efficient irrigation systems reduce irrigation runoff and conserve water resources; such systems may include computerized and/or radio telemetry that controls the amount of irrigation based on soil moisture or other indicators. Considering that irrigation in semi-arid areas generally exceeds mean annual precipitation, irrigation control is one of the most effective traditional controls for low flow runoff.

*Pesticide and Fertilizer Management:* Pesticide and fertilizer management will follow the guidelines for Integrated Pest Management (IPM) as outlined in the Orange County Management Guidelines for Use of Fertilizers (DAMP Section 5.5). IPM is an ecosystem-based strategy that focuses on long-term prevention of pests or their damage through a combination of techniques such as biological control, habitat manipulation, modification of cultural and mechanical practices, and use of resistant varieties. Pesticides are used only after monitoring indicates they are needed according to established guidelines, which may include damage threshold exceedance. Treatments are made with the goal of removing only the target organism. Pest control materials are selected and applied in a manner that minimizes risks to human health, beneficial or non-target organisms, and the environment.

The following runoff treatment control BMPs will be implemented on the golf courses:

*Clubhouse Runoff:* Dry weather flows and wet weather stormwater runoff from commercial areas (e.g. the clubhouse and associated parking lots) will be treated in biofiltration swales or planter boxes in the landscaped areas before discharging into the storm drain system. Parking lots will be swept at least weekly to remove coarse sediment and debris.

*Cart Storage and Maintenance Buildings:* Dry weather flows from these areas will be routed to the sanitary sewer. Stormwater runoff will be pretreated with catch basin insert prior to entering the storm drain system. All storm drain flows will receive treatment in a combined control system located within the golf course.

#### **4.1.4 Stormwater BMP Operation and Maintenance Program**

The Local WQMP requires that project WQMPs identify the mechanisms by which long-term operation and maintenance of all structural BMPs will be provided. This section outlines a general stormwater BMP operation and maintenance program.

##### ***Objectives***

The objectives of the operation and maintenance program are:

1. To optimize combined control system performance and the management of flows and water quality leaving the system.
2. To minimize adverse environmental impacts from maintenance activities.

Proposed maintenance activities are described below. Maintenance activities may be modified over time as experience is gained. Substantive modifications to the maintenance program will be made only with County of Orange approval.

### ***Maintenance Responsibility***

Home Owners Associations (HOAs) or another designated entity will be responsible for the inspection and maintenance of structural BMPs.

### ***General Operation and Maintenance Activities***

A standard operations and maintenance program is described below. The categories of operation and maintenance activities are “routine” and “major”. Each category and its respective activities are described in the following sections. Table 4-4 indicates the types of activities that are typically performed on the different BMP components (e.g., basins, mechanical equipment, access roads/paths). Each of the facilities will be operated and maintained with some variations from the standard program as appropriate for each site.

At some BMP facility sites, measures will be taken to limit potential impacts on sensitive species from the standard maintenance activities. These “minimization measures” will include avoidance of the nesting seasons for special status avian species to the extent feasible.

**Table 4-4: Typical Operation & Maintenance Activities**

	Combined Control System Component						Probable Average Frequency
	Basins	Swale	Vegetation	Inlet/Outlet	Mechanical Equipment (where applicable)	Access Roads/Paths	
<b>Routine Operation and Maintenance</b>							
Site Inspection	X	X	X	X	X	X	Monthly
Trash/Debris Removal	X	X	X	X	X	X	Quarterly
Pump/Valve Inspection, Adjustment & Maintenance				X	X		Monthly
Irrigation System Inspection & Adjustment			X		X	X	Monthly
Inlet/Outlet Inspection & Maintenance			X	X			Monthly
Minor Vegetation Removal/Thinning	X	X	X	X		X	Quarterly
Snag Removal	X	X	X	X			Monthly
Minor Sediment Removal	X	X	X	X		X	Quarterly
Integrated Pest/Plant Management	X	X	X	X		X	Weekly* (seasonal)



	Combined Control System Component						Probable Average Frequency
	Basins	Swale	Vegetation	Inlet/Outlet	Mechanical Equipment (where applicable)	Access Roads/Paths	
<b>Major Maintenance</b>							
Structural Modifications	X	X	X	X	X	X	As needed; infrequent
Pump/Valve Removal & Replacement				X	X		3-5 years
Major Vegetation Removal/Planting	X	X	X	X		X	1-5 years
Major Sediment Removal	X	X	X	X		X	1-5 years or longer

\* These operations will only be performed if needed; weekly is expected to be the maximum frequency.

### ***Routine Operation and Maintenance Activities***

Routine operation and maintenance activities are summarized in Table 4-4. A maintenance checklist for each facility will be developed and all routine maintenance activities will be recorded in a maintenance log. The various activities are described below.

#### ***Site Inspection***

All combined control system sites will be inspected on a regular, scheduled basis to ensure that the sites are operating properly, to record observations, and to initiate any actions that may be required, including those discussed below. While the frequency of site inspections may vary depending on the type of site and season, it will typically be on a monthly basis. During the break-in period and during the wet season, more visits may be required to collect data, record observations and make adjustments to equipment and control structures (weir heights, valves, etc.).

#### ***Trash & Debris Removal***

Litter may be picked up at any time during site visits for other purposes. Regular, scheduled trash/debris removal will be performed at all sites on a quarterly basis and/or after storm events that result in heavy trash accumulations. In constructed wetland areas, care will be taken to avoid damage by the crew or equipment to plants or other areas that may be used as incidental habitat.

### *Pump/Valve Inspection, Adjustment & Maintenance*

Some sites will require the use of pumps, valves and other mechanical equipment. Such equipment requires regular, scheduled preventive maintenance and adjustment. Emergency repairs may also be required. Routine work would typically be performed in conjunction with the monthly site inspections.

### *Irrigation System Inspection & Adjustment*

Some combined control system sites may require temporary or permanent irrigation systems for transitional vegetation areas or other non-wetland areas of the properties. At these sites, the irrigation system will be inspected and adjusted during the regular, scheduled site inspection by the site inspector.

### *Minor Vegetation Removal/Thinning*

Vegetation growth at inlets and outlets, in each FD/WQ basin, and in vegetated swales will be inspected annually, and removed or thinned as necessary. Vegetation at inlets and outlets will be manually or mechanically removed if vegetation is found to be clogging or otherwise affecting the operation of the facility. Access roads will remain clear of vegetation and obstructions. Fruit and nut trees will not be permitted on the facility sites to limit rodent food supply. Vegetation removal will generally be conducted in the summer and fall to avoid impacts on wildlife. Significant vegetation removal is covered under the major maintenance activities section below.

### *Snag Removal*

This work typically includes the removal of sticks, dead branches, brush, and small trees that block water flow or otherwise interfere with the operation of the sites.

In the basins, the work also includes the removal of bushes and small trees that interfere with the natural water quality treatment or water storage aspects of the basins. This work may be performed as needed on a quarterly basis.

### *Minor Sediment Removal*

It is expected that at some sites there will be a minor amount of sediment deposition at points within the basins, primarily at inlet flow spreaders and in forebays near the inlet(s). When such deposits obstruct water flow, the deposits will be removed.

### *Integrated Pest/Plant Management*

Although the basins in the combined control system will be designed to prevent standing water to the extent feasible, any natural environment is susceptible to harmful insect invasion. Whether harmful to property, person, or wildlife, some insects will need to be managed. Management may include measures from taking no action to using natural predators to chemical

or biological spraying. Some methods that are more natural include intermittent flooding and drying, vegetation thinning, and installation of “swallow boxes” and “bat boxes” to attract more swallows and bats, both of which feed voraciously on mosquitoes.

While more natural methods will be the methods of choice, it may be necessary at times to use sprays. Any application of chemical or biological agents will be performed by certified pesticide applicators in accordance with manufacturer recommendations and applicable laws and regulations. Maintenance activities for the control of mosquitoes may entail the application of *Bacillus thuringiensis israeliensis* (Bti), a natural microbial pesticide.

Undesirable vegetation, especially non-native invasive plant materials, will typically be removed on a quarterly basis, although occasionally more frequent removal may be required to prevent establishment of undesirable seed banks or other propagation means. In constructed water quality wetlands areas, care will be taken to avoid damage by the crew or truck to plants or other areas that may be used as incidental habitat. While this work is not expected to have any negative impacts on wildlife, such work will be conducted in accordance with any minimization measures established by the wildlife agencies.

### ***Major Operation and Maintenance Activities***

Major operation and maintenance activities are summarized in Table 4-4. All major maintenance activities will be recorded in maintenance logs.

### ***Structural Modifications***

Structural modifications may be required at the sites as part of the adaptive management approach. The purposes of such modifications could include improvement of combined control system performance, upsizing or downsizing of facilities, or improvement of uses such as flood control. Plans for structural modifications will be submitted to appropriate regulatory agencies in compliance with permit requirements.

### ***Pump/Valve Removal & Replacement***

Any pipeline, mechanical, or electrical equipment installed for a combined control system facility will have expected useful lives of 1 to 50 years. As a result, at some point in time all equipment will need to be removed and replaced or upgraded. To the extent practical, such work will be scheduled outside nesting seasons of species of concern. However, it is possible that emergency removal/ replacement may be required if such equipment fails suddenly.

### ***Major Vegetation Removal & Planting***

During the establishment period for wetland species within the FD/WQ basins, there may be a need for replacing or replanting species in order to achieve the desired mix and density of wetland plants, or to replace plants disturbed by maintenance activities.

Wetland vegetation near inlets and at random locations within the wetlands will be tested and monitored for accumulation of pollutants, similar to sediment monitoring activities. If elevated pollutant levels are detected, the need for plant harvesting to reduce potential exposure to wildlife will be evaluated and performed if deemed necessary. Harvesting typically entails cutting the stalks of the wetland plants to remove edible parts of the plant, and to enhance pollutant volatilization from the roots. Disposal of harvested plants shall be in accordance with appropriate regulations and levels of pollutants.

To the extent practical, basins will be configured to allow “rotational” vegetation removals. That is, portions of the basin/vegetation will be left undisturbed during vegetation removal. On subsequent cycles, the disturbed and undisturbed areas will be “rotated.” This allows for continuous retention of runoff within basins and allows wildlife to move to undisturbed areas while maintenance activities proceed in other areas.

### *Major Sediment Removal*

Most FD/WQ basins will be designed with a forebay or other sediment trapping area just downstream of their inlets. These areas are designed as sediment “traps” where coarser sediments and gross pollutants will accumulate. Sediment accumulation will be monitored annually prior to the wet season. Sediments will be removed when accumulations approach about 25 percent of the designed forebay volume.

Where practical, sediment removal will be performed in conjunction with major vegetation removal/replacement using the same impact avoidance schedules/techniques as appropriate. However, sediment removal will be scheduled based on the amount of accumulation and/or the character of the sediment. Although pollutant accumulation in basin sediments is not expected to meet hazardous waste levels, sediments will be tested for pollutant levels prior to removal. Sediment disposal will follow appropriate regulations in accordance with detected levels of pollutants.

## **4.2 WQMP FOR THE CAÑADA CHIQUITA SUB-BASIN**

### **4.2.1 Site Assessment**

Cañada Chiquita is located in the San Juan Creek watershed (Figure 4-1). Cañada Chiquita is the last major tributary to San Juan Creek before its confluence with Trabuco Creek, near Mission San Juan Capistrano. The sub-basin area as delineated for the WQMP encompasses 6.6 square miles, including a catchment (Catchment 18) that drains directly to San Juan Creek (Figure 4-2). The sub-basin is aligned north-to-south and ranges in elevation from 1,168 ft (MSL) in the north to 154 ft (MSL) in the south. Elevation differences from the top of the ridge to the canyon floor gradually increase southward in the sub-basin, reaching a maximum of approximately 500 feet (PCR et al, 2002).

The Cañada Chiquita Sub-basin is underlain by bedrock of the Monterey, San Onofre, Topanga, Sespe, and Santiago formations. The lower portion of the sub-basin is underlain primarily by the Santiago formation.

The surficial geologic units within the sub-basin consist of alluvium, colluvium, nonmarine terrace deposits, and landslide deposits. Several large bedrock landslide complexes occur along and adjacent to the Cristianitos fault system, particularly west of the fault zone. These larger landslides are located within the southwestern one-third of the sub-basin and appear to have failed along weak, sheared bedrock associated with the Cristianitos fault system.

Cañada Chiquita is one of the few naturally perennial streams in the watershed and contains riparian habitat, freshwater and alkaline marsh, and slope wetlands (PCR et al, 2002). The relatively high proportion of permeable soils and low percentage of developed area result in relatively low runoff and sediment yields of the sub-basins in the watershed. Many of the lateral tributaries are channel-less swales.

Below the “narrows” in middle Cañada Chiquita, soils are predominately sands, silts, and clays. Above the narrows, the soils contain slightly more gravels and cobbles. The sandy substrates cause the main creek to be prone to incision under altered hydrologic conditions. Several active head cuts are present in Chiquita Creek, and the channel is presently incising in several locations. Layers of cohesive silts and clays inferred as lake deposits formed upstream of the more elevated valley fill of San Juan Creek, and create a groundwater barrier that helps support perennial flows in Cañada Chiquita (PCR et al, 2002).

The perennial stream in Cañada Chiquita supports wetland vegetation in some areas. Little native vegetation remains on the valley floor beyond the riparian zone.

The mainstem creek supports herbaceous riparian, southern willow scrub, arroyo willow riparian forest, and coast live oak riparian forest habitats that support the least Bell’s vireo and several other sensitive riparian and aquatic species, including yellow-breasted chat, yellow warbler, southwestern pond turtle (near the confluence with San Juan Creek), western spadefoot toad, and two-striped garter snake (NCCP/SAMP Working Group, 2003b). The slopes and ridges adjacent to the main creek are dominated by coastal sage scrub that supports a major population of California gnatcatcher, both within the Southern Subregion and within the range of the gnatcatcher in southern California. The sub-basin provides breeding and/or foraging habitat for a variety of other sensitive wildlife species.

### ***Existing Development in Cañada Chiquita***

Cañada Chiquita is relatively undeveloped, including the Upper Chiquita Canyon Conservation Area and the Ladera Land Conservancy (open space on Chiquita ridge associated with the Ladera Ranch). Two existing developed areas are a publicly owned wastewater treatment plant in the lower canyon and the Tesora High School in the middle of the sub-basin (Figure 4-1).

Portions of the sub-basin have been used historically and are currently used for agriculture and grazing.

***Proposed Development in Cañada Chiquita***

Alternatives B-4 and B-9 cover approximately 2,730 acres in Cañada Chiquita (Figure 4-2 and Table 4-5) within Planning Area 2. Catchment 18 depicted on Figure 4-2 drains directly into San Juan Creek, but has been included in the Cañada Chiquita analysis. Under the B-4 Alternative, approximately 2,068 acres would remain as open space, with the remaining 663 acres being developed. The Alternative B-4 grading plan calls for 13 acres of the Chiquita Sub-basin to be regraded to drain toward Gobernadora Creek, while 16 acres of the Gobernadora Sub-basin would be graded to drain towards Chiquita Creek, for an overall gain of approximately 3 acres in the Chiquita Sub-basin. The proposed development occurs in the middle and lower portion of the sub-basin and primarily east of Chiquita Creek.

Under the B-9 alternative, the proposed development area is reduced to 309 acres in the lower portion of the sub-basin, with the remaining area reserved as open space.

**Table 4-5: Project Land Uses and Areas in the Chiquita Sub-basin**

<b>Alternative</b>	<b>Land Uses</b>	<b>Land Use Area within the Chiquita Sub-basin (acres)<sup>1</sup></b>
B-4	Golf Course	113
	Golf Residential	211
	Proposed Development	339
	Open Space	2068
	<b>TOTAL</b>	<b>2731</b>
B-9	Proposed Development	309
	Open Space	2423
	<b>TOTAL</b>	<b>2732</b>

<sup>1</sup>Land use area within the pre-development sub-basin boundary.

**4.2.2 Planning Considerations and Planning Recommendations for Cañada Chiquita**

In addition to the general Local WQMP requirements summarized in Section 4.1.1, the WQMP has been developed based on sub-basin specific water quality and hydrologic issues as identified in the *Draft Watershed and Sub-basin Planning Principles* (NCCP/SAMP Working Group, 2003a). Specific hydrologic planning considerations for Cañada Chiquita include:

- Main canyon and side canyon terrains are primarily sandy or silty sand and the sub-basin generally has high infiltration capacity.

- Side canyons (particularly east of the creek) contain deep sandy deposits and serve important hydrologic functions through infiltrating low volume storms to groundwater and high volume storms to the main stream channel.
- Ridges on the east side of the valley are characterized by rock outcroppings and areas of hardpan which are remnants of claypans formed in the geologic past that have eroded to form mesas, and locally steep slopes. These areas have minimal infiltration and channel flows into the major side canyons.
- The sand substrates beneath the tributary swales make them prone to incision under existing and altered hydrologic regimes.
- Based on comparisons with 1938 aerial photographs, the main creek channel has been relatively stable over the last 60 years. The deepening of the creek channel in portions of the mainstem of Chiquita Creek may be a result of long-term, gradual geologic processes, terrains, land use, or a combination of factors. The current channel bed elevation may be somewhat stabilized by pre-historic cohesive lake-bed or quiet-water sediments.
- Groundwater derived from beneath the hill slopes and ridges is a major source of water contributing to the perennial nature of the creek system. Inferences have been drawn indicating that water levels in the alluvium below Chiquita Creek are in large part isolated from those in the sands and gravels beneath San Juan Creek by a sub-surface barrier to groundwater movement into San Juan Creek.
- The sub-basin provides some of the lowest predicted sediment yields and transport rates of the sub-basins in the San Juan watershed, except during extraordinary episodic events, when large volumes of coarse sediment may be mobilized and transported to San Juan Creek.
- Relative to Gobernadora Creek and lower Gabino Creek, the area of floodplain connection is fairly limited. The hydrologic connections, both surface and subsurface, to the main side canyons appear to be more important in hydrologic terms than the floodplain connection.
- The combination of perennial flow in Chiquita Creek and subsurface water movement in Chiquita Canyon support riparian habitats, freshwater and alkaline marsh, and slope wetlands.
- Many of the slope wetlands on the east side of the valley appear to be sustained by large volumes of stored groundwater within the Santiago (and to a lesser extent the Sespe) formations that move along low permeability silt beds and discharge at breaks in the slope. The slope wetlands on the west side of the valley are sustained by fairly localized recharge of San Onogre breccia and derivative landslide deposits.

The selection and sizing of the facilities in the combined control systems for the Chiquita Sub-basin was guided by site conditions, the type of development land use, and incorporation of the planning recommendations. Table 4-6 lists the planning recommendations for Cañada Chiquita set forth in the *Draft Watershed and Sub-basin Planning Principles* and how the recommendations affected the choice and configuration of the combined control systems.

**Table 4-6: Incorporation of the *Planning Recommendations* into BMP Selection for Cañada Chiquita**

Planning Recommendations	Site Planning and Treatment/Flow Control BMPs
<ul style="list-style-type: none"> <li>Protect the headwaters of Upper Chiquita Canyon.</li> </ul>	<ul style="list-style-type: none"> <li>No development planned for headwaters.</li> </ul>
<ul style="list-style-type: none"> <li>Avoid creating impervious surfaces in the sandy soils of the canyon floor. To the extent feasible, land uses in the major side canyons should be limited to primarily pervious surfaces in order to maintain infiltration.</li> </ul>	<ul style="list-style-type: none"> <li>Canyon floor is Habitat Reserve and pervious golf course.</li> <li>Maintain infiltration capacity in golf course areas.</li> </ul>
<ul style="list-style-type: none"> <li>Mimic existing terrains/hydrology by locating development on the ridges, which under present conditions have higher runoff rates and direct surface runoff flows to the permeable substrate of the major side canyons and along the valley floor.</li> </ul>	<ul style="list-style-type: none"> <li>Residential development is located primarily on the ridges.</li> <li>Route runoff from ridge areas to combined control systems located on side canyon floors, sized to preserve pre-development water balance and flow duration in the main stem channel.</li> </ul>
<ul style="list-style-type: none"> <li>Promote stormwater surface flow connectivity between the major side canyons and the main stream channel to maintain transient surface channel connections that occur following extreme rainfall events, without significantly changing connections during small storms.</li> </ul>	<ul style="list-style-type: none"> <li>Direct excess flows from detention basin to mainstem channel using vegetated swale in which hydraulic connectivity to mainstem will mimic pre-development condition, namely connectivity under large, but not small or moderate events.</li> </ul>
<ul style="list-style-type: none"> <li>Identify natural treatment systems for water quality treatment and stormwater detention that would be appropriate in the sandy soils of the major side canyons and the valley floor.</li> </ul>	<ul style="list-style-type: none"> <li>Combined control system consists of extended detention with low flow wetland treatment, infiltration, and vegetated swale connected to main stem channel.</li> </ul>
<ul style="list-style-type: none"> <li>Maintain groundwater recharge to the shallow subsurface water system to sustain flows to Chiquita Creek.</li> </ul>	<ul style="list-style-type: none"> <li>Incorporated infiltration basins to help mimic pre-development recharge and runoff volumes. Pre-treat water to be infiltrated in FD/WQ basin to protect groundwater quality.</li> </ul>
<ul style="list-style-type: none"> <li>Address existing areas of channel incision that result from primarily localized processes/land use practices, as contrasted with terrace-forming valley-deepening areas that are primarily a result of long-term geologic conditions. Site by site geomorphic analysis will be undertaken to define these areas.</li> </ul>	<ul style="list-style-type: none"> <li>Refer to the Habitat Restoration Plan contained in Technical Appendix J-2 of the Ranch Plan EIR.</li> <li>New development will not exacerbate existing channel incision.</li> </ul>



Planning Recommendations	Site Planning and Treatment/Flow Control BMPs
<ul style="list-style-type: none"> <li>To the maximum extent practical, avoid direct impacts to the slope wetlands and maintain primary recharge characteristics that support these wetlands.</li> </ul>	<ul style="list-style-type: none"> <li>Slope wetlands will be avoided.</li> <li>Infiltration incorporated within ridge developments to help sustain pre-development infiltration and slope wetlands.</li> </ul>

### 4.2.3 **Combined Control System: Elements and Sizes by Catchment**

Although the specific types of developments have yet to be determined, the following mix of development types are likely and the following describes how the proposed combined control system might be configured for each type of development for the B-4 alternative.

#### ***Golf Course Residences***

Golf Course residences may be located on the ridges along the east side of the canyon. The ridges contain substantial areas of hard pan caps, which combined with geotechnical considerations for slope stability, limit the feasibility of infiltration. To restrict infiltration, lined bioswales with an underdrain will be located along streets and driveways. The swale system will direct wet and dry weather flows to an engineered conduit that will carry water down the slope to the side canyons, or if required by grade considerations, to the main canyon floor. In the canyons, water will be directed to a combined control system. The combined control system will consist of three major elements: a FD/WQ basin, a separate infiltration basin or series of infiltration basins, and a vegetated bioinfiltration swale. The FD/WQ basin will store and treat wet and dry weather flows using natural treatment processes. The outlet structure will be designed to direct low flows to an infiltration basin to take advantage of the infiltrative soils in the side canyons and in the main canyon floor. Higher flows will be directed to a vegetated swale that will connect to the main stem of Chiquita Creek. Depending on topographic and grade considerations, the combined control system facilities will, to the extent feasible, be located near the head end of the side canyons where depth to groundwater is greatest.

#### ***Single Family Residential Development***

The concept for controlling flow and water quality for the single family residential development is different than that for the less dense golf course residences. A series of vegetated swales within the development will direct flows to a FD/WQ basin located on the canyon floor. In order to avoid increasing base flows in lower Chiquita Creek, infiltration will not be implemented. Instead the excess flows that would have been infiltrated will be directed from the FD/WQ basin to either San Juan Creek, to non-domestic water supply reservoirs, or the wastewater treatment plant for treatment and non-potable water supply. (San Juan Creek, given its size and cobbly bed, is considered to be able to accept additional flows without causing erosion, and there are potential benefits to habitat and downstream water supply.) The higher flows will be directed from the FD/WQ basin to Chiquita Creek in a vegetated swale in order to maintain the

hydrologic regime in the stream channel. These flows will be treated in the FD/WQ basin and swale prior to discharge into San Juan Creek.

### ***Multifamily Development***

The combined control system proposed for multi-family residential areas would be slightly different than those proposed for golf course and single family residential development. For each catchment, the FD/WQ basin is sized to capture and treat the water quality design volume. Low flows are then directed to an infiltration basin and high flows are directed to Chiquita Creek in a bioinfiltration swale

In Catchment 9, where development is located on the canyon floor in sandy soils having good infiltrative characteristics, there are a number of site design BMP options that are not feasible in less infiltrative soils. Roof runoff could be directed to stormwater planter areas or bioinfiltration swales, and landscaped areas could be used to treat runoff from parking and courtyard areas. Street runoff and excess roof/parking area runoff would be directed to the combined control system described above.

### ***Golf Course***

Golf course water quality and flow controls will vary depending on the specific area under consideration as discussed below.

*Greens:* Greens will be constructed with a layered soil profile according to the United States Golf Association or similar specifications. This layered soil profile allows for water to be retained and held near the root zone, which conserves moisture and nutrients for the purposes of maintaining and promoting root growth and vigor while minimizing the loss of nutrients to groundwater. Excess water will be drained away from the root zone to a tile drainage system consisting of gravel and piping beneath the surface of the green. Flows in the sub-drains will be routed to non-domestic water supply reservoirs or water features (e.g., lakes or ponds) for recycling as irrigation water or may be directed to a nearby wastewater treatment plant for reclamation.. Surface runoff from greens is very limited because of the drainage system. However, what surface runoff does occur will be treated in a similar way to the water discharged from the sub-drains.

*Fairway and Bunker Drainage:* Fairway and bunker drainage will be directed to water features (e.g., lakes and ponds) designed for flow control, treatment and/or infiltration; bioinfiltration swales; or buffer strips.

### ***Facilities and Sizing***

The choice and size of facilities in the combined control systems for the Chiquita Sub-basin vary depending on the catchment, as illustrated in Table 4-7. For most catchments, the combined control system consists of a FD/WQ basin, a separate infiltration basin, and a vegetated swale.

**Table 4-7: Combined Control System Requirements for Cañada Chiquita- Alternative B-4**

Facility Id	Tributary Catchments	FD/WQ Basin	ED Basin	Infiltration Basin	Vegetated Swale		Direct Discharge to San Juan Creek	Non-domestic Water Supply Storage and Recycling	Comments
					Unlined	Lined			
Chiquita-2	2				✓			✓	Unlined swale provides adequate volume control and water quality treatment given limited runoff anticipated from golf course
Chiquita-3	3				✓			✓	Same as Chiquita-2
Chiquita-4	4				✓			✓	Same as Chiquita-2
Chiquita-5	5				✓			✓	Same as Chiquita-2
Chiquita-9	9		✓	✓	✓			✓	Combined control system designed to control and treat approximately 80-90% of excess runoff. Complete control infeasible given sandy soils and low pre-development runoff.
Chiquita-10	10	✓		✓	✓			✓	Standard combined control system. Water is conveyed from the flow duration basin to the infiltration basin through vegetated swales, providing further water quality treatment.
Chiquita-11	11	✓		✓	✓			✓	Same as Chiquita-10
Chiquita-12	12	✓		✓	✓			✓	Same as Chiquita-10
Chiquita-13	13	✓		✓	✓			✓	Same as Chiquita-10
Chiquita-14	14	✓		✓	✓			✓	Same as Chiquita-10
Chiquita-16/17 <sup>1</sup>	16/17	✓				✓	✓		Flow duration control required for discharge into Chiquita Creek. Excess flows are treated and discharged directly to San Juan Creek.
Chiquita-18	18		✓				✓		Discharge directed to San Juan Creek, no flow duration control required.

<sup>1</sup>Includes a small portion of Catchment 15.

Where flow duration control is not necessary, as in Catchment 18 that discharges directly to San Juan Creek, an extended detention (ED) water quality basin has been provided.

Table 4-8 shows the estimated sizes of the various facilities by catchment. In general, more volume control is required where the amount of impervious surface in the catchment is higher, as is the case in Catchments 16 and 17, and when development is placed on soils that are more infiltrative, as is the case of Catchment 9. Less volume control will be necessary for the less dense golf course residences which may be located on hardpan in catchments 10 through 14. The percent capture values indicated in Table 4-8 illustrate that the water quality treatment achieved in the system as a whole.

**Table 4-8: Combined Control System Facilities and Sizes in Cañada Chiquita- Alternative B-4**

Catchment Number	Facility Tributary Area <sup>1</sup> (acre)	F.D./W.Q. Basin			Infiltration Basin <sup>3</sup>		Vegetated Swale	
		% Capture <sup>2</sup>	Area (acres)	Volume (ac-ft)	Area (acres)	Volume (ac-ft)	Area (acres)	Volume (ac-ft)
2	10	-	-	-	-	-	0.3	0.8
3	17	-	-	-	-	-	0.5	1.3
4	26	-	-	-	-	-	0.4	1
5	9	-	-	-	-	-	0.6	1.6
9	59	85	1.6	4.6	1.2	2.6	-	-
10	18	89	0.8	0.9	1.0	1.9	-	-
11	37	96	0.1	0.1	1.1	2.3	-	-
12	58	96	0.2	0.4	2.4	4.7	-	-
13	46	94	1.6	4.6	1.2	2.4	1.0	1.0
14	44	88	1.1	4.2	0.5	0.9	-	-
16/17 <sup>4</sup>	144	88	1.8	7.2	-	-	-	-
18	67	91	1.2	4.1	-	-	-	-

<sup>1</sup>Tributary area includes project development within the catchment; open space and existing development are not included.

<sup>2</sup>Percent of average annual runoff volume predicted by model that is captured and detained for 48 hours in the basin.

<sup>3</sup>Infiltration basin sizes assume no infiltration occurs in vegetated swales. Infiltration basin areas may be reduced during final design by taking into account infiltration achieved in vegetated swales.

<sup>4</sup>Includes a small portion of Catchment 15.

## ***Combined Control System Elements – Alternative B-9***

Under the B-9 alternative, the proposed development area is reduced to 309 acres in the lower portion of the sub-basin. General development is proposed in Catchments 16 through 18 (Figure 4-2). The combined control system elements for Alternative B-9 would be identical to the elements identified in Tables 4-7 and 4-8 above for these catchments.

### **4.3 WATER QUALITY MANAGEMENT PLAN FOR THE CAÑADA GOBERNADORA SUB-BASIN**

#### **4.3.1 Site Assessment**

The 11.10 square mile Cañada Gobernadora Sub-basin is an elongated valley that is aligned north to south (Figure 4-3). Like the Chiquita Sub-basin, it is long and narrow and is characterized by deep alluvial deposits in the canyon floor (PCR et al, 2002). Sandy and silty substrates on many of the hill slopes and ridges in the sub-basin are overlain by several feet of exhumed hardpan or contain exposed rock outcrops. These ridge areas presently exhibit rapid runoff comparable to Class D soils.

Cañada Gobernadora contains some of the highest potential infiltration areas in the study area. This is especially true in the valley floor, which is characterized by deep alluvial deposits with interbedded clay lenses. In the valley floor, many of the tributaries are channel-less swales. These areas represent high infiltration zones that likely convey stream runoff to the main-stem of Gobernadora Creek and only exhibit surface connection following extreme runoff events. These infiltration zones may also contribute to base flow and the perennial nature of Gobernadora Creek.

Depth to groundwater data reported by Balance Hydrologics for the spring of 2003 vary from 35 feet in some of the upper portions of the canyons to 5 to 10 feet in the riparian corridor. Depths are less in areas near the mouth of the canyon, where inferred lake bed deposits block groundwater outflow.

Cañada Gobernadora is predominantly underlain by sands and silts and has the potential to generate relatively high amounts of sediment where the surface is disturbed and channelized. In recent years, natural sediment sources have been augmented by sediment runoff from graded slopes in the developing areas of the upper sub-basin (outside of the Project boundary). Much of the sediment generated from the upstream development in Coto de Caza deposits in the lower portion of the canyon, typically within the riparian zone.

This sub-basin is likely a significant source of nitrogen and phosphorus loadings from grasslands/agriculture, urbanization in the upper reaches with minimal use of BMPs, and the presence of large nursery operations. Conditions favor the transport of metals and pesticides in particulate form.

### ***Existing Land Uses***

There is extensive existing urban development in Upper Gobernadora, which constitutes about the upper two-thirds of the sub-basin and is outside of the RMV boundary (Figure 4-4). The development is referred to as Coto de Caza and includes primarily single and multi-family residential housing. Some residential development is also located in Wagon Wheel Canyon which flows into Gobernadora Creek just downstream of Coto de Caza. The hydrologic effects of runoff from Coto de Caza and Wagon Wheel have been considered in the hydrologic analysis. There is also some agricultural development in the form of nurseries in the extreme southern portion of the sub-basin.

The Santa Margarita Water District and RMV are jointly considering the Gobernadora Multi-purpose Modulation Basin project which calls for the installation of a multi-purpose control facility along Gobernadora Creek, downstream of its confluence with Wagon Wheel Creek. Water stored in the facility would be pumped to non-domestic water supply reservoir(s) owned by SMWD where the water would be utilized for irrigation purposes. It is anticipated that the project would help to reduce excessive flows and sediment discharges to lower Gobernadora, provide a higher quality of water to lower Gobernadora Creek and San Juan Creek, and provide an additional source of non-domestic water supply. Infiltration and flow duration control planning will need to address alternative future “with” and “without” Multipurpose Modulation Basin scenarios.

### ***Future Land Uses***

The development alternatives in Cañada Gobernadora addresses approximately 2,194 acres within Planning Areas 2 and 3 (Figure 4-4 and Table 4-9). Under the B-4 Alternative, approximately 1,078 acres would remain as open space, with the remaining area being developed into estates; single, multi-family, and golf residential housing; and transportation. Alternative B-4 grading plans call for approximately 39 acres of the sub-basin to be graded into the Central San Juan Sub-basin and approximately 16 acres into the Chiquita Sub-basin, while 16 acres of the Central San Juan Sub-basin and 13 acres of the Chiquita Sub-basin would be graded into the Gobernadora Sub-basin. Overall, the area of the Gobernadora Sub-basin would be reduced by approximately 26 acres. Residential development is planned to be located in Planning Area 2 (the eastern portion of Lower Gobernadora Canyon) and in Planning Area 3 (the western portion of Lower Gobernadora Canyon), while the riparian area and central portion of the valley floor is part of the Gobernadora Ecological Reserve Area.

Under the B-9 alternative, 1,138 acres would remain as open space while the 1,037 acres is developed as general development. The footprint of Alternative B-9 within the Gobernadora sub-basin is similar to the B-4 alternative, although slightly smaller (1,037 acres of general development in Alternative B-9 versus 1,098 acres of estates and general development land uses in Alternative B-4).

**Table 4-9: Land Uses and Areas in Cañada Gobernadora**

Alternative	Land Uses	Land Use Area within the Gobernadora Sub-basin (acres) <sup>1</sup>
B-4	Estate	140
	Golf Residential	25
	Proposed Development	933
	Open Space	1077
	TOTAL	<b>2,175</b>
B-9	Proposed Development	1,037
	Open Space	1,138
	TOTAL	<b>2,175</b>

<sup>1</sup>Land use area within the pre-development sub-basin boundary.

#### **4.3.2 Planning Considerations and Planning Recommendations for Cañada Gobernadora**

Specific hydrologic planning considerations for Cañada Gobernadora set forth in the *Draft Watershed and Sub-basin Planning Principles* the include:

- Cañada Gobernadora contains some of the highest potential infiltration areas in the study area, particularly in the valley floor which is characterized by deep alluvial deposits with interbedded clay lenses. However, high groundwater levels may affect the overall infiltration capacity of the sub-basin.
- Total runoff in Cañada Gobernadora is proportionately higher than other sub-basins, due to the size, elongated shape, and amount of existing development in the upper portion of the watershed.
- The hill slopes and ridges in the sub-basin exhibit areas of exhumed hardpan overlying sandy and silty substrates (the eroded remnants of claypans formed in the geologic past) or contain exposed rock outcrops or other areas of steep slopes. These areas presently exhibit rapid runoff comparable to Class D soils, although having less soil moisture storage they likely generate runoff with most storms.
- Due to the elongated configuration and the predominance of sandy terrains in the Gobernadora Sub-basin, first order streams are proportionally less of the total stream length than in several other sub-basins. Many of the tributaries consist of channel-less swales. These swales likely convey a combination of surface and subsurface flow to the main-stem creek and may exhibit surface connection following extreme runoff events.
- Historic photos indicate that the mainstem creek meandered freely across the valley floor over most of the length of the valley downstream from the mouth of Wagon Wheel Canyon.

- Groundwater derived from beneath the hill slopes and ridges is a major source of water contributing to the perennial nature of the creek system. Inferences have been drawn indicating that water levels in the alluvium below Cañada Gobernadora are at least in large part isolated from those in the sands and gravels beneath San Juan Creek. The perennial nature of the creek in its upper reaches is likely influenced primarily by urban runoff from upstream development, while perennial flow in the lower portion of the creek is influenced by a combination of urban runoff, increased recharge from upstream areas, and lateral subsurface inflow to the valley floor.
- High sediment yields are currently generated from the already developed, disturbed upper portion of the sub-basin and have been deposited in the flats below Coto de Caza, where flows from Wagon Wheel Canyon enter the sub-basin. In 2001, the creek moved out of its previous channel in this location, cut a new channel (i.e., avulsed) and resulted in downstream deposition of sediments.
- Emergent marsh habitat, including alkali wetlands, and willow habitats are present in the GERA wetlands restoration area, with a mix of southern willow riparian and sycamore-willow woodland areas upstream to the boundary of Coto de Caza.

The selection and sizing of the facilities in the combined control systems for the Gobernadora Sub-basin were guided by site conditions (including surface and subsurface flows from existing upstream development), the type of development land use, and incorporation of the planning recommendations. Table 4-10 lists the planning recommendations for Cañada Gobernadora set forth in the *Draft Watershed and Sub-basin Planning Principles* and how the recommendations affected the choice and configuration of the combined control systems.

**Table 4-10: Incorporation of the *Planning Recommendations* into BMP Selection for Cañada Gobernadora**

Planning Recommendations	Site Planning and Treatment/Flow Control BMPs
<ul style="list-style-type: none"> <li>• Protect Cañada Gobernadora valley floor above the knickpoint to provide for creek meandering (as occurred historically) and for restoration of riparian processes and habitat.</li> </ul>	<ul style="list-style-type: none"> <li>• Proposed development protects the valley floor above the knickpoint to allow for restoration of the creek meander and also includes a wide open space corridor along Gobernadora Creek.</li> </ul>
<ul style="list-style-type: none"> <li>• In order to emulate current hydrologic patterns, development areas should be set back from the valley floor and focus on areas that presently manifest Class D soils runoff characteristics, including those areas with existing hardpan caps.</li> </ul>	<ul style="list-style-type: none"> <li>• A major portion of proposed development will be located in ridge areas where there are less infiltrative soils and hardpan caps.</li> </ul>
<ul style="list-style-type: none"> <li>• Deep alluvial deposits that function as important infiltration/recharge areas underlie the valley floor and adjacent tributary swales. At the same time, any changes in future stormwater flows to these areas may need to be accompanied by</li> </ul>	<ul style="list-style-type: none"> <li>• The combined control system is intended to be located to the extent feasible in upper portions of side canyons where depth to groundwater is greatest.</li> <li>• The combined control system will result in</li> </ul>



<b>Planning Recommendations</b>	<b>Site Planning and Treatment/Flow Control BMPs</b>
<p>groundwater management due to limited infiltration capacity resulting from high groundwater levels.</p>	<p>infiltration being distributed over a fairly large area, which will help prevent localized high perched water.</p> <ul style="list-style-type: none"> <li>• Stormwater flow management will include provisions for capturing flows in excess of existing conditions for use in development area irrigation and provisions for routing flows to San Juan Creek in the lower sub-basin.</li> <li>• The use of non-domestic water supply reservoirs for storing water that could be recycled for irrigation would be an alternative to infiltration basins that would result in less infiltrated water.</li> </ul>
<ul style="list-style-type: none"> <li>• Given the size of the valley floor, there are opportunities for creating natural treatment systems to treat potential existing and future urban runoff from the Gobernadora Sub-basin, as well as provide opportunities for expanded wetland habitat areas.</li> </ul>	<ul style="list-style-type: none"> <li>• The combined control system employs natural treatment processes including the utilization of low flow wetlands treatment in the flow control/water quality basin, bioinfiltration swales, and infiltration basins.</li> <li>• The use of non-domestic water supply reservoirs to store water for irrigation is also a natural “land application” treatment alternative.</li> </ul>
<ul style="list-style-type: none"> <li>• Sediment management and creek restoration activities may be necessary in Lower Gobernadora Canyon to address the present excessive sediment input from upstream urbanized areas. The increased sediment resulting from upstream construction will likely be moving through the system for a prolonged period. Eventually, sediment loads may decrease due to buildout of the upper watershed. Consequently, floodplain restoration should account for both the existing and future sediment regimes.</li> </ul>	<ul style="list-style-type: none"> <li>• Refer to the Habitat Restoration Plan contained in Technical Appendix J-2 of the Ranch Plan EIR.</li> <li>• The proposed Gobernadora Multipurpose Basin* is intended to address excessive water flows, sediment and pollutant load from Coto de Caza.</li> </ul>
<ul style="list-style-type: none"> <li>• Existing channel incision that has isolated the Creek from the floodplain in some areas should be addressed as part of the restoration effort.</li> </ul>	<ul style="list-style-type: none"> <li>• Refer to the Habitat Restoration Plan contained in Technical Appendix J-2 of the Ranch Plan EIR.</li> </ul>
<ul style="list-style-type: none"> <li>• Protect the GERA and, to the extent feasible, minimize impacts to major riparian areas consistent with the overall restoration and management plan.</li> </ul>	<ul style="list-style-type: none"> <li>• The combined control system is designed to manage flows and water quality outside of the GERA. The quality and magnitude of surface and groundwater flows entering the GERA from the combined control system will mimic existing undeveloped conditions to the extent practicable.</li> </ul>

Planning Recommendations	Site Planning and Treatment/Flow Control BMPs
<ul style="list-style-type: none"> <li>In order to maintain the sediment transport functions of the central reach of San Juan Creek, the timing of peak flows in Cañada Gobernadora at the confluence with San Juan Creek should be managed to emulate existing conditions and avoid coincident peak flows with San Juan Creek.</li> </ul>	<ul style="list-style-type: none"> <li>The combined control system is designed to emulate existing hydrologic conditions, and therefore would mimic the existing timing of peak flows.</li> </ul>

\* The NCCP sub-basin restoration recommendations for the Gobernadora Sub-basin state: “Implement a restoration program in Gobernadora Creek which addresses...(2) upstream land use induced channel incision and erosion, including potentially excessive surface and groundwater originating upstream” (Policy 49) (This is the only policy addressing upstream flow management.)

### 4.3.3 Combined Control System: Elements and Sizes by Catchment

The following describes the proposed combined facilities for each type of development for the B-4 alternative.

#### *Estate Residences*

Estate residences will be located on the ridge along the east side of the canyon. This area is covered by extensive areas of hard pan caps which, combined with geotechnical considerations for slope stability, argue for avoiding infiltration on the ridges. Lined bioswales with an underdrain will be located along streets and driveways. The swale system will direct wet and dry weather flows to an engineered conduit that will carry water down the slope to the canyon floor. Runoff will be directed to a treatment train consisting of a FD/WQ basin and bioinfiltration swale prior to discharge to Gobernadora Creek. In Catchment 10, water quality treatment would be provided in an extended detention basin; no flow control is required as only about five acres of estate housing is proposed.

#### *Single Family Residential Development*

Residential development is planned to be located in the eastern and western portion of lower Gobernadora Canyon. The riparian area and central portion of the valley floor is reserved as open space in the Gobernadora Ecological Reserve Area (GERA). The concept for controlling flow and water quality calls for a series of vegetated swales within the development and a combined facility located on the side canyon or main canyon floor, outside of the GERA. If portions of the development are located in the side canyons, roof runoff may be directed to infiltration trenches, planter boxes or infiltrative swales. Although depth to groundwater generally decreases in Lower Gobernadora because of the effects of inferred lake bed deposits, data indicates that infiltration is feasible in this area. Infiltration and flow management issues relating to excessive surface and sub-surface water flows from upstream development area addressed in Chapter 5. Centrally located non-domestic water supply reservoirs also may be feasible in this development and could be used for recycling dry and low wet weather flows for irrigation of common landscape areas.

In the side canyons and on the canyon floor, runoff will be treated by a combined facility designed to provide water quality treatment and flow control. The facility will consist of three main elements: a flow duration and water quality treatment detention basin, a separate infiltration basin or series of infiltration basins, and a vegetated swale. The flow duration and water quality treatment basin will store and treat wet and dry weather flows using natural treatment processes. The outlet structure will be designed to direct low flows to a series of infiltration basins to take advantage of the infiltrative soils in the side canyons. Higher flows will be directed to a vegetated swale that will connect to the main stem channel. The facility will be located to the extent feasible near the head end of the side canyons where depth to groundwater is greatest.

### ***Facilities and Sizing***

The choice and size of facilities in the combined control system introduced in Chapter 3 vary depending on the catchment as illustrated in Table 4-11. For most catchments, the combined control system consists of a flow control/water quality basin, a separate infiltration basin, and a lined or unlined bioswale. Where flow duration control is not necessary, as in catchments that drain directly to San Juan Creek, an extended detention (ED) water quality basin has been provided.

Table 4-12 shows the estimated sizes of the various facilities by catchment. In general, more volume control is required where the development will be located on sandy infiltrative soils, and where the development is more urbanized. Less volume control will be necessary for less dense development, i.e., having lower percent imperviousness and located on less permeable soils.

For Alternative B-9, the proposed development is very similar to that proposed for Alternative B-4, except that the estate housing is replaced with a smaller area of general development. Therefore, the combined control system facilities would be similar to those proposed in Tables 4-11 and 4-12 below.

**Table 4-11: Combined Control System Requirements for Cañada Gobernadora- Alternative B-4**

Facility ID	Tributary Catchments	FD/WQ Basin	ED Basin	Infiltration Basin	Vegetated Swale		Direct Discharge to San Juan Creek	Storage and Recycling	Storage and Recycling
					Unlined	Lined			
Gob-1	1		✓			✓	✓		Water quality treatment only. No flow control assumed to be required as discharge directed to San Juan Creek.
Gob-3	3	✓		✓	✓				Standard combined control system. Water is conveyed from the flow duration basin to the infiltration basin through vegetated swales, allowing further water quality treatment.
Gob-4	4		✓			✓			Water quality treatment only because catchment has 85 acres of outcrops and change in runoff with development small.
Gob-5	5	✓		✓	✓				Same as Gob-3
Gob-7	7	✓		✓	✓				Same as Gob-3
Gob-8	8	✓		✓	✓				Same as Gob-3
Gob-9	9	✓		✓	✓				Same as Gob-3
Gob-10	10		✓						Water quality treatment only. No flow control required as only about 5 acres of estate housing.

**Table 4-12: Combined Control System Facilities and Sizes in Cañada Gobernadora-Alternative B-4**

Catchment Number	Facility Tributary Area <sup>1</sup> (acre)	F.D./W.Q. Basin			Infiltration Basin <sup>3</sup>	
		% Capture <sup>2</sup>	Area (acres)	Volume (ac-ft)	Area (acres)	Volume (ac-ft)
1	269	86	3.2	12	-	-
3	275	73	3.7	15	1.7	3.5
4	169	87	2.1	7.6	-	-
5	207	83	2.6	15	2.4	5.1
7	61	96	0.3	0.2	1.7	3.2
8	87	94	2.4	8	2.1	4.4
9	43	91	0.2	0.7	0.61	1.2
10	5	99	0.8	2.8	-	-

<sup>1</sup>Tributary area includes project development within the catchment; open space and existing development are not included.

<sup>2</sup>Percent of average annual runoff volume predicted by the model that is captured in the basin.

<sup>3</sup>Infiltration basin sizes assume no infiltration occurs in vegetated swales. Infiltration areas and volumes may be divided between infiltration basin and swales in detailed design, with consideration of maintaining flow durations.

#### **4.4 WATER QUALITY MANAGEMENT PLAN FOR THE CENTRAL SAN JUAN AND TRAMPAS SUB-BASIN**

##### **4.4.1 Site Assessment**

The Central San Juan and Trampas Canyon Sub-basin is divided into two main geographic areas: the Central San Juan subunit and the Trampas subunit (NCCP/ SAMP Working Group, 2003). The Central San Juan subunit includes the reach of San Juan Creek from just south of the confluence with Bell Creek to the east and the confluence with Gobernadora Creek to the west. The Central San Juan subunit extends north from San Juan Creek approximately 1.6 miles and encompasses a large north-south trending canyon through the center of the subunit. The Trampas Canyon subunit is characterized by the silica sand mining operation that dominates the canyon and the rugged terrain between Cristianitos Canyon and San Juan Creek. Planning areas that fall within the Central San Juan and Trampas Sub-basin include a portion of PA 3, all of PA 4, most of PA 5, and a limited number of estates associated with PA 9 (Figure 4-5).

The Central San Juan and Trampas Sub-basin covers a 7.4 square mile area that contains several small tributary drainages which feed directly into the main stem of San Juan Creek. The central

portion of the main stem of San Juan Creek, downstream of Bell, Lucas, and Verdugo Canyons, consists of a meandering river with several floodplain terraces in a wide valley bottom.

The Central San Juan and Trampas Canyon drainage basin is underlain by bedrock of the Santiago, Silverado, and Williams formations. Bedding within the bedrock of the Santiago, Silverado, and Williams formations is near horizontal to gently dipping. Surficial geologic units within the project boundaries consist of alluvium, colluvium, nonmarine terrace deposits, and a few landslides. The majority of the sub-basin area is underlain by soils of hydrologic groups C (52.6 percent) and D (29.2 percent).

The middle reach of the main stem of San Juan Creek is a broad, meandering stream with several floodplain terraces (PCR et al, 2002). The creek supports a mosaic of southern willow riparian woodland, mule fat scrub, open water, and sand bars. The adjacent terraces support coast live oak woodland and southern sycamore riparian woodland. The creek has relatively coarse substrate and high topographic complexity, with a variety of secondary channels, pits, ponds, and bars. An abandoned aggregate mining pit has been filling in over the last several years and supports an open water and emergent marsh community. The central portion of San Juan functions as a sediment conduit between the major sediment-producing sub-basins and downstream areas.

The combination of predominant grasslands, erodible soils, and anthropogenic sources such as the Color Spot nurseries means that the sub-basins can be expected to generate relatively large nitrogen and phosphorus loadings for their size and may be a contributor to the increases in nutrient concentrations between Caspers Regional Park and La Novia that is evident in the Orange County PFRD monitoring program. However, some of the constituents may be sequestered (at least seasonally) within the permeable alluvial aquifers of San Juan Creek. High loads of fine sediment and particulates should favor the adsorbed phases of heavy metals and pesticides.

The central portion of San Juan Creek has intermittent to near perennial flow that is supported by alluvial groundwater that is near the surface, at least seasonally. The riparian habitats and pool and ponds depend on sufficient duration of shallow groundwater. This groundwater is recharged from sub-basins higher in the watershed and is conveyed in the alluvium through the central portion of San Juan Creek.

### ***Existing Land Uses***

Agricultural and developed lands cover approximately 12 percent of the land in this sub-basin. The Color Spot nursery is located on the north side of San Juan Creek in Catchments 21 and 26. Groundwater pumping supports local citrus orchards. Sand, hard rock, and minerals have been mined from Trampas Canyon over the last 50 years. An artificial lake used in the ongoing mining operation dominates this portion of the sub-basin.

**Future Land Uses**

The development alternatives in the Central San Juan and Trampas Sub-basin address approximately 4,770 acres in a portion of PA 3, all of PA 4, most of PA 5, and a small portion of PA 9 (Figure 4-5, Figure 4-6, and Table 4-13). Under the B-4 Alternative, approximately 2,058 acres would remain as open space and 2,698 acres would be developed. The B-4 alternative grading plan for this sub-basin would redirect runoff from approximately 4 acres from Trampas Canyon into the Cristianitos Sub-basin and 16 acres into the Gobernadora Sub-basin, while runoff from approximately 30 acres of the Cristianitos Sub-basin, 40 acres of the Gobernadora Sub-basin, and 67 acres of the Lower San Juan Sub-basin would be redirected into the Central San Juan Sub-basin. Overall, the Central San Juan and Trampas Sub-basin would gain approximately 115 acres.

Under the B-9 alternative, 1,559 acres would remain as open space while 3,213 acres are developed. The proposed development in PA 3 is slightly less in Alternative B-9 within the Central San Juan/Trampas Sub-basin (approximately 10 acres). The proposed development in PA 4 is significantly different under the two alternatives. In Alternative B-4, 211 acres of estate housing is proposed, while Alternative B-9 includes 1,280 acres of general development within PA 4 in both the Central San Juan/Trampas and Verdugo Sub-basins. In addition, the B-9 alternative incorporates additional roadways linking PA 4 and PA 5.

**Table 4-13: Land Uses and Areas in the Central San Juan and Trampas Sub-basin**

Alternative	Land Uses	Land Use Area within the Central San Juan and Trampas Sub-basin (acres) <sup>1</sup>
B-4	Estate	230
	Golf Course	12
	Proposed Development	2,475
	Open Space	2,055
	<b>TOTAL</b>	<b>4,772</b>
B-9	Proposed Development	3,213
	Open Space	1,159
	<b>TOTAL</b>	<b>4,772</b>

<sup>1</sup>Land use area within the pre-development sub-basin boundary.

**4.4.2 Planning Considerations and Planning Recommendations for the Central San Juan and Trampas Sub-basin**

Specific hydrologic planning considerations for the Central San Juan and Trampas Sub-basin set forth in the *Draft Watershed and Sub-basin Planning Principles* include:

- The Central San Juan Sub-basin south of San Juan Creek is comprised of mainly silty-sandy terrains similar to those found in the Chiquita and Gobernadora Sub-basins. The

eastern and western edges of this sub-basin have sharply different properties, discussed below.

- Clayey silts and sands that underlie smaller areas east of the Mission Viejo fault have a high propensity for shallow mudflows following periods of extended rainfall.
- The area along Radio Tower Road contains representative wetland types including riverine, alkali marsh, slope wetlands, vernal pools and lacustrine fringe wetlands. The slope wetlands appear to be associated with localized bedrock landslides from the San Onofre and Monterey formations that store groundwater discharge over a prolonged period. The vernal pools are also associated with landslides and support both the federally listed endangered San Diego and the Riversidean fairy shrimp. Manmade stock ponds support fringing lacustrine wetlands. Riverine reaches within this area are generally high-gradient, low-order streams characterized as steep canyons dominated by sycamore or willow riparian forest. Some areas appear to have perennial or near-perennial flow.
- Sand, hard rock and minerals have been mined for Trampas Canyon over the last 50 years. A artificial lake dominates this sub-basin. The lake is steep-sided, relatively deep and does not appear to support any aquatic resources of note. The surrounding uplands are dominated by ruderal vegetation with minimal habitat value.
- Runoff and base flow from Trampas Creek may contribute to supporting a small arroyo toad population near its confluence with San Juan Creek.

The selection and sizing of the facilities in the combined control systems for the Central San Juan and Trampas Sub-basin was guided by site conditions, the type of development land use, and incorporation of the planning recommendations. Table 4-14 lists the planning recommendations for the Central San Juan and Trampas Sub-basin set forth in the *Draft Watershed and Sub-basin Planning Principles* and how the recommendations affected the choice and configuration of the combined control systems.

**Table 4-14: Incorporation of the *Planning Recommendations* into BMP Selection**

Planning Recommendations	Site Planning and Treatment/Flow Control BMPs
<ul style="list-style-type: none"> <li>• Trampas Canyon is suitable for development.</li> </ul>	<ul style="list-style-type: none"> <li>• Planning Area 5 is located in the Trampas Canyon drainage area.</li> </ul>
<ul style="list-style-type: none"> <li>• The area along Radio Tower Road should be protected because it contains a diversity of wetland types and endangered fairy shrimp in close proximity to one another, thereby increasing the heterogeneity of the landscape from an aquatic resources perspective.</li> </ul>	<ul style="list-style-type: none"> <li>• No development is planned along Radio Tower Road.</li> </ul>



Planning Recommendations	Site Planning and Treatment/Flow Control BMPs
<ul style="list-style-type: none"> <li>Stormwater flows from Trampas Creek into San Juan Creek should be managed to provide flows comparable to existing conditions.</li> </ul>	<ul style="list-style-type: none"> <li>The combined control system for the Trampas drainage area is designed to emulate existing hydrologic conditions.</li> </ul>

**4.4.3 Combined Control System: Elements and Sizes by Planning Area – Alternative B-4**

The following describes the proposed combined facilities for each of the proposed planning areas in the Central San Juan and Trampas Sub-basin for Alternative B-4.

***Planning Area 3***

The Central San Juan Sub-basin includes a portion of Planning Area 3 (PA 3) north of the San Juan River. The proposed development within PA 3 is described as “general development” and includes a segment of proposed roadway. Runoff generated from these areas is discharged directly to segments of San Juan Creek that have been identified as arroyo toad habitat. To protect breeding habitat for arroyo toads within the San Juan Creek, flow duration controls will be incorporated and managed in a manner compatible to that for other sub-basins/catchments with flow duration control systems. The portions of Planning Area 3 within the Central San Juan Sub-basin can be hydraulically divided into three separate subcatchments. Runoff from each subcatchment will be treated by a combined control facility that includes a FD/WQ basin, and infiltration basin, and a vegetated swale that will connect to the tributary channel.

***Planning Area 4***

Planning Area 4 (PA 4) is located in the eastern portion of the Central San Juan Sub-basin, southeast of San Juan Creek. The planning area includes 216 acres of estates with some additional roadways. As with PA 3 flow duration controls are required to protect breeding habitat for the arroyo toad. Runoff from PA 4 will be treated by a single combined control facility that includes a FD/WQ basin, and infiltration basin, and a vegetated swale that will connect to the tributary channel.

***Planning Area 5***

The southern portion of the Central San Juan and Trampas Sub-basin is the proposed location for Planning Area 5 (PA 5). PA 5 contains an existing sand mining and washing operation which is indicative of the highly infiltrative soils in the area. As with PA 3, PA 5 is primarily defined as “general development” and includes a segment of proposed roadway. PA 5 discharges to two separate tributaries of San Juan Creek: Trampas Creek and an unnamed creek west of Trampas. These tributaries provide habitat that is sensitive to hydrologic changes. Therefore, flows from PA 5 will be managed for flow duration control.

PA 5 has been divided into four separate catchments. Runoff from each catchment will be treated by a combined control facility that includes a FD/WQ basin, and infiltration basin, and a vegetated swale that will connect to the tributary channel (Unnamed Creek or Trampas Creek).

Currently, most of the area occupied by the sand mine and washing facilities does not contribute surface flows to Trampas Creek or any other tributary of San Juan Creek. All surface water runoff is discharged to a tailings pond onsite and is recycled for mining operations. The construction of PA 5 will replace the sand mine and discharges from the developed area will be routed to a water quality/flow duration facility designated as CSJ-4. However, because the artificial lake does not discharge to Trampas Creek, the FD/WQ basin incorporated into CSJ-4 was sized to match flows into Trampas Creek before the mine was constructed, with the objective to restore flows in Trampas Creek to the pre-mine hydrologic regime.

### ***Facilities and Sizing***

Table 4-15 presents the proposed combined control facilities for the Central San Juan and Trampas Sub-basin. Due to the sensitive nature of the receiving waters in the Central San Juan Sub-basin to changes in flow duration, all flows generated from the proposed development will be treated in combined control systems consisting of a flow control/water quality basin, a separate infiltration basin, and a lined or unlined bioswale (CSJ-1, CSJ-2, CSJ-3, CSJ-4, CSJ-5, CSJ-6, CSJ-7, CSJ-8).

Table 4-16 shows the estimated sizes of the various facilities. In general, more volume control is required where the development will be located on sandy infiltrative soils, and where the development is more urbanized. This is evident in CSJ-4 where the majority of the runoff from developed conditions must be infiltrated into the subsurface in order to match the natural flow regime in Trampas Creek. Less volume control will be necessary for less dense development, i.e., having lower percent imperviousness and located on less permeable soils. This is the case for CSJ-8 that was designed to treat runoff from estate areas. A significant portion of PA 3 will be located on rock out-crop. Because these rocky areas produce significant runoff during existing conditions, the increase in runoff volume due to development is less significant. Consequently, less volume control is required to match the flows in San Juan Creek.

**Table 4-15: Combined Control System Requirements for the Central San Juan and Trampas Sub-basins- Alternative B-4**

Facility ID	Tributary Catchments	FD/WQ Basin	ED Basin	Infiltration Basin	Vegetated Swale		Inter Sub-basin Transfer	Storage and Recycling	Comments
					Unlined	Lined			
CSJ-1	13, 14, 17, 18a, 19, PA5-2	✓		✓		✓			Standard combined control system. Water is conveyed from flow duration basin to the infiltration basin through vegetated swales, allowing further water quality treatment. Bypassed flows are directed to xx Creek.
CSJ-2	18b, 23, PA5-1	✓		✓		✓			Same as CSJ-1
CSJ-3	22, PA5-3	✓		✓		✓			Standard combined control system. Water is conveyed from flow duration basin to the infiltration basin through vegetated swales, allowing further water quality treatment. Bypassed flows are directed to Trampas Creek.
CSJ-4	25a, 25b, PA5-4	✓		✓		✓			Same as CSJ-3
CSJ-5	33, 36 <sup>1</sup> , 37, PA3-4, PA3-5	✓		✓		✓			Standard combined control system. Water is conveyed from flow duration basin to the infiltration basin through vegetated swales, allowing further water quality treatment. Bypassed flows are directed to San Juan Creek.
CSJ-6	26, 28, 29, PA3-3, PA3-6	✓		✓		✓			Same as CSJ-5
CSJ-7	16, 20, 21, 27, PA3-1, PA3-2, PA3-7, PA3-8	✓		✓		✓			Same as CSJ-5
CSJ-8	32, 34, 36 <sup>1</sup> , 38	✓		✓		✓			Same as CSJ-5

<sup>1</sup>A small portion of Catchment 36 (designated as ‘general developed’) is included with PA 3. The remaining areas of the catchment are included in PA 4.

**Table 4-16: Combined Control System Facilities and Sizes in Central San Juan and Trampas Sub-basin- Alternative B-4**

Facility ID	Tributary Catchment	Facility Tributary Area <sup>1</sup> (acre)	F.D./W.Q. Basin			Infiltration Basin <sup>3</sup>	
			% Capture <sup>2</sup>	Area (acres)	Volume (ac-ft)	Area (acres)	Volume (ac-ft)
CSJ-1	13, 14, 17, 18a, 19, PA5-2	316	76	5.7	21.8	2.7	5.5
CSJ-2	18b, 23, PA5-1	109	96	3.5	20.4	1.1	2.1
CSJ-3	22, PA5-3	215	98	7.2	40.5	2.7	5.4
CSJ-4	25a, 25b, PA5-4	555	98	11.2	83.5	8.9	18.0
CSJ-5	33, 36 <sup>4</sup> , 37, PA3-4, PA3-5	474	58	3.7	29.4	3.4	6.6
CSJ-6	26, 28, 29, PA3-3, PA3-6	335	81	3.75	16.5	5.0	9.7
CSJ-7	16, 20, 21, 27, PA3-1, PA3-2, PA3-7, PA3-8	560	74	8.1	56.5	2.6	5.0
CSJ-8	32, 34, 36 <sup>4</sup> , 38	229	25	2.1	8.6	0.3	0.5

<sup>1</sup>Tributary area includes project development within the catchment; open space and existing development are not included.

<sup>2</sup>Percent of average annual runoff volume predicted by the model that is captured in the basin.

<sup>3</sup>Infiltration basin sizes assume no infiltration occurs in vegetated swales. Infiltration areas and volumes may be divided between infiltration basin and swales in detailed design, with consideration of maintaining flow durations.

<sup>4</sup>A small portion of Catchment 36 (designated as 'general developed') is included with PA 3. The remaining areas of the catchment are included in PA 4 and are thus treated by a separate water quality basin.

#### **4.4.4 Combined Control System: Elements and Sizes by Planning Area – Alternative B-9**

The following describes the proposed combined facilities for each of the proposed planning areas in the Central San Juan and Trampas Sub-basin for Alternative B-9.

##### ***Planning Area 3***

There are no significant differences between the B-4 Alternative and the B-9 Alternative for Planning Area 5 (PA 5). Because of this, the treatment facility descriptions and sizing presented in Section 4.4.3 of this report are valid for the B-9 Alternative and thus will not be reproduced in this section.

### ***Planning Area 4***

Planning Area 4 (PA 4) is located in the eastern portion of the Central San Juan Sub-basin, southeast of San Juan Creek. The planning area extends into the neighboring Verdugo Sub-basin. The proposed development within PA 3 is described as “general development” and includes multiple segments of proposed roadway. Runoff generated from these areas is discharged directly to segments of San Juan Creek that have been identified as arroyo toad habitat. As with the B-4 Alternative, flow duration control will be implemented to protect the breeding habitat for arroyo toads within San Juan Creek. Planning Area 4 within the Central San Juan Sub-basin was divided into two subcatchments. Runoff from each subcatchment will be treated by separate combined control facilities that includes a FD/WQ basin, an infiltration basin, and a vegetated swale that will connect to the tributary channel.

### ***Planning Area 5***

As with PA 3, there are no significant differences between the B-4 Alternative and the B-9 Alternative for Planning Area 5 (PA 5). The treatment facility descriptions and sizing presented in Section 4.4.3 of this report are valid for the B-9 Alternative and thus will not be reproduced in this section.

### ***Facilities and Sizing***

Table 4-17 presents the proposed combined control facilities for PA 4 in the Central San Juan and Trampas Sub-basin. Basin sizes for the PA 3 and PA 5 (namely CSJ-1, CSJ-2, CSJ-3, CSJ-4, CSJ-5, CSJ-6, and CSJ-7) do not differ between the B-4 and B-9 Alternatives and are not reproduced in this section (see Tables 4-15 and 4-16).

Due to the sensitive nature of the receiving waters in the Central San Juan Sub-basin to changes in flow duration, all flows generated from the proposed development will be treated in combined control systems consisting of a flow control/water quality basin, a separate infiltration basin, and a lined or unlined bioswale. The basins presented here are identified as CSJ-9 and CSJ-10.

Table 4-18 shows the estimated sizes of the various facilities. A large portion of PA 4 will be located on rock out-crop. By developing directly on these rocky areas, the increase in runoff volume is minimized, thus less volume control is required.

**Table 4-17: Combined Control System Requirements for PA 4 in the Central San Juan and Trampas Sub-basins- Alternative B-9**

Facility ID	Tributary Catchments	FD/ WQ Basin	ED Basin	Infiltration Basin	Vegetated Swale		Inter Sub-basin Transfer	Storage and Recycling	Comments
					Unlined	Lined			
CSJ-9	31, 32a,32b 33, PA4-1, PA4-2	✓		✓		✓			Standard combined control system. Water is conveyed from flow duration basin to the infiltration basin through vegetated swales, allowing further water quality treatment. Bypassed flows are directed to San Juan Creek
CSJ-10	35, 38, PA4-3	✓		✓		✓			Same as CSJ-8, Alternative B-9

**Table 4-18: Control System Facilities and Sizes for PA 4 in Central San Juan and Trampas Sub-basin- Alternative B-9**

Facility ID	Tributary Catchment	Facility Tributary Area <sup>1</sup> (acre)	F.D./W.Q. Basin			Infiltration Basin <sup>3</sup>	
			% Capture <sup>2</sup>	Area (acres)	Volume (ac-ft)	Area (acres)	Volume (ac-ft)
CSJ-9	31, 32a,32b 33,PA4-1, PA4-2	429	62	8.3	33.7	3.64	7.2
CSJ-10	35, 38, PA4-3	310	36	3.2	11.7	0.27	0.5

<sup>1</sup>Tributary area includes project development within the catchment; open space and existing development are not included.

<sup>2</sup>Percent of average annual runoff volume predicted by the model that is captured in the basin.

<sup>3</sup>Infiltration basin sizes assume no infiltration occurs in vegetated swales. Infiltration areas and volumes may be divided between infiltration basin and swales in detailed design, with consideration of maintaining flow durations.

#### **4.5 WATER QUALITY MANAGEMENT PLAN FOR THE CRISTIANITOS SUB-BASIN**

##### **4.5.1 Site Assessment**

The Cristianitos Canyon drainage basin, upstream of the confluence with Gabino Creek, is located in the San Mateo Creek watershed approximately five miles from the Pacific Coast (Figure 4-7). The sub-basin area encompasses 3.7 square miles. The sub-watershed is aligned north-to-south and ranges in elevation from 280 ft (MSL) at the confluence of Cristianitos and Gabino Creeks to 1000 ft (MSL) at the head of Cristianitos Canyon.

The Cristianitos Sub-basin is underlain by bedrock of the Santiago and Silverado formations. Surficial geologic units within the project boundaries consist of alluvium, colluvium, nonmarine terrace deposits, and a few landslides (PCR et al, 2002). The majority of the Cristianitos Sub-basin is underlain by poorly infiltrating soils of hydrologic groups C (43.9 percent) and D (42.7 percent). However, compared to other sub-basins of the San Mateo watershed included in the WQMP, the upper Cristianitos Canyon also contains a relatively large portion of the better infiltrating soil group B (12.9 percent). The relatively high proportion of Type B soils and the minimal development in the sub-basin produce relatively high infiltration rates relative to the other sub-basins within the San Mateo watershed.

Soils west of Cristianitos Creek are characterized by erodible silty sands, while soils east of the creek generally are clays (NCCP/SAMP Workgroup, 2003b). However, the lower portion of Cristianitos Creek appears to be actively incising (PCR et al, 2002). Review of aerial photographs shows that prior to the extreme flow event of 1938, the reach of Cristianitos Creek upstream from the confluence of Gabino Creek was little more than a swale and seems to have incised 8 to 15 feet since that time. This portion of the creek is likely susceptible to further incision, and associated in-channel sediment generation, during extreme flow events.

As illustrated in Figure 4-8, the sub-basin is dominated by grasslands, a significant component of which is native grassland, and coastal sage scrub (NCCP/SAMP Workgroup, 2003b). The extent of grasslands in the sub-basin strongly suggests that nitrogen loading is currently high, while the high erosion potential indicates that the mobilization of phosphorus sources may be equally high. Metal loadings to the sub-basin are likely low at present and most metal transport can be expected in the particulate form.

Aquatic resources in the Cristianitos Sub-basin consist of both riverine and lacustrine (associated with abandoned clay pit mines and stockponds) systems (PCR et al, 2002). The upper portions of the sub-basin consist of a ridge or spine with canyons on both sides. These canyons are steep and narrow and contain well-developed, mature oak riparian woodland in a matrix of intact chaparral and coastal sage scrub. The structure, location in the headwaters, and juxtaposition with intact upland plant communities results in high functioning upland/wetland ecosystems. Cristianitos Creek, below an existing stockpond, is a meandering stream that contains alkali marsh communities mixed with willow and mule fat. However this reach is actively incising. Reaches just upstream of Gabino Creek have near-perennial flow, apparently supported by discrete loci of groundwater discharge. The persistent saturation has facilitated development of well-structured hydric soils, and as the gradient flattens, there is a moderate width floodplain associated with the stream. This area supports the highest diversity of wetland species of any of the San Mateo sub-basins studied.

There are several lacustrine wetlands in the sub-basin associated with abandoned clay pits or stockponds (PCR et al, 2002). In general, these areas appear to be functioning as intact wetlands. They contain a mix of open water and emergent marsh vegetation. Most are surrounded by a mix of sage scrub and grasslands. One of the stockponds on the lower end of Cristianitos Creek has a stream dominated by mule fat scrub draining into it. The ponds generally appear to have low turbidity and are being used by fish, invertebrates, amphibians, and birds. A large, abandoned clay pit exists near the southern boundary of the sub-basin. This pit is approximately 80 to 100 feet deep and dominated by open water with a narrow fringe of emergent marsh habitat. This large, abandoned pit is blue-green in color, and it does not appear to be functioning as a viable ecosystem.

### ***Existing Land Uses***

The Cristianitos Sub-basin is largely undeveloped, aside from roadways. There are several abandoned clay pits on the east side of the lower portion of the sub-basin. The Donna O'Neill Land Conservancy is located outside of the RMV boundary on the west side of the middle and lower portions of the sub-basin.

### ***Future Land Uses***

The development alternatives in the Cristianitos Sub-basin address approximately 1,275 acres within the RMV boundary in Planning Areas 6 and 7 (Figure 4-8 and Table 4-19). Under the B-4 Alternative, approximately 802 acres would remain as open space and 724 acres would be



developed, including a 195 acre golf course. The Alternative B-4 grading plan for this sub-basin would redirect runoff from approximately 194 acres into the lower Gabino Sub-basin and 30 acres into the Central San Juan and Trampas Sub-basin within PA 5 and PA 6, while runoff from approximately 1 acre of the lower Gabino Sub-basin and 4 acres of the Central San Juan and Trampas Sub-basin would be redirected into the Cristianitos Sub-basin. Overall, the Cristianitos Sub-basin would lose approximately 219 acres. No development would occur in the Cristianitos Sub-basin under the B-9 alternative.

**Table 4-19: Land Uses and Areas in the Cristianitos Sub-basin**

Alternative	Land Uses	Land Use Area within the Cristianitos Sub-basin (acres) <sup>1</sup>
B-4	Estate	2
	Golf Course	195
	Proposed Development	527
	Reserve Open Space	551
	TOTAL	<b>1,275</b>
B-9	Proposed Development	1
	Non-reserve Open Space	0
	Reserve Open Space	1,274
	TOTAL	<b>1,275</b>

<sup>1</sup>Land use area within the pre-development sub-basin boundary.

#### **4.5.2 Planning Considerations and Planning Recommendations for the Cristianitos Sub-basin**

Specific hydrologic planning considerations for the Cristianitos Sub-basin set forth in the *Draft Watershed and Sub-basin Planning Principles* include:

- Cristianitos Sub-basin has a less “flashy” hydrograph than other sub-basins of the western San Mateo Watershed due to its shape, infiltration characteristics, and drainage network.
- The terrains to the west of Cristianitos Creek are generally erodible silty sands while the terrains to the east of the Creek are generally less erodible clays (where not disturbed). Intact clayey terrains tend to seal and functionally become nearly impervious upon saturation, generating more rapid runoff than sandy terrains.
- Major riparian areas exist in the northeast and southwest portions of the sub-basin.
- The middle and lower areas to the east of the creek contain few riparian areas and include numerous former open clay pits that are eroding and are not self healing.
- The middle portion of Cristianitos Creek supports alkaline wetlands. The hydrologic support of these wetlands in relation to the surface and subsurface hydrology of this

portion of Cristianitos Creek is not fully understood; however, recently installed groundwater monitoring wells will help clarify this issue.

- The clay-rich soils to the east of the creek generate fine sediments, generally silts and clays, which contribute to turbidity in downstream waters (as contrasted with coarser sediments such as sands, silty sands, and cobbles contributed by Gabino and La Paz).
- A review of 1938 aerial photos indicates that the mainstem of Cristianitos Creek upstream from the confluence with Gabino Creek appears to have been deepening over the past 60 years.

The selection and sizing of the facilities in the combined control systems for the Cristianitos Sub-basin was guided by site conditions, the type of development land use, and incorporation of the planning recommendations. Table 4-20 lists the planning recommendations for the Cristianitos Sub-basin set forth in the *Draft Watershed and Sub-basin Planning Principles* and how the recommendations affected the choice and configuration of the combined control systems.

**Table 4-20: Incorporation of the *Planning Recommendations* into BMP Selection**

Planning Recommendations	Site Planning and Treatment/Flow Control BMPs
<ul style="list-style-type: none"> <li>• The headwater area should be protected, with new impervious surfaces limited in extent within the headwater area.</li> </ul>	<ul style="list-style-type: none"> <li>• Alternative B-4: no development planned for the headwaters in the East Branch of Cristianitos Creek. Development planned for the West Branch is predominately golf course, a land use with limited impervious surfaces.</li> <li>• Alternative B-9: no development in the Cristianitos sub-basin.</li> </ul>
<ul style="list-style-type: none"> <li>• Where feasible, protected headwater areas should be targeted for restoration of native vegetation to reduce the generation of fine sediments from the clayey terrains and to promote infiltration, and to enhance the value of upland habitats adjacent to the streams.</li> </ul>	<ul style="list-style-type: none"> <li>• Restoration is proposed in the headwater areas. Refer to the Habitat Restoration Plan contained in Appendix J of the AMP.</li> </ul>
<ul style="list-style-type: none"> <li>• In order to mimic existing hydrologic conditions, development should focus on areas with clayey soils, which presently seal fairly quickly under storm conditions and have relatively high runoff rates. The overall goal should be to reduce the generation of fine sediments compared with existing conditions to reduce turbidity effects and other adverse impacts of fine sediments on downstream aquatic resources. Development in the middle and lower reach areas should be set back from the creek and should be located to the east of the creek where existing erosion could be concurrently addressed.</li> </ul>	<ul style="list-style-type: none"> <li>• A major portion of proposed Alternative B-4 development will be located east of the creek in the middle and lower portions of the sub-basin in areas with clay soils and is set back from the creek.</li> </ul>

Planning Recommendations	Site Planning and Treatment/Flow Control BMPs
<ul style="list-style-type: none"> <li>Stream stabilization opportunities should be examined in Cristianitos Creek (above the confluence with Gabino Creek) in the context of longer-term geologic processes.</li> </ul>	<ul style="list-style-type: none"> <li>Refer to the Habitat Restoration Plan contained in Appendix J of the AMP.</li> </ul>
<ul style="list-style-type: none"> <li>The alkali wetlands within the middle portion of the sub-basin should be protected in conjunction with protection of the overall riparian system.</li> </ul>	<ul style="list-style-type: none"> <li>The proposed Alternative B-4 development is set back from the creek.</li> </ul>

### **4.5.3 Combined Control System: Elements and Sizes by Planning Area**

The following describes the proposed combined facilities for each of the proposed planning areas within the Cristianitos Sub-basin for Alternative B-4. No development is planned in the Cristianitos Sub-basin in the B-9 alternative.

#### ***Planning Area 6***

Planning Area 6 (PA6) includes 195 acres of proposed golf course and 52 acres of general development adjacent to the golf course. Runoff from the development area adjacent to the golf course will be captured and stored as non-potable water for golf course irrigation. The potential benefits of this concept include a reduction of runoff volumes typically associated with urban development and a reduction of water importation to meet irrigation demands. The storage facilities would additionally function as a wet pond for treatment of the stormwater, prior to use for irrigation. The main limitation is that runoff and peak irrigation demands are seasonally out of phase (runoff occurs in the wet season and peak irrigation demands are in the dry season).

#### ***Planning Area 7***

Approximately 475 acres of Planning Area 7 (PA7) extends beyond the boundaries of the Gabino Sub-basin and into the Cristianitos Sub-basin. The planning area is designated as general development, but does include a section of proposed roadway throughout the eastern section of the sub-basin. The soils underlying the proposed development are primarily clay and clay loam, which limit the feasibility of infiltration, unless grading is used to create loam conditions in potential infiltration areas.

The gentle slope of the headwaters combined with the higher infiltration rates of the area in the western portion of the sub-basin comprising the Donna O’Neill Land Conservancy results in less “flashy” hydrographs and lower peak flows in Cristianitos Creek than observed in other sub-basins in San Mateo. The lower reaches of the creek support a high diversity of wetland species that are attracted to the saturated conditions caused by near-perennial flows. However, the creek has been incising since 1938 and is potentially susceptible to further incising. Due to the sensitivity of the stream to changes in flow regime, runoff flows into Cristianitos Creek will be managed with FD/WQ basins.

Furthermore, the lack of infiltrative soils in the eastern portion of the sub-basin will necessitate the diversion of excess flows generated from PA7 out of the Cristianitos Sub-basin to lower Gabino Creek near the confluence with lower Cristianitos Creek. This is considered acceptable because lower Gabino Creek, like San Juan Creek, is a relatively large braided stream with coarse substrate that can accommodate increases in runoff without causing excessive erosion or inducing significant habitat changes. By comparison, increased runoff into Cristianitos Creek above existing conditions is considered likely to cause excessive erosion and possibly modify the existing alkaline wetland habitat.

PA7 is separated into four drainage areas, each draining to a combined control facility consisting of a FD/WQ basin, a low-flow diversion to Gabino Creek, and a series of lined vegetated swales for conveyance to Cristianitos Creek.

### ***Facilities and Sizing***

Table 4-21 presents the proposed combined control system facilities for the Cristianitos Sub-basin.

**Table 4-21: Combined Control System Requirements for the Cristianitos Sub-basin- Alternative B-4**

Facility ID	Tributary Catchments	FD/WQ Basin	ED Basin	Infiltration Basin	Vegetated Swale		Direct Discharge to Gabino Creek	Non-domestic Water Supply Storage and Recycling	Comments
					Unlined	Lined			
Cristianitos-1	PA7-9	✓				✓	✓		Flow duration control required for discharge into Cristianitos Creek. Excess flows are treated and discharged directly to Gabino Creek.
Cristianitos-2	PA7-10	✓				✓	✓		Flow duration control required for discharge into Cristianitos Creek. Excess flows are treated and discharged directly to Gabino Creek.
Cristianitos-3	54, PA7-11	✓				✓	✓		Flow duration control required for discharge into Cristianitos Creek. Excess flows are treated and discharged directly to Gabino Creek.
Cristianitos-4	55, 58, PA7-14, PA7-16	✓				✓	✓		Flow duration control required for discharge into Cristianitos Creek. Excess flows are treated and discharged directly to Gabino Creek.
Cristianitos-5	PA6-1, PA6-2, PA6-3, PA6-4		✓					✓	Excess surface flows will be collected and stored on the golf course to be reused as irrigation. The on-site storage facility provides water quality treatment.

Table 4-22 presents the estimated sizes of the various facilities. The storage and recycling facility located in PA6 (designated as Cristianitos-5) requires 12 acre-feet of storage, which is significantly larger than the required treatment volume (WEF, 1998). The remaining facilities (Cristianitos-1 through 4) are combined FD/WQ basins. The predicted basin volumes are comparable in size with the exception of Cristianitos-4, which is slightly larger. Peak flows significantly increase from areas tributary to Cristianitos-4, thus requiring a larger storage volume.

**Table 4-22: Combined Control System Facilities and Sizes in the Cristianitos Sub-basin-Alternative B-4**

Facility ID	Catchment Numbers	Facility Tributary Area <sup>1</sup> (acre)	F.D./W.Q. Basin			Infiltration Basin <sup>3</sup>	
			% Capture <sup>2</sup>	Area (acres)	Volume (ac-ft)	Area (acres)	Volume (ac-ft)
Cristianitos-1	PA7-9	56	91	1.3	6.6	-	-
Cristianitos-2	PA7-10	71	87	1.4	8.6	-	-
Cristianitos-3	54, PA7-11	78	96	1.6	7.1	-	-
Cristianitos-4	55, 58, PA7-14, PA7-16	72	85	1.6	12.2	-	-
Cristianitos-5	PA6-1, PA6-2, PA6-3, PA6-4	228	>90	3	12	-	-

<sup>1</sup>Tributary area includes project development within the catchment; open space and existing development are not included.

<sup>2</sup>Percent of average annual runoff volume predicted by the model that is captured in the basin.

<sup>3</sup>Infiltration basin sizes assume no infiltration occurs in vegetated swales. Infiltration areas and volumes may be divided between infiltration basin and swales in detailed design, with consideration of maintaining flow durations.

## **4.6 WATER QUALITY MANAGEMENT PLAN FOR THE GABINO PORTION OF THE GABINO AND BLIND CANYON SUB-BASIN**

### **4.6.1 Site Assessment**

Because runoff management and water quality strategies for the B-4 and B-9 alternatives link Blind Canyon and the Talega Sub-basin functionally, this section addresses only areas that drain to Gabino Creek. Gabino Canyon encompasses 8.3 square miles and is approximately 10 miles long (PCR et al, 2002). Along with Talega Canyon, it is the largest sub-basin in the upper San Mateo watershed. The Gabino Canyon Sub-basin is divided into three main planning subunits: the upper Gabino Canyon subunit, the middle Gabino subunit, and the lower Gabino subunit (NCCP/SAMP Working Group, 2003b). (The lower Gabino subunit includes Blind Canyon, which will be addressed in the Section 4.7 with the Talega Sub-basin). The upper Gabino subunit encompasses the open grasslands at the headwaters of Gabino Creek. A portion of

Planning Area 9 is located in the upper Gabino subunit (Figure 4-9). The middle Gabino subunit is defined by the narrow, steep-sided canyon between upper Gabino Canyon and the confluence of Gabino and La Paz creeks. A portion of Planning Area 7 is located within the middle Gabino subunit. The lower Gabino subunit includes the portion of Gabino Canyon below its confluence with La Paz Creek and its confluence with Cristianitos Creek. This subunit includes a portion of Planning Area 7 and a portion of Planning Area 8.

Gabino Canyon is underlain primarily by bedrock of the Williams Formation (Pleasant sandstone and Schulz Ranch members), along with the Santiago, Silverado, Ladd (Baker Canyon member), and Trabuco formations (PCR et al, 2002). Surficial geologic units within the project boundaries consist of alluvium, colluvium, nonmarine terrace deposits, and a few landslides.

The Gabino Sub-basin is underlain by clayey and crystalline terrains that generally produce higher runoff volumes per unit area than sandier areas (PCR et al, 2002). However, compared to other crystalline terrains in the NCCP/SAMP study area, Gabino Canyon has the highest infiltration capacity of any of the analyzed sub-basins in the San Mateo watershed. Approximately 56 percent of the upper sub-basin is underlain by Type C soils, with 31 percent of the upper basin having the least permeable Type D soils. Infiltration capacity is somewhat lower in the lower portion of the sub-basin, with D-type soils being predominant.

Gabino Canyon was calculated to have the highest sediment yield and transport rate of any sub-basin analyzed in the San Mateo watershed (PCR et al, 2002). These high yields are partially attributable to the size of the sub-basin; however, the transport rate per unit area is also high, second only to the Cristianitos Sub-basin. Cobbles and other larger particles comprise the majority of sediment produced in this sub-basin; however, unlike La Paz, sand comprises a substantial portion of the sediment produced. The relatively high proportion of underlying sandy substrates (compared to the rest of the crystalline areas in the study area) likely contributes to the high sediment yield predicted for Gabino Canyon. Incision of the channel in the reaches just upstream of the confluence with La Paz also is a likely source of sediment. However, a significant portion of the sediment production is probably associated with erosion caused by historic grazing. Conversion of native habitat to non-native grassland, along with continued grazing, appears to have resulted in extensive gully formation adjacent to Gabino Creek and resultant increases in sediment delivery to downstream areas. A critical feature of the sediment transport characteristics of Gabino Canyon is that most of the sediment is mobilized during extreme episodic events, when the topography, unstable upland soils, and substrate types contribute to produce large quantities of sediment. The coarse sediment is probably very important to downstream channel structure and provides habitat for sensitive species in the middle and lower watershed.

The high proportion of grasslands in the upper watershed represents a potential source of high nitrogen loadings (PCR et al, 2002). Similarly phosphate loadings are expected to be moderate, mainly associated with erosion in the upper watershed. Incision in the upper reaches of Gabino Canyon and the naturally confined floodplain in the lower reaches mean that assimilation of

nitrate and phosphate loadings are expected to be low to moderate within the riparian floodplain. Baseline metal loadings should be relatively low under existing conditions with most metals transported in particulate form.

The Gabino ground-water basin extends from near the confluence of La Paz and Gabino Creeks downstream to the canyon constriction just downstream of the Gabino/Cristianitos confluence, a valley distance of about 10,000 feet. The upper portion of the basin is cut into bedrock, but alluvial deposits get progressively deeper further downstream. Based on estimates of basin size and specific yield, the potential water-holding volume of the basin between the two confluences is about 400 acre-ft. It is fair to assume that the basin can assimilate about 0.2-0.3 cfs of summer flow, assuming that groundwater levels are sufficiently deep to inhibit establishment of riparian woodland.

The dominant habitat type in the upper portion of Gabino Canyon, above the confluence with La Paz Creek, is southern coast live oak riparian woodland (PCR et al, 2002). The adjacent uplands are primarily disturbed grasslands with sage scrub on the hillslopes. The upper watershed has been heavily grazed and is incised in places with vegetation that has been cropped or trampled. The riparian zone varies in width from relatively narrow to relatively wide and is well developed (depending on the intensity of grazing). Historically, the stream probably migrated through the floodplain, but now is confined by headcutting and incision processes. In some reaches this incision is in excess of ten feet and appears to have intercepted subsurface flow.

A manmade lake/stockpond in upper Gabino canyon, informally known as "Jerome's Pond," captures water from Gabino Creek and three unnamed tributaries (PCR et al, 2002). The pond can be characterized as a semi-marsh mix of open water and bulrush (*S. californicus*). Where Gabino creek flows into the stockpond, there is a delta dominated by mule fat scrub. The pond outlets into a tributary that supports willow riparian habitat and eventually joins the main flows of Gabino Creek. Above the pond, the tributaries are a mix of oak riparian and broad floodplain sycamore habitats. Portions of these tributaries exhibit slumping and erosion, probably resulting from grazing impacts, perhaps in conjunction with fires. A major unnamed tributary flows into Gabino Creek just upstream of its confluence with La Paz Creek. The natural drainage pattern of this tributary has been substantially altered over time by mining activities, including the creation of a series of artificial ponds.

Lower Gabino Creek (below the confluence with La Paz), middle Gabino Creek, and La Paz Creek support structurally diverse, mature oak and southern sycamore riparian woodland with dense chaparral on the adjacent slopes (PCR et al, 2002). The center of the stream has a rock cobble substrate overlain by areas of shallow alluvial deposits that support mule fat scrub. The floodplain and riparian zones in the lower sub-basin are confined by the geology of the valley, but contain high topographic complexity (including bars and ponds that were inundated during our site visit), an abundance of coarse and fine woody debris, leaf litter, and a mosaic of plant communities. In many years, the creek flows through the late spring and seasonal pools persist in some locations, but seldom through the summer.



### ***Existing Land Uses***

The Gabino Sub-basin is largely undeveloped and is used for grazing. There is a manmade lake/stockpond in upper Gabino canyon and several abandoned clay pits on the west side of the lower portion of the sub-basin.

### ***Future Land Uses***

The development alternatives in the Gabino Sub-basin address approximately 4,360 acres within the RMV boundary in Planning Areas 7 and 9 and only a very small portion of PA8.(Figure 4-10 and Table 4-23). Under the B-4 Alternative, approximately 3,661 acres would remain as open space (including a proposed stream buffer in the PA 9 golf course) and 699 acres would be developed, including 263 acres of golf course within PA 9 and PA 8, 20 acres of casitas in PA 9, 161 acres of estates in PA 7 and PA 9, 5 acres of residential land use associated with the golf course in PA 8, and 250 acres of general development in PA 7. The Alternative B-4 grading plan for this sub-basin would redirect runoff from approximately 1 acre into the Cristianitos Sub-basin and 37 acres into the Blind Sub-basin, while runoff from approximately 194 acres of the Cristianitos Sub-basin and 18 acres of the Blind Sub-basin would be redirected into the Gabino Sub-basin. Overall, the Gabino Sub-basin would gain approximately 174 acres of drainage area.

Under the B-9 alternative, approximately 4,280 acres would be designated as reserve open space. No development would occur in Planning Areas 7 and 9 in lower, middle and upper Gabino under Alternative B-9.

**Table 4-23: Land Uses and Areas in the Gabino Sub-basin**

<b>Alternative</b>	<b>Land Uses</b>	<b>Land Use Area within the Gabino Sub-basin (acres)<sup>1</sup></b>
<b>B-4</b>	Casitas	20
	Estate	197
	Golf Course	263
	Golf Residential	5
	Golf Resort	0
	Proposed Development	269
	Open Space	3,606
	<b>TOTAL</b>	<b>4,360</b>
<b>B-9</b>	Golf Course	0
	Golf Resort	0
	Proposed Development	16
	Open Space	4,344
	<b>TOTAL</b>	<b>4,360</b>

<sup>1</sup>Land use area within the pre-development sub-basin boundary.

#### **4.6.2 Planning Considerations and Planning Recommendations for the Gabino Sub-basin**

Specific hydrologic planning considerations for the Gabino Sub-basin set forth in the *Draft Watershed and Sub-basin Planning Principles* include:

- Gabino and Talega Canyons are the largest sub-basins in the western San Mateo watershed.
- Gabino Canyon has the highest predicted absolute peak flow and runoff volume of the sub-basins studied in the western San Mateo watershed. This is due to its size, position high in the watershed, steep topography, and the narrow geologically confined nature of the middle and lower reaches of the sub-basin. Simulated hydrographs indicate a somewhat “flashy” runoff response in this sub-basin.
- Gabino Canyon has the highest predicted sediment yield and transport rate of any sub-basin analyzed in the western Sam Mateo sub-watersheds.
- Fine sediment generation in the upper sub-basin may exceed natural conditions due to extensive gully formation in the headwater areas.
- Terrains in the middle reaches are very steep, with high drainage densities and have very limited stormwater infiltration capacity.
- Sediments produced from the middle portion of the sub-basin are primarily coarse sediments, including sands and cobbles, which are mobilized and transported during extreme episodic events. These sediments are probably very important to downstream channel structure and provide geomorphologic elements of habitats for sensitive species found in the middle and lower reaches of Gabino Creek and further downstream.
- In wet years, the creek flows through the late spring and seasonal pools persist in some locations (probably associated with bedrock outcrops). However, these pools seldom if ever persist through the summer.
- Groundwater does not appear to be a significant element of the Creek’s hydrologic system, with the possible exception of the lower reaches (i.e., below the confluence with La Paz). It appears that the alluvium in this sub-basin is recharged during winter runoff events and once the limited aquifer storage has been seasonally depleted, little ongoing replenishment occurs until the next event.
- Along the lower reaches of the Creek, terrains to the north include clayey soils and a major unnamed side canyon that has been extensively modified by clay mining activities.
- The area south of Blind Canyon is comprised of a mesa top that has been grazed and is characterized by high gradient, coarse-bedded channel, and sycamore and oak riparian

forest. The slopes of the canyon contain other significant habitat, including coast live oak.

The selection and sizing of the facilities in the combined control systems for the Gabino Sub-basin was guided by site conditions, the type of development land use, and incorporation of the planning recommendations. Table 4-24 lists the planning recommendations for the Gabino Sub-basin set forth in the *Draft Watershed and Sub-basin Planning Principles* and how the recommendations affected the choice and configuration of the combined control systems.

**Table 4-24: Incorporation of the *Planning Recommendations* into BMP Selection**

Planning Recommendations	Site Planning and Treatment/Flow Control BMPs
<ul style="list-style-type: none"> <li>Limit new impervious surfaces in the headwater area to locations that will not adversely impact runoff patterns.</li> </ul>	<ul style="list-style-type: none"> <li>Land uses proposed for Upper Gabino in Alternative B-4– estates, golf course, and golf resort - have limited impervious surfaces.</li> <li>No development is proposed in upper Gabino in Alternative B-9.</li> </ul>
<ul style="list-style-type: none"> <li>Protect the headwaters through restoration of existing gullies using a combination of slope stabilization, grazing management, and native grasslands and/or scrub restoration. To the extent feasible, restore native grasses to reduce sediment generation and promote infiltration of stormwater.</li> </ul>	<ul style="list-style-type: none"> <li>Restoration is proposed in upper Gabino (Figure 4-10). Refer to the Habitat Restoration Plan contained in Technical Appendix J-2 of the Ranch Plan EIR.</li> <li>Under Alternative B-4, soils stabilization would occur in conjunction with development.</li> </ul>
<ul style="list-style-type: none"> <li>Modify grazing management in the upper portion of the sub-basin to support restoration and vegetation management in the headwater areas.</li> </ul>	<ul style="list-style-type: none"> <li>Refer to the Habitat Restoration Plan contained in Technical Appendix J-2 of the Ranch Plan EIR.</li> </ul>
<ul style="list-style-type: none"> <li>Minimize impacts to the steep side canyons in the middle portion of the sub-basin by limiting new impervious surfaces.</li> </ul>	<ul style="list-style-type: none"> <li>No development is proposed for the steep side canyons in the middle sub-basin area.</li> </ul>
<ul style="list-style-type: none"> <li>To the extent feasible, focus development in the clayey soils and terrains in the lower portions of the sub-basin, where it could serve to reduce the generation of fine sediments and associated turbidity.</li> </ul>	<ul style="list-style-type: none"> <li>Alternative B-4 proposes general development and estates in the west side of the lower portion of the sub-basin on clayey soils.</li> </ul>
<ul style="list-style-type: none"> <li>To the extent feasible, utilize the side canyon currently degraded by past mining activities for natural water quality treatment systems.</li> </ul>	<ul style="list-style-type: none"> <li>A clay mine pit would be used as a water quality treatment facility.</li> </ul>
<ul style="list-style-type: none"> <li>In the lower reach of the Creek, protect significant riparian habitats along the south side of the Creek and on proximate side canyon slopes.</li> </ul>	<ul style="list-style-type: none"> <li>Riparian habitats along the south side of the Creek in the lower sub-basin and proximate side canyon slopes have been protected.</li> </ul>

Planning Recommendations	Site Planning and Treatment/Flow Control BMPs
<ul style="list-style-type: none"> <li>Protect the integrity of arroyo toad populations in lower Gabino Creek by maintaining hydrologic and sediment delivery processes, including maintaining the flow characteristics of episodic events in the sub-basin. Utilize natural water quality treatment systems to manage and treat runoff from any new land uses in areas adjacent to the lower creek.</li> </ul>	<ul style="list-style-type: none"> <li>Although flows are being diverted into the lower Gabino Sub-basin from the Cristianitos Sub-basin in order to protect Cristianitos Creek and to utilize the ability of lower Cristianitos Creek to accept increased flows, the discharge point for the diverted flows from Cristianitos and the combined control system facilities in the lower Gabino Sub-basin is located as close as possible to the confluence with lower Cristianitos Creek in order to protect arroyo toad populations in lower Gabino Creek.</li> <li>The combined control system integrates natural treatment processes for water quality treatment.</li> </ul>

#### **4.6.3 Combined Control System: Elements and Sizes by Planning Area – Alternative B-4**

The following describes the proposed combined facilities for each of the proposed planning areas within the Gabino Sub-basin for the B-4 alternative. The small area of proposed general development in PA 8 in the B-9 alternative would drain to the area within the Blind Canyon Sub-basin, which is discussed in Section 4.7

##### ***Planning Area 7***

Planning Area 7 (PA7) is comprised of 250 acres of general development and 126 acres of estates. It straddles the Cristianitos and Gabino Sub-basins and, due to the grading plan, will divert a significant portion of the runoff from the Cristianitos Sub-basin to Gabino Creek. This is considered acceptable because lower Gabino Creek, like San Juan Creek, is a relative large braided stream with coarse substrate that can accommodate increases in runoff without causing excessive erosion or inducing significant habitat changes. By comparison, increased runoff into Cristianitos Creek is considered likely to cause excessive erosion and possibly modify the existing alkaline wetland habitat. Additionally, the ability to route excess surface flows at the lower end of lower Gabino Creek allows the utilization of the functional capacity of lower Cristianitos Creek to accept increased flows.

The treatment strategy for PA7 includes the use of an existing abandoned clay mine pit as a “wet” extended detention basin for treatment (designated as Gabino-1). A “wet” extended detention basin incorporates two pools: a permanent pool of water and a temporary water quality pool that is drawn down over 48 hours following a storm event. There is no pond outlet at this time, but an outlet structure would be provided to achieve the desired drain time. The pit is also hydraulically connected through the groundwater table to Gabino Creek so water that infiltrates into the pond will migrate as a subsurface flow into Gabino Creek. Enroute additional treatment will be achieved through filtration.

All flows generated in PA7 within the Gabino Sub-basin will be collected and conveyed to the Gabino-1 water quality basin located at the down gradient end of Catchment PA7-1. The water quality basin was designed according to the WEF method (WEF, 1998).

### ***Planning Area 8***

The grading plan of Planning Area 8 (PA8) diverts a small portion of the proposed golf course (approximately 50 acres) to Gabino Creek. As with PA6 within the Cristianitos Sub-basin (Section 4.5.3), the treatment strategy for this portion of PA8 is to capture and store runoff as a source of non-potable water for golf course irrigation. The storage facilities would additionally function as a wetpond for treatment of the stormwater, prior to irrigation use. The methodology used to size the storage facility is discussed in Section 4.5.3 above.

### ***Facilities and Sizing***

Table 4-25 presents the proposed treatment facilities for the middle and lower Gabino Sub-basin. Due to the lack of infiltrative soils, runoff from PA7 will be treated in water quality basins without infiltration and will be then be discharged to Gabino Creek. Golf course runoff from PA8 will be stored in water features and recycled as irrigation.

Table 4-26 presents the sizes for the proposed BMPs in Gabino Canyon. As previously stated, Gabino-1 was sized according to the WEF method, a method that typically provides a capture efficiency between 82 and 88% of the total runoff volume (WEF, 1998). However, the majority of PA7 is situated on clayey soils, thus producing a larger runoff volume and reducing the capture efficiency of the water quality basin. The storage reservoir required for Gabino-2 significantly exceeds the water quality volume required by the WEF method.

**Table 4-25: Combined Control System Requirements for Gabino- Alternative B-4**

Facility ID	Catchment Numbers	F.D. Basin	W.Q Basin	Infiltration Basin	Vegetated Swale		Inter Sub-basin Transfer	Storage and Recycling	Comments
					Unlined	Lined			
Gabino-1	68, 72, 73, 74, 76, 77, PA7-1, PA7-2, PA7-3, PA7-4, PA7-5, PA7-6, PA7-7, PA7-12, PA7-13, PA7-15		✓			✓			Water quality treatment only. It is assumed that no flow control is required because flows are directly discharged to Gabino Creek. Water quality treatment will be achieved using an existing quarry pond that will be modified to provide additional storage.
Gabino-2	PA8-12, PA8-14		✓					✓	Golf course area: Runoff will be collected and stored on-site to be used as irrigation. The on-site storage facility provides water quality treatment.

**Table 4-26: Combined Control System Facilities and Sizes in the Gabino Sub-basin- Alternative B-4**

Facility ID	Catchment Numbers	Facility Tributary Area <sup>1</sup> (acre)	F.D./W.Q. Basin			Infiltration Basin <sup>3</sup>	
			% Capture <sup>2</sup>	Area (acres)	Volume (ac-ft)	Area (acres)	Volume (ac-ft)
Gabino-1	68, 72, 73, 74, 76, 77, PA7-1, PA7-2, PA7-3, PA7-4, PA7-5, PA7-6, PA7-7, PA7-12, PA7-13, PA7-15	560	78	2	21	-	-
Gabino-2	PA8-12, PA8-14	50	>90	3	12	-	-

<sup>1</sup>Tributary area includes project development within the catchment; open space and existing development are not included.

<sup>2</sup>Percent of average annual runoff volume predicted by the model that is captured in the basin.

<sup>3</sup>Infiltration basin sizes assume no infiltration occurs in vegetated swales. Infiltration areas and volumes may be divided between infiltration basin and swales in detailed design, with consideration of maintaining flow durations.

In the upper portion of the Gabino Sub-basin within Planning Area 9, the B-4 alternative would include very low density estate homes, casitas, and a golf course. The very low density housing would be incorporated within the large area of surrounding open space.

Given that the estate homes will be widely dispersed, controls for the estates are most feasible if conducted onsite or in common areas and will consist of site design, source control, and treatment practices, such as vegetated swales and planter boxes.

The combined control system for the golf course and casitas within Planning Area 9 would be similar to the system for the golf course located within Planning Area 6 described in Section 4.5.3 and will be sized using the method described.

#### **4.7 WATER QUALITY MANAGEMENT PLAN FOR THE BLIND CANYON PORTION OF THE GABINO AND BLIND SUB-BASIN AND THE TALEGA SUB-BASIN**

##### **4.7.1 Site Assessment**

Blind Canyon is a tributary watershed to Gabino that joins Gabino Creek just upstream of the confluence of Gabino Creek with lower Cristianitos Creek (Figure 4-11). Blind Canyon is a high gradient, coarse substrate stream, dominated by sycamore and oak riparian gallery forest with a mule fat-dominated understory (PCR et al, 2002). The stream contains good topographic complexity, leaf litter, and coarse and fine woody debris. There are numerous high gradient, low order tributaries to Blind Canyon. Some contain scrub oak-dominated riparian forest, others are unvegetated swales. Several of the tributaries appear to pond seasonally at naturally occurring

grade changes, but do not exhibit any features of slope wetlands. D-type soils are predominant in Blind Canyon.

Talega Canyon encompasses 8.3 square miles and straddles the boundary of Rancho Mission Viejo and Camp Pendleton (Figure 4-11). The Talega Canyon Sub-basin is extremely elongated, with the longest watercourse over 10.1 miles. Approximately one-third to one-half of the Talega Canyon drainage basin lies within the RMV boundary, most of which is occupied by the existing Northrup-Grummond facilities.

The Talega Sub-basin is underlain by bedrock of the Santiago, Silverado, Williams, and Trabuco formations and the Santiago Peak Volcanics (PCR et al, 2002). Within the boundaries of RMV, the underlying bedrock consists of the Santiago and Silverado formations and the Pleasants sandstone and Schulz Ranch members of the Williams formations. Surficial geologic units within the alternatives boundaries consist of alluvium, colluvium, nonmarine terrace deposits and a few landslides.

The majority of the sub-watershed is underlain by soils of hydrologic groups C (18.8 percent) and D (75.6 percent) (PCR et al, 2002). Talega Canyon has the highest proportion of poorer infiltrating Type D soils of any of the other sub-basins analyzed in the San Mateo watershed. The lack of available data and the fact that a significant portion of the basin is outside the study area (in Camp Pendleton) prevented analysis of sediment yield or transport rates for this sub-basin.

Nitrogen loading from the Talega Sub-basin should be relatively low given the existing land use and cover (PCR et al, 2002). However, the potential for generating large amounts of fine sediments indicates that Talega can be a significant source of phosphates. Historical aerial photography shows that a well-vegetated floodplain has often been absent, suggesting that the riparian corridor may play a relatively minor role in cycling of pollutants. However, some sequestration may occur in pockets where sandy substrates are found. Metal partitioning should heavily favor transport in the less biologically available particulate forms.

The riparian zones of Talega Creek are similar to those found in lower Cristianitos and Lower Gabino Creeks (PCR et al, 2002). Substrate is rock/cobble dominated with sandbars forming in depositional areas. The riparian habitat consists of dense stands of structurally diverse, mature coast live oak and southern sycamore riparian woodlands. Center portions of the creek support mule fat scrub and open sand bar habitat. The riparian zones are confined by the geology of the valley, but contain high topographic complexity, an abundance of coarse and fine woody debris, leaf litter, and a mosaic of understory plant communities. The creek contains shallow pools that retain water into the late spring and early summer. Some of the highest concentrations of southwestern arroyo toad in the San Mateo watershed are located along Talega Creek.



**Existing Land Uses**

The Blind and Talega Sub-basins are largely undeveloped aside from the Northrop-Grumman (formerly know as TRW) facility. Areas in Blind Canyon are used for grazing.

**Future Land Uses**

The development alternatives in the Blind and Talega Sub-basins address approximately 1,974 acres within the RMV boundary in Planning Area 8 (Figure 4-12 and Table 4-27). Under the B-4 Alternative, approximately 1,092 acres would remain as open space and 882 acres would be developed, including 136 acres of golf course, 86 acres of residential and resort area associated with the golf course, and 661 acres of general development. The Alternative B-4 grading plan would redirect runoff from approximately 18 acres of the Blind Sub-basin into the Gabino Sub-basin and 3.4 acres into the lower Cristianitos Sub-basin, while runoff from approximately 37 acres of the Gabino Sub-basin and 478 acres of the Talega Sub-basin would be redirected into the Blind Sub-basin. Overall, the Blind Sub-basin would gain approximately 494 acres of drainage area. The Alternative B-4 grading plan would also redirect runoff from approximately 40 acres of the lower Cristianitos Sub-basin into the Talega Sub-basin, for an overall loss of approximately 437 acres in the Talega Sub-basin.

Under the B-9 alternative, approximately 1,080 acres would remain as open space, while 894 acres would be developed into golf course, golf resort, and general development. No grading plans are available at this time specific to Alternative B-9, it is assumed that the drainage strategy for this alternative would be similar to the drainage plan proposed for the B-4 alternative.

**Table 4-27: Land Uses and Areas in the Blind and Talega Sub-basins**

<b>Alternative</b>	<b>Land Uses</b>	<b>Land Use Area within the Blind and Talega Sub-basins (acres)<sup>1</sup></b>
<b>B-4</b>	Golf Course	136
	Golf Residential	66
	Golf Resort	20
	Proposed Development	661
	Open Space	1091
	<b>TOTAL</b>	<b>1,974</b>
<b>B-9</b>	Golf Course	225
	Golf Resort	25
	Proposed Development	644
	Reserve Open Space	1080
	<b>TOTAL</b>	<b>1,974</b>

<sup>1</sup>Land use area within the pre-development sub-basin boundary.

#### **4.7.2 Planning Considerations and Planning Recommendations for the Blind Canyon Drainage Area and Talega Sub-basins**

Specific planning considerations for the Blind Sub-basin set forth in the *Draft Watershed and Sub-basin Planning Principles* include:

- The slopes of Blind Canyon contain significant habitat including coast live oak.

Specific hydrologic planning considerations for the Talega Sub-basin set forth in the *Draft Watershed and Sub-basin Planning Principles* include:

- Talega Canyon straddles the boundary of RMV and Camp Pendleton, with at least a third of the upper watershed located outside of the SAMP/MSAA and NCCP study areas in the San Mateo Wilderness Area. The existing TRW facilities are on the ridge above Talega Canyon, with runoff draining both to Talega Canyon and to Blind Canyon.
- Talega Canyon has the highest proportion of poorer infiltrating Type D soils of any of the other sub-basins analyzed in the San Mateo watershed and yield relatively high runoff volumes. Although the simulated hydrographs for Talega Creek have a pronounced peak, they are relatively broad. The broader peaking is likely due to the elongated geometry of the sub-basin, which tends to attenuate flood movement as it travels through the sub-basin. Thus, runoff volumes are high but peak discharge rates are attenuated as stormwater travels downstream through the sub-basin.
- The headwaters of Talega Creek (which are outside of the SAMP/MSAA and NCCP study areas) are in weathered granitic rocks that sustain a substantial density of springs. These springs help support a denser riparian corridor in the upper portion of the sub-basin, and may contribute to late season moisture in Talega Creek.
- Talega Creek supports one of the two largest populations of arroyo toads in the planning area. The creek substrate is rock/cobble with sandbars forming in depositional areas. Riparian habitat consists of dense stands of mature, structurally diverse coast live oak and southern sycamore riparian woodlands. Central reaches of the creek support mule fat scrub and open sand bar habitat. Riparian zones contain high topographic complexity, and abundance of coarse and woody debris, leaf litter and a mosaic of understory plant communities. The creek contains shallow pools that retain water into the late spring and early summer, a water supply likely to be of significance for arroyo toad breeding habitat, but does not appear to be sufficient to sustain steelhead.

The selection and sizing of the facilities in the combined control systems for the Blind Canyon drainage area and the Talega Sub-basin was guided by site conditions, the type of development land use, and incorporation of the planning recommendations. Table 4-28 lists the planning recommendations for the Blind and Talega Sub-basins set forth in the *Draft Watershed and Sub-*

*basin Planning Principles* and how the recommendations affected the choice and configuration of the combined control systems.

**Table 4-28: Incorporation of the *Planning Recommendations* into BMP Selection**

Planning Recommendations	Site Planning and Treatment/Flow Control BMPs
<ul style="list-style-type: none"> <li>Limit development and other uses in Blind Canyon to the grazed areas on the mesa and away from the major oak woodlands in Blind Canyon. Direct to and treat stormwater runoff in areas that will not contribute to appreciable increases in water delivery/flow to the oak woodlands in the lower portion of the sub-basin.</li> </ul>	<ul style="list-style-type: none"> <li>Under the B-4 alternative, proposed development areas in Blind Canyon are away from the major oak woodlands.</li> <li>Under Alternative B-9, significant development would occur in Blind Canyon.</li> <li>Runoff from Blind Canyon will be treated before being discharged to infiltration basins located near the confluence of Gabino Creek and Blind Creek.</li> </ul>
<ul style="list-style-type: none"> <li>To the extent feasible, major stormwater flows from development areas in the Talega sub-basin should emulate current runoff patterns. Runoff during the dry season and high frequency/low magnitude storms (generally 1–2 year storm events) should be routed through natural water quality treatment systems and, where feasible, encouraged to flow generally away from arroyo toad habitat in Talega Canyon and toward Blind Canyon.</li> </ul>	<ul style="list-style-type: none"> <li>The proposed grading plan directs excess flows from areas once tributary to Talega Creek to Blind Creek. Excess flows are treated and diverted into infiltration basins located in Blind Canyon. Flow duration control is used to preserve the existing flows in Talega Creek.</li> </ul>
<ul style="list-style-type: none"> <li>Development should focus on the Talega Canyon ridge tops to avoid the canyon bottoms and preserve the steeper slopes. To the extent practical, development should generally be in the area of the existing TRW facilities and adjacent ridges to the east/northeast.</li> </ul>	<ul style="list-style-type: none"> <li>The proposed development in both Alternative B-4 and Alternative B-9 is limited to the area of the Northrop-Grumman (formerly known as TRW) site and adjacent ridges to the east/northeast.</li> </ul>
<ul style="list-style-type: none"> <li>The timing of peak flows in Talega Creek should emulate the timing of flows under existing conditions.</li> </ul>	<ul style="list-style-type: none"> <li>The combined control system will preserve the timing of existing flows in Talega Creek.</li> </ul>

**4.7.3 Combined Control System: Elements and Sizes by Planning Area – Alternative B-4**

The following describes the proposed combined facilities for Planning Area 8 within the Blind and Talega Sub-basins for Alternative B-4.

***Planning Area 8***

Planning Area 8 (PA8) can be divided into two separate drainage areas divided by Blind Creek. The proposed development north of Blind Creek includes 170 acres of golf course with approximately 71 acres of low density residential development (“golf residential”). Areas of PA8 south of Blind Creek include 508 acres of general development and 130 acres of estates.

The underlying soils are predominantly clay with moderate patches of sandy loam that limit the ability to infiltrate runoff.

The grading plan for PA8 will significantly alter the tributary areas to Blind Creek and Talega Creek. In order to protect arroyo toad breeding habitat in Talega Creek, approximately 478 acres of area currently tributary to Talega Creek will be graded in a manner that will divert excess flows towards Blind Canyon. The existing tributary area of Blind Creek is the smallest of any drainage area in the study area. Increases in surface water runoff resulting from increases in impervious area on Blind Canyon mesa and in drainage due to shifting 478 acres in the Talega Creek Sub-basin could significantly alter the flow regime of the Blind Canyon stream. To prevent this, runoff from the general development and estates will be treated and infiltrated. The control strategy for these areas includes the use of two extended detention water quality treatment basins, one treating runoff from the estates (Blind-3) and the other treating runoff from the 478 acres of general development in the Talega Sub-basin (Blind-1). Treated and bypassed flows from each of the water quality basins will be directed to separate lined vegetated swale that will discharge to two separate infiltration basins located in patches of sandy loam in the lower elevations of Blind Canyon.

Runoff from the golf course will be captured and stored onsite as a source of non-potable water for golf course irrigation. The storage facilities would additionally function as a wetpond for treatment of the stormwater, prior to use irrigation. The methodology used to size the storage facility is discussed in Section 4.5.3 above.

Talega Creek is of particular concern in that it hosts a “major population” of arroyo toads and supports some of the highest quality riparian habitat in the NCCP/SAMP study area. To maintain existing flows to Talega Creek, flows generated from portions of PA8 (specifically Catchment PA8-6) will be used to match the existing runoff conditions. This will incorporate the use of a single FD/WQ basin designated as Blind-2, with a vegetated swale that will connect to the main stem of Talega Creek.

### ***Facilities and Sizing***

Table 4-29 presents the proposed treatment facilities for the Blind and Talega Sub-basins for Alternative B-4. The small patches of sandy loam located at the base of Blind Canyon will be used to infiltrate treated runoff from the general development and estate areas. A portion of the general development will be used to maintain flows in Talega Creek using a combined flow duration/water quality facility. As in the Gabino and Cristianitos Sub-basins, golf course runoff from PA8 will be stored in water features or non-domestic water supply reservoirs and recycled for irrigation.

Table 4-30 presents the sizes for the proposed BMPs in the Blind and Talega Sub-basins. The water quality basins (Blind-1 and Blind-3) were sized according to the WEF method and are predicted to capture 88 percent of the runoff volume. The flow duration/water quality facility located in PA8-6 (Blind-2) was sized to divert 48 percent of the runoff to Talega Creek to

maintain existing flows. The remaining 62 percent will be routed to an infiltration basin located near where Blind Canyon Creek joins with Gabino Creek. Flows from both basins would be routed through vegetated swales to provide additional water quality treatment. The storage reservoir sized for Blind-4 significantly exceeds the water quality volume required by the WEF method.

**Table 4-29: Combined Control System Requirements for Blind Canyon- Alternative B-4**

Facility ID	Tributary Catchments	FD/WQ Basin	ED Basin	Infiltration Basin	Vegetated Swale		Graded to Divert Runoff from Talega to Blind	Non-domestic Water Supply Storage and Recycling	Comments
					Unlined	Lined			
Blind-1	PA8-3, PA8-4, PA8-5		✓	✓		✓	✓		Water quality treatment only. Flows are treated in detention basins in Blind Canyon before being discharged to infiltration basins located near the confluence of Gabino and Blind Creek.
Blind-2	PA8-6	✓		✓		✓	✓		Due to the proposed grading plan, areas once tributary to Talega Creek now discharge to Blind Creek. Flow duration control is used to preserve the existing flows in Talega Creek. Excess flows are treated and diverted to infiltration basins located in Blind Canyon.
Blind-3	PA8-7, PA8-8, PA8-9		✓	✓		✓	✓		Water quality treatment only. Flows are treated in detention basins in Blind Canyon before being discharged to infiltration basins located near the confluence of Gabino and Blind Creek.
Blind-4	PA8-10, PA8-11, PA8-13		✓					✓	Golf course area: Runoff will be collected and stored on-site to be used as irrigation. The on-site storage facility provides water quality treatment.

**Table 4-30: Combined Control System Facilities and Sizes in Blind Canyon-Alternative B-4**

Facility ID	Tributary Catchments	Facility Tributary Area <sup>1</sup> (acre)	FD/WQ Basin			Infiltration Basin <sup>3</sup>	
			% Capture <sup>2</sup>	Area (acres)	Volume (ac-ft)	Area (acres)	Volume (ac-ft)
Blind-1	PA8-3, PA8-4, PA8-5	375	88	4.1	15.6	4.5	8.8
Blind-2	PA8-6	146	62	1.2	7.9	0.7	1.4
Blind-3	PA8-7, PA8-8, PA8-9	117	88	0.7	2.8	0.8	1.5
Blind-4	PA8-10, PA8-11, PA8-13	239	>90	3.8	15	-	-

<sup>1</sup>Tributary area includes project development within the catchment; open space and existing development are not included.

<sup>2</sup>Percent of average annual runoff volume predicted by the model that is captured in the basin.

<sup>3</sup>Infiltration basin sizes assume no infiltration occurs in vegetated swales. Infiltration areas and volumes may be divided between infiltration basin and swales in detailed design, with consideration of maintaining flow durations.

#### **4.7.4 Combined Control System: Elements and Sizes by Planning Area – Alternative B-9**

The following describes the proposed combined facilities for Planning Area 8 within the Blind and Talega Sub-basins for Alternative B-9.

##### ***Planning Area 8***

Under the B-9 alternative, Planning Area 8 (PA 8) is bisected by Blind Creek. The planning area is primarily located in the Blind Sub-basin with portions of the development extending into the Talega Sub-basin. Although no grading plans were available for PA 8, it is assumed that all developed will be graded in a manner that will discharge into Blind Creek, thus increasing the Blind Sub-basin tributary area. The predominant development characterized as ‘general development’ will be located in the lower portions Blind Canyon near the confluence of Blind Creek and Gabino Creek. The remaining area of PA 8, characterized as golf course and golf resort, will be located in the upper end of the Canyon where the underlying soils are predominantly clay.

The grading plan for PA8 will significantly alter the tributary areas to Blind Creek and Talega Creek. As previously stated Talega Creek is of particular concern in that it hosts a “major population” of arroyo toads and supports some of the highest quality riparian habitat in the NCCP/SAMP study area. However, a portion of the Talega Sub-basin will be graded towards Blind Creek. To maintain existing flows to Talega Creek, flows generated from portions of PA 8 south of Blind Creek (specifically Catchment T-1) will be used to match the existing runoff

conditions. This will incorporate the use of a single FD/WQ basin designated as Blind-5, with a vegetated swale that will connect to the main stem of Talega Creek. Excess flows will be diverted to the Talega Sub-basin and used to mimic the natural behavior of Talega Creek. Treated flows will be conveyed to an infiltration basin located on the sandy patches near Blind Creek.

The existing tributary area of Blind Creek is the smallest of any drainage area in the study area. Increases in surface water runoff resulting from the increase in impervious area and tributary area associated with the grading of the Talega Sub-basin could significantly alter the flow regime of the Blind Creek. To prevent this, runoff from all development within the existing Blind Sub-basin will be treated in a single FD/WQ basin designated as Blind-6. Vegetated swales will convey excess flows to Blind Creek in order to preserve the existing flow regime. Treated flows will be collected and stored onsite as a source of non-potable water for irrigation. The storage facilities would additionally function as a wetpond for treatment of the stormwater, prior to use irrigation. The methodology used to size the storage facility is discussed in Section 4.5.3 above. Treated flows that exceed the 20-acre-ft onsite storage capacity would be conveyed to infiltration basins located on selected patches of sandy soils.

### ***Facilities and Sizing***

Table 4-31 presents the proposed treatment facilities for the Blind and Talega Sub-basins for Alternative B-9. A portion of the general development will be used to maintain flows in Talega Creek using a combined flow duration/water quality facility with excess flows diverted to infiltration basins. Flows in Blind Creek will be maintained using a separate combined flow duration/ water quality facility.

Table 4-32 presents the sizes for the proposed BMPs in the Blind and Talega Sub-basins. The combined facility designated as Blind-6 was designed to maintain flows in Blind Creek. As previously stated, treated flows would be stored onsite. Any treated flows exceeding the storage capacity would be infiltrated. However, the infiltration basins were sized to handle all flows out of the flow duration/ water quality basin. This conservative design provides adequate capacity in the infiltration basins in the event that the onsite storage facilities reach maximum capacity or are taken off-line.



**Table 4-31: Combined Control System Requirements for Blind Canyon- Alternative B-9**

Facility ID	Tributary Catchments	FD/WQ Basin	ED Basin	Infiltration Basin	Vegetated Swale		Graded to Divert Runoff from Talega to Blind	Non-domestic Water Supply Storage and Recycling	Comments
					Unlined	Lined			
Blind-5	T-1	✓		✓		✓	✓		<p>Due to the proposed grading plan, areas once tributary to Talega Creek now discharge to Blind Creek. Flow duration control is used to preserve the existing flows in Talega Creek. Excess flows are treated and diverted to infiltration basins located in Blind Canyon. Flows are discharged to Talega Creek are conveyed in lined vegetated swales.</p>
Blind-6	64, 65, 66, 67, 68, 70, 71	✓		✓		✓		✓	<p>Flow duration control is used to preserve the existing flows in Blind Creek. Excess flows are treated and diverted to onsite storage facilities to be used for irrigation. Any flows exceeding the storage capacity are infiltration in Blind Canyon. Flows are discharged to Blind Creek are conveyed in lined vegetated swales.</p>

**Table 4-32: Combined Control System Facilities and Sizes in Blind Canyon-Alternative B-9**

Facility ID	Tributary Catchments	Facility Tributary Area <sup>1</sup> (acre)	FD/WQ Basin			Infiltration Basin <sup>3</sup>	
			% Capture <sup>2</sup>	Area (acres)	Volume (ac-ft)	Area (acres)	Volume (ac-ft)
Blind-5	T-1	663	86	9.5	62.0	9.8	19.3
Blind-6	64, 65, 66, 67, 68, 70, 71	423	66	2.3	18.5	1.2	2.6

<sup>1</sup>Tributary area includes project development within the catchment; open space and existing development are not included.

<sup>2</sup>Percent of average annual runoff volume predicted by the model that is captured in the basin.

<sup>3</sup>Infiltration basin sizes assume no infiltration occurs in vegetated swales. Infiltration areas and volumes may be divided between infiltration basin and swales in detailed design, with consideration of maintaining flow durations

## **4.8 WATER QUALITY MANAGEMENT PLAN FOR THE VERDUGO SUB-BASIN**

### **4.8.1 Site Assessment**

The 4.8 square mile Verdugo Canyon Sub-basin has roughly an east-west orientation (Figure 4-13). Approximately one-half to two-thirds of the Verdugo Canyon Sub-basin lies within the RMV property boundary.

The sub-basin is underlain by bedrock of the Williams, Ladd, and Trabuco formations and the Santiago Peak Volcanics (PCR et al, 2002). Within the RMV boundary, the underlying bedrock consists of the Schulz Ranch and Starr members of the Williams formation, the Holz Shale and Baker Canyon members of the Ladd Formation, and the Trabuco formation. Surficial geologic units within the RMV boundary consist of alluvium, colluvium, nonmarine terrace, deposits and a few landslides of relatively limited areal extent.

Verdugo Canyon had one of the highest predicted infiltration rates of any of the sub-basins studied in the San Juan watershed (PCR et al, 2002). This results from the undeveloped condition of the sub-basin, the relatively high proportion of Type A (8.3 percent) soils (compared to other sub-basins), and relatively low proportion of Type D soils (28.6 percent) compared to other sub-basins in the watershed.

Verdugo Canyon, along with Lucas and Bell Canyons, constitute the more silty portions of the San Juan Creek watershed, with upper portions of the sub-basins containing crystalline terrains (PCR et al, 2002). These areas are characterized by coarser substrates, shallower soils, and steeper slopes than the Chiquita or Gobernadora Sub-basins. The combination of substrate type and slope results in Verdugo Canyon having the highest sediment transport rate per unit area of any of the sub-basins in San Juan Creek watershed. Sediment yield for Verdugo is second behind Bell Canyon. Like many of the steep silty and crystalline areas of the study area, much of

the sediment in Verdugo is mobilized during episodic events and, when mobilized, has the potential to have substantial effect on sediment delivery and on the geomorphology of the downstream areas.

The large quantities of highly erodible soils in the Verdugo Sub-basin can be expected to provide a source of phosphorus loading to San Juan Creek (PCR et al, 2002). Nitrogen loading from the sub-basin is expected to be low given that only six percent of the watershed is covered with grasslands, there are limited anthropogenic sources, and little channel incision. The terrains and steep slope of Verdugo Canyon likely results in direct nutrient and pollutant pathways to surface waters. The existence of an intact riparian corridor implies that there is potential for sequestration of constituents of concern within floodplain terraces, with increased amounts of organic carbon available to augment nitrogen cycling. Speciation is expected to favor the transport of metals and pesticides (were any to be present) in an adsorbed form.

The biological resources of Verdugo Canyon are also similar to those found in Bell or Lucas Canyon (PCR et al, 2002). The streams are predominantly coarse substrate with southern coast live oak riparian woodland, surrounded by sage scrub and chaparral. These areas are more similar to habitats found in the upper San Mateo watershed than to those found in the Chiquita and Gobernadora Sub-basins. Because groundwater is less prevalent than in Chiquita or Gobernadora, the habitats tolerate moderate moisture more than the willow riparian habitats found in those sub-basins. The narrowness of the canyon results in high biological interaction between the habitats of the floodplain and the adjacent uplands.

### ***Existing Land Uses***

The Verdugo Sub-basin is largely undeveloped.

### ***Future Land Uses***

The development alternatives in the Verdugo Sub-basin addresses approximately 1,847 acres within the RMV boundary in Planning Area 4 and Planning Area 9 (Figure 4-14 and Table 4-33). Under the B-4 Alternative, approximately 1,791 acres would remain as open space and 56 acres would be developed, including 1 acre of golf course adjoining the golf course located within the upper Gabino Sub-basin in Planning Area 9, and 55 acres of estates, also in Planning Area 9.

Under the B-9 alternative, approximately 1,368 acres would remain as open space, while 479 acres in Planning Area 4 are proposed for general development. This proposed development is located in the lower portion of the sub-basin, adjacent to the Central San Juan Sub-basin.

**Table 4-33: Land Uses and Areas in the Verdugo Sub-basin**

Alternative	Land Uses	Land Use Area within the Verdugo Sub-basin (acres) <sup>1</sup>
B-4	Golf Course	1
	Estates	108
	Proposed Development	0
	Non-reserve Open Space	0
	Reserve Open Space	1,738
	TOTAL	<b>1,847</b>
B-9	Golf Course	0
	Golf Resort	0
	Proposed Development	479
	Non-reserve Open Space	0
	Reserve Open Space	1,368
	TOTAL	<b>1,847</b>

<sup>1</sup>Land use area within the pre-development sub-basin boundary.

**4.8.2 Planning Considerations and Planning Recommendations for the Verdugo Sub-basin**

Specific hydrologic planning considerations for the Verdugo Sub-basin set forth in the *Draft Watershed and Sub-basin Planning Principles* include:

- Verdugo Canyon has one of the highest soil infiltration rates of any of the sub-basins studies in the San Juan watershed.
- Substrate types and slope result in Verdugo Canyon having the highest sediment transport rate per unit area of any San Juan Creek watershed sub-basin, with sediment yield second behind Bell Canyon. Much of the sediment in Verdugo is mobilized during episodic events and, when mobilized, has the potential to have substantial effects on sediment delivery and on the geomorphology of downstream areas.
- The large quantities of highly erodible soils in the Verdugo Sub-basin are expected to provide a source of phosphorus loading to San Juan Creek.
- The upper portion of the Verdugo Sub-basin is underlain by the Trabuco and Ladd formations, which lack shallow groundwater and yield little base flow. Due to the relative absence of groundwater and the presence of the steep slopes, both upland and riparian habitats reflect drier conditions than in other sub-basins.

- The stream course has a predominantly coarse substrate and is strongly influenced by the narrowness of the canyon.

The selection and sizing of the facilities in the combined control systems for the Verdugo Sub-basin was guided by site conditions, the type of development land use, and incorporation of the planning recommendations. Table 4-34 lists the planning recommendations for the Verdugo Sub-basin set forth in the *Draft Watershed and Sub-basin Planning Principles* and how the recommendations affected the choice and configuration of the combined control systems.

**Table 4-34: Incorporation of the *Planning Recommendations* into BMP Selection**

Planning Recommendations	Site Planning and Treatment/Flow Control BMPs
<ul style="list-style-type: none"> <li>• Development with impervious surfaces should be limited in extent in order to protect the generation and transport of sediment to downstream areas, and to protect Verdugo Canyon from excessive erosion.</li> </ul>	<ul style="list-style-type: none"> <li>• 97% of the sub-basin is preserved as open space in the B-4 alternative. The land use that is proposed in the remaining 3% of the sub-basin is low density estate housing.</li> <li>• 74% of the sub-basin is preserved as open space in the B-9 alternative.</li> </ul>
<ul style="list-style-type: none"> <li>• Development should be set back from significant riparian habitat within the relatively narrow and geologically confined floodplain.</li> </ul>	<ul style="list-style-type: none"> <li>• The proposed development in both alternatives is set back from significant riparian habitat.</li> </ul>
<ul style="list-style-type: none"> <li>• Infiltration functions should be protected through site design. Cumulative stormwater flows should be managed in such a way as to not change peak flows that under present conditions lag behind those of the main stem of San Juan Creek. The area adjacent to the mouth of Verdugo Canyon provides opportunities for infiltration and flow attenuation.</li> </ul>	<ul style="list-style-type: none"> <li>• The combined control system will preserve the timing of existing flows in Verdugo Canyon Creek.</li> </ul>

#### **4.8.3 Combined Control System: Elements and Sizes by Planning Area**

The following describes the proposed combined facilities for the proposed planning area in the Verdugo Sub-basin for Alternative B-9.

##### ***Planning Area 4***

Planning Area 4 (PA 4) extends beyond the eastern boundaries of the Central San Juan Sub-basin and into the Verdugo Sub-basin. The proposed development within PA 4 is described as “general development” and includes multiple segments of proposed roadway. Runoff generated from PA 4 is discharged directly to Verdugo Creek, immediately upstream of the confluence with San Juan Creek. As previously stated, San Juan Creek has been identified as providing breeding habitat for the arroyo toad. To protect the arroyo toad habitat in San Juan Creek, flow duration controls will be incorporated. Runoff generated from all new development within the Verdugo Sub-basin will be treated by a single combined control facility that includes a FD/WQ

basin, an onsite storage facility, an infiltration basin, and a vegetated swale that will connect to the tributary channel. Excess flows would be conveyed to Verdugo Creek through vegetated swales. Treated flows would be collected and stored onsite as a source of non-potable water supply. The storage facilities could be in the form of a wet pond or a structural tank. The methodology used to size the storage facility is discussed in Section 4.5.3 above. Treated flows that exceed the 14-acre-ft onsite storage capacity would be conveyed to an infiltration basin.

### ***Facilities and Sizing***

Table 4-35 presents the proposed combined control system for the Verdugo Sub-basin. To protect the arroyo toad population in San Juan Creek, flows generated from the proposed development will be treated in a combined control system consisting of a flow control/water quality basin, onsite storage facility, infiltration basin, and a lined bioswale.

Table 4-36 shows the estimated sizes of the components of the combined controlled system. The proposed development will be located on highly infiltrative soils (primarily sandy loam). Because of this, the majority of the runoff from developed conditions must be stored or infiltrated into the subsurface in order to match the natural flow regime in Verdugo Creek. The infiltration basins were sized to handle all flows out of the flow duration/ water quality basin, providing adequate capacity in the event that the onsite storage facilities reach maximum capacity or are taken off-line.

**Table 4-35: Combined Control System Requirements for the Verdugo Sub-basin- Alternative B-9**

Facility ID	Tributary Catchments	FD/WQ Basin	ED Basin	Infiltration Basin	Vegetated Swale		Inter Sub-basin Transfer	Storage and Recycling	Comments
					Unlined	Lined			
Verdugo-1	120, 121a, 121b, 121c, 122, PA4-4, PA4-5	✓		✓		✓			Standard combined control system. Water is conveyed from flow duration basin to the infiltration basin through vegetated swales, allowing further water quality treatment. Bypassed flows are directed to Verdugo Creek.

**Table 4-36: Combined Control System Facilities and Sizes the Verdugo Sub-basin- Alternative B-9**

Facility ID	Tributary Catchment	Facility Tributary Area <sup>1</sup> (acre)	F.D./W.Q. Basin			Infiltration Basin <sup>3</sup>	
			% Capture <sup>2</sup>	Area (acres)	Volume (ac-ft)	Area (acres)	Volume (ac-ft)
Verdugo-1	120, 121a, 121b, 121c, 122, PA4-4, PA4-5	481	98	14.8	124.6	3.3	6.5

<sup>1</sup>Tributary area includes project development within the catchment; open space and existing development are not included.

<sup>2</sup>Percent of average annual runoff volume predicted by the model that is captured in the basin.

<sup>3</sup>Infiltration basin sizes assume no infiltration occurs in vegetated swales. Infiltration areas and volumes may be divided between infiltration basin and swales in detailed design, with consideration of maintaining flow durations.

#### **4.9 WATER QUALITY MANAGEMENT PLAN FOR THE NARROW & LOWER SAN JUAN SUB-BASIN AND THE LOWER CRISTIANITOS SUB-BASIN**

This section presents the WQMP elements for those sub-basins that would be impacted by the proposed development alternatives, but were not included in the sections above. Hydrologic and water quality modeling was conducted for most of the Planning Areas and the results of this modeling will be presented in Chapter 5, Impact Analysis. This modeling encompassed the range of terrains and proposed development types in the proposed alternatives, and therefore it was not necessary to model all of the planning areas. These remaining sub-basins were not modeled and therefore sub-basin specific combined control systems were not selected and sized. Using the management concepts employed in other sub-basins with comparable features and characteristics, the sub-basin specific WQMP elements in narrative form for these other sub-basins are presented.

##### **4.9.1 Narrow and Lower San Juan Sub-basin**

Planning Area 1 (PA1) encompasses approximately 540 acres in the western portion of the Narrow Canyon and Lower San Juan Creek Sub-basin (Figure 4-15), east of the City of San Juan Capistrano in the vicinity of Antonia Parkway and Ortega Highway. Runoff from PA 1 would discharge via tributary streams into San Juan Creek. San Juan Creek in this sub-basin is similar to the Central San Juan Creek Sub-basin, with intermittent to near perennial flow in a highly braided channel. Existing land uses within this sub-basin are also similar to the Central San Juan and Trampas Sub-basin, and include general agriculture, nurseries, and orchards on the north and south sides of San Juan Creek in close proximity to the creek, as well as some commercial land use and roadway.

The proposed land uses within PA1 include 465 acres of general development and 75 acres of estates in the B-4 alternative, and 540 acres of general development in the B-9 alternative.



Given that the Narrow Canyon and Lower San Juan Sub-basin is located on clayey terrain, and that hydrologic and geomorphic conditions in the receiving stream, San Juan Creek, are driven by large scale watershed processes, the focus of the WQMP elements for this sub-basin is on water quality treatment, rather than flow duration control. The combined control system facilities will therefore include extended detention water quality basins sized according to the WEF Method specified in the MS4 Permit, with the provision of a 48 hour draw down time.

A small portion of Planning Area 5 (PA5) is also located within the Narrow and Lower San Juan Sub-basin. In both Alternative B-4 and Alternative B-9, approximately 59 acres of general development in the southeast portion of the sub-basin adjoins the PA5 area located within the Central San Juan and Trampas Sub-basin. This area is currently undeveloped grassland or native vegetation. The Alternative B-4 grading plans call for this area and approximately 8 acres of open space to be graded into the Catchment PA5-2 in the Central San Juan and Trampas Sub-basin. This area would drain to combined control facility CSJ-1, which is a standard combined control system that includes a FD/WQ basin and an infiltration basin, with treated flows conveyed in a vegetated swale to the unnamed tributary to San Juan Creek.

#### **4.9.2 Lower Cristianitos Sub-basin**

The Lower Cristianitos Sub-basin is a small area encompassing approximately 290 acres located in the San Mateo Creek watershed south of the Cristianitos Sub-basin, southeast of the Donna O'Neill Conservancy at Rancho Mission Viejo, and west of the lower Gabino, Blind Canyon, and Talega Sub-basins (Figure 4-15). The dominant landscape feature in the area is lower Cristianitos Creek south of the confluence with Gabino Creek where it exits RMV property.

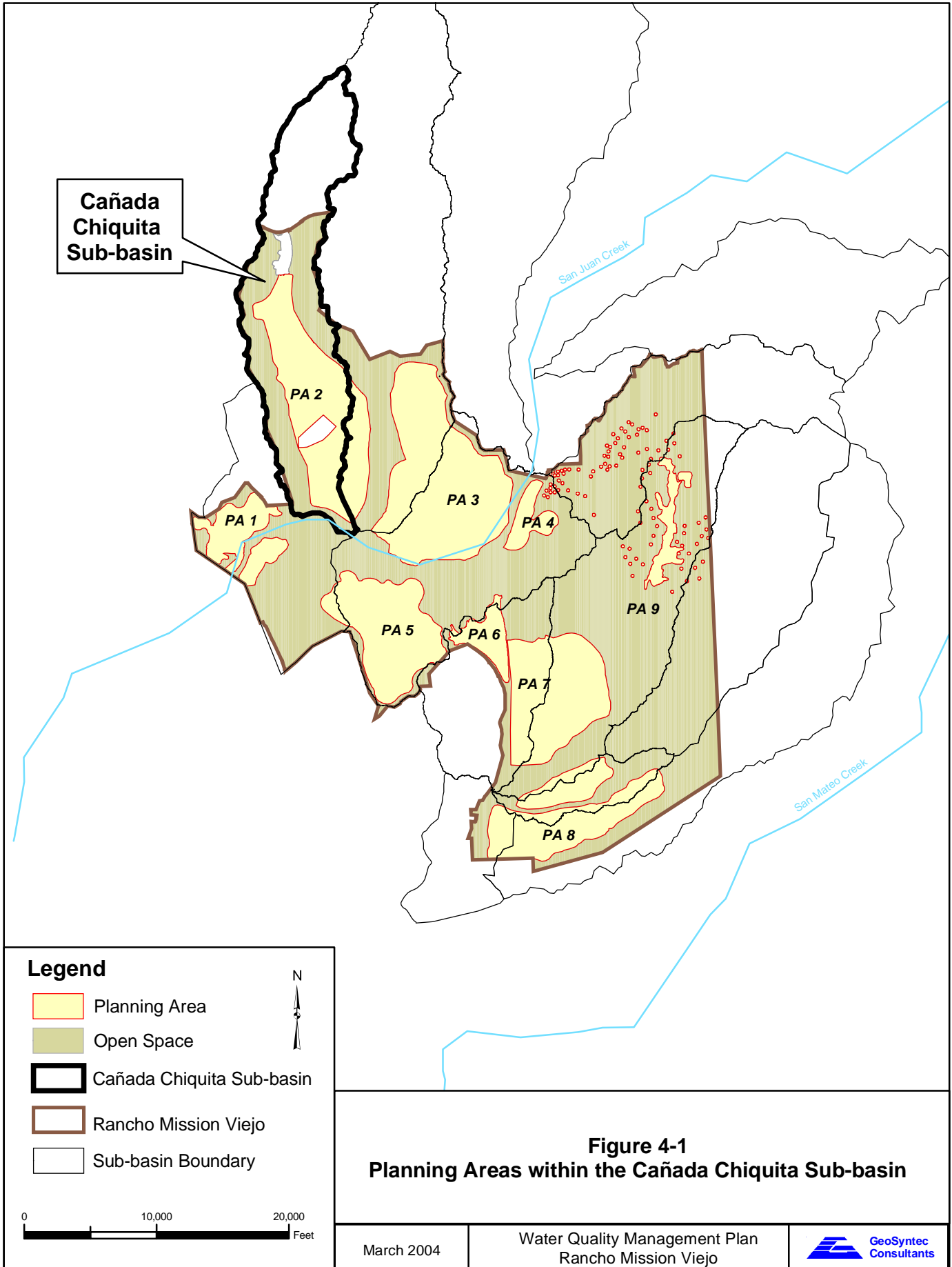
Soils in the main canyon are primarily sandy and soils on the uplands area adjacent to the Northrup-Grummond facility are erodible clays (NCC/SAMP Working Group, 2003). Elevations range from approximately 200 feet above MSL in the creek bottom to approximately 300 feet on the mesa east of the creek. Upland habitats are dominated by annual grassland and small patches of coastal sage scrub and southern cactus scrub. A small patch of native grassland is present in the northeast corner of the area that overlaps with native grasslands in the Gabino and Blind Canyon Sub-basins. Riparian habitats in lower Cristianitos Creek include southern coast live oak forest and woodland, southern sycamore riparian woodland, southern willow scrub, arroyo willow riparian forest, and mule fat scrub.

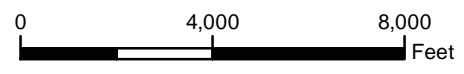
The sub-basin within the RMV boundary is mostly undeveloped, aside from a portion of the Northrup-Grummond facility and roadway. A significant amount of generally developed area exists within the sub-basin outside of the RMV boundary.

Alternative B-4 proposes 140 acres of general development, 5 acres of non-reserve open space, and 144 acres of reserve open space within the Lower Cristianitos Sub-basin. The general development land use is associated with Planning Area 8, which overlays the Lower Cristianitos, Gabino, Blind, and Talega Sub-basins. Grading plans for the B-4 alternative would redirect approximately 40 acres of the Lower Cristianitos Sub-basin into the Talega Sub-basin and would redirect approximately 3 acres of the Blind Sub-basin into the Lower Cristianitos Sub-basin, for a net gain of 37 acres in Lower Cristianitos.

Alternative B-9 includes 32 acres of general development, 55 acres of non-reserve open space, and 200 acres of reserve open space within the Lower Cristianitos Sub-basin.

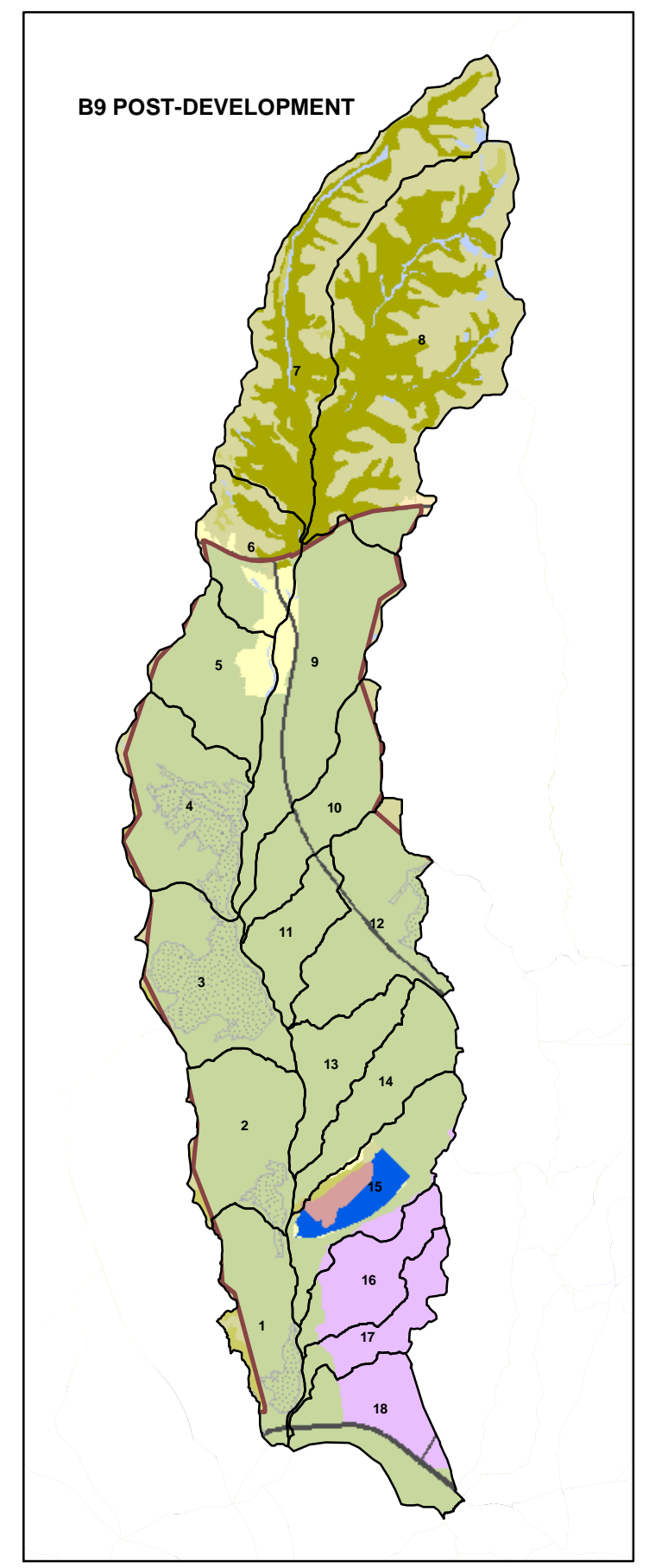
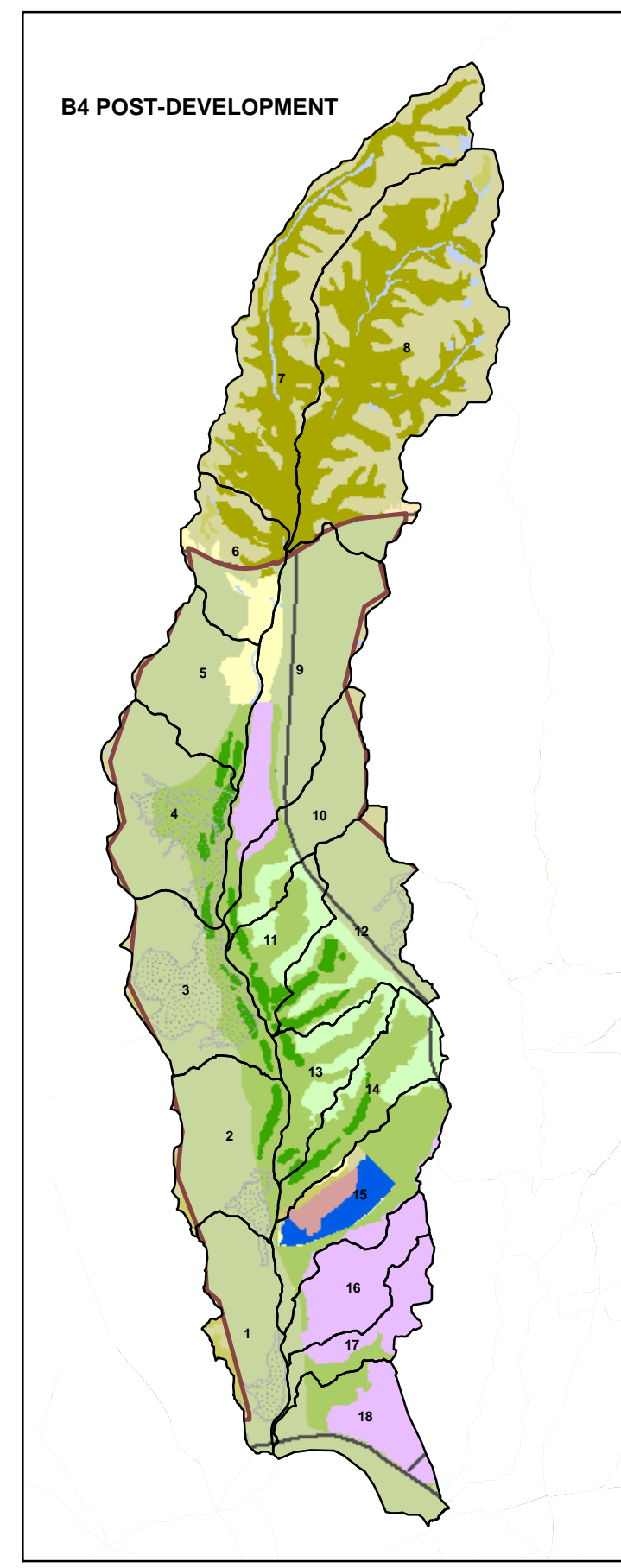
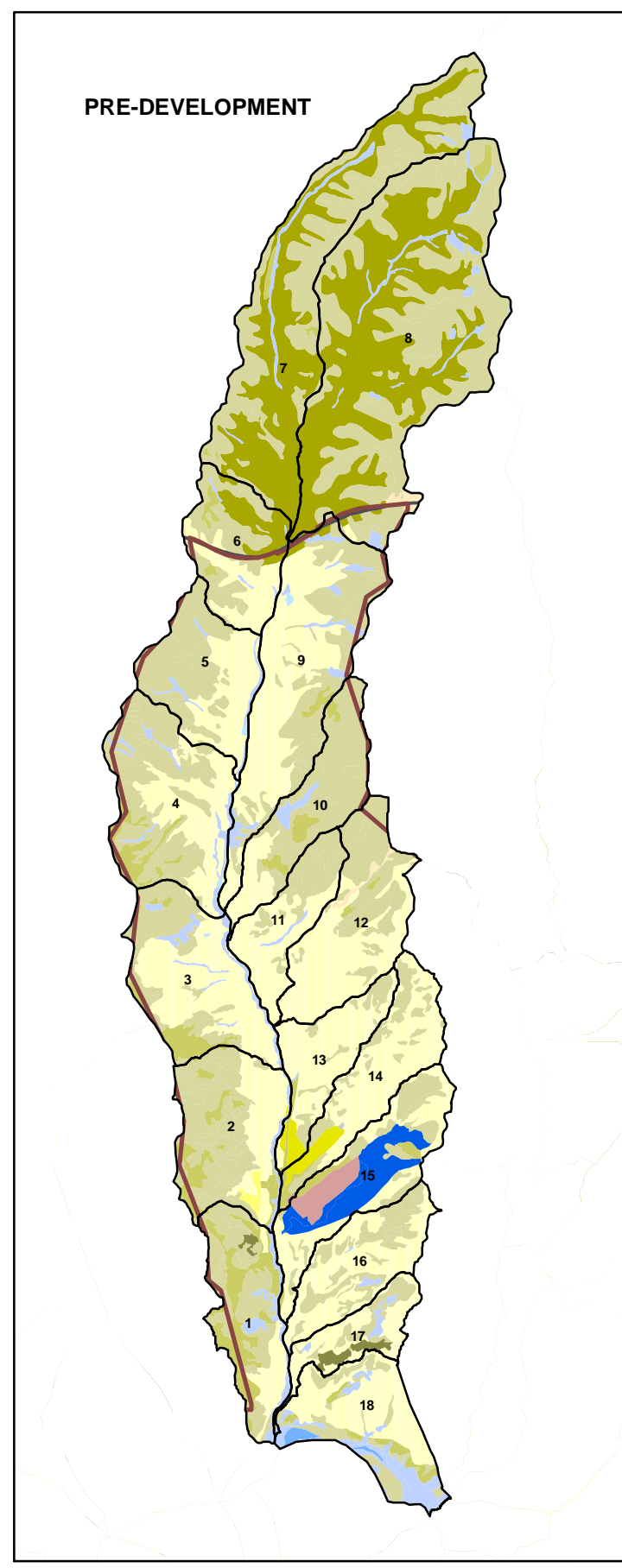
The planning recommendations set forth in the *Draft Watershed and Sub-basin Planning Principles* for this sub-basin include protection of the integrity of arroyo toad populations in lower Cristianitos Creek by maintaining current hydrologic conditions. Under both the B-4 and B-9 alternative, the developed area proposed within this sub-basin will drain to a combined control system similar to those proposed in the Blind and Talega Sub-basins (Blind-1 and Blind-3), that include treatment in an extended detention basin followed by infiltration in the sandy soils in the main canyon. This system will mimic the current hydrologic conditions from this drainage area.



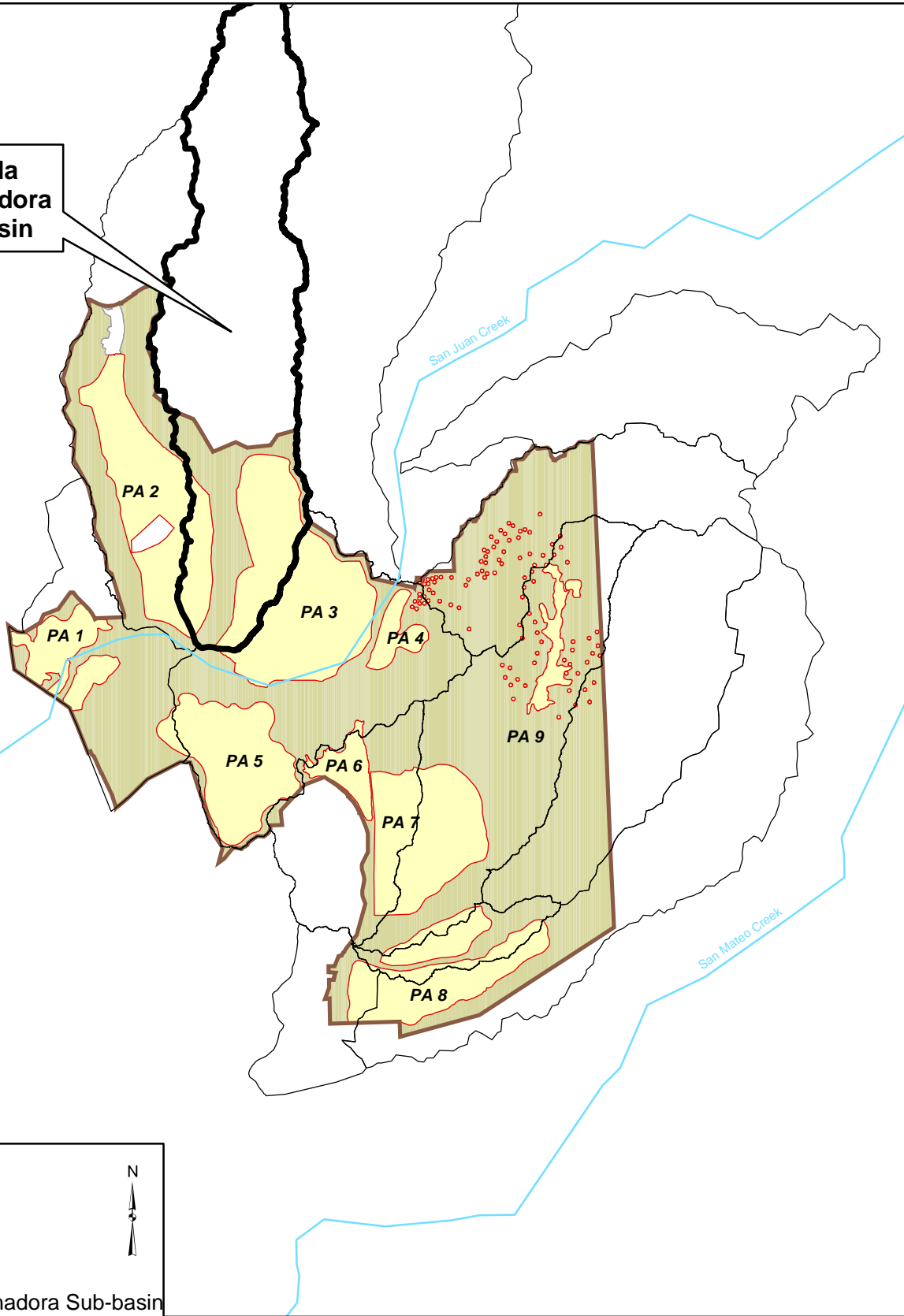


**Figure 4-2**  
**Pre- and Post-Development**  
**Land Uses in the**  
**Cañada Chiquita Sub-basin**






Water Quality Management Plan  
 Rancho Mission Viejo

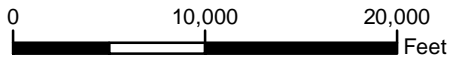


**Cañada Gobernadora Sub-basin**



**Legend**

-  Planning Area
-  Open Space
-  Cañada Gobernadora Sub-basin
-  Rancho Mission Viejo
-  Sub-basin Boundary



**Figure 4-3**  
**Planning Areas within the Cañada**  
**Gobernadora Sub-basin**

March 2004

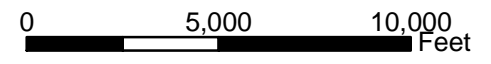
Water Quality Management Plan  
Rancho Mission Viejo



**Legend**

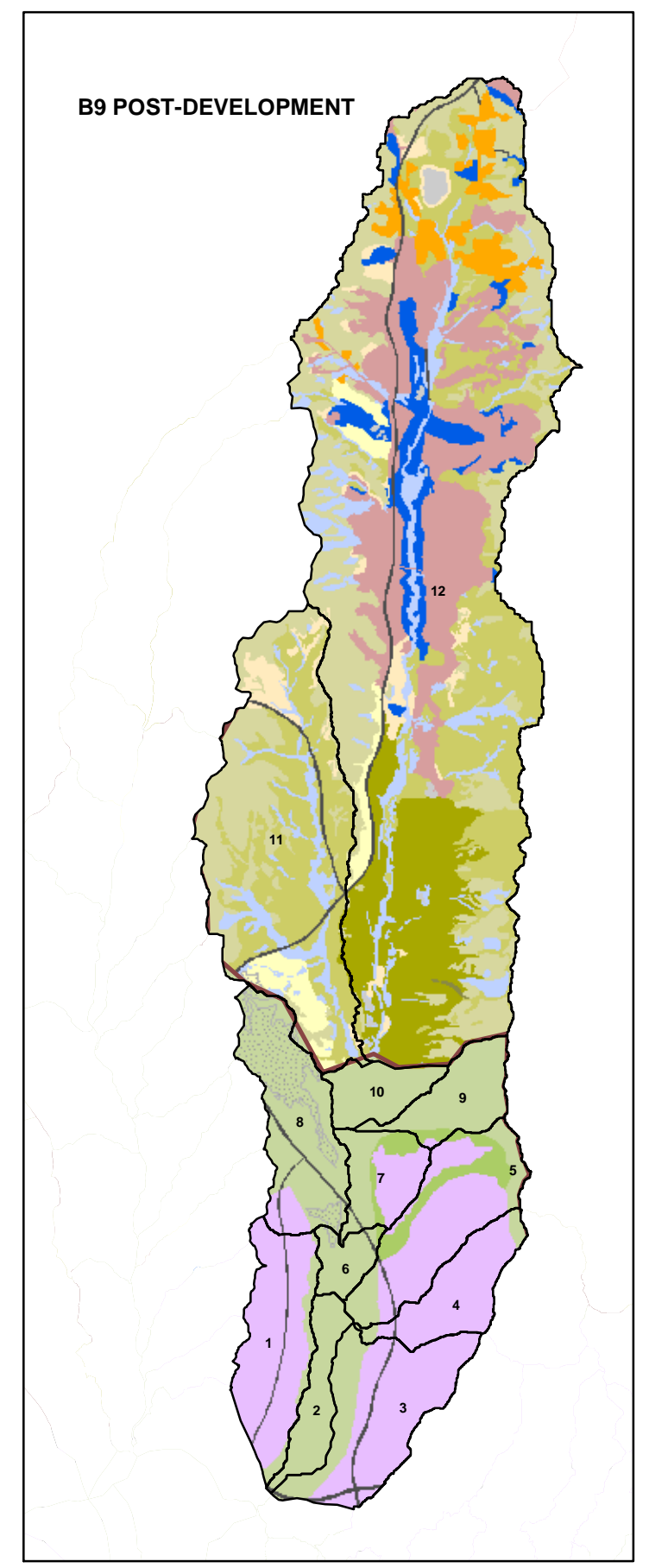
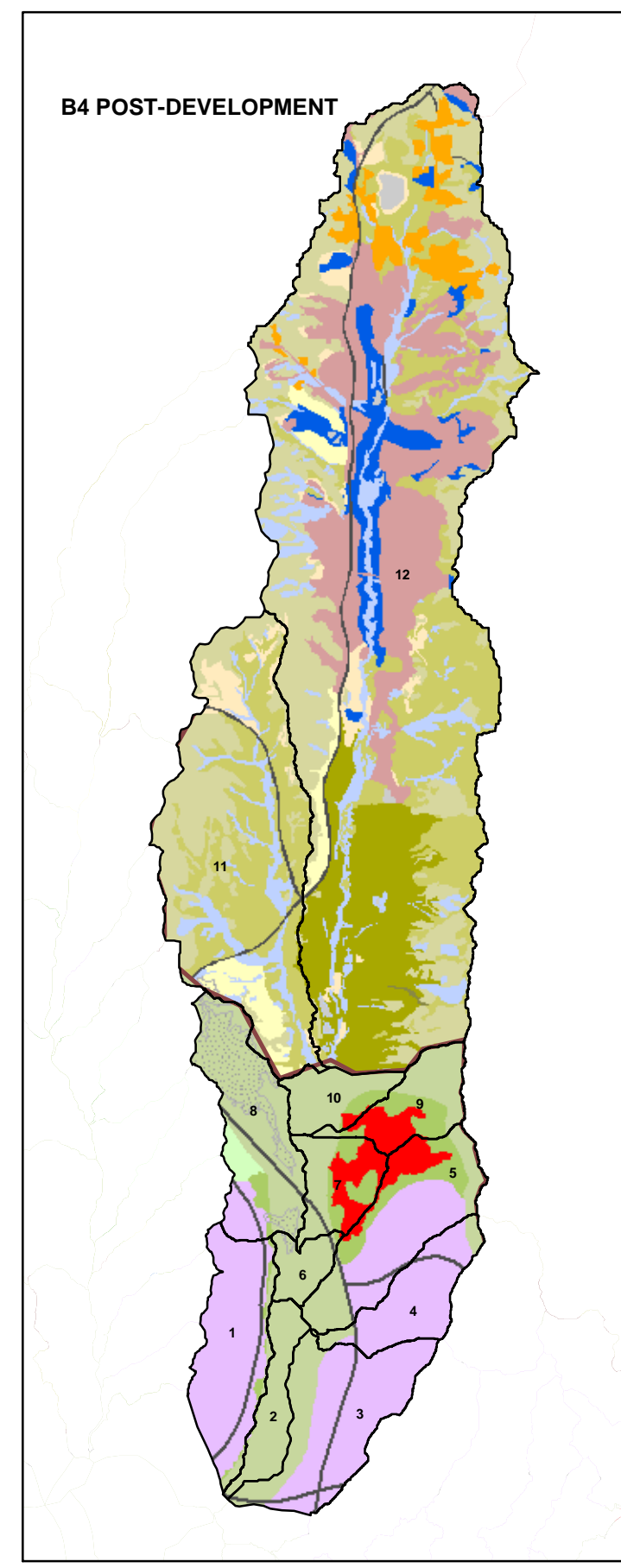
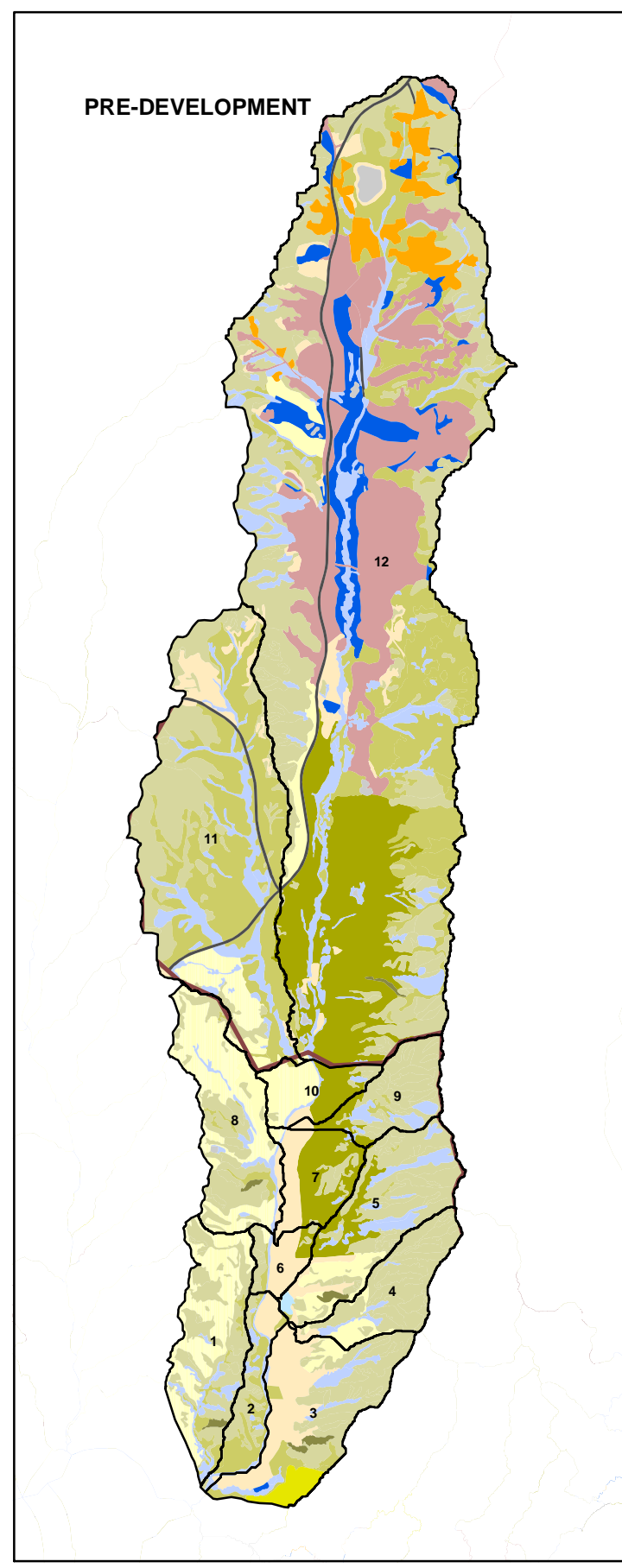
**Land Use**

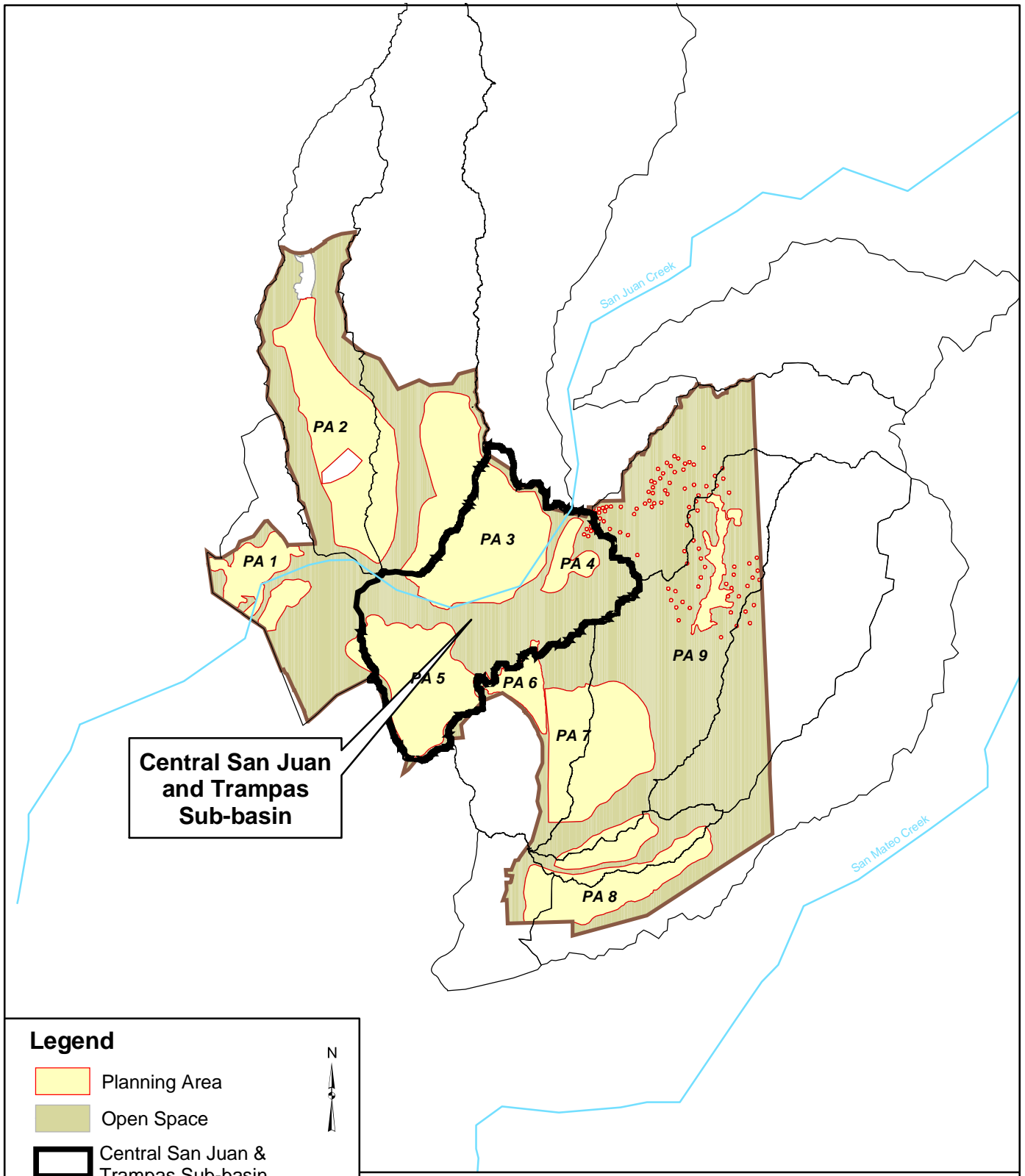
- General Agriculture
- Orchards
- Nurseries
- Barren
- Dunes
- Native Vegetation
- Grassland
- Forest
- Non Reserve Open Space
- Reserve Open Space
- Meadow/Marsh
- Riparian & Willow
- Streams & Creeks
- Parks
- Proposed Developed Area
- Existing Developed Area
- Casitas
- Estates
- Rural Residential
- Golf Residential
- Golf Resort
- Golf Planned
- Quarry
- Rocks, Cliffs & Outcrop
- Transportation
- Catchment Boundary
- Rancho Mission Viejo Boundary
- Restoration Area



**Figure 4-4**  
**Pre- and Post-Development**  
**Land Uses in the**  
**Cañada Gobernadora Sub-basin**

Water Quality Management Plan  
 Rancho Mission Viejo

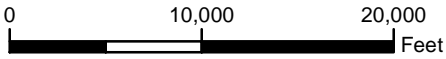




Central San Juan  
and Trampas  
Sub-basin

**Legend**

- Planning Area
- Open Space
- Central San Juan & Trampas Sub-basin
- Rancho Mission Viejo
- Sub-basin Boundary



**Figure 4-5**  
**Planning Areas within the Central San Juan**  
**and Trampas Sub-basin**

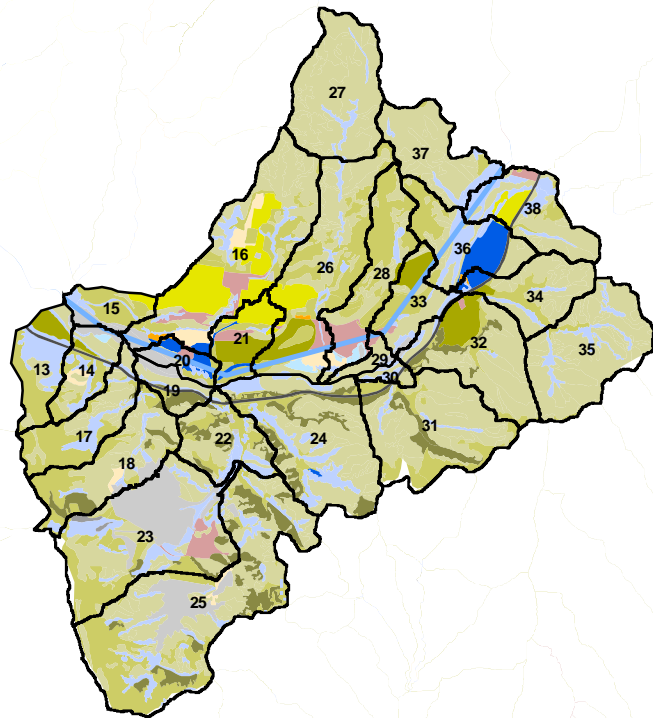
March 2004

Water Quality Management Plan  
Rancho Mission Viejo

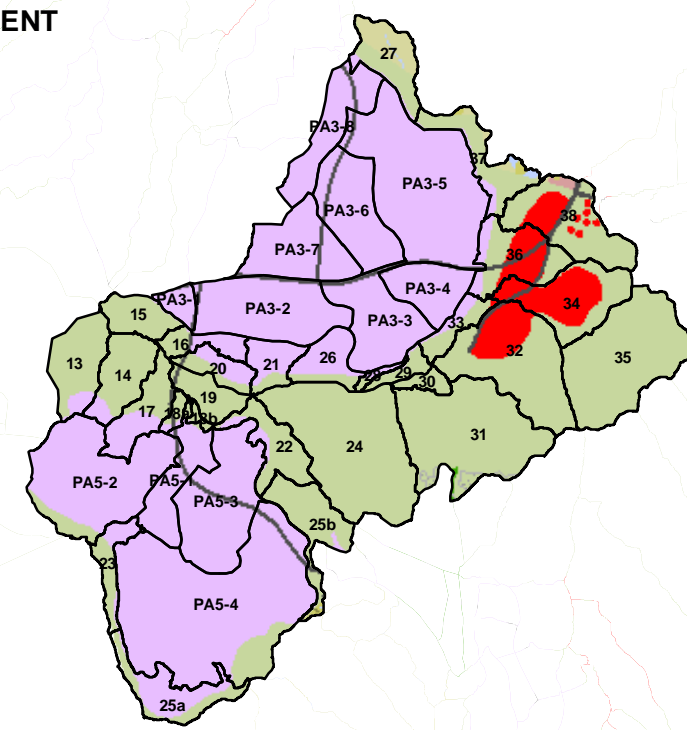


P:\GIS\RMV\project\WQMP\feb04\Fig4-5.mxd : P:\GIS\RMV\pdf\feb04\Fig4-5.pdf

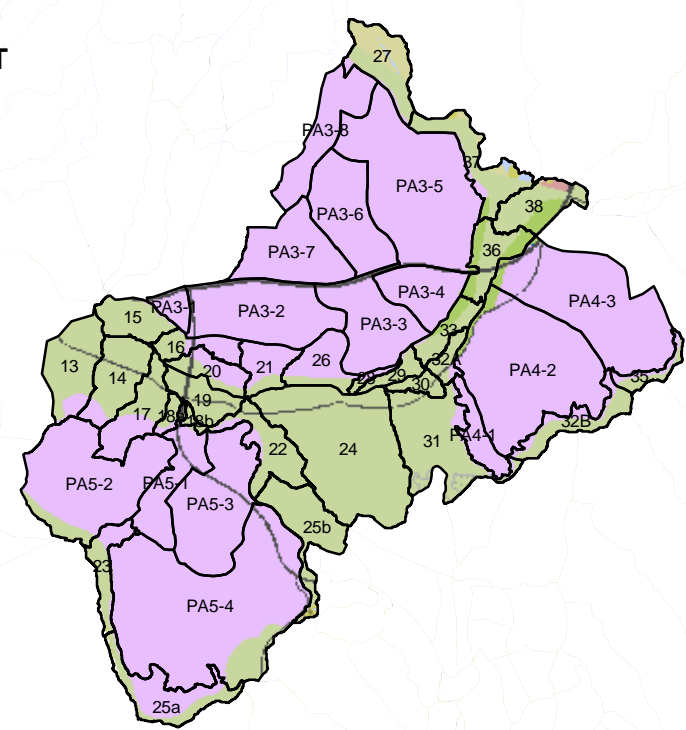
**PRE-DEVELOPMENT**



**B4 POST-DEVELOPMENT**



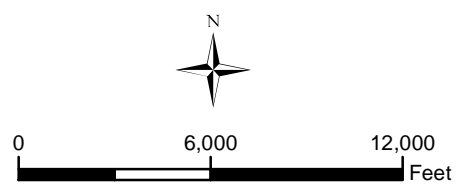
**B9 POST-DEVELOPMENT**



**Legend**

**Land Use**

General Agriculture	Proposed Development
Orchards	Existing Developed Area
Nurseries	Casitas
Barren	Estate
Dunes	Rural Residential
Native Vegetation	Meadow/Marsh
Grassland	Riparian & Willow
Forest	Streams & Creeks
Non Reserve Open Space	Parks
Reserve Open Space	Quarry
Golf Residential	Rocks, Cliffs & Outcrop
Golf Resort	Transportation
Golf Planned	
Restoration Area	
Catchment Boundary	

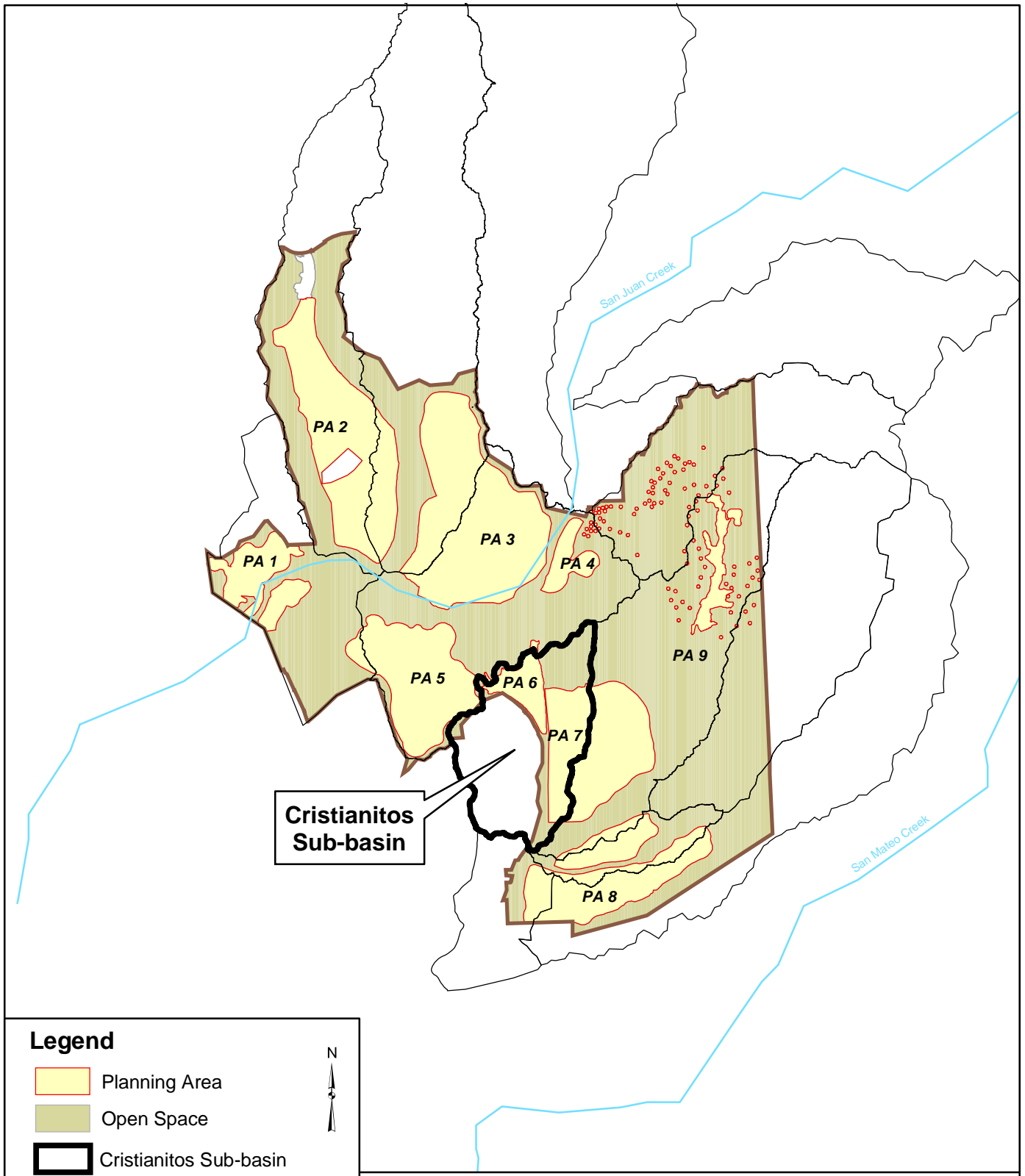


**Figure 4-6**  
**Pre- and Post-Development**  
**Land Uses in Central San Juan**  
**and Trampas Sub-basin**

Water Quality Management Plan  
 Rancho Mission Viejo

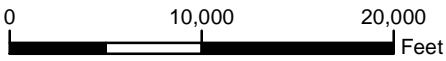






**Legend**

- Planning Area
- Open Space
- Cristianitos Sub-basin
- Rancho Mission Viejo
- Sub-basin Boundary



**Figure 4-7  
Planning Areas within the Cristianitos Sub-basin**

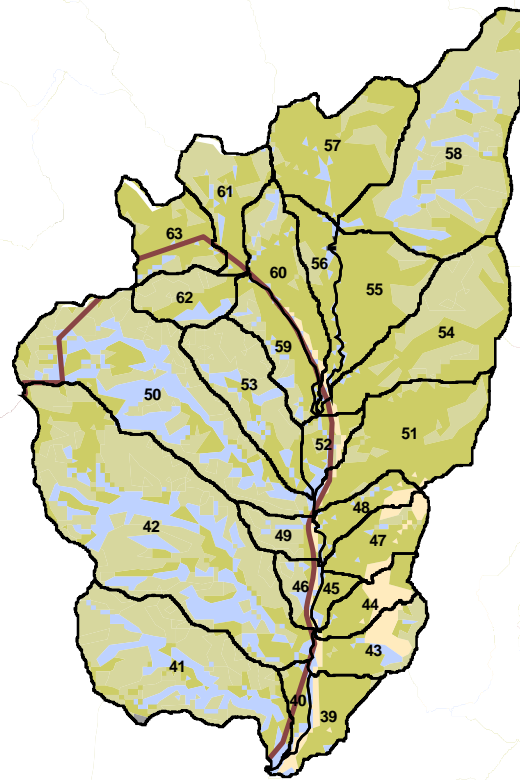
March 2004

Water Quality Management Plan  
Rancho Mission Viejo

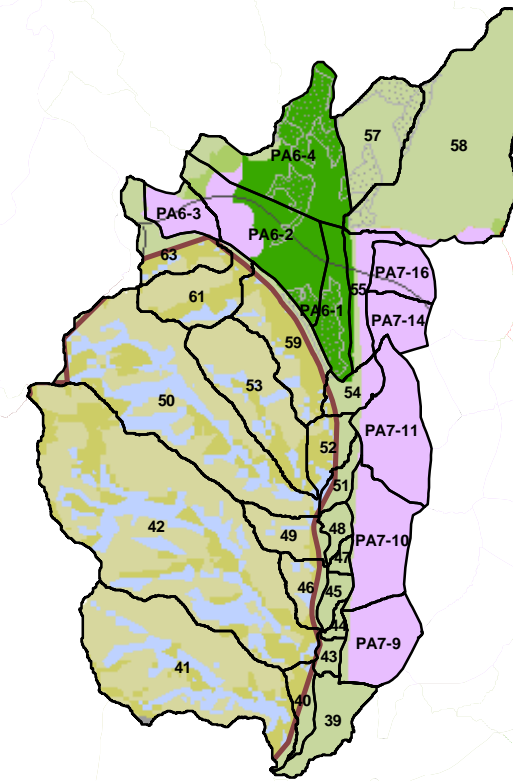


P:\GIS\RMV\project\WQMP\feb04\Fig4-7.mxd : P:\GIS\RMV\pdf\feb04\Fig4-7.pdf

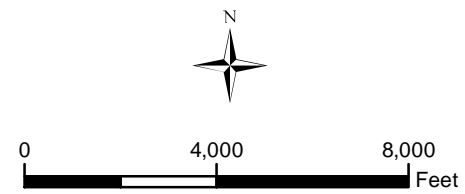
**PRE-DEVELOPMENT**



**B4 POST-DEVELOPMENT**



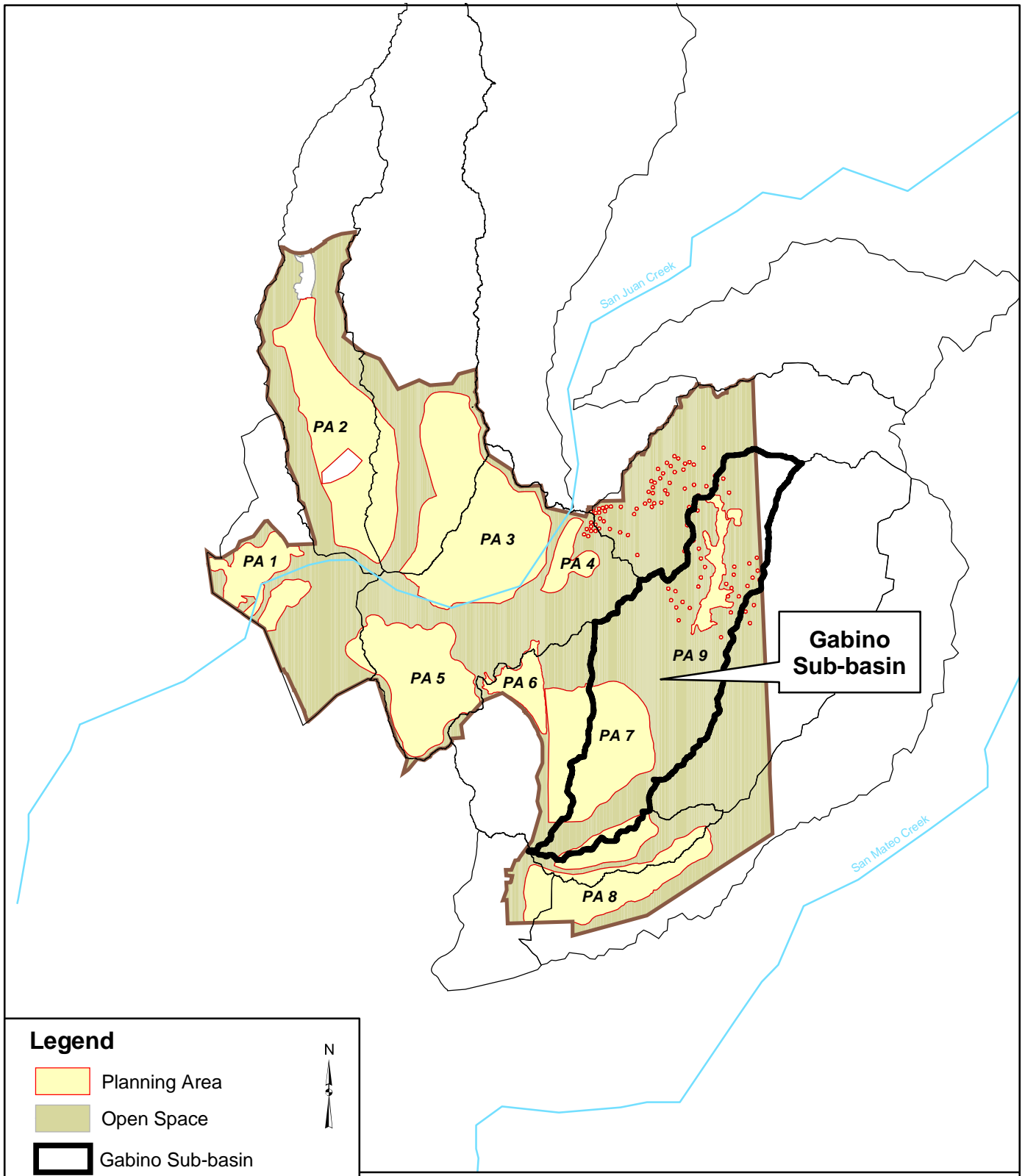
**B9 POST-DEVELOPMENT**



**Figure 4-8**  
Pre- and Post-Development  
Land Uses in the  
Cristianitos Sub-basin

Water Quality Management Plan  
Rancho Mission Viejo

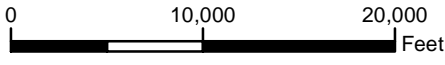




**Gabino Sub-basin**

**Legend**

- Planning Area
- Open Space
- Gabino Sub-basin
- Rancho Mission Viejo
- Sub-basin Boundary



**Figure 4-9  
Planning Areas within the Gabino Sub-basin**

March 2004

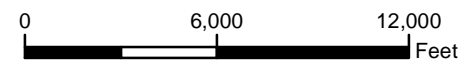
Water Quality Management Plan  
Rancho Mission Viejo



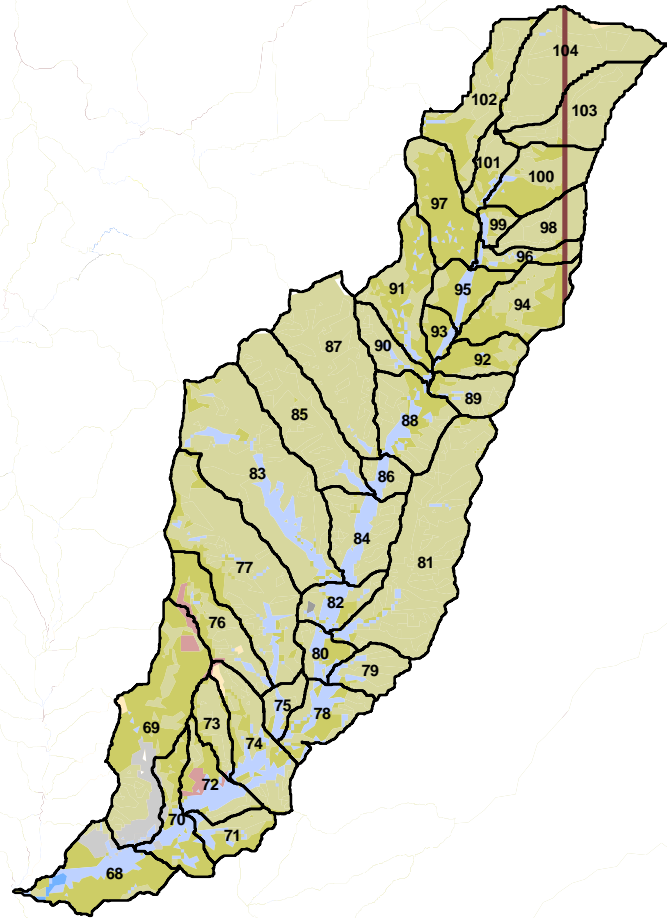
P:\GIS\RMV\project\WQMP\feb04\Fig4-9.mxd

**Land Use**

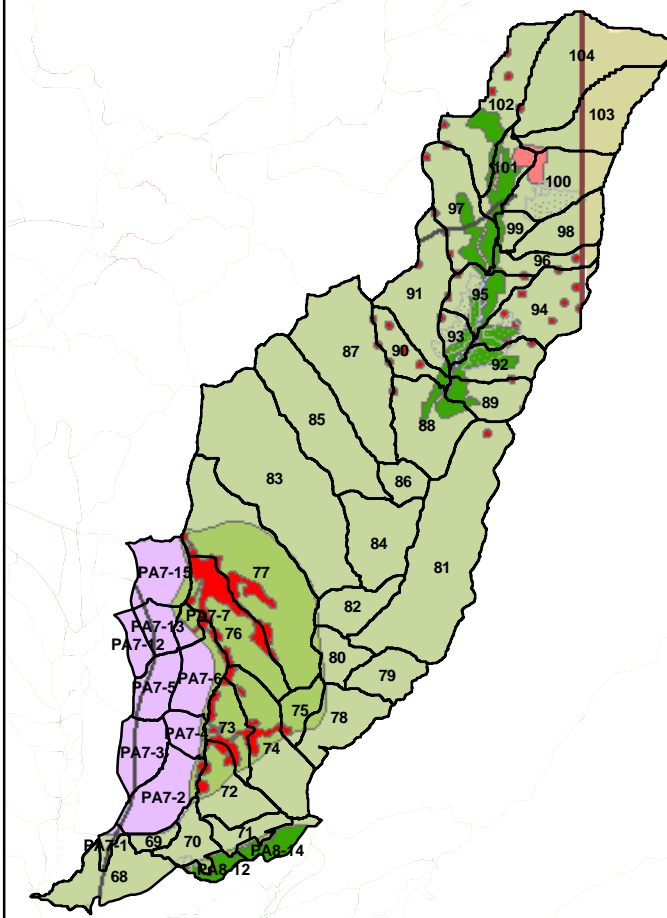
- General Agriculture
- Orchards
- Nurseries
  
- Barren
- Dunes
- Native Vegetation
- Grassland
- Forest
  
- Non Reserve Open Space
- Reserve Open Space
  
- Meadow/Marsh
- Riparian & Willow
- Streams & Creeks
- Parks
  
- Proposed Developed Area
- Existing Developed Area
- Casitas
- Estates
- Rural Residential
  
- Golf Residential
- Golf Resort
- Golf Planned
  
- Quarry
- Rocks, Cliffs & Outcrop
- Transportation
  
- Restoration Area
- Catchment Boundary
- Rancho Mission Viejo Boundary



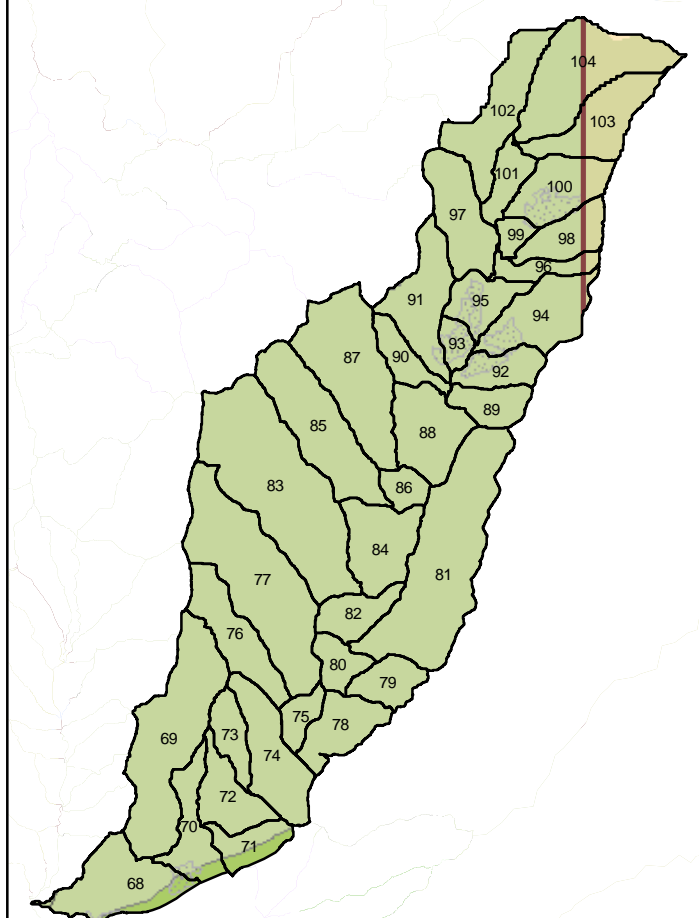
**PRE-DEVELOPMENT**



**B4 POST-DEVELOPMENT**



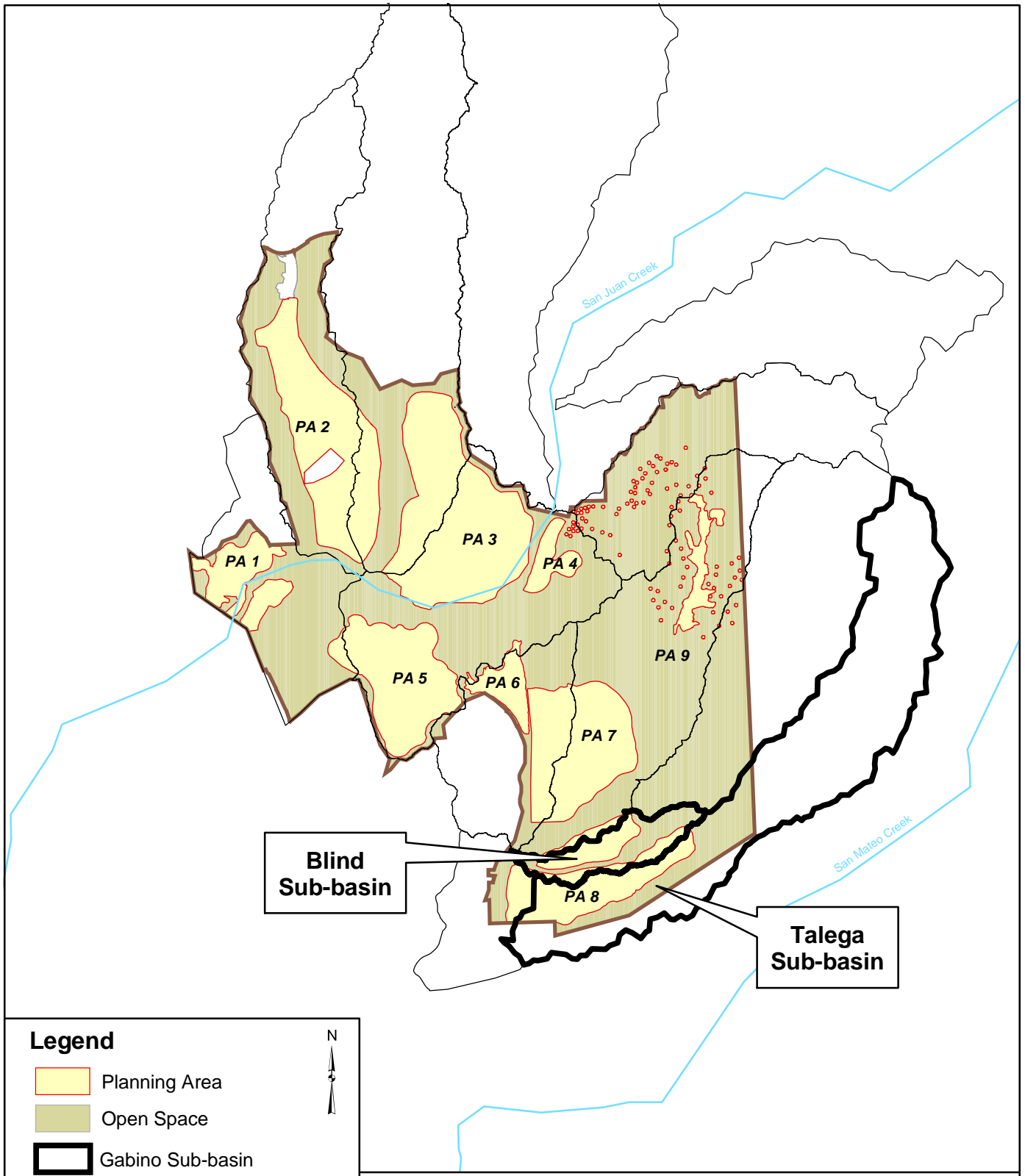
**B9 POST-DEVELOPMENT**



**Figure 4-10  
Pre- and Post-Development  
Land Uses in the  
Gabino Sub-basin**

Water Quality Management Plan  
Rancho Mission Viejo





**Legend**

- Planning Area
- Open Space
- Gabino Sub-basin
- Rancho Mission Viejo
- Sub-basin Boundary

N  
↑

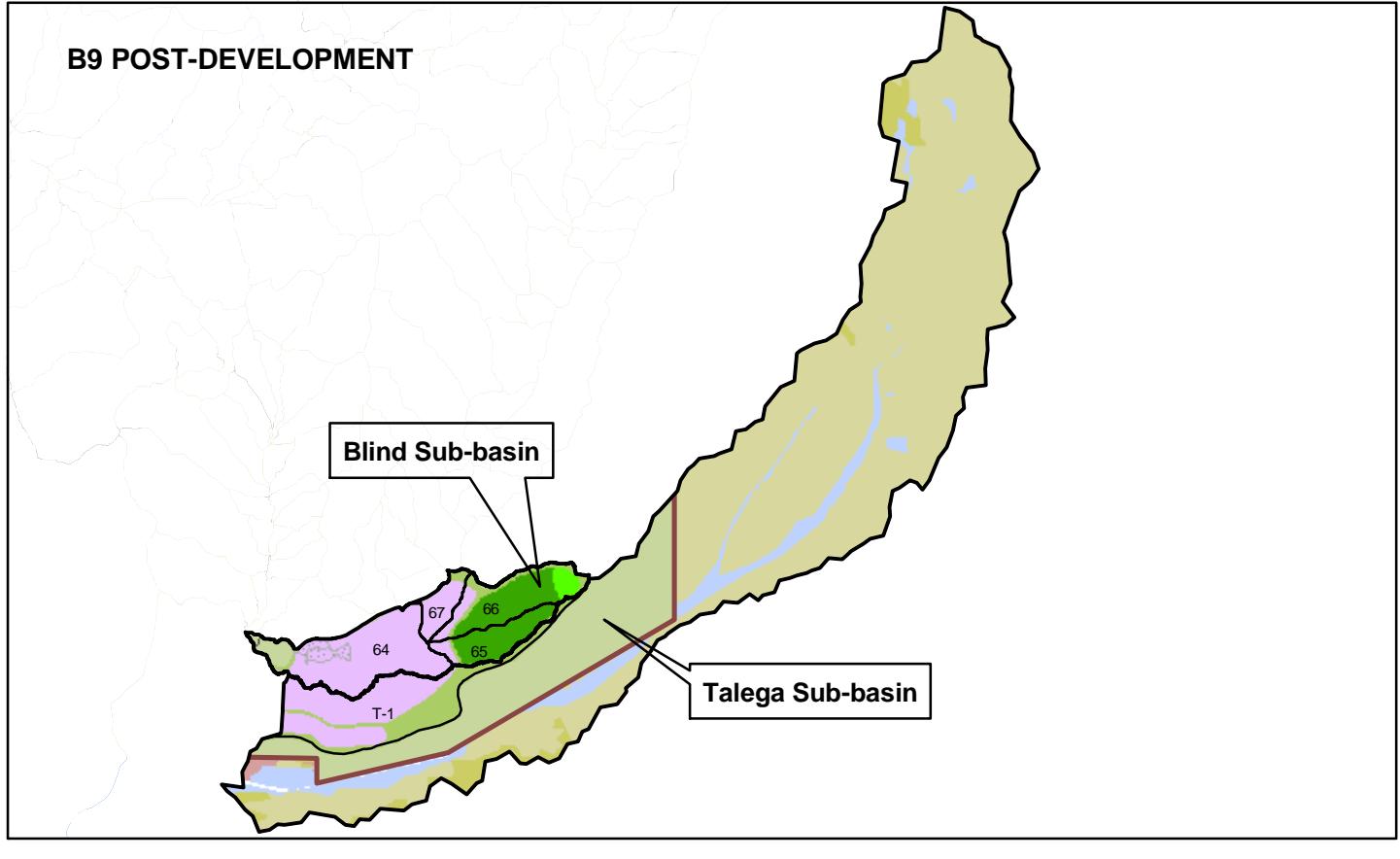
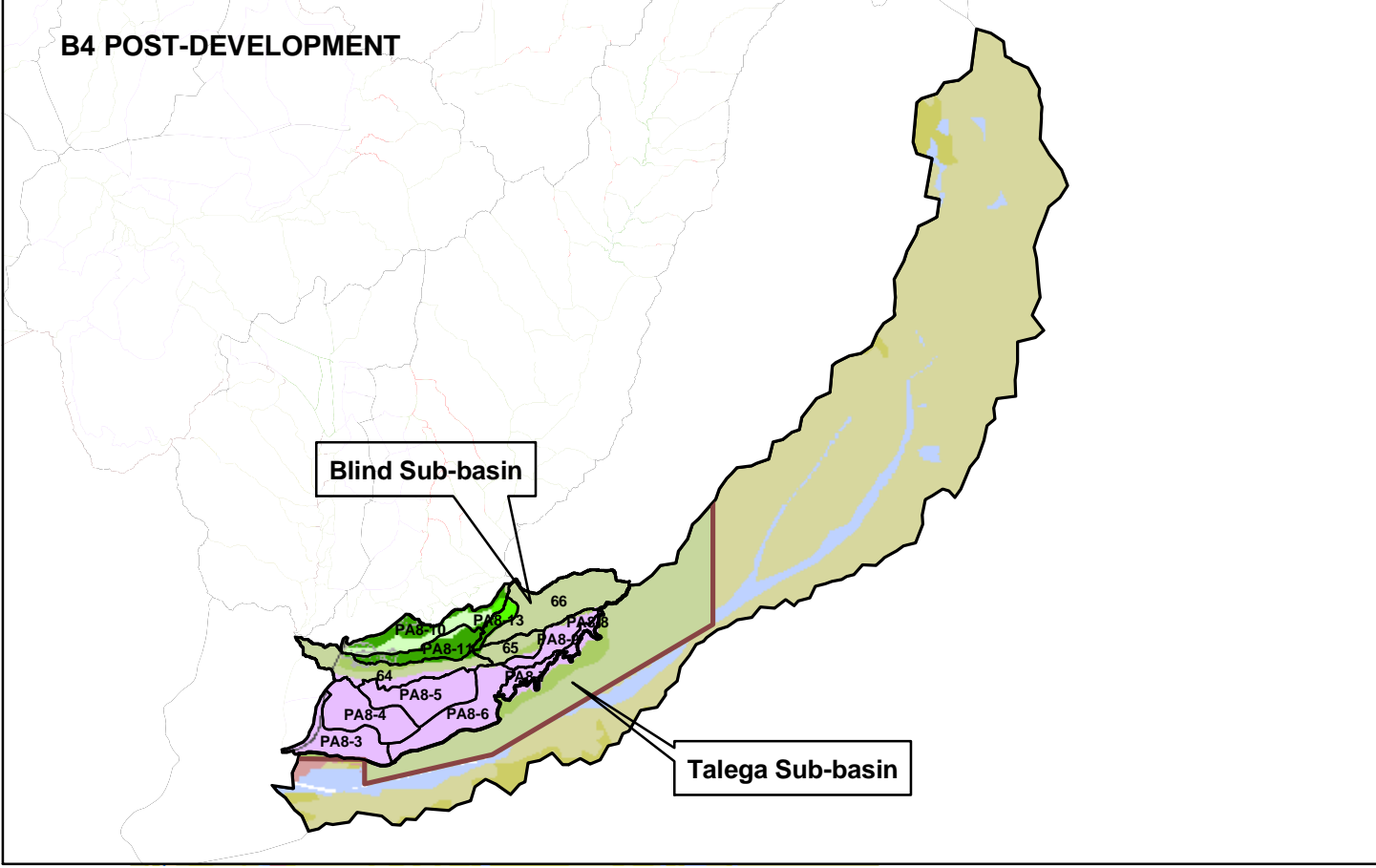
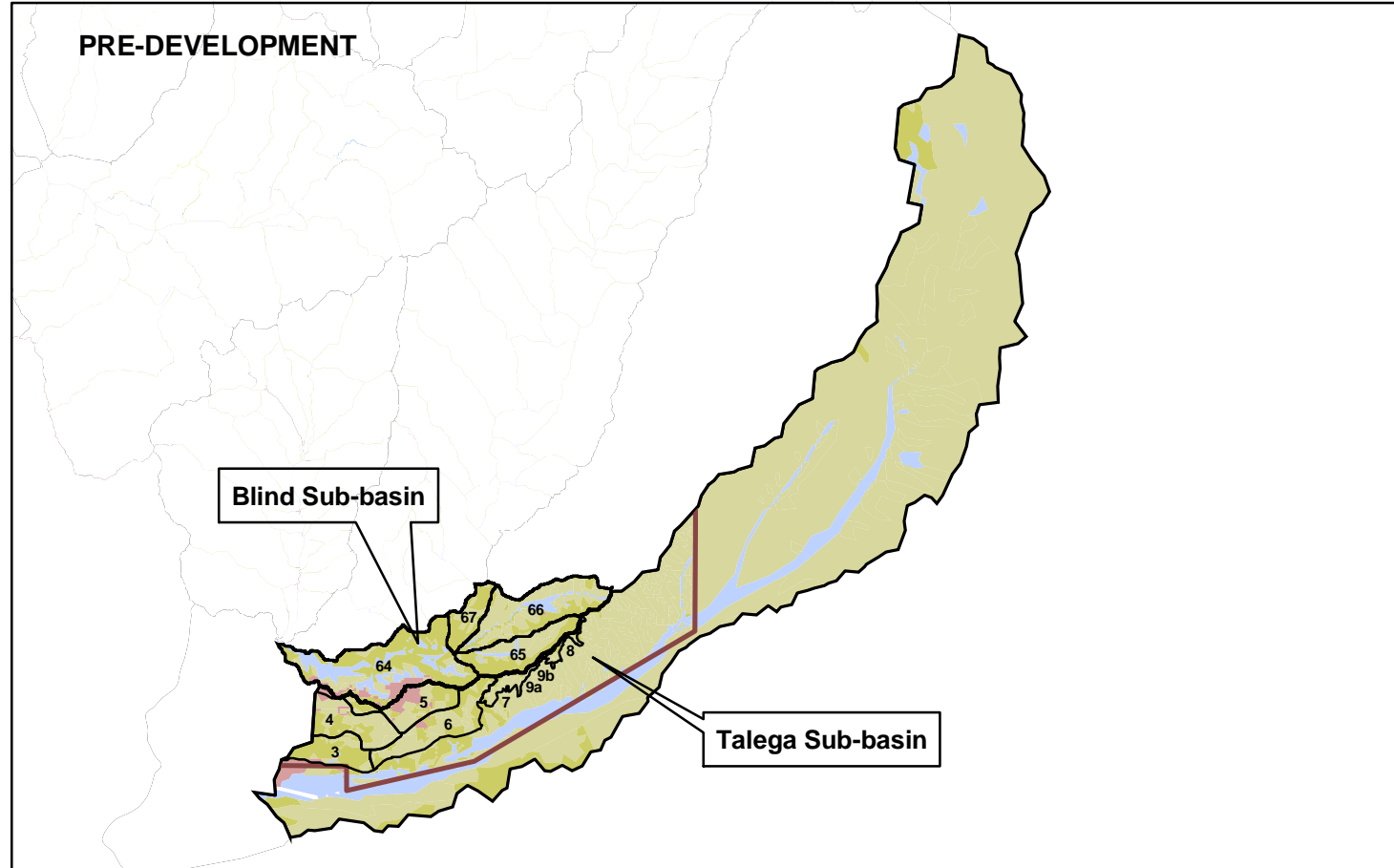
0      10,000      20,000  
Feet

**Figure 4-11**  
**Planning Areas within the Talega**  
**and Blind Sub-basins**

March 2004

Water Quality Management Plan  
Rancho Mission Viejo





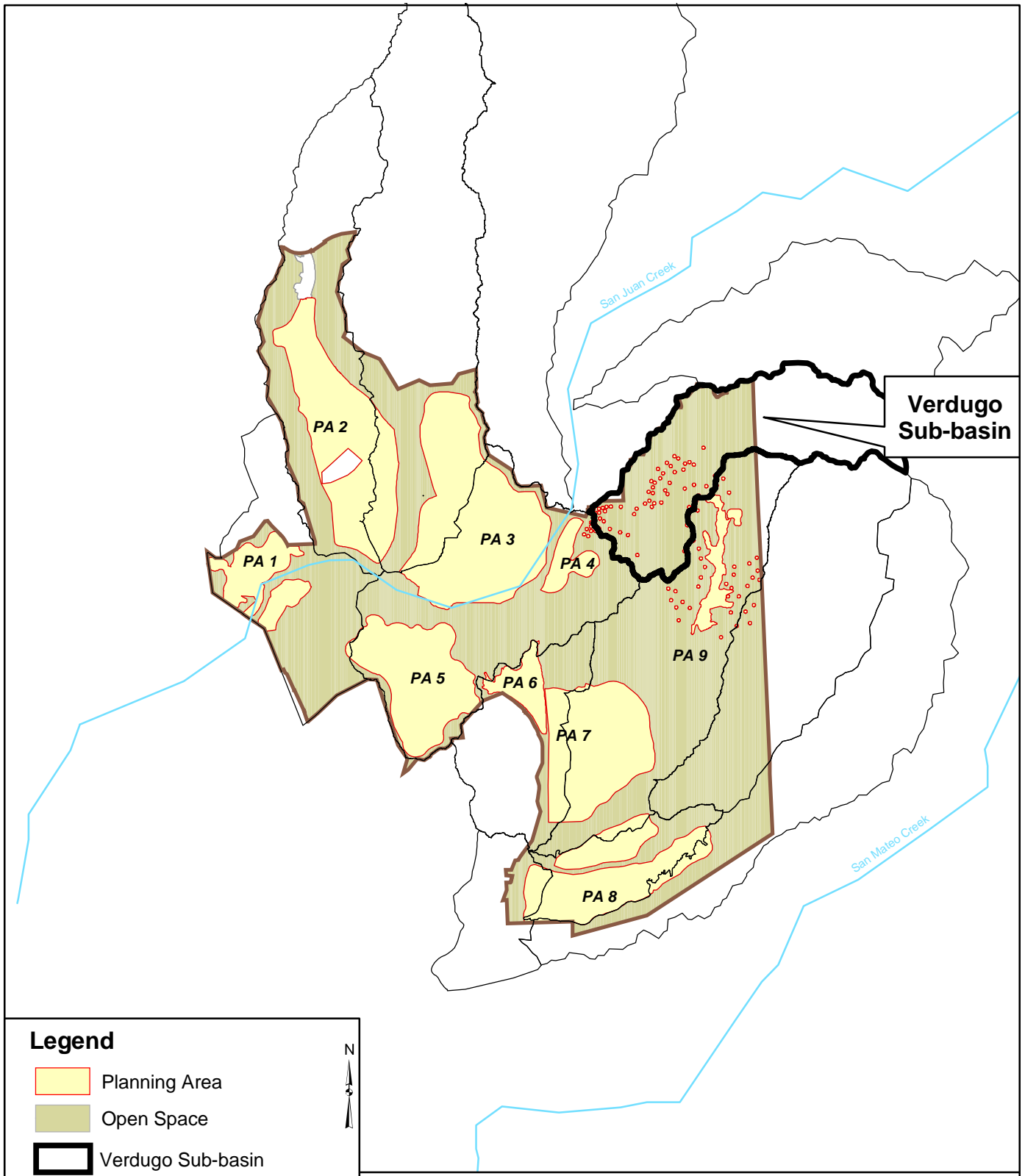
**Legend**

<b>Land Use</b>	
General Agriculture	Proposed Development
Orchards	Existing Developed Area
Nurseries	Casitas
Barren	Estate
Dunes	Rural Residential
Native Vegetation	Meadow/Marsh
Grassland	Riparian & Willow
Forest	Streams & Creeks
Non Reserve Open Space	Parks
Reserve Open Space	Quarry
Golf Residential	Rocks, Cliffs & Outcrop
Golf Resort	Transportation
Golf Planned	Restoration Area
Rancho Mission Viejo Boundary	Sub-basin Boundary
Rancho Mission Viejo Boundary	Catchment Boundary

**Figure 4-12**  
**Pre- and Post-Development**  
**Land Uses in the Talega**  
**and Blind Sub-basins**

Water Quality Management Plan  
 Rancho Mission Viejo

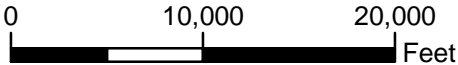




**Verdugo Sub-basin**

**Legend**

- Planning Area
- Open Space
- Verdugo Sub-basin
- Rancho Mission Viejo
- Sub-basin Boundary



**Figure 4-13  
Planning Areas within the Verdugo Sub-basin**

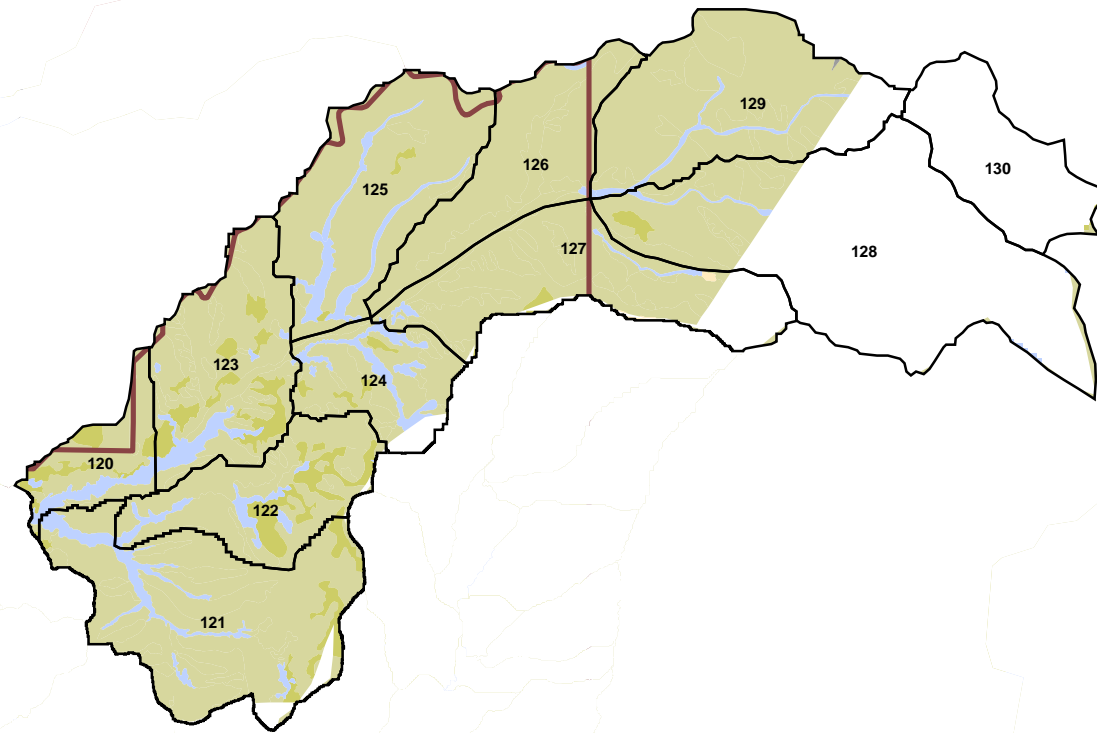
March 2004

Water Quality Management Plan  
Rancho Mission Viejo

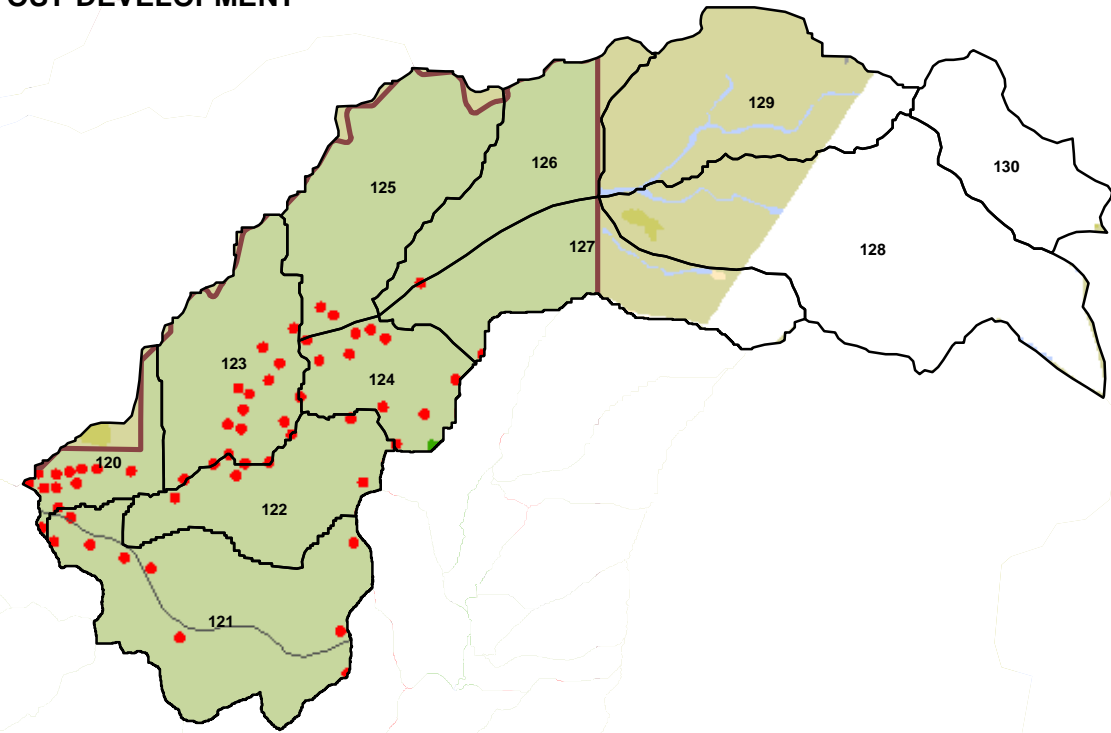


P:\GIS\RMV\project\WQMP\feb04\Fig4-13.mxd :: P:\GIS\RMV\pdf\feb04\Fig4-13.pdf

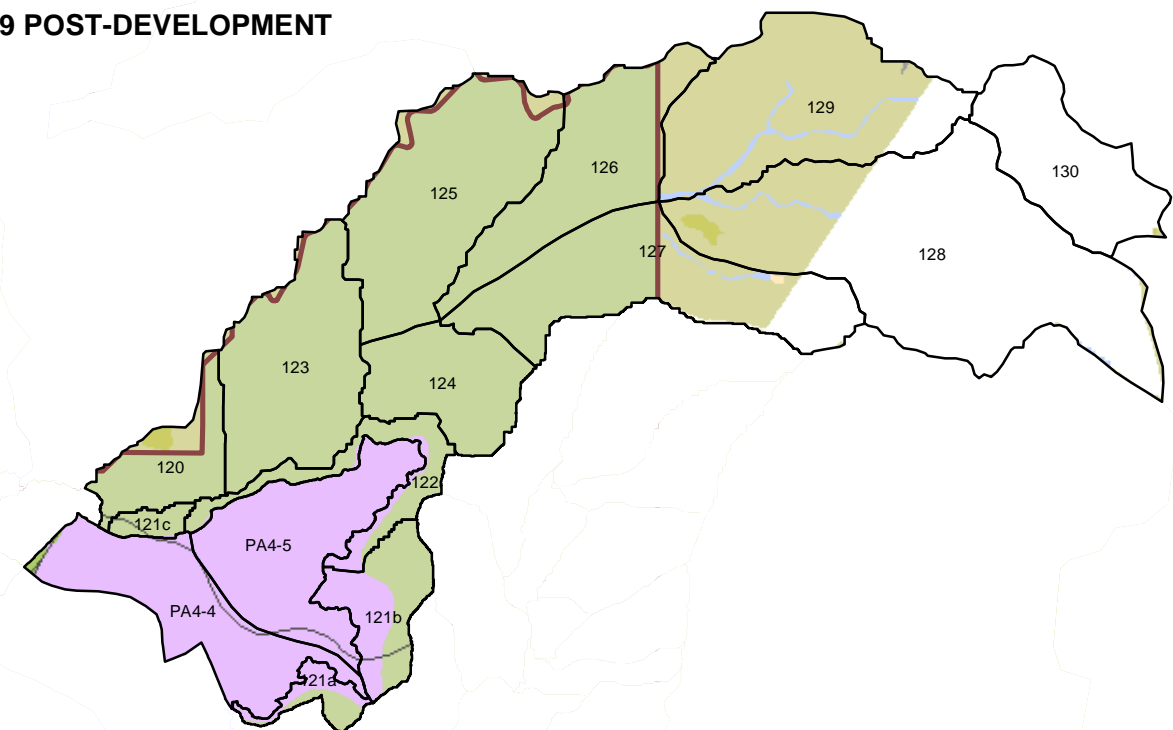
**PRE-DEVELOPMENT**



**B4 POST-DEVELOPMENT**

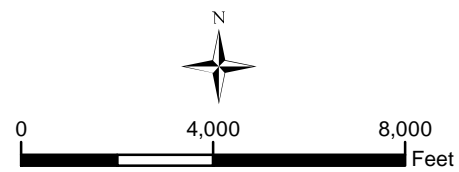


**B9 POST-DEVELOPMENT**



**Legend**

<b>Land Use</b>	
General Agriculture	Proposed Development
Orchards	Existing Developed Area
Nurseries	Casitas
Barren	Estate
Dunes	Rural Residential
Native Vegetation	Meadow/Marsh
Grassland	Riparian & Willow
Forest	Streams & Creeks
Non Reserve Open Space	Parks
Reserve Open Space	Quarry
Golf Residential	Rocks, Cliffs & Outcrop
Golf Resort	Transportation
Golf Planned	Restoration Area
Catchment Boundary	Rancho Mission Viejo Boundary

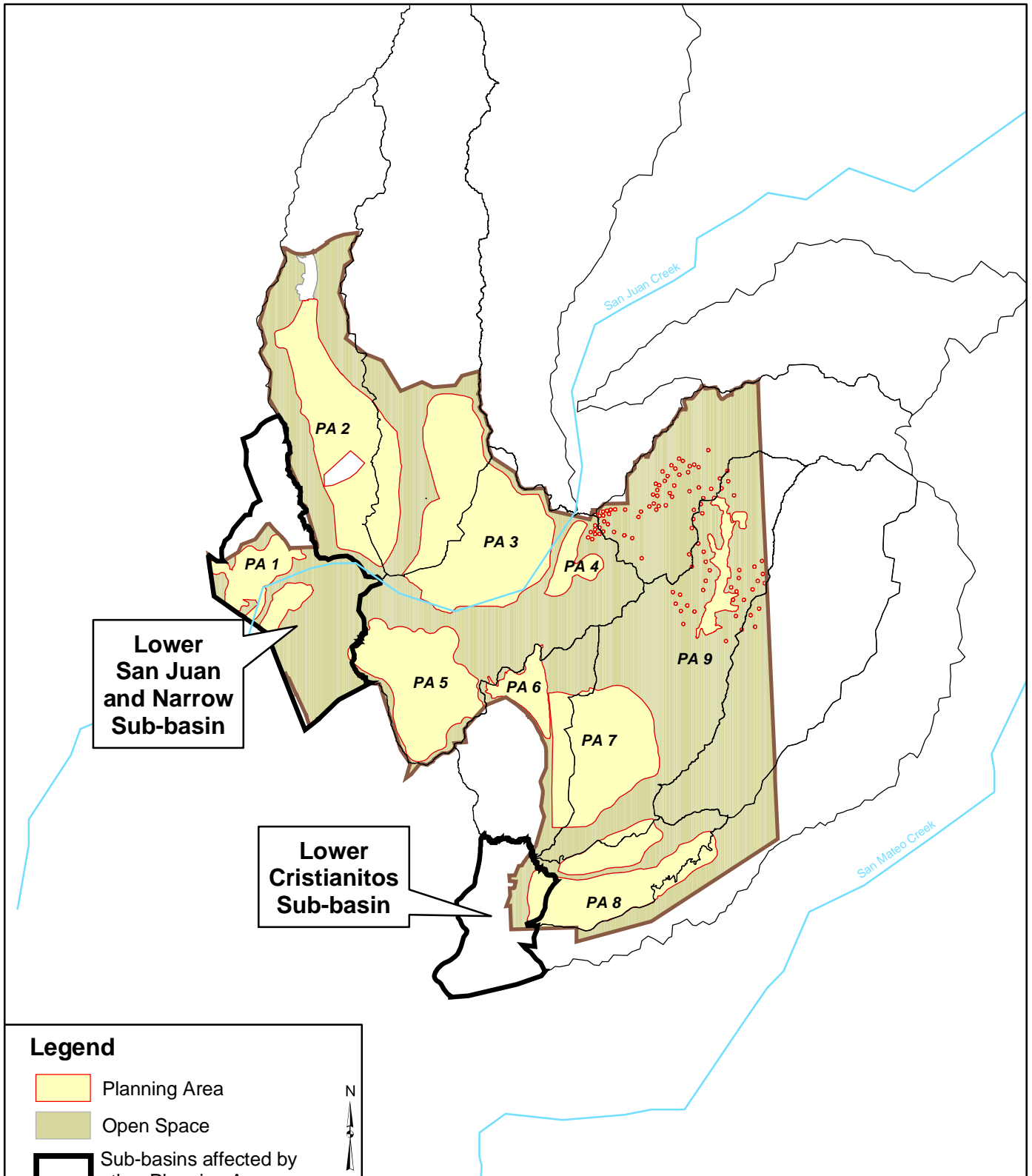


**Figure 4-14**  
Pre- and Post-Development  
Land Uses in the  
Verdugo Sub-basin

Water Quality Management Plan  
Rancho Mission Viejo







**Figure 4-15**  
**Sub-basins Affected by**  
**Planning Areas 1 and 8A**

**Legend**

- Planning Area
- Open Space
- Sub-basins affected by other Planning Areas
- Rancho Mission Viejo
- Sub-basin Boundary

0      10,000      20,000  
 Feet

March 2004

Water Quality Management Plan  
 Rancho Mission Viejo



P:\GIS\RMV\project\WQMP\feb04\Fig4-15.mxd :: P:\GIS\RMV\pdf\feb04\Fig4-15.pdf

## **5 IMPACT ANALYSIS**

This chapter evaluates the impacts of the proposed alternatives on pollutants of concern and hydrologic conditions of concern taking into account the WQMP elements described in Chapter 4. In the preceding chapter, the site design features, source control measures, and combined control system facilities were referred to as “BMPs” consistent with the Local WQMP. In this chapter, the BMPs associated with the Conceptual WQMP are referred to as “Project Design Features” (PDFs), which is consistent with the LIP’s CEQA guidance. The significance of impacts is evaluated based on significance criteria and thresholds described in Chapter 2.

Certain impacts are more conveniently addressed for the development alternatives as whole, and are discussed in Section 5.1. Sub-basin specific impacts to hydrologic conditions of concern and other pollutants of concern are described in subsequent sections.

Impacts are addressed for most of the sub-basins in the B-4 alternative based on sub-basin specific hydrologic and water quality modeling. For the majority of the B-9 alternative and two sub-basins in the B-4 alternative, impacts are addressed based on extrapolation of modeling results, literature information on the effects of urbanization on water quality, and professional judgment.

It should be noted that the hydrologic and water quality modeling only takes into account the structural facilities in the combined control system, including the detention and infiltration basins, the diversions, and the non-domestic water supply reservoirs. The modeling also takes into account anticipated irrigation controls. The models do not take into account site design and source control BMPs that will limit runoff and prevent the introduction of pollutants in the runoff. Such controls include litter programs, pesticide application management, street sweeping, and other maintenance operations. In this respect, the model predictions are likely to overestimate the effects of the proposed development on hydrology and water quality.

### **5.1 GENERALIZED IMPACTS**

This section discusses those impacts that can be addressed for the proposed alternatives as a whole, including impacts to certain pollutants of concern, groundwater impacts, and construction phase impacts. Discussion under general impacts also avoids replication of similar issues in subsequent sections.

#### **5.1.1 Selected Pollutants of Concern**

The assessment of impacts to solids, nutrients and trace metals was conducted with the aid of a water quality model. Necessary inputs to the model include statistically reliable and representative measured data that characterizes runoff water quality from a variety of land use types, and characterizes the effectiveness of BMPs. Such data are not available for the entire suite of pollutants of concern. Consequently the assessment of impacts to other pollutants of concern, including bacteria, pesticides, hydrocarbons, and trash and debris, was analyzed

qualitatively. The reasons that such data do not exist for each of these pollutants are discussed below.

- Actual human pathogens are usually not directly measured in stormwater monitoring programs because of the difficulty and expense involved. Rather, indicator bacteria such as fecal coliform are measured. Most indicators are not very reliable for stormwater conditions, in part because stormwater tends to mobilize pollutants from many sources, some of which contain non-pathogenic bacteria. For this reason, and because holding times for bacterial samples are necessarily short, stormwater programs collect single grab samples for pathogen indicators versus flow composite samples that potentially could produce more reliable estimates of averages.
- Various forms of hydrocarbons are common constituents associated with urban runoff; however, these constituents are difficult to measure because of laboratory interference effects, sample collection challenges (hydrocarbons tend to coat sample bottles), and they are typically measured with single grab samples, making it difficult to develop reliable Event Mean Concentrations (EMCs) based on collecting and analyzing flow composite samples.
- Pesticides in urban runoff are often at concentrations that are below detection limits for most commercial laboratories; and therefore there are limited statistically reliable data on pesticides in urban runoff.

### ***Impacts to Pathogens***

Pathogens are viruses, bacteria, and protozoa that can cause illness in humans. Identifying pathogens in water is difficult as the number of pathogens is exceedingly small requiring sampling and filtering large volumes of water. Traditionally water managers have relied on measuring “pathogen indicators”, such as total and fecal coliform, as an indirect measure of the presence of pathogens. Although such indicators were considered reliable for sewage samples, indicator organisms are not necessarily reliable indicators of viable pathogenic viruses, bacteria, or protozoa in stormwater. One reason for this is that coliform bacteria, in addition to being found in the digestive systems of warm-blooded animals, are also found in plants and soil; and pathogen indicators can multiply in the environment if the substrate, temperature, moisture, and nutrient conditions are suitable.

There are numerous natural and anthropogenic sources of pathogen indicators. Natural sources include birds and other wildlife. Anthropogenic sources include domesticated animals and pets, and human sources that may be introduced via poorly functioning septic systems, cross-connections between sewer and storm drains, and the direct utilization of outdoor areas for human waste disposal.

The Orange County Public Health Laboratory conducted a monitoring study in 1998 in the San Juan Creek watershed to help determine the sources of pathogen indicators during ***dry weather***

*conditions* (Moore et al, 2002). Monitoring stations were located in the ocean, in creeks in the San Juan Creek watershed, and in storm drains. One finding of the study was that “the highest concentrations of fecal coliforms and *Enterococcus* were found in the storm drains as compared to the creeks and ocean sampling sites. Samples taken from creek sites distant to human habitat also had low to moderate levels of bacteria, suggestive of fecal contamination by non-human sources.” Data obtained in San Juan Creek above the Ortega Highway (SJ30) indicated a log mean concentration for fecal coliform of about 300 colony forming units (CFUs) compared with a storm drain at La Novia Bridge (SJ07) where the concentration was about 1,400 CFUs.

Pathogen indicator concentrations during *wet weather* tend to be higher than during dry weather. The recent wet weather data collected by Wildermuth indicated that the geometric mean concentration of fecal coliform in San Juan Creek ranged from about 2,500 to 3,600 MPN/100mL. Geometric mean fecal coliform concentrations downstream of the Coto de Caza development in the Gobernadora Sub-basin were about 10,000 MPN/100 mL. The one dry weather fecal coliform sample taken below Coto De Caza was about 300 MPN/mL.

These data indicate that the development could potentially result in increased levels for pathogen indicators, especially during stormwater runoff conditions. The principal source of these pathogen indicators is likely pet wastes. Other sources of pathogens and pathogen indicators, such as cross connections between sanitary and storm sewers, are unlikely given modern sanitary sewer installation methods and inspection and maintenance practices.

The most effective means of controlling pet wastes as a source of pathogens is through source control, specifically education of pet owners, and providing products and disposal containers that encourage and facilitate cleaning up after pets.

The available data on the effectiveness of water quality basins for treating pathogens and pathogen indicators is limited. Caltrans has conducted some pathogen indicator monitoring of dry detention basins. These data indicate no statistically reliable reductions in effluent concentrations compared to influent concentrations. Therefore it is not assumed that levels of pathogen indicators during storm events will be reduced in the water quality basins.

However, the combined control system also includes an infiltration basin following the water quality basin. Infiltration is very effective in treating pathogens (DAMP Appendix E1), and therefore pathogens associated with dry weather flows, small storm flows, and the initial portion of large storm events will be effectively treated in the combined control system.

For those flows that bypass the infiltration basin, pathogen levels are not likely to meet the REC-1 standards (200 MPN/100 mL) for fecal coliform consistently. Meeting the REC-1 standard would require a level of treatment (e.g., disinfection) comparable to a municipal wastewater treatment plant which is considered beyond MEP for treating stormwater discharges.

The alternatives include a comprehensive list of source control BMPs for controlling pathogens that meet the Local WQMP and thus the MEP standard. Based on these considerations, the impact of the proposed alternatives on pathogens is considered a significant, unavoidable impact.

### ***Impacts to Petroleum Hydrocarbons***

The sources of oil, grease, and other petroleum hydrocarbons in urban areas include spillage and seepage of fossil fuels, discharge of domestic and industrial wastes, atmospheric deposition, and runoff (USEPA, 2002a). Runoff can be contaminated by leachate from asphalt roads, wearing of tires, deposition from automobile exhaust, and improper disposal of used oil and other auto-related fluids. Petroleum hydrocarbons, such as polycyclic aromatic hydrocarbons (PAHs), can accumulate in aquatic organisms from contaminated water, sediments, and food and are known to be toxic to aquatic life at low concentrations (USEPA, 2000a). Hydrocarbons can persist in sediments for long periods of time and result in adverse impacts on the diversity and abundance of benthic communities. Hydrocarbons can be measured as total petroleum hydrocarbons (TPH), oil and grease, or as individual groups of hydrocarbons, such as PAHs.

PAHs represent over 100 different chemicals and are found in coal tar, crude oil, creosote, and roofing tar; 16 PAHs have been placed on EPA's list of priority pollutants. Some PAHs are formed during the combustion of petroleum-based, wood, and paper products. The most likely sources of PAHs in stormwater runoff are vehicle combustion and leaks that could contribute PAHs in runoff from highways and parking lots. The majority of PAHs in stormwater adsorb to the organic carbon fraction of particulates in the runoff, including soot carbon generated from vehicle exhaust (Ribes et al, 2003). For example, a stormwater runoff study by Sharma et. al. (1997) found that the dissolved phase PAHs represented less than 11 percent of the total concentrations.

The median concentration of oil and grease summarized from a representative sample of NPDES MS4 monitoring programs nationwide was 3.1 mg/L for residential land use (Pitt et. al., 2003). The mean oil and grease value for three samples from high density single family residential land use reported in the Los Angeles County database was 1.3 mg/L; while TPH was also 1.3 mg/L in three samples (LA County, 2000). The reported mean oil and grease and TPH in four transportation land use samples was 3.1 mg/L. Oil and grease and TPH were not detected in 17 and 19 samples, respectively, out of a total of 21 samples taken of runoff from open space. These data indicate that hydrocarbons are only intermittently observed in runoff from residential areas, and when observed, the levels are relatively low. ***Dry weather*** discharges are primarily associated with illegal dumping, especially in areas where automobiles are maintained by homeowners that do not have a means of recycling used oil.

The Local WQMP rates detention basins and biofilters with a high or medium removal efficiency for oil and grease, and states that the effectiveness of infiltration basins and wetlands, according to the Local WQMP, is unknown. However, the California BMP Handbook attributes infiltration basins and constructed wetlands with high removal effectiveness for oil and grease, and medium

effectiveness for extended detention basins and vegetated swales (CASQA, 2003). The proposed combined control system, which is designed to treat pollutants through settling, adsorption, and biologically mediated processes in extended detention basins, wetlands, infiltration, and vegetated swales in series, should be very effective at treating PAHs and other petroleum hydrocarbons at the expected concentrations in runoff. On this basis, the effect of the proposed project on petroleum hydrocarbon levels is considered less than significant.

### ***Impacts to Pesticides***

Pesticides can be of concern from past as well as future activities. Where past farming practices involved the application of persistent pesticides such as DDT, there is the potential for mobilization during construction. Post-development application of pesticides for lawn, garden, and household use; common area landscaping; and golf courses may also introduce pesticides into the aquatic environment.

Wetlands Research Associates (WRA, 2002) identified pesticides and other toxic chemicals that could potentially impact endangered species known to be located within, downstream of, or adjacent to the RMV boundary - the arroyo toad and the southern steelhead. The following pesticides were identified as potential pollutants of concern: toxaphene, pentachlorophenol (PCP), and glyphosate. Toxaphene is an organochlorine pesticide that was very popular during the 1970s following the banning of DDT. It in turn was banned for all uses in 1990 (WRA, 2002). PCP is also a chlorinated pesticide that is primarily used as a preservative for wood products, and as a general herbicide. PCP is currently being phased out and is a Restricted Use Pesticide that can only be purchased and applied by certified applicators. Glyphosate is a broad-spectrum, non-selective systemic herbicide commonly formulated as Roundup. It tends to bound tightly with sediments, and is not very leachable by stormwater runoff. Its half life in pond water ranges from 12 days to 10 weeks (WRA, 2002).

Past and current agricultural practices consisted primarily of ranching, growing barley, and some nursery uses. In order to help identify the presence of legacy and other pesticides from these activities, Wildermuth analyzed stormwater runoff samples for organochlorine and organophosphate pesticides; the data has been provided in Appendix C. Six samples (one sample from six stations) for organochlorine pesticides were below detection. Detection values for most pesticides ranged between 0.1 to 0.6 µg/L. The detection limit for toxaphene was 1.3 µg/L, which is greater than the water quality criteria (0.73 µg/L). These data indicate that legacy pesticides are generally not present in stormwater runoff from the proposed development area; there is uncertainty, as in the case of toxaphene, as to whether the legacy pesticides are present at levels of concern due to the detection limit being greater than the water quality standard.

BMPs that will be implemented to address pesticides include non-structural and structural source control, low flow recycling, and treatment in the combined control system. EPA has recently banned the pesticides diazinon and chlorpyrifos (commonly used urban pesticides) for most urban applications (USEPA, 2002). These pesticides, as well as other banned pesticides, will

not be used for landscape maintenance. Other source control measures include education programs for owners, occupants, and employees in the proper application, storage, and disposal of pesticides.

Pesticide discharges are of particular concern in golf courses. An Integrated Pest Management Plan (IPM) will be developed and implemented for the proposed golf courses. This plan will be the same or equivalent to the IPM for the approved Arroyo Trabuco Golf Course. Pesticides will be stored at the golf courses in an enclosure such as a cabinet, shed, or similar structure or will be stored on a paved surface and under cover and protected by secondary containment structures such as berms, dikes, or curbs. Dry weather flows and storm flows from the golf course will be treated in the combined control facilities, stored in non-domestic water storage reservoirs, and recycled for irrigation.

While some increase in pesticide use is likely to occur as the result of development due to maintenance of landscaped areas, particularly in the residential and golf portions of the development, careful selection, storage and application of these chemicals will help prevent water quality impacts from occurring. With appropriate management and storage of pesticides, no adverse impacts are expected to occur with development. Based on this combined source control and treatment strategy, potential impacts of pesticides on water quality are considered to be less than significant.

### ***Impacts to Trash and Debris***

Urban development tends to generate significant amounts of trash and debris. Trash refers to any human-derived materials including paper, plastics, metals, glass and cloth. Debris includes organic material transported by stormwater, including leaves, twigs, and grass clippings. Trash and debris is often characterized as material retained on a 5-mm mesh screen. It contributes to the degradation of receiving waters by imposing an oxygen demand, attracting pests, disturbing physical habitats, clogging storm drains and conveyance culverts and mobilizing nutrients, pathogens, metals, and other pollutants that may be attached to the surface. Sources of trash in developed areas can be both accidental and intentional. During wet weather events, gross debris deposited on paved surfaces can be transported to storm drains, where it is eventually discharged to receiving waters. Trash and debris can also be mobilized by wind and transported directly into waterways.

Urbanization could significantly increase trash and debris loads if left unchecked. However, the proposed BMPs, including source control and treatment BMPs, will minimize the adverse impacts of trash and debris. Source controls such as street sweeping, public education, fines for littering, and storm drain stenciling can be effective in reducing the amount of trash and debris that is available for mobilization during wet and dry weather events. Water quality basins are very effective at trapping trash and debris. Trash and debris are not expected to significantly impact receiving waters due to the implementation of PDFs.

## ***Impacts to Chlorine***

Chlorine is a potential pollutant of concern because the free form of chlorine is a strong oxidant and is therefore very toxic to aquatic life. With respect to new development, one dry weather concern is the emptying of swimming pools that have not been de-chlorinated into local streams. Municipal pools and private pools in areas served by a municipal sanitary system are generally required to be discharged into the sanitary system. Under these conditions, the impact of new development on beneficial uses of local receiving waters from chlorine discharges is considered less than significant.

### **5.1.2 Groundwater Impacts**

Although geology and groundwater conditions vary depending on the terrain (Balance Hydrologics, 2001b), the impacts of the proposed development on groundwater quality are discussed in a general framework.

The approach taken by the WQMP to protect groundwater quality is multi-tiered: (1) site design and source control BMPs will be implemented to prevent the discharge of pollutants to the maximum extent practicable, (2) the proposed combined control system will incorporate infiltration only where there is at least a ten foot separation to groundwater, and (3) where infiltration is proposed, the water will be pretreated in a water quality treatment facility sized to meet MS4 Permit requirements.

Some incidental infiltration also will occur in the flow control/water quality basins upstream of the infiltration basins. However, in these basins, vegetation would be allowed to grow and decay, which will provide an adsorptive organic layer on the bottom of these basins that will assist in pollutants uptake and protect groundwater quality.

The only pollutant of concern for which there is a groundwater quality objective is nitrate. The water quality objective for nitrate-nitrogen is 10 mg/L; however, this level is much higher than observed concentrations of nitrate-nitrogen in urban runoff. For example, the range of observed nitrate-nitrogen concentrations from urban land uses in LA County are about 0.3 to 1.4 mg/L. Projected effluent concentrations from the FD/WQ basin would be about 0.3 mg/L. On this basis, the potential for adversely affecting groundwater quality for this pollutant of concern is considered less than significant.

### **5.1.3 Construction-Related Impacts**

The potential impacts of construction on water quality focus primarily on sediments and turbidity and pollutants that might be associated with sediments (e.g., phosphorus). Construction-related activities that are primarily responsible for sediment releases are related to exposing soils to potential mobilization by rainfall/runoff and wind. Such activities include removal of vegetation from the site, grading of the site, and trenching for infrastructure improvements. Environmental factors that affect erosion include topographic, soil, and rainfall characteristics.



Construction impacts will be minimized through the development and implementation of erosion and sediment control BMPs that will meet or exceed measures required by the State Water Quality Control Board's NPDES General Construction Permit. Erosion control BMPs are designed to prevent erosion, whereas sediment controls are designed to trap sediment once it has been mobilized. A Stormwater Pollution Prevention Plan (SWPPP) will be developed as required by, and in compliance with, the General Construction Permit. This permit requires BMP selection, implementation, and maintenance during the construction phase of development.

The significance criteria during the construction phase is implementation of Best Management Practices consistent with Best Available Technology Economically Achievable and Best Conventional Pollutant Control Technology (BAT/BCT), as required by the Construction General Permit and Section 8 of the DAMP. Erosion and sediment transport and transport of other potential pollutants during the construction phase will be reduced or prevented through implementation of BAT/BCT in order to prevent or minimize environmental impacts during the construction phase.

#### **5.1.4 Compliance with Plans, Policies, Regulations, and Permits**

A key significance criterion that is applicable to the proposed alternatives as a whole is compliance with plans, policies, regulations and permits (Chapter 2). The following section specifically addresses compliance with this significance criterion.

##### ***Compliance with Plans and Policies***

As discussed in Chapter 1, the Conceptual WQMP was developed to assess potential water quality, water balance, and hydromodification impacts of development that could occur within the development bubbles identified within the "B" Alternatives selected for review under the GPA/ZC, NCCP/HCP, and SAMP/MSAA and to recommend control measures to address those potential impacts. The WQMP was initially prepared to address the proposed GPA/ZC project "The Ranch Plan" (also known as Alternative B-4) in support of the GPA/ZC, as well as the NCCP/HCP and SAMP/MSAA. With the formulation of the B-9 alternative by the NCCP/SAMP Working Group an alternative designed to meet the NCCP Guidelines and Watershed Planning Principles, the Conceptual WQMP was expanded to include measures and analyses addressing Alternative B-9.

The WQMP elements were developed based on the general Local WQMP requirements and sub-basin specific water quality and hydrologic issues as identified in the *Draft Watershed and Sub-basin Planning Principles*. The selection and sizing of the facilities in the combined control systems for each sub-basin was guided by site conditions, the type of development land use, and incorporation of the planning recommendations also identified in the *Draft Watershed and Sub-basin Planning Principles*.

### ***Compliance with Local WQMP and MS4 Permit Requirements***

PDFs include site design, source control, and treatment control BMPs in compliance with the requirements of the Orange County Local WQMP and the Orange County NPDES Permit (Order No. R9-2002-0001). For most catchments, a combined control system consisting of a flow control/water quality basin, a separate infiltration basin, and a lined or unlined bioswale will be implemented. Recycling for irrigation and diversion of runoff to less sensitive areas are other strategies that are used depending on conditions. The site design, source control, and treatment control BMPs will work in concert to address all of the constituents of concern in runoff from the proposed development area.

The combined control system sizing meets or exceeds the NPDES Permit sizing requirement for treatment control BMPs. The FD/WQ lower basin volumes were sized according to meet sizing criteria option 2 for volume-based BMPs in the Local WQMP:

- *The volume of annual runoff produced by the 85th percentile, 24-hour rainfall event, determined as the maximized capture stormwater volume for the area, from the formula recommended in Urban Runoff Quality Management, WEF Manual of Practice No. 23/ASCE Manual of Practice No. 87 (1998),*

with a draw-down time of 48 hours, which is satisfactory for treatment while minimizing mosquito problems.

Where vegetated bioinfiltration swales are proposed as stand alone treatment control BMPs, they will be sized to meet the Local WQMP sizing criteria below:

- *The maximum flow rate of runoff produced by the 85th percentile hourly rainfall intensity, as determined from the local historical rainfall record, multiplied by a factor of two; or*
- *The maximum flow rate of runoff, as determined from the local historical rainfall record, which achieves approximately the same reduction in pollutant loads and flows as achieved by mitigation of the 85th percentile hourly rainfall intensity multiplied by a factor of two.*

## **5.2 IMPACT ANALYSIS FOR THE CAÑADA CHIQUITA SUB-BASIN**

This section evaluates the effectiveness of the WQMP for the Cañada Chiquita Sub-basin and evaluates the impacts of the proposed development on pollutants of concern and hydrologic conditions of concern. The impacts are evaluated first for the B-4 alternative, and then for the B-9 alternative.

## 5.2.1 Impacts on Hydrologic Conditions of Concern

### *Alternative B-4*

Impacts on hydrologic conditions of concern in Cañada Chiquita for the B-4 alternative were evaluated based on the comparison of the pre- and post-development water balance results at the sub-basin scale and comparisons of pre- and post-development flow duration at the development bubble scale. The post-development condition reflects the effects of the combined control system for catchments affected by development, and in the case of the water balance assessments, reflects the additional effects of irrigating urban landscaping and the golf course and effects of vegetation changes on evapotranspiration (ET).

#### *Hydrologic Condition of Concern #1: Increased Stormwater Runoff Flow Rate, Volume, and Flow Duration*

In order to address this hydrologic condition of concern, the effects of the proposed development on runoff flow rate, peak discharge, and flow duration were evaluated with two types of analyses: (1) flow duration analysis, and (2) water balance analysis. The flow duration analysis was conducted first. The flow duration analysis results were used to select and size the combined control system facilities. Finally, the water balance was conducted taking into account the hydrologic control achieved with these facilities.

The flow duration analysis was conducted at the “development bubble scale”, as this was the basis for sizing the facilities in the combined control system. Although the analysis was conducted for each catchment affected by development, the results for one example are provided here. The flow duration results for Chiquita Catchment 13 for the 53 year period of record are shown in Figure 5-1. This figure shows the cumulative distribution of the duration of flows for the three development scenarios: pre-development discharge to the stream, post-development discharge to the stream, and post-development discharge with controls. The figure also shows the post-development 2 and 10 year peak flows, which is considered the approximate range of channel adjusting flows and are required to be analyzed by the Local WQMP. As indicated in the figure, the proposed control facilities achieve good flow duration matching over the entire range of flows including the 2 and 10 year peak flows. These results indicate that matching pre-development flow duration was possible utilizing the combined control system in Catchment 13. The extent to which flow duration matching was achieved for each catchment varied depending on conditions in each catchment. Catchments where it was more difficult to achieve matching were balanced by “over matching” in neighboring catchments where conditions were more favorable for matching.

Before conducting the water balance assessments, the effects of irrigation were analyzed based on the irrigation projections used by the Santa Margarita Water District in their report titled *Plan of Works for Improvement Districts 4CX, 4E, 5 and 6*, which includes the RMV Project area. Appendix A provides a detailed description of how irrigation volumes were estimated by month, by climatic condition, and for different land uses.

The potential role of irrigation in the Chiquita Sub-basin is illustrated in Figure 5-2, which compares predicted irrigation volumes with historic precipitation volumes. Figure 5-2 shows that irrigation effects are most pronounced during the dry summer months. Considering all years, irrigation will add about 10 percent to the overall water balance for the sub-basin as a whole. Most, if not all, of this water will be infiltrated and/or evapotranspired in the combined control system.

The irrigation estimates were incorporated into the SWMM modeling and the SWMM model was adapted so that results for surface runoff, evapotranspiration, and groundwater outflow could be compiled in the form of “water balances”. These water balances, developed as described in Chapter 3, are shown for the Chiquita Sub-basin in Figure 5-3 and are tabulated in Tables 5-1, 5-2, and 5-3 (and Appendix D) for the following three climatic conditions:

- All Years in the Available Rainfall Record (WYs 1949 - 2001),
- Dry Years (WYs 1947 - 1977 and 1984 - 1990), and
- Wet Years (WYs 1978 - 1983 and 1991 - 2001).

In each table the results are shown for two development scenarios: existing conditions and post-development conditions with the PDFs. For each scenario, the table shows the “inflows” or “deposits” to the balance, which consist of precipitation for the pre-development condition and precipitation plus irrigation for the post-developed condition. “Outflows” or “withdrawals” consist of surface runoff to the main stem channel or diversion outside the sub-basin, infiltration that results in groundwater outflow to streams, and evapotranspiration. The unit of measure in the water balance is inches and in parentheses, acre-ft, where the inches are the volume in acre-ft divided by the sub-basin area. In semi-arid areas the water balance also varies by season and the table shows the variability in the monthly water balance.

Lastly the rainfall analysis conducted for each sub-basin takes into account the effect of elevation on rainfall and, because of grading, this can introduce small changes in the precipitation between the pre- and post-development condition. Also the modeling itself can introduce small water balance errors; e.g., there can be a small change between the assumed initial groundwater storage at the start of the simulation and the final storage at the end of the simulation. These effects can result in very small, but perceptible changes between the inflow and outflow totals (e.g., for precipitation), but are not meaningful in terms of the overall water balance.

The “inflow” conditions for each table indicate that the mean annual rainfall on the Chiquita Sub-basin varies from about 14 inches per year during dry years to about 22 inches per year during wet years, or about 16 inches per year for all years considered. The projected effect of irrigation is to add about 1.6 inches per year (available irrigation projections did not address effects of climate cycles on irrigation rates) or about 7 to 11 percent depending on the climatic conditions.

The predicted effects of the proposed alternatives on sub-basin hydrology can be examined by comparing the mean annual values of runoff and groundwater outflow for the post-development with PDFs condition with the pre-development condition. For all years, which was the period used for sizing the control facilities, the surface runoff to Chiquita Creek is predicted to increase approximately 20 percent. These changes, in absolute terms, are less than changes associated with the natural variability in runoff. For example, the predicted effect of the proposed development on runoff volumes is to increase the mean runoff to Chiquita Creek to 135 acre-ft/yr from 112 acre-ft/yr, or a 20 percent change. However the predicted mean annual runoff prior to development during wet years is 201 acre-ft/yr or approximately an 80 percent change.

The water balance tables also show projected values for surface runoff discharged directly to San Juan Creek. These discharges, as described earlier, originate from Catchments 16, 17 and 18. Catchment 18 naturally drains to San Juan Creek. In the case of catchments 16 and 17, excess flows, defined as the difference between projected flows under post-development and projected existing flows, were re-directed to San Juan Creek. Surface runoff from direct discharges to San Juan Creek is predicted to increase from about 1 acre-foot per year in all years in the pre-developed condition to 95 acre-feet per year in the post-developed condition (Table 5-1). The relatively small runoff of 1 acre-foot per year is because only Catchment 18 is presently discharging directly to San Juan Creek, and that catchment has highly infiltrative soils that limit surface runoff.

**Table 5-1: Alternative B-4 Chiquita Sub-basin Water Balance, All Years (inches (acre-ft))**

	Pre-Development <sup>1</sup>						Post-Development with PDFs <sup>2</sup>							
	INFLOW	OUTFLOW					INFLOW			OUTFLOW				
	Precipitation	Runoff to Chiquita	Runoff to San Juan Creek	GW Outflow	ET	Total	Precipitation	Irrigation	Total	Runoff to Chiquita	Runoff to San Juan Creek	GW Outflow	ET	Total
<b>OCT</b>	0.3 (116)	0.0 (1)	0.0 (0)	0.1 (40)	0.3 (122)	0.5 (163)	0.3 (114)	0.1 (37)	0.4 (151)	0.0 (1)	0.0 (2)	0.1 (47)	0.4 (155)	0.6 (205)
<b>NOV</b>	1.7 (602)	0.0 (7)	0.0 (0)	0.1 (33)	0.7 (235)	0.8 (275)	1.7 (592)	0.0 (16)	1.7 (608)	0.0 (9)	0.0 (10)	0.1 (52)	0.7 (239)	0.9 (310)
<b>DEC</b>	2.3 (794)	0.0 (10)	0.0 (0)	0.1 (41)	0.8 (274)	0.9 (325)	2.2 (781)	0.0 (11)	2.3 (793)	0.0 (13)	0.0 (13)	0.2 (72)	0.8 (266)	1.0 (364)
<b>JAN</b>	3.8 (1336)	0.1 (25)	0.0 (0)	0.4 (131)	0.9 (325)	1.4 (481)	3.8 (1314)	0.0 (10)	3.8 (1324)	0.1 (32)	0.1 (22)	0.5 (180)	0.9 (310)	1.6 (544)
<b>FEB</b>	3.5 (1234)	0.1 (46)	0.0 (1)	0.8 (277)	1.2 (422)	2.1 (747)	3.5 (1214)	0.0 (8)	3.5 (1222)	0.1 (52)	0.1 (20)	0.9 (314)	1.1 (399)	2.2 (784)
<b>MAR</b>	2.9 (1025)	0.0 (14)	0.0 (0)	1.1 (396)	1.8 (625)	3.0 (1035)	2.9 (1008)	0.1 (31)	3.0 (1039)	0.1 (19)	0.0 (17)	1.2 (423)	1.7 (590)	3.0 (1049)
<b>APR</b>	1.2 (417)	0.0 (5)	0.0 (0)	0.7 (242)	2.2 (784)	2.9 (1030)	1.2 (410)	0.2 (59)	1.3 (469)	0.0 (5)	0.0 (6)	0.7 (257)	2.1 (744)	2.9 (1013)
<b>MAY</b>	0.4 (138)	0.0 (1)	0.0 (0)	0.4 (145)	2.2 (771)	2.6 (917)	0.4 (136)	0.2 (75)	0.6 (212)	0.0 (1)	0.0 (2)	0.4 (154)	2.2 (754)	2.6 (912)
<b>JUN</b>	0.1 (49)	0.0 (0)	0.0 (0)	0.3 (96)	1.2 (416)	1.5 (512)	0.1 (48)	0.3 (89)	0.4 (138)	0.0 (0)	0.0 (1)	0.3 (103)	1.3 (464)	1.6 (568)
<b>JUL</b>	0.0 (11)	0.0 (0)	0.0 (0)	0.2 (75)	0.2 (55)	0.4 (130)	0.0 (11)	0.3 (91)	0.3 (102)	0.0 (0)	0.0 (0)	0.2 (82)	0.4 (140)	0.6 (222)
<b>AUG</b>	0.1 (40)	0.0 (0)	0.0 (0)	0.2 (59)	0.1 (40)	0.3 (99)	0.1 (39)	0.2 (84)	0.4 (123)	0.0 (0)	0.0 (1)	0.2 (66)	0.3 (118)	0.5 (186)
<b>SEP</b>	0.4 (123)	0.0 (1)	0.0 (0)	0.1 (46)	0.3 (92)	0.4 (140)	0.3 (121)	0.2 (60)	0.5 (181)	0.0 (2)	0.0 (2)	0.2 (55)	0.4 (147)	0.6 (205)
<b>Total</b>	<b>16.8 (5886)</b>	<b>0.3 (112)</b>	<b>0.0 (1)</b>	<b>4.5 (1581)</b>	<b>11.9 (4160)</b>	<b>16.7 (5854)</b>	<b>16.5 (5790)</b>	<b>1.6 (571)</b>	<b>18.2 (6360)</b>	<b>0.4 (135)</b>	<b>0.3 (95)</b>	<b>5.2 (1806)</b>	<b>12.3 (4326)</b>	<b>18.2 (6362)</b>

<sup>1</sup>Pre-development sub-basin area = 4200 acres. Volumes given are inches over the sub-basin area.

<sup>2</sup>Post-development sub-basin area = 4204 acres. Volumes given are inches over the sub-basin area.

**Table 5-2: Alternative B-4 Chiquita Sub-basin Water Balance, Dry Years (inches (acre-ft))**

	Pre-Development <sup>1</sup>						Post-Development with PDFs <sup>2</sup>							
	INFLOW	OUTFLOW					INFLOW			OUTFLOW				
	Precipitation	Runoff to Chiquita	Runoff to San Juan Creek	GW Outflow	ET	Total	Precipitation	Irrigation	Total	Runoff to Chiquita	Runoff to San Juan Creek	GW Outflow	ET	Total
<b>OCT</b>	0.3 (116)	0.0 (1)	0.0 (0)	0.1 (30)	0.4 (140)	0.5 (171)	0.3 (114)	0.1 (36)	0.4 (151)	0.0 (1)	0.0 (2)	0.1 (38)	0.5 (170)	0.6 (211)
<b>NOV</b>	1.9 (651)	0.0 (8)	0.0 (0)	0.1 (25)	0.7 (250)	0.8 (283)	1.8 (640)	0.0 (16)	1.9 (656)	0.0 (10)	0.0 (11)	0.1 (47)	0.7 (253)	0.9 (320)
<b>DEC</b>	2.4 (843)	0.0 (11)	0.0 (0)	0.1 (35)	0.8 (288)	1.0 (333)	2.4 (830)	0.0 (11)	2.4 (841)	0.0 (14)	0.0 (14)	0.2 (68)	0.8 (277)	1.1 (373)
<b>JAN</b>	2.8 (997)	0.0 (13)	0.0 (0)	0.2 (56)	0.9 (326)	1.1 (395)	2.8 (981)	0.0 (10)	2.8 (991)	0.0 (17)	0.0 (16)	0.3 (97)	0.9 (311)	1.3 (441)
<b>FEB</b>	2.5 (867)	0.1 (22)	0.0 (0)	0.3 (106)	1.2 (420)	1.6 (548)	2.4 (853)	0.0 (8)	2.5 (861)	0.1 (25)	0.0 (14)	0.4 (140)	1.1 (396)	1.6 (575)
<b>MAR</b>	2.0 (685)	0.0 (8)	0.0 (0)	0.5 (169)	1.8 (617)	2.3 (794)	1.9 (673)	0.1 (31)	2.0 (704)	0.0 (9)	0.0 (11)	0.6 (194)	1.7 (584)	2.3 (798)
<b>APR</b>	1.2 (433)	0.0 (5)	0.0 (0)	0.4 (133)	2.2 (772)	2.6 (909)	1.2 (426)	0.2 (58)	1.4 (484)	0.0 (5)	0.0 (7)	0.4 (150)	2.1 (736)	2.6 (898)
<b>MAY</b>	0.4 (137)	0.0 (1)	0.0 (0)	0.2 (81)	2.1 (732)	2.3 (815)	0.4 (135)	0.2 (74)	0.6 (209)	0.0 (1)	0.0 (2)	0.3 (92)	2.1 (725)	2.3 (820)
<b>JUN</b>	0.1 (35)	0.0 (0)	0.0 (0)	0.2 (57)	1.1 (371)	1.2 (428)	0.1 (35)	0.3 (88)	0.4 (123)	0.0 (0)	0.0 (0)	0.2 (65)	1.2 (428)	1.4 (494)
<b>JUL</b>	0.0 (15)	0.0 (0)	0.0 (0)	0.1 (46)	0.1 (49)	0.3 (95)	0.0 (15)	0.3 (90)	0.3 (104)	0.0 (0)	0.0 (0)	0.2 (54)	0.4 (134)	0.5 (189)
<b>AUG</b>	0.1 (45)	0.0 (0)	0.0 (0)	0.1 (37)	0.1 (42)	0.2 (79)	0.1 (44)	0.2 (83)	0.4 (127)	0.0 (1)	0.0 (1)	0.1 (46)	0.3 (118)	0.5 (165)
<b>SEP</b>	0.3 (117)	0.0 (1)	0.0 (0)	0.1 (30)	0.3 (92)	0.4 (124)	0.3 (115)	0.2 (60)	0.5 (175)	0.0 (1)	0.0 (2)	0.1 (40)	0.4 (145)	0.5 (189)
<b>Total</b>	<b>14.1 (4941)</b>	<b>0.2 (70)</b>	<b>0.0 (0)</b>	<b>2.3 (805)</b>	<b>11.7 (4099)</b>	<b>14.2 (4974)</b>	<b>13.9 (4860)</b>	<b>1.6 (565)</b>	<b>15.5 (5426)</b>	<b>0.2 (84)</b>	<b>0.2 (79)</b>	<b>2.9 (1031)</b>	<b>12.2 (4279)</b>	<b>15.6 (5473)</b>

<sup>1</sup>Pre-development sub-basin area = 4200 acres. Volumes given are inches over the sub-basin area.

<sup>2</sup>Post-development sub-basin area = 4204 acres. Volumes given are inches over the sub-basin area.

**Table 5-3: Alternative B-4 Chiquita Sub-basin Water Balance, Wet Years (inches (acre-ft))**

	Pre-Development <sup>1</sup>						Post-Development with PDFs <sup>2</sup>							
	INFLOW	OUTFLOW					INFLOW			OUTFLOW				
	Precipitation	Runoff to Chiquita	Runoff to San Juan Creek	GW Outflow	ET	Total	Precipitation	Irrigation	Total	Runoff to Chiquita	Runoff to San Juan Creek	GW Outflow	ET	Total
<b>OCT</b>	0.3 (115)	0.0 (1)	0.0 (0)	0.2 (61)	0.2 (83)	0.4 (145)	0.3 (113)	0.1 (37)	0.4 (150)	0.0 (1)	0.0 (2)	0.2 (67)	0.3 (122)	0.5 (192)
<b>NOV</b>	1.4 (498)	0.0 (6)	0.0 (0)	0.1 (49)	0.6 (202)	0.7 (257)	1.4 (490)	0.0 (16)	1.4 (506)	0.0 (8)	0.0 (8)	0.2 (64)	0.6 (210)	0.8 (289)
<b>DEC</b>	2.0 (691)	0.0 (8)	0.0 (0)	0.2 (53)	0.7 (246)	0.9 (308)	1.9 (679)	0.0 (11)	2.0 (691)	0.0 (11)	0.0 (12)	0.2 (82)	0.7 (241)	1.0 (345)
<b>JAN</b>	5.9 (2054)	0.1 (51)	0.0 (0)	0.8 (290)	0.9 (321)	1.9 (663)	5.8 (2020)	0.0 (10)	5.8 (2030)	0.2 (64)	0.1 (33)	1.0 (355)	0.9 (309)	2.2 (761)
<b>FEB</b>	5.7 (2012)	0.3 (98)	0.0 (3)	1.8 (642)	1.2 (426)	3.3 (1169)	5.6 (1979)	0.0 (8)	5.7 (1987)	0.3 (110)	0.1 (32)	1.9 (682)	1.2 (404)	3.5 (1228)
<b>MAR</b>	5.0 (1745)	0.1 (28)	0.0 (0)	2.5 (878)	1.8 (640)	4.4 (1546)	4.9 (1717)	0.1 (30)	5.0 (1747)	0.1 (41)	0.1 (29)	2.6 (907)	1.7 (605)	4.5 (1582)
<b>APR</b>	1.1 (382)	0.0 (4)	0.0 (0)	1.3 (472)	2.3 (810)	3.7 (1287)	1.1 (376)	0.2 (60)	1.2 (436)	0.0 (5)	0.0 (6)	1.4 (484)	2.2 (761)	3.6 (1256)
<b>MAY</b>	0.4 (141)	0.0 (2)	0.0 (0)	0.8 (280)	2.4 (854)	3.2 (1135)	0.4 (139)	0.2 (76)	0.6 (215)	0.0 (2)	0.0 (2)	0.8 (287)	2.3 (815)	3.2 (1106)
<b>JUN</b>	0.2 (78)	0.0 (1)	0.0 (0)	0.5 (178)	1.5 (510)	2.0 (689)	0.2 (77)	0.3 (89)	0.5 (166)	0.0 (1)	0.0 (1)	0.5 (183)	1.5 (539)	2.1 (724)
<b>JUL</b>	0.0 (4)	0.0 (0)	0.0 (0)	0.4 (135)	0.2 (67)	0.6 (202)	0.0 (4)	0.3 (91)	0.3 (95)	0.0 (0)	0.0 (0)	0.4 (140)	0.4 (151)	0.8 (291)
<b>AUG</b>	0.1 (29)	0.0 (0)	0.0 (0)	0.3 (104)	0.1 (36)	0.4 (140)	0.1 (29)	0.2 (84)	0.3 (113)	0.0 (0)	0.0 (0)	0.3 (109)	0.3 (118)	0.7 (228)
<b>SEP</b>	0.4 (136)	0.0 (2)	0.0 (0)	0.2 (81)	0.3 (94)	0.5 (176)	0.4 (134)	0.2 (60)	0.6 (194)	0.0 (2)	0.0 (2)	0.3 (88)	0.4 (149)	0.7 (240)
<b>Total</b>	<b>22.5 (7887)</b>	<b>0.6 (201)</b>	<b>0.0 (3)</b>	<b>9.2 (3223)</b>	<b>12.3 (4289)</b>	<b>22.0 (7716)</b>	<b>22.1 (7758)</b>	<b>1.6 (572)</b>	<b>23.8 (8330)</b>	<b>0.7 (244)</b>	<b>0.4 (127)</b>	<b>9.8 (3447)</b>	<b>12.6 (4425)</b>	<b>23.5 (8244)</b>

<sup>1</sup>Pre-development sub-basin area = 4200 acres. Volumes given are inches over the sub-basin area.

<sup>2</sup>Post-development sub-basin area = 4204 acres. Volumes given are inches over the sub-basin area.



The central portion of the main stem of San Juan Creek, downstream of Bell, Lucas, and Verdugo Canyons, consists of a meandering river with several floodplain terraces in a wide valley bottom (PCR et al, 2002). In this reach, San Juan Creek serves as a sediment transport conduit between the major sediment-producing sub-basins and downstream areas. The result is that the channel is made up of fairly coarse substrate including cobbles that is mobilized only under large events. The effect of the projected additional 95 acre-ft of runoff on San Juan Creek fall into three categories: the effect on channel stability, the effect on vegetation and habitat, and the effect on water supply. With respect to channel stability, the additional runoff volume will not result in increasing peak flows capable of mobilizing sediments, in part because the increase in peak flows from the development area will be small compared with peak flows in San Juan Creek, and in part because the peak flows from the development area have been shown to precede peak flows from the larger watershed (PCR et al, 2002). With respect to effects on habitat, much of the additional volume or runoff occurs in January through June, which corresponds to the arroyo toad breeding season, thereby providing water when it is a significant limiting factor to successful recruitment. With respect to water supply, much of the additional runoff volume will ultimately infiltrate into the wide San Juan channel and will help to sustain the groundwater aquifer for downstream water supply users.

#### *Hydrologic Condition of Concern #2: Decreased Infiltration and Groundwater Recharge*

Given the reliance on infiltration in the combined control system, changes to groundwater infiltration and outflow are more pronounced. Annual groundwater infiltration is predicted to increase from about 1,581 acre-ft under existing conditions to 1,806 acre-ft under the developed condition, for an increase of approximately 200 acre-ft/yr.

So with respect to this hydrologic condition of concern, the effect of the development is likely to increase infiltration and groundwater recharge; it is very unlikely that infiltration and groundwater recharge would be reduced.

#### *Hydrologic Condition of Concern #3: Changed Base Flows*

The increase in infiltration and groundwater outflow leads to increases in base flows of approximately 200 acre-ft/yr. This additional water could be carried down Chiquita Creek to San Juan Creek, infiltrate in the stream channel, or enhance existing or support additional riparian vegetation. There is evidence that the quality of the existing riparian vegetation in lower Chiquita could benefit from additional water. The Restoration Ecologist, in consultation with the Reserve Owner/Manager, will assess the opportunities for enhancement of existing riparian vegetation and creation of new riparian/wetland vegetation that would yield the maximum benefit from the additional water.

The potential benefits of increased base flows obviously depend on a number of factors, including groundwater transport processes in the alluvial aquifer. Such processes will affect where base flow increases may occur and the magnitude of those increases. The proposed approach would be to adopt an adaptive management strategy that would try to take advantage of

the additional anticipated water. If increased groundwater infiltration and increased base flows is determined to be beneficial to riparian habitats, no changes would be made to flow management. If it is determined that increased base flows are causing negative environmental effects, such as facilitating the invasion of exotic plant and wildlife species (e.g., bullfrogs), modifications in the flow management system to control these adverse effects will be evaluated and implemented. Such modifications could include additional routing of surface flows out of the sub-basin to San Juan Creek, or additional utilization of surface runoff for non-domestic water supply to decrease or offset increases in groundwater infiltration. A long-term adaptive management program is presented in Chapter 6.

### ***Alternative B-9***

Impacts on hydrologic conditions of concern in Cañada Chiquita for the B-9 alternative were analyzed as follows. Where the proposed development under the B-9 alternative was similar to that in the B-4 alternative, impacts were assessed qualitatively based on the modeling results conducted for the B-4 alternative. Where the proposed development under the B-9 alternative was substantially different from the B-4 alternative, a qualitative analysis was conducted based on our understanding of the sub-basin conditions and literature information on the effects of urbanization on hydrology and water quality.

Figure 1-4 shows the proposed development areas under the B-9 alternative, which can be compared with the corresponding development areas under the B-4 alternative as shown in Figure 1-3. Table 4-5 lists the proposed land uses in the Chiquita Sub-basin under each alternative. As indicated in the table and figures, the proposed development under the B-9 alternative would be smaller (309 acres versus 339 acres for the B-4 alternative), and would be located in the lower eastern portion of the sub-basin. Also, under the B-9 alternative there would not be a golf course or associated golf course residences, nor is development proposed in Middle Chiquita near the Tesoro High School.

Under the B-9 alternative, there would be no impacts in the middle portion of the sub-basin. Impacts on hydrologic conditions of concern for the proposed development in the lower portion of Chiquita Canyon would be similar to impacts identified for this area under the B-4 alternative. Effective management of increased channel forming flows has been shown to be feasible using a combined flow duration and water quality treatment basin whose outlet structure is designed to mimic the pre-development runoff flow duration. Excess flows would be infiltrated, thereby increasing recharge and base flows. Increased base flows could be beneficial to existing habitat and possibly for increased riparian habitat. If groundwater levels were to increase to the extent that infiltration was not feasible, other options could include direct diversion of excess flows to San Juan Creek, diversion to the nearby WWTP for reclamation, or diversion to a non-domestic water supply reservoir.

## **5.2.2 Impacts on Pollutants of Concern – Alternative B-4**

The section presents the water quality modeling results used to address impacts of stormwater runoff on sediments, nutrients, and trace metals. The modeling approach has been described in Chapter 3, and more technical details can be found in Appendix B. The modeling results are in the form of mean annual loads and mean annual concentrations. Concentration is defined as the mass of pollutant contained in a unit volume of water in the runoff. A common measure of concentration in stormwater is the Event Mean Concentration (EMC), which is the average concentration during a runoff event. Load is the mass of pollutant associated with an event or series of events. The mean annual load is the mass of a given pollutant that on average is discharged annually. It is estimated in the water quality model as the average of the predicted annual loads over the 53 year simulation period. The mean annual concentration is the mean annual load divided by the mean annual runoff volume.

Results are provided for the three development scenarios: pre-development, post-development, and post-development with PDFs; for three climatic conditions: all years in the 53 year rainfall record, dry years, and wet years; and for discharges to Chiquita Creek and to San Juan Creek. The mean annual loads and mean annual concentrations reflect the entire portion of the sub-basin that discharges to each creek, including the catchments that drains to the combined control system (the area within the development) and untreated areas (the open space outside of the development). The numbers in the tables in this and all subsequent sections have been rounded-off. The percent change values in the tables are based on the unrounded results.

### ***TSS Loads and Concentrations***

Figure 5-4 shows the mean annual loads and concentrations for TSS for each development scenario, climatic period, and receiving water. Mean annual loads are highest during the wet years and lowest during dry years. Loads also increase with development due to increased runoff volume and decrease when controls are taken into account. Concentrations vary depending on the relative contribution of open space areas, which have higher TSS, compared to urbanized areas where runoff tends to have lower TSS concentrations. The contribution of fine sediment will be reduced by ridge development on clay soils. It is important to note however that open space areas in the sandy terrain of the canyon are also likely to be important sources of coarse sediment supply that will be preserved.

Table 5-4 summarizes TSS loads and concentrations and shows the percent change associated with the proposed development. During wet years, the predicted mean annual TSS load to Chiquita Creek, post development with PDFs, is estimated to be about 43 tons, which is a decrease of about 16 percent over pre-development conditions (51 tons). During dry years, the mean annual load is predicted to be 13 tons, which is about 12 percent less than the pre-development condition. Again, the changes associated with climatic conditions are larger than the changes associated with the proposed development.

The TSS loads to San Juan Creek from Chiquita Catchments 16, 17, and 18 are predicted to increase substantially relative to the pre-development condition because the loads under the pre-development condition are quite low. The net effect of development on TSS loads and concentrations is given in the bottom four rows of Table 5-4 and indicate a reduction in concentration of 42 to 47 percent, and no net change in TSS loads overall (all years).

Table 5-5 shows the predicted mean annual TSS concentration compared to water quality criteria and observed in-stream TSS concentrations. The criterion for TSS in the San Diego Basin Plan is narrative and states that “levels shall not cause a nuisance or adversely affect beneficial uses as a result of controllable water quality factors”. The combined control system is designed to treat by detention and infiltration 80 to 90 percent of the runoff and would address urban particulates containing other pollutants. The predicted TSS concentration of 93 mg/L is in the lower end of the range of observed data (ND – 3100 mg/L) reported by Wildermuth (the majority of TSS measurements are in the high end of the range). Thus discharges to the stream are projected to have lower TSS concentrations than the stream.

**Table 5-4: Predicted Average Annual TSS Loads and Concentrations for the Chiquita Sub-basin (Alternative B-4)**

Modeled Area	Site Condition	TSS Load (metric tons)			TSS Concentration (mg/L)		
		All Years	Dry Years	Wet Years	All Years	Dry Years	Wet Years
Chiquita Creek	Pre-Developed	26	14	51	168	150	181
	Developed	46	31	76	116	106	127
	Dev w/ PDFs	22	13	43	134	122	142
	Percent Change	-15	-12	-16	-20	-18	-21
San Juan Creek	Pre-Developed	0.3	0.1	0.8	224	224	224
	Developed	4	3	6	81	80	82
	Dev w/ PDFs	4	3	6	35	35	36
	Percent Change	1217	3866	615	-84	-84	-84
Total Sub-basin Area	Pre-Developed	26	14	52	168	150	182
	Developed	50	35	82	112	103	122
	Dev w/ PDFs	26	16	48	93	80	106
	Percent Change	0	11	-6	-45	-47	-42

**Table 5-5: Comparison of Predicted TSS Concentration with Water Quality Objectives and Observed In-Stream Concentrations for the Chiquita Sub-basin (Alternative B-4)**

Predicted Average Annual TSS Concentration <sup>1</sup> (mg/L)	San Diego Basin Plan Water Quality Objectives	Range of Observed In-Stream Concentrations <sup>2</sup> (mg/L)
93	TSS levels shall not cause a nuisance or adversely affect beneficial uses as a result of controllable water quality factors	None Detected – 3,100

<sup>1</sup>Modeled concentration for total project area developed conditions with PDFs in wet years.

<sup>2</sup>Range of concentrations observed at four San Juan watershed stations during storm events

NA – not applicable

### ***Nutrient Loads and Concentrations***

Figures 5-5, 5-6 and 5-7 show the mean annual loads and concentrations for nitrate-nitrogen, Total Kjeldahl Nitrogen (TKN), and total phosphorous. TKN is a measure of the total organic nitrogen and ammonia-nitrogen, which is an inorganic form of nitrogen. Nitrate-nitrogen and ammonia-nitrogen are bio-available forms of nitrogen that can cause excessive algal growth in streams. Elevated ammonia is usually associated with wastewater and moreover, the nitrogen cycle in most aerobic streams tends to convert the nitrogen in ammonia to the nitrate form. Therefore nitrate-nitrogen tends to be the more important nitrogen nutrient form with regards to stimulating algal growth.

Table 5-6 summarizes the nutrient loads and shows percent changes for all years, dry years, and wet years for all three nutrients and for discharges into Chiquita Creek and for direct discharges into San Juan Creek. Predicted nitrate loads to Chiquita Creek for development with controls range from 170 lbs/yr during dry years to 562 lbs/yr during wet years, while mean annual TKN loads are projected to be about 394 lbs/yr during dry years and 1,080 lbs/yr during wet years. The nitrate load is predicted to be 3 percent less than pre-development loads during wet years, while the TKN load prediction increases by 42 percent. The nitrate and TKN loads are about 4 percent and 32 percent higher than pre-development conditions, respectively, during dry years.

Table 5-7 summarizes the nutrient concentrations and shows percent changes for all years, dry years, and wet years for all three nutrients and for discharges into Chiquita Creek and for direct discharges into San Juan Creek. Mean annual concentrations of nitrate-nitrogen in discharges to Chiquita Creek from development with PDFs are predicted to be about 0.8 mg/L for all climatic conditions, which reflects a decrease in nitrate-nitrogen concentration ranging from 3 to 10 percent. These predicted concentrations of nitrate-nitrogen are within the range of 0.6 - 1.2 mg/L range reported by Wildermuth (Table 5-8). Mean annual concentrations of TKN are predicted to increase to about 1.6 mg/L. In comparison, Wildermuth found in-stream TKN to range from none-detected to 2.8 mg/L.

Total phosphorus loads are predicted to increase with development, but the addition of PDFs reduces the increase in loads such that during the wet years the predicted loads to Chiquita Creek in the developed condition with PDFs is 166 lbs/yr, which is about a 43 percent increase over pre-development loads. During dry years the mean annual load is predicted to be about 63 lbs/yr, which is about 27 percent higher than pre-development conditions.

These predicted increases for phosphorous may be inflated because the existing runoff of total phosphorus, used as the baseline assumption for modeling purposes, is based on 0.27 mg/L derived from the vacant land use station in the LA County database. Projections of phosphorous loads for vacant land use are affected significantly by local geology. Although no directly comparable local runoff data are available for the alternatives area, in-stream data collected by Wildermuth indicates that the Los Angeles runoff data may be low. Also geologic information cited in Appendix B of the Baseline Water Quality Conditions report indicates that approximately 8 percent of the sub-basin is underlain by Monterey Shale bedrock and therefore “nitrogen and phosphorous loadings from this sub-basin are likely quite high” (Balance Hydrologics, 2001a). This evidence suggests that model predictions of the pre-development loads, especially phosphorous, may be underestimated, which would lead to an overestimate of changes associated with the proposed development.

The water quality concern with nutrients is excessive algal growth. The Basin Plan narrative objective is “Concentrations of nitrogen and phosphorous, by themselves or in combination with other nutrients, shall be maintained at levels below those which stimulate algae and emergent plant growth.” Given the geological sources of phosphorous, it would appear that nitrogen nutrients are the more limiting nutrients (PCR et al, 2002). Moreover, as discussed earlier, nitrate-nitrogen is the more important nitrogen form with regard to stimulating algal growth. Table 5-7 indicate that nitrate-nitrogen concentrations are projected to decrease with development, and the results in Table 5-8 indicate that the projected nitrate-nitrogen concentrations are within the range of observed in-stream concentrations.

The combined control system, which incorporates wetlands, infiltration basins, and vegetated swales is specifically designed to treat nutrients. With respect to treatment effectiveness, constructed wetlands have been shown to be quite effective in reducing nitrates. Noteworthy examples in the region include Irvine Ranch Water District’s San Joaquin Marsh, used to treat water in San Diego Creek upstream of Newport Bay; and the Prado Wetlands which treat nutrients in reclaimed water entering Prado Reservoir and prior to being recharged in the downstream Santa Ana River recharge basins. Constructed wetlands and infiltration basins would be utilized as part of the combined control treatment system to treat low flows and small storm flows thereby reducing nutrient discharges to receiving streams.

Based on the model projections and the choice of nutrient treating elements in the combined control system, the potential for discharges from the proposed project to stimulate algal growth in Chiquita Creek or San Juan Creek is limited.

**Table 5-6: Predicted Average Annual Nutrient Loads for the Chiquita Sub-basin (Alternative B-4) (lbs)**

Modeled Area	Site Condition	Nitrate-N Load			TKN Load			Total Phosphorus Load		
		All Years	Dry Years	Wet Years	All Years	Dry Years	Wet Years	All Years	Dry Years	Wet Years
Chiquita Creek	Pre-Developed	298	164	582	447	299	759	71	50	116
	Developed	688	493	1102	1647	1283	2417	255	200	370
	Dev w/ PDFs	296	170	562	614	394	1080	96	63	166
	Percent Change	-1	4	-3	37	32	42	35	27	43
San Juan Creek	Pre-Developed	4	0.98	9.13	3	0.82	7.67	0	0.10	0.97
	Developed	67	54	93	242	199	332	41	34	56
	Dev w/ PDFs	78	65	107	412	343	558	69	57	94
	Percent Change	2076	6492	1073	13535	41543	7173	17917	54917	9513
Total Sub-basin Area	Pre-Developed	302	165	591	450	300	767	72	50	117
	Developed	755	547	1195	1889	1482	2749	296	234	426
	Dev w/ PDFs	374	235	669	1025	736	1637	165	121	260
	Percent Change	24	43	13	128	145	113	131	142	121

**Table 5-7: Predicted Average Annual Nutrient Concentrations the Chiquita Sub-basin (Alternative B-4) (mg/L)**

Modeled Area	Site Condition	Nitrate-N Concentration			TKN Concentration			Total Phosphorus Concentration		
		All Years	Dry Years	Wet Years	All Years	Dry Years	Wet Years	All Years	Dry Years	Wet Years
Chiquita Creek	Pre-Developed	0.87	0.77	0.94	1.3	1.4	1.2	0.21	0.24	0.19
	Developed	0.79	0.76	0.83	1.9	2.0	1.8	0.29	0.31	0.28
	Dev w/ PDFs	0.80	0.75	0.85	1.7	1.7	1.6	0.26	0.28	0.25
	Percent Change	-7	-3	-10	28	22	33	26	18	33

Modeled Area	Site Condition	Nitrate-N Concentration			TKN Concentration			Total Phosphorus Concentration		
		All Years	Dry Years	Wet Years	All Years	Dry Years	Wet Years	All Years	Dry Years	Wet Years
San Juan Creek	Pre-Developed	1.2	1.2	1.2	1.0	1.0	1.0	0.1	0.1	0.1
	Developed	0.6	0.6	0.6	2.1	2.1	2.1	0.4	0.4	0.3
	Dev w/ PDFs	0.3	0.3	0.3	1.6	1.6	1.6	0.3	0.3	0.3
	Percent Change	-74	-74	-73	64	63	64	116	115	117
Total Sub-basin Area	Pre-Developed	0.87	0.77	0.9	1.3	1.4	1.2	0.21	0.23	0.19
	Developed	0.77	0.74	0.8	1.9	2.0	1.8	0.30	0.31	0.29
	Dev w/ PDFs	0.60	0.53	0.7	1.6	1.7	1.6	0.26	0.27	0.26
	Percent Change	-31	-32	-30	26	17.9	32.6	28	16.02	37.51

**Table 5-8: Comparison of Predicted Nutrient Concentrations with Observed In-Stream Concentrations the Chiquita Sub-basin (Alternative B-4)**

Nutrient	Predicted Average Annual Concentration <sup>1</sup> (mg/L)			Observed Range of In-Stream Concentrations <sup>2</sup> (mg/L)
	All Years	Dry Years	Wet Years	
Nitrate-nitrogen	0.60	0.53	0.7	0.15 – 1.5
TKN	1.6	1.7	1.6	None Detected – 3.0
Total Phosphorus	0.26	0.27	0.26	None Detected – 2.8

<sup>1</sup>Modeled concentration for total project developed conditions with PDFs.

<sup>2</sup>Range of means observed at four San Juan watershed stations during the wet years.

### **Trace Metals**

Figures 5-8, 5-9, 5-10, 5-11, and 5-12 and Tables 5-9 and 5-10 show the predicted mean annual loads and mean annual concentrations for aluminum, cadmium, copper, lead, and zinc for the three development scenarios and for the three climatic conditions. Except for aluminum, the concentrations are all in the dissolved form, which is the form of the California Toxics Rule (CTR) water quality criteria indicated on the figures.



For aluminum the criteria used is 750 µg/L taken from the National Ambient Water Quality Criteria (NAWQC) acute value for a pH range of 6.5 to 9.0, as the CTR does not include aluminum. The range of pH values observed by Wildermuth within the San Juan Creek watershed was 8.1 – 8.6, which indicates that the NAWQC criteria is applicable to the San Juan watershed. For the wet years, the predicted mean annual aluminum concentration in discharges to Chiquita Creek decreases from 669 µg/L under pre-development conditions, to 599µg/L under developed with PDFs conditions, a reduction of about 10 percent. During dry years, the post-development with PDFs concentration is predicted to be about 592 µg/L and during all years, the post-developed with PDFs concentration is predicted to be 596 µg/L.

Table 5-11 compares the predicted trace metals concentrations with water quality criteria and observed data. In wet years under the developed with PDFs scenario, the mean annual concentrations in discharges to Chiquita Creek from the total project area are: cadmium 0.46 µg/L, copper 11 µg/L, lead 2.4 µg/L, and zinc 65 µg/L. The corresponding range in mean values for the four stations in the San Juan watershed monitored by Wildermuth are: cadmium 0.06 - 0.12 µg/L, copper 1.6 - 5.5 µg/L, lead 0.17 - 0.91 µg/L, and zinc 3.9 - 10.4 µg/L. All values are for the dissolved form. The runoff concentrations predicted by the model tend to be somewhat higher than the in-stream monitoring data, which may be related to a combination of dilution effects and re-partitioning effects.

As shown in Table 5-11, aluminum, cadmium, copper, lead, and zinc predicted mean annual concentrations are well below acute aquatic CTR and NAWQC criteria.

**Table 5-9: Predicted Average Annual Trace Metal Loads the Chiquita Sub-basin (Alternative B-4) (lbs)**

Modeled Area	Site Condition	Total Aluminum			Dissolved Cadmium			Dissolved Copper			Dissolved Lead			Dissolved Zinc		
		All Years	Dry Years	Wet Years	All Years	Dry Years	Wet Years	All Years	Dry Years	Wet Years	All Years	Dry Years	Wet Years	All Years	Dry Years	Wet Years
Chiquita Creek	Pre-Developed	228	140	415	0.16	0.12	0.24	3.3	2.4	5.3	0.6	0.4	1.1	28	21	44
	Developed	470	343	739	0.47	0.38	0.66	9.8	7.7	14.2	2.2	1.7	3.2	60	47	88
	Dev w/ PDFs	219	135	397	0.20	0.14	0.32	4.1	2.8	6.8	0.9	0.6	1.5	31	22	50
	Percent Change	-4	-4	-4	24	14	35	24	18	30	35	31	39	10	7	13
San Juan Creek	Pre-Developed	2.1	0.57	5.3	0.00	0.00	0.00	0.02	0.00	0.04	0.00	0.00	0.01	0.11	0.03	0.29
	Developed	58	48	80	0.11	0.09	0.15	1.9	1.6	2.7	0.3	0.3	0.5	10	8.0	13
	Dev w/ PDFs	141	118	191	0.10	0.08	0.14	3.2	2.6	4.3	0.7	0.6	0.9	11	9.4	16
	Percent Change	6638	20543	34800	27264	82461	14726	20354	62481	10785	17174	52769	9088	9884	30145	5282
Total Sub-basin Area	Pre-Developed	230	141	420	0.16	0.12	0.24	3	2	5	0.7	0.4	1.1	28	21	44
	Developed	528	390	819	0.58	0.47	0.81	12	9	17	2.5	2.0	3.7	70	55	101
	Dev w/ PDFs	361	253	588	0.30	0.22	0.46	7	5	11	1.5	1.1	2.4	42	31	65
	Percent Change	57	80	40	86	81	93	119	129	110	137	155	121	50	52	47

**Table 5-10: Predicted Average Annual Trace Metal Concentrations the Chiquita Sub-basin (Alternative B-4) (µg/L)**

Modeled Area	Site Condition	Total Aluminum			Dissolved Cadmium			Dissolved Copper			Dissolved Lead			Dissolved Zinc		
		All Years	Dry Years	Wet Years	All Years	Dry Years	Wet Years	All Years	Dry Years	Wet Years	All Years	Dry Years	Wet Years	All Years	Dry Years	Wet Years
Chiquita Creek	Pre-Developed	665	660	669	0.47	0.58	0.39	10	11	8	1.9	2.1	1.7	82	97	71
	Developed	542	529	556	0.54	0.59	0.50	11	12	11	2.5	2.6	2.4	69	73	66
	Dev w/ PDFs	596	592	599	0.54	0.62	0.49	11	12	10	2.4	2.6	2.3	84	97	75
	Percent Change	-10	-10	-10	15	6	26	16	9	21	26	21	30	3	0	5
San Juan Creek	Pre-Developed	679	679	679	0.12	0.12	0.12	5	5	5	1.3	1.3	1.3	37	37	37
	Developed	496	495	496	0.95	0.95	0.94	17	17	17	2.9	2.9	2.9	83	84	83
	Dev w/ PDFs	549	549	549	0.39	0.39	0.40	12	12	12	2.6	2.6	2.6	44	44	45
	Percent Change	-19	-19	-19	228	223	235	146	145	146	107	107	108	20	18	22
Total Sub-basin Area	Pre-Developed	665	661	669	0.47	0.58	0.38	10	11	8	1.9	2.1	1.7	82	97	71
	Developed	537	524	550	0.59	0.63	0.55	12	13	11	2.6	2.7	2.5	71	74	68
	Dev w/ PDFs	576	571	582	0.48	0.51	0.46	12	12	11	2.5	2.6	2.4	68	71	65
	Percent Change	-13	-14	-13	3	-13	20	21	10	30	31	22	37	-17	-27	-9

**Table 5-11: Comparison of Predicted Trace Metals Concentrations with Water Quality Criteria and Observed In-Stream Concentrations the Chiquita Sub-basin (Alternative B-4)**

Trace Metals	Predicted Average Annual Concentration <sup>1</sup> (µg/L)			California Toxics Rule Criteria <sup>2</sup> (µg/L)	Observed Range of In-Stream Concentrations <sup>3</sup> (µg/L)
	All Years	Dry Years	Wet Years		
Total Aluminum	576	571	582	750 <sup>4</sup>	Not Monitored
Dissolved Cadmium	0.48	0.51	0.46	5.2	None Detected – 0.09
Dissolved Copper	12	12	11	15.9	2.1 – 4.0
Dissolved Lead	2.5	2.6	2.4	78.7	None Detected – 3.9
Dissolved Zinc	68	71	65	137	None Detected – 15.0

<sup>1</sup>Modeled concentration for total project developed conditions with PDFs.

<sup>2</sup>Hardness = 120 mg/L, minimum value of monitoring data in San Juan Creek.

<sup>3</sup>Mean observed in San Juan watershed stations.

<sup>4</sup>NAWQC criteria for pH 6.5 – 9.0.

### **5.2.3 Impacts on Pollutants of Concern – Alternative B-9**

Impact to pollutants of concern under the B-9 alternative would be as follows. Runoff loads and concentrations of TSS would decrease with the proposed development. Nutrient loads and concentrations would generally increase for TKN. However, concentrations would not increase for nitrate-nitrogen, the more bioavailable form of nitrogen nutrient. Total phosphorus loads and concentrations also are projected to increase; however, runoff concentrations are projected to be much less than baseline instream observations. Thus the potential for stimulating algal growth in Chiquita Creek is limited. Trace metal loads and concentrations are also projected to increase; however, concentrations are likely to be much lower than CTR and NAWQA criteria. In part this reflects the effects of elevated hardness which is typical of these stream systems.

### **5.2.4 Findings of Significance**

#### ***Alternative B-4***

#### ***Hydrologic Conditions of Concern and Significance Thresholds***

The following discusses the implications of the flow duration and water balance results on the hydrologic conditions of concern.

#### **1. Increase Stormwater Runoff Volumes, Peak Discharges, and Flow Duration**

Significance Threshold A: Substantially alter the existing drainage pattern of the site or area, including alteration of the course of a stream or river, in a manner that would cause substantial erosion or siltation.

The WQMP was designed specifically to preserve and protect the existing drainage patterns in the main stem of Chiquita Creek and in side canyon tributaries. Specifically, WQMP facilities will be located to the extent feasible in the upper ends of the side canyons and will be operated to mimic the current conditions in the tributary channels. Drainage patterns will be altered within the development bubble where drainage infrastructure will be provided; however, drainage swales or other more natural drainage features will be utilized to the extent feasible.

Significance Threshold B: Substantially increase the frequencies or duration of channel adjusting flows.

Changes in the frequency and duration of flows were analyzed for each development bubble with the aid of the EPA SWMM Model. The combined control system for each development bubble was sized and configured to match, to the extent possible, the flow durations over the entire range of predicted flows, including flows up to and beyond the 10 year peak flow event. If flow duration is matched, peak flows are also matched. A water balance was conducted that took into account the effects of anticipated irrigation and the operation of the PDFs. The results of the water balance indicated that surface water runoff volume to Chiquita Creek would increase slightly over the pre-developed condition, but in absolute terms, the predicted increase is less than changes associated with climatic conditions. On this basis, the effect of the proposed development in Cañada Chiquita on flow duration and volume within the range of channel adjusting flows is determined to be less than significant.

## 2. Decreased Infiltration and Groundwater Recharge

Significance Threshold A: Substantially deplete groundwater supplies or interfere substantially with groundwater recharge that would cause a net deficit in aquifer volumes or lowering of the local groundwater table.

The significance threshold for this hydrologic condition of concern is a reduction in post-development infiltration volumes over pre-development infiltration volumes that would cause a significant reduction in groundwater recharge. The water balance indicates that infiltration volumes will likely increase over pre-development conditions, the extent of which will depend on whether it is a wet or dry cycle. On this basis, the impact of the proposed project on decreasing infiltration and groundwater recharge is considered less than significant.

## 3. Change in Base Flow

Significance Criteria A: Substantially increase or decrease base flows as to negatively impact riparian habitat.

A comparison of the water balance results with observed base flow observations indicated that base flows were projected to increase by about 200 acre-ft/yr. This increase in base flows was determined to be potentially beneficial in terms of improving the health of existing vegetation or providing for additional riparian habitat. To the extent that such increases could affect San Juan

Creek, additional water could potentially provide additional habitat for the arroyo toad during the sensitive breeding season.

Significance Threshold B: Substantially increase or decrease low flow estimates where high groundwater elevations are considered important.

Sustaining high groundwater elevations are important where riparian vegetation depends upon ground water within two to ten feet of the ground surface, and where ground water is pumped for water supply. High ground water is particularly important where sustaining both uses, concurrently and conjunctively, as is the case in lower San Juan Creek. The projected increases in base flow, although modest on the scale of the San Juan watershed, can add substantially to the reliability of recharge during dry years, helping to sustain riparian vegetation in areas where it is critical to bank stability within the cities of San Juan Capistrano and Capistrano Beach. Additionally, more reliable recharge and recharge earlier in the season will allow more effective development of ground water from the downstream alluvial aquifer of lower San Juan Creek by enabling pumping earlier in the winter, during drier years when recharge might otherwise be minimal, and by diluting with fresher recharge the concentrated salts introduced into the aquifer from leaching of local bedrock.

#### *Pollutants of Concern*

The following are the conclusions regarding the significance of impacts for the pollutants of concern under wet and dry weather conditions.

*Sediments:* Mean total suspended solids concentrations are predicted to be less in the post development condition than in the existing conditions because of the stabilization associated with urban landscaping and paving. In order to preserve the coarse sediment supply, water treatment facilities are designed to capture and treat runoff from the developed portions of the B-4 alternative which would tend to generate finer solids, and to bypass larger flows that are more likely to carry coarser sediments needed to maintain a stable equilibrium in the main stem channel. On this basis the impact of the B-4 alternative on suspended sediments is considered less than significant.

*Nutrients (Nitrogen and Phosphorous):* The local geology results in relatively high background phosphorous concentrations and suggests that the systems are likely to be nitrogen limited. Projection of concentrations for nitrate-nitrogen, the more bioavailable form of nitrogen, indicate a reduction in concentration associated with the implementation of controls that specifically address nitrate-nitrogen. On this basis, the impact of the B-4 alternative on nutrients and algal stimulation is considered less than significant.

*Trace Metals:* Mean concentrations of total aluminum and dissolved cadmium, copper, lead, and zinc are predicted to increase relative to predicted concentrations under existing conditions. However, mean concentrations of aluminum, cadmium, copper, lead, and zinc are well below

benchmark NAWQC and CTR criteria. On this basis, the impact of the B-4 alternative on trace metals is less than significant.

### ***Alternative B-9***

#### *Hydrologic Conditions of Concern and Significance Thresholds*

The following discusses the implications of the flow duration and water balance results on the hydrologic conditions of concern.

#### 1. Increased Stormwater Runoff Volume, Peak Discharges, and Flow Duration

Significance Threshold A. Substantially alter the existing drainage pattern of the site or area, including alteration of the course of a stream or river, in a manner that would cause substantial erosion or siltation.

The WQMP was designed specifically to preserve and protect the existing drainage patterns in the main stem of Chiquita Creek and in the side canyon tributaries. Drainage patterns would be altered within the development bubbles where drainage infrastructure will be provided. However, drainage swales or other more natural drainage features will be installed to the extent feasible.

Significance Threshold B: Substantially increase the frequency and duration of channel adjusting flows.

Changes in the frequency and duration of channel adjusting flows would be effectively managed by incorporating flow duration controls in the design of the flow control and water quality basins. This design addresses a range of flows including the 2 and 10 year peak flow events required to be analyzed by the Local WQMP.

#### 2. Decreased Infiltration and Groundwater Recharge

Significance Threshold A: Substantially deplete groundwater supplies or interfere substantially with groundwater recharge that would cause a net deficit in aquifer volumes or lowering of the local groundwater table.

Excess runoff volume from the proposed development would be infiltrated, thereby increasing groundwater recharge and raising the local groundwater table, at least during the wet season.

#### 3. Change in Base flow

Significance Criteria A: Substantially increase or decrease base flows as to negatively impact riparian habitat.

Base flows in the lower portion of Chiquita Creek are likely to increase in response to the utilization of infiltration basins for capturing excess surface runoff. Current information

suggests that the increase in base flows could provide needed water and improve the condition of the existing riparian vegetation. As with the B4 alternative, increased reliability of base flows would occur both in Chiquita and further downstream along San Juan Creek.

Significance Threshold B: Substantially increase or decrease low flow estimates where high groundwater elevations are considered important.

High groundwater elevations are important where groundwater is pumped for water supply. This is the case in lower San Juan Creek and the projected increase in base flows, although modest on the scale of the San Juan Creek watershed, could slightly improve groundwater levels.

Based on the above considerations and conclusions, the impact of the B-9 alternative on hydrologic conditions of concern is considered less than significant.

### ***Pollutants of Concern***

The following are the conclusions regarding the significance of impacts for the pollutants of concern under wet and dry weather conditions.

*Suspended Solids:* Suspended concentrations and loads in runoff are projected to decrease under the B-9 alternative because of the effects of urban landscaping, impervious surfaces, and treatment achieved in the combined control system. In order to preserve the overall sediment supply to the streams, treatment will focus on urban runoff only and will bypass higher flows that may contain more coarse sediment. On this basis, the impact of the B-9 alternative on suspended solids is considered less than significant.

*Nutrients (Nitrogen and Phosphorus):* The concentrations and loads of the more biologically available form of nitrogen, namely nitrate-nitrogen, are not projected to increase. The increase in runoff total phosphorus concentrations are much less than observed in-stream concentrations, which would suggest that the system is currently high in phosphorus and therefore more likely to be nitrogen limited. On this basis, the impact of the B-9 alternative on nutrients is considered less than significant.

*Trace Metals:* Mean concentrations and loads of trace metals are generally projected to increase with development, however in all cases, predicted mean concentrations are well below CTR and NAWQA acute aquatic criteria. On this basis, the impact of the B-9 alternative on trace metals is considered less than significant.

## **5.3 IMPACT ANALYSIS FOR THE CAÑADA GOBERNADORA SUB-BASIN**

This section evaluates the impacts of the proposed development on pollutants of concern and hydrologic conditions of concern, taking into account the PDFs associated with the WQMP described in Chapter 4. The methods of analysis and those PDFs that are similar to those described for Chiquita Canyon in Section 5.2 are not re-iterated here.



### **5.3.1 Impacts on Hydrologic Conditions of Concern**

#### ***Alternative B-4***

##### *Hydrologic Condition of Concern #1: Increased Stormwater Runoff Flow Rate, Volume, and Flow Duration*

#### Flow Duration Analysis

Although the flow duration analysis was conducted for each catchment affected by development, the results are presented here for one example. Figure 5-13 shows the results of the flow duration analysis for Catchment 3, which contains approximately 274 acres of single family residential and transportation land uses and approximately 86 acres of open space. The impervious percentage for the developed area is estimated to be about 44 percent. Also shown on the figure are the estimated 2 and 10 year return period post-development peak flows. These flows were estimated based on a frequency analysis of peak flows from the SWMM output for the 53 year rainfall record. The figure indicates that the flow controls effectively match the pre-development flow duration curve for a range of flows up to and beyond the 10 year peak flow. These results indicate that matching pre-development flow duration up to the 10 year peak flow was possible utilizing the combined control system in Catchment 3. Similar success with flow duration matching was achieved in other catchments in Gobernadora in which development is proposed.

#### Water Balance Analysis

The potential role of irrigation in the Gobernadora Sub-basin is illustrated in Figure 5-14, which compares predicted irrigation volumes with historic precipitation volumes. Figure 5-14 shows that irrigation effects are most pronounced during the dry summer months. Considering all years, irrigation will add about 11 percent to the overall water balance for the sub-basin as a whole. Most, if not all, of this water will be infiltrated and/or evapotranspired in the combined control system.

The irrigation estimates then were incorporated into the SWMM modeling and SWMM results for surface runoff, evapotranspiration, and groundwater outflow were compiled in the form of annual water balances. These water balances, developed as described in Chapter 3, are shown for the Gobernadora Sub-basin in Figure 5-15 and are tabulated in Tables 5-12, 5-13, and 5-14 for all years, dry years, and wet years respectively.

Note that the effects of the existing Coto de Caza development in Upper Gobernadora and Wagon Wheel are included in the Tables 5-12, 5-13, and 5-14.

Table 5-15 isolates the effects of Coto de Caza from that of the proposed development in Lower Gobernadora. As shown in Table 5-15, the model predictions indicate that current runoff from Coto de Caza is about 1,378 acre-ft compared to an estimated 258 acre-ft from the catchments

below Coto de Caza. Thus runoff from Coto de Caza is predicted to currently contribute about 85 percent of the sub-basin surface flow.

Table 5-15 also isolates the effect of the proposed development. The effect of the proposed development on sub-basin hydrology can be examined by comparing the mean annual values of runoff and groundwater outflow for the “post-development with PDFs” condition with the pre-development condition. For all years, which was the period used for sizing the control facilities, the surface runoff is predicted to remain essentially unchanged.

The Gobernadora Multi-purpose Basin, presently under consideration, is intended to improve hydrologic and water quality conditions in Lower Gobernadora Creek and San Juan Creek. A conceptual layout for these facilities, developed by Balance Hydrologics, calls for approximately a 400 acre-foot basin with a four day drain time. Water from the basin would be pumped to a non-domestic water supply reservoir. The operation of the basin was modeled in SWMM for the 53 year period of record. A water balance for existing conditions (no facility) and with the Multi-purpose Basin are presented in Table 5-16. The table indicates that for all of the 53 year period of record, the basin would reduce surface runoff to lower Gobernadora from an estimated 3.4 inches (1378 acre-ft/yr) to 0.4 inches (161 acre-ft/yr) or approximately 90 percent. Expressed a different way, runoff volume entering lower Gobernadora would be reduced from about 23 percent of precipitation to about 3 percent of precipitation, corresponding approximately to pre-urban conditions. Water from the Gobernadora Multi-purpose Basin would be pumped to a non-domestic water supply reservoir. The reservoir operation was not modeled, and the assumption is that demand for non-domestic water and reservoir capacity would not constrain pumping from the Multi-purpose Basin.

#### *Hydrologic Condition of Concern #2: Decreased Infiltration and Groundwater Recharge*

Given the reliance on infiltration in the combined control system, changes to groundwater infiltration and outflow are more pronounced. As indicated in Table 5-15, groundwater outflow from the development in lower Gobernadora is predicted to increase from 847 acre-ft under existing conditions to 1,140 acre-ft under the developed condition for an increase of about 300 acre-ft or about 35 percent. The corresponding increase for dry years is about 290 acre-ft or 50 percent, and 309 acre-ft or 21 percent during the wet years. The largest effect is therefore during the dry years.

The projected increase in groundwater infiltration and outflows will not reduce recharge, but would increase recharge instead. However, groundwater levels are already high near the mouth of Cañada Gobernadora because of the apparent groundwater barrier. There is concern that these levels would prevent groundwater infiltration in these areas. If this were the case, other options, such as diversion of excess runoff directly to San Juan Creek would be considered and would be provided for as part through the adaptive management program.

### *Hydrologic Condition of Concern #3: Changed Base Flows*

The increase in infiltration and groundwater outflow leads to increases in base flows. As discussed above, the increase in base flows would be about 300 acre-ft which would constitute an increase of about 50 percent during dry years and about 20 percent during wet years. Analysis of vegetation in the GERA indicates that additional water could improve the condition of riparian vegetation in the GERA. The additional water could also possibly be used to increase the riparian habitat if the erosion effects caused by surface and subsurface flows from existing upstream development can be reduced by the proposed Gobernadora Multi-Purpose Basin (if constructed).

If increases in base flows were determined to be detrimental, the proposed Gobernadora Multi-purpose Basin also could be used to reduce base flow contributions from Coto de Caza to offset increases in lower Gobernadora associated with the proposed development. A second alternative, as discussed above, would involve routing excess flows directly to San Juan Creek, thereby reducing or eliminating the need for infiltration, at least in those catchments in lower Gobernadora close to San Juan Creek. This management option would also be a management measure that could be employed if the proposed Gobernadora Multi-purpose Basin is not constructed.

### ***Alternative B-9***

Figure 1-4 shows the proposed development areas under the B-9 alternative, which can be compared with the corresponding development areas under the B-4 alternative shown in Figure 1-3. Table 4-9 lists the proposed land uses in the Gobernadora Sub-basin under each alternative. As indicated in the table and figures, the proposed development under the B-9 alternative would be about 1,037 acres versus 1,098 acres for the B-4 alternative. The only significant difference between Alternatives B-4 and B-9 is the reduced acreage and reconfiguration of the estates in upper Gobernadora to accommodate a larger wildlife movement corridor under Alternative B-9.

Impacts on hydrologic conditions of concern for the proposed development in the lower portion of Cañada Gobernadora would be similar to impacts identified for this area under the B-4 alternative. Effective management of increased channel forming flows has been shown to be feasible using a combined flow duration and water quality treatment basin whose outlet structure is designed to mimic the pre-development runoff flow duration. This control includes the 2 and 5 year return period flows. Depending on location, excess flows would be infiltrated, thereby increasing recharge and base flows; diverted to San Juan Creek (i.e., Catchment 1 just east of Chiquadora Ridge); or stored in non-domestic water supply reservoirs for irrigation. Increased base flows could be beneficial to existing habitat in the GERA and possibly for increased riparian habitat.

**Table 5-12: Gobernadora Sub-basin Water Balance\*, All Years (Alternative B-4) (inches (acre-ft))**

	Pre-Development <sup>1</sup>						Post-Development with PDFs <sup>2</sup>							
	INFLOW	OUTFLOW					INFLOW			OUTFLOW				
	Precipitation	Runoff to Gobernadora Creek	Runoff to San Juan Creek	GW Outflow	ET	Total	Precipitation	Irrigation	Total	Runoff to Gobernadora Creek	Runoff to San Juan Creek	GW Outflow	ET	Total
<b>OCT</b>	0.3 (172)	0.0 (16)	0.0 (0)	0.2 (116)	0.3 (185)	0.5 (317)	0.3 (171)	0.1 (64)	0.4 (235)	0.0 (16)	0.0 (2)	0.2 (125)	0.4 (245)	0.7 (388)
<b>NOV</b>	1.5 (891)	0.2 (131)	0.0 (0)	0.2 (103)	0.5 (267)	0.9 (501)	1.5 (888)	0.0 (27)	1.6 (915)	0.2 (135)	0.0 (13)	0.2 (135)	0.5 (282)	1.0 (565)
<b>DEC</b>	2.0 (1175)	0.3 (193)	0.0 (0)	0.2 (111)	0.5 (289)	1.0 (593)	2.0 (1172)	0.0 (20)	2.0 (1192)	0.3 (196)	0.0 (18)	0.3 (164)	0.5 (284)	1.1 (662)
<b>JAN</b>	3.4 (1974)	0.6 (376)	0.0 (0)	0.3 (169)	0.6 (337)	1.5 (881)	3.4 (1969)	0.0 (16)	3.4 (1985)	0.6 (375)	0.1 (30)	0.4 (246)	0.5 (322)	1.7 (973)
<b>FEB</b>	3.1 (1826)	0.8 (483)	0.0 (2)	0.4 (252)	0.7 (430)	2.0 (1167)	3.1 (1821)	0.0 (12)	3.1 (1834)	0.8 (480)	0.0 (28)	0.5 (310)	0.7 (406)	2.1 (1225)
<b>MAR</b>	2.6 (1517)	0.5 (301)	0.0 (0)	0.6 (354)	1.0 (602)	2.1 (1258)	2.6 (1513)	0.1 (49)	2.7 (1562)	0.5 (296)	0.0 (24)	0.7 (400)	1.0 (571)	2.2 (1292)
<b>APR</b>	1.0 (616)	0.1 (84)	0.0 (0)	0.5 (296)	1.2 (695)	1.8 (1074)	1.0 (614)	0.2 (94)	1.2 (708)	0.1 (83)	0.0 (9)	0.5 (321)	1.1 (656)	1.8 (1069)
<b>MAY</b>	0.4 (206)	0.0 (19)	0.0 (0)	0.4 (237)	1.2 (676)	1.6 (932)	0.3 (205)	0.2 (122)	0.6 (327)	0.0 (19)	0.0 (3)	0.4 (250)	1.2 (678)	1.6 (950)
<b>JUN</b>	0.1 (73)	0.0 (5)	0.0 (0)	0.3 (188)	0.9 (539)	1.2 (732)	0.1 (73)	0.2 (146)	0.4 (218)	0.0 (5)	0.0 (1)	0.3 (194)	1.1 (644)	1.4 (844)
<b>JUL</b>	0.0 (17)	0.0 (1)	0.0 (0)	0.3 (166)	0.7 (384)	0.9 (551)	0.0 (17)	0.3 (150)	0.3 (166)	0.0 (1)	0.0 (0)	0.3 (169)	0.9 (528)	1.2 (698)
<b>AUG</b>	0.1 (60)	0.0 (6)	0.0 (0)	0.2 (145)	0.5 (274)	0.7 (426)	0.1 (59)	0.2 (140)	0.3 (199)	0.0 (7)	0.0 (1)	0.3 (150)	0.7 (407)	1.0 (564)
<b>SEP</b>	0.3 (183)	0.0 (22)	0.0 (0)	0.2 (125)	0.3 (201)	0.6 (348)	0.3 (182)	0.2 (101)	0.5 (283)	0.0 (22)	0.0 (2)	0.2 (133)	0.5 (294)	0.8 (452)
<b>Total</b>	<b>14.8 (8708)</b>	<b>2.8 (1636)</b>	<b>0.0 (2)</b>	<b>3.9 (2262)</b>	<b>8.3 (4879)</b>	<b>14.9 (8780)</b>	<b>14.8 (8685)</b>	<b>1.6 (940)</b>	<b>16.4 (9625)</b>	<b>2.8 (1635)</b>	<b>0.2 (132)</b>	<b>4.4 (2598)</b>	<b>9.1 (5317)</b>	<b>16.5 (9682)</b>

\* Includes effects of Coto de Caza

<sup>1</sup>Pre-development sub-basin area = 7049 acres. Volumes given are inches over the sub-basin area.

<sup>2</sup>Post-development sub-basin area = 7033 acres. Volumes given are inches over the sub-basin area.

**Table 5-13: Gobernadora Sub-basin Water Balance\*, Dry Years (Alternative B-4) (inches (acre-ft))**

	Pre-Development <sup>1</sup>						Post-Development with PDFs <sup>2</sup>							
	INFLOW	OUTFLOW					INFLOW			OUTFLOW				
	Precipitation	Runoff to Gobernadora Creek	Runoff to San Juan Creek	GW Outflow	ET	Total	Precipitation	Irrigation	Total	Runoff to Gobernadora Creek	Runoff to San Juan Creek	GW Outflow	ET	Total
<b>OCT</b>	0.3 (172)	0.0 (15)	0.0 (0)	0.1 (85)	0.3 (202)	0.5 (302)	0.3 (172)	0.1 (63)	0.4 (235)	0.0 (16)	0.0 (2)	0.2 (95)	0.4 (258)	0.6 (371)
<b>NOV</b>	1.6 (961)	0.2 (143)	0.0 (0)	0.1 (76)	0.5 (284)	0.9 (503)	1.6 (959)	0.0 (27)	1.7 (985)	0.3 (147)	0.0 (14)	0.2 (112)	0.5 (296)	1.0 (570)
<b>DEC</b>	2.1 (1245)	0.4 (206)	0.0 (0)	0.1 (86)	0.5 (299)	1.0 (591)	2.1 (1242)	0.0 (20)	2.2 (1262)	0.4 (209)	0.0 (19)	0.2 (142)	0.5 (291)	1.1 (662)
<b>JAN</b>	2.5 (1469)	0.4 (252)	0.0 (0)	0.2 (104)	0.6 (324)	1.2 (680)	2.5 (1465)	0.0 (16)	2.5 (1481)	0.4 (255)	0.0 (23)	0.3 (172)	0.5 (309)	1.3 (758)
<b>FEB</b>	2.2 (1280)	0.4 (234)	0.0 (0)	0.2 (130)	0.7 (401)	1.3 (764)	2.2 (1277)	0.0 (12)	2.2 (1289)	0.4 (230)	0.0 (19)	0.3 (186)	0.6 (374)	1.4 (810)
<b>MAR</b>	1.7 (1012)	0.3 (148)	0.0 (0)	0.3 (183)	1.0 (587)	1.6 (917)	1.7 (1009)	0.1 (50)	1.8 (1059)	0.2 (142)	0.0 (16)	0.4 (226)	0.9 (554)	1.6 (938)
<b>APR</b>	1.1 (638)	0.2 (88)	0.0 (0)	0.3 (168)	1.2 (714)	1.7 (970)	1.1 (637)	0.2 (94)	1.2 (730)	0.1 (88)	0.0 (9)	0.3 (198)	1.2 (677)	1.7 (972)
<b>MAY</b>	0.3 (204)	0.0 (16)	0.0 (0)	0.2 (137)	1.2 (707)	1.5 (859)	0.3 (203)	0.2 (121)	0.6 (324)	0.0 (16)	0.0 (3)	0.3 (152)	1.2 (711)	1.5 (882)
<b>JUN</b>	0.1 (53)	0.0 (3)	0.0 (0)	0.2 (111)	1.0 (566)	1.2 (680)	0.1 (52)	0.2 (146)	0.3 (198)	0.0 (3)	0.0 (1)	0.2 (119)	1.2 (677)	1.4 (799)
<b>JUL</b>	0.0 (22)	0.0 (1)	0.0 (0)	0.2 (100)	0.7 (435)	0.9 (536)	0.0 (22)	0.3 (150)	0.3 (171)	0.0 (1)	0.0 (0)	0.2 (106)	1.0 (578)	1.2 (685)
<b>AUG</b>	0.1 (67)	0.0 (8)	0.0 (0)	0.2 (89)	0.5 (297)	0.7 (394)	0.1 (67)	0.2 (140)	0.4 (206)	0.0 (8)	0.0 (1)	0.2 (96)	0.7 (429)	0.9 (533)
<b>SEP</b>	0.3 (173)	0.0 (21)	0.0 (0)	0.1 (78)	0.4 (212)	0.5 (310)	0.3 (173)	0.2 (101)	0.5 (274)	0.0 (21)	0.0 (2)	0.1 (88)	0.5 (304)	0.7 (416)
<b>Total</b>	<b>12.4 (7297)</b>	<b>1.9 (1133)</b>	<b>0.0 (0)</b>	<b>2.3 (1346)</b>	<b>8.6 (5027)</b>	<b>12.8 (7507)</b>	<b>12.4 (7277)</b>	<b>1.6 (939)</b>	<b>14.0 (8217)</b>	<b>1.9 (1137)</b>	<b>0.2 (110)</b>	<b>2.9 (1690)</b>	<b>9.3 (5458)</b>	<b>14.3 (8394)</b>

\*Includes effects of Coto de Caza

<sup>1</sup>Pre-development sub-basin area = 7049 acres. Volumes given are inches over the sub-basin area.

<sup>2</sup>Post-development sub-basin area = 7033 acres. Volumes given are inches over the sub-basin area.

**Table 5-14: Gobernadora Sub-basin Water Balance\*, Wet Years (Alternative B-4) (inches (acre-ft))**

	Pre-Development <sup>1</sup>						Post-Development with PDFs <sup>2</sup>							
	INFLOW	OUTFLOW					INFLOW			OUTFLOW				
	Precipitation	Runoff to Gobernadora Creek	Runoff to San Juan Creek	GW Outflow	ET	Total	Precipitation	Irrigation	Total	Runoff to Gobernadora Creek	Runoff to San Juan Creek	GW Outflow	ET	Total
<b>OCT</b>	0.3 (171)	0.0 (17)	0.0 (0)	0.3 (182)	0.3 (151)	0.6 (350)	0.3 (170)	0.1 (64)	0.4 (234)	0.0 (17)	0.0 (2)	0.3 (189)	0.4 (217)	0.7 (426)
<b>NOV</b>	1.3 (741)	0.2 (106)	0.0 (0)	0.3 (158)	0.4 (232)	0.8 (496)	1.3 (739)	0.0 (27)	1.3 (766)	0.2 (110)	0.0 (11)	0.3 (184)	0.4 (252)	0.9 (556)
<b>DEC</b>	1.7 (1027)	0.3 (166)	0.0 (0)	0.3 (163)	0.5 (268)	1.0 (597)	1.7 (1024)	0.0 (20)	1.8 (1044)	0.3 (167)	0.0 (16)	0.4 (210)	0.5 (268)	1.1 (662)
<b>JAN</b>	5.2 (3045)	1.1 (638)	0.0 (0)	0.5 (307)	0.6 (362)	2.2 (1307)	5.2 (3037)	0.0 (16)	5.2 (3053)	1.1 (628)	0.1 (46)	0.7 (404)	0.6 (350)	2.4 (1428)
<b>FEB</b>	5.1 (2983)	1.7 (1010)	0.0 (6)	0.9 (510)	0.8 (492)	3.4 (2019)	5.1 (2975)	0.0 (12)	5.1 (2987)	1.7 (1008)	0.1 (47)	1.0 (573)	0.8 (474)	3.6 (2104)
<b>MAR</b>	4.4 (2585)	1.1 (627)	0.0 (0)	1.2 (718)	1.1 (635)	3.4 (1980)	4.4 (2579)	0.1 (48)	4.5 (2627)	1.1 (623)	0.1 (42)	1.3 (770)	1.0 (607)	3.5 (2041)
<b>APR</b>	1.0 (568)	0.1 (75)	0.0 (0)	1.0 (566)	1.1 (655)	2.2 (1296)	1.0 (566)	0.2 (95)	1.1 (662)	0.1 (73)	0.0 (8)	1.0 (581)	1.0 (613)	2.2 (1275)
<b>MAY</b>	0.4 (209)	0.0 (25)	0.0 (0)	0.8 (451)	1.0 (611)	1.8 (1087)	0.4 (209)	0.2 (123)	0.6 (332)	0.0 (25)	0.0 (3)	0.8 (457)	1.0 (608)	1.9 (1094)
<b>JUN</b>	0.2 (116)	0.0 (10)	0.0 (0)	0.6 (352)	0.8 (482)	1.4 (843)	0.2 (116)	0.2 (146)	0.4 (262)	0.0 (10)	0.0 (1)	0.6 (353)	1.0 (575)	1.6 (941)
<b>JUL</b>	0.0 (6)	0.0 (0)	0.0 (0)	0.5 (306)	0.5 (275)	1.0 (581)	0.0 (6)	0.3 (150)	0.3 (156)	0.0 (0)	0.0 (0)	0.5 (305)	0.7 (422)	1.2 (727)
<b>AUG</b>	0.1 (44)	0.0 (4)	0.0 (0)	0.4 (264)	0.4 (225)	0.8 (493)	0.1 (44)	0.2 (140)	0.3 (183)	0.0 (4)	0.0 (1)	0.5 (264)	0.6 (359)	1.1 (628)
<b>SEP</b>	0.3 (202)	0.0 (24)	0.0 (0)	0.4 (223)	0.3 (180)	0.7 (427)	0.3 (202)	0.2 (101)	0.5 (302)	0.0 (24)	0.0 (3)	0.4 (229)	0.5 (272)	0.9 (528)
<b>Total</b>	<b>19.9 (11697)</b>	<b>4.6 (2701)</b>	<b>0.0 (7)</b>	<b>7.2 (4201)</b>	<b>7.8 (4567)</b>	<b>19.5 (11475)</b>	<b>19.9 (11666)</b>	<b>1.6 (943)</b>	<b>21.5 (12609)</b>	<b>4.6 (2691)</b>	<b>0.3 (180)</b>	<b>7.7 (4520)</b>	<b>8.6 (5018)</b>	<b>21.2 (12408)</b>

\* Includes effects of Coto de Caza

<sup>1</sup>Pre-development sub-basin area = 7049 acres. Volumes given are inches over the sub-basin area.

<sup>2</sup>Post-development sub-basin area = 7033 acres. Volumes given are inches over the sub-basin area.

**Table 5-15: Gobernadora Sub-basin Average Annual Water Balance, Upper/Lower Sub-basin (Alternative B-4) (all values are acre-ft)**

Development Condition	Portion of Sub-basin	All Years					Dry Years					Wet Years				
		Runoff to Govern.	Runoff to SJC	GW flow to Govern.	GW flow to SJC	ET Total	Runoff to Govern.	Runoff to SJC	GW flow to Govern.	GW flow to SJC	ET Total	Runoff to Govern.	Runoff to SJC	GW flow to Govern.	GW flow to SJC	ET Total
Pre-Development	Coto de Caza/ Wagon Wheel	1378	0	1302	0	3477	972	0	708	0	3615	2237	0	2561	0	3185
	Lower Gobernadora	258	2	847	112	1403	161	0	580	58	1412	464	7	1411	228	1382
	Total Sub-basin	1636	2	2149	112	4879	1133	0	1288	58	5027	2701	7	3972	228	4567
Post-Development With PDFs	Coto de Caza/ Wagon Wheel	1378	0	1302	0	3477	972	0	708	0	3615	2237	0	2561	0	3185
	Lower Gobernadora	257	132	1140	155	1840	164	110	867	116	1843	454	180	1720	239	1833
	Total Sub-basin	1635	132	2442	155	5317	1137	110	1574	116	5458	2691	180	4281	239	5018

**Table 5-16: Effectiveness of Gobernadora Multi-purpose Basin (Alternative B-4) (inches (acre-ft))**

Climatic Period	Current Condition					Current Condition with Multi-purpose Basin					
	INFLOW	OUTFLOW				INFLOW	OUTFLOW				
	Precipitation	Runoff to Gobernadora Creek	GW Outflow	ET	Total	Precipitation	Withdrawal from Multi-purpose Basin	Runoff to Gobernadora (Bypass)	GW Outflow	ET	Total
<b>All Years</b>	14.9 (6108)	3.4 (1378)	3.2 (1302)	8.5 (3477)	15.1 (6157)	14.9 (6108)	3.0 (1232)	0.4 (161)	3.2 (1302)	8.5 (3485)	15.1 (6180)
<b>Dry Years</b>	12.5 (5119)	2.4 (972)	1.7 (708)	8.8 (3615)	12.9 (5295)	12.5 (5119)	2.2 (901)	0.1 (28)	1.7 (708)	8.9 (3622)	12.9 (5259)
<b>Wet Years</b>	20.1 (8203)	5.5 (2237)	6.3 (2561)	7.8 (3185)	19.5 (7983)	20.1 (8203)	4.7 (1933)	1.1 (443)	6.3 (2561)	7.8 (3185)	19.9 (8122)

In the case of Catchment 1, pre-development runoff is quite low and the increase with development would be pronounced. However San Juan Creek is a wide, braided stream with a coarse substrate that transports significant sediment loads supplied from sources in the upper San Juan watershed. The discharges from Catchment 1 would be small relative to comparable conditions in San Juan Creek, and consequently are not likely to adversely affect the hydrology and sediment transport processes in San Juan Creek.

### **5.3.2 Impacts on Pollutants of Concern – Alternative B-4**

The section presents the water quality modeling results used to address impacts of stormwater runoff on sediments, nutrients, and trace metals. The modeling analysis has been described in Chapter 3. In order to isolate the effects of the proposed development, the model results do not include the effects of existing development in Wagon Wheel and Coto de Caza. However, as indicated in the water balance discussion, the effect of runoff from existing upstream development is likely to dominate water quality conditions in Lower Gobernadora.

#### ***TSS Loads and Concentrations***

Figure 5-16 shows the mean annual loads and concentrations for TSS. Table 5-17 summarizes TSS loads and concentrations and shows the percent change associated with the proposed development. During wet years, the mean annual load to Gobernadora Creek, post-development with controls, is estimated to be about 71 tons, which is a decrease of about 45 percent over pre-development conditions. During dry years, the mean annual load is predicted to be 20 tons, which is about 55 percent lower than the pre-development condition. The reduction in TSS loads is typical of development, which has the effect of stabilizing soils with vegetation and covering soils with impervious surfaces.

Catchment 1 (just east of Chiquadora Ridge) is located on the western side and near the mouth of the Gobernadora Sub-basin. It is the only catchment in Gobernadora that currently discharges directly into San Juan Creek. The TSS loads to San Juan Creek from Catchment 1 are predicted to increase dramatically as the current runoff from this catchment into San Juan Creek is predicted to be only about 2 acre-ft/yr because of the infiltrative soil conditions. With development, the runoff volume is projected to increase to 132 acre-feet per year post-development with PDFs. So, although the TSS concentration is predicted to decrease by approximately 80 percent, the load will increase. It is important however to consider this increase in an absolute sense rather than as a percentage increase because, as just discussed, the projected pre-development loads are very small. Therefore any increase is large as a percent. In absolute terms, the additional sediment loads to the San Juan Creek will be quite small in comparison to sediment transport in San Juan Creek.

Table 5-18 shows the mean annual TSS concentration of 91 mg/L for the total project area during wet years and how it compares with water quality criteria and observed concentrations. The criterion for TSS in the San Diego Basin Plan is narrative and states that “levels shall not cause a nuisance or adversely affect beneficial uses as a result of controllable water quality



factors”. The combined control system is designed to detain and infiltrate 80 to 90 percent of the runoff and would address urban particulates containing other pollutants. The range of observed TSS data collected by Wildermuth at the four stations in the San Juan watershed was 368 to 1,372 mg/L, so the projected mean TSS concentration in the runoff is less than the range of observed data.

In summary, projected runoff loads and concentrations into Gobernadora Creek will decrease and will be less than observed instream concentrations reported by Wildermuth. For Catchment 1, which currently drains directly to San Juan Creek, loads will increase because under current conditions very little runoff is projected to discharge from this catchment. Nonetheless, the load from Catchment 1 is quite small compared to the large sediment flux carried by the San Juan system.

**Table 5-17: Predicted Average Annual TSS Loads and Concentrations for the Gobernadora Sub-basin (Alternative B-4)**

Modeled Area	Site Condition	TSS Load (metric tons)			TSS Concentration (mg/L)		
		All Years	Dry Years	Wet Years	All Years	Dry Years	Wet Years
Gobernadora Creek	Pre-Developed	71	44	128	224	224	224
	Developed	80	56	131	130	120	139
	Dev w/ PDFs	36	20	71	115	99	128
	Percent Change	-49	-55	-45	-48	-56	-43
San Juan Creek	Pre-Developed	0.7	0.1	1.9	224	224	224
	Developed	18.8	15.6	25.7	114	113	115
	Dev w/ PDFs	7.0	5.4	10.4	43	40	47
	Percent Change	952	6447	446	-81	-82	-79
Total Sub-basin Area	Pre-Developed	72	44	130	224	224	224
	Developed	99	71	157	126	119	134
	Dev w/ PDFs	43	25	81	91	75	105
	Percent Change	-40	-43	-38	-60	-66	-53

**Table 5-18: Comparison of Predicted TSS Concentration with Water Quality Objectives and Observed In-Stream Concentrations for the Gobernadora Sub-basin (Alternative B-4)**

Predicted Average Annual TSS Concentration <sup>1</sup> (mg/L)	San Diego Basin Plan Water Quality Objectives	Range of Observed In-stream Concentrations <sup>2</sup> (mg/L)
91	TSS levels shall not cause a nuisance or adversely affect beneficial uses as a result of controllable water quality factors	None Detected – 3,100

<sup>1</sup>Modeled concentration for total project developed conditions with PDFs in wet years.

<sup>2</sup>Range of means observed at four San Juan watershed stations during the wet years.

NA – not applicable

### *Nutrient Loads and Concentrations*

Figures 5-17, 5-18, and 5-19 show the mean annual loads and concentrations for nitrate nitrogen, TKN, and total phosphorus. Nitrate-nitrogen and ammonia-nitrogen (a portion of the TKN measurement) are important bio-available forms of nitrogen that can cause excessive algal growth in streams.

Table 5-19 summarizes nutrient loads and shows percent changes for all years, dry years, and wet years respectively, for each receiving water. Nitrate loads to Gobernadora Creek for development with PDFs range from about 276 lbs/yr during dry years to 930 lbs/yr during wet years, a decrease of about 36 to 46 percent. Mean annual TKN loads are projected to be about 824 lbs/yr during dry years and 2,260 lbs/yr during wet years, an increase of about 84 to 93 percent.

Table 5-20 summarizes nutrient concentrations and shows percent changes for all years, dry years, and wet years respectively, for each receiving water. Mean annual TKN concentrations in discharges to Gobernadora Creek from development with PDFs are predicted to be about 1.8 mg/L during all conditions. In comparison, Wildermuth found in-stream TKN to be between 0.7 and 2.9 (Table 5-21). Mean annual concentrations of nitrate-nitrogen are predicted to be about 0.8 mg/L during wet years and about 0.6 mg/L during dry years. Total phosphorus loads are predicted to increase with development, but the addition of controls reduced the increase in loads such that during the wet years the predicted load in discharges to Gobernadora Creek from development with PDFs is 331 lbs/yr, which is about a 112 percent increase over pre-development loads. During dry years, the mean annual load is predicted to be about 125 lbs/yr, which is about 130 percent greater than pre-development conditions.

As with Cañada Chiquita (Section 5.2), these predicted increases may be inflated because the existing runoff of total phosphorus is based on relatively low concentration of 0.27 mg/L derived

from the vacant land use station in the LA County database. Local geology suggests that concentrations in the runoff from undeveloped portions of the sub-basin could be higher.

Table 5-21 shows a comparison of the average annual concentrations of nutrients with observed data from Wildermuth. The water quality concern here is excessive algal growth. The Basin Plan narrative objective is “Concentrations of nitrogen and phosphorous, by themselves or in combination with other nutrients, shall be maintained at levels below those which stimulate algae and emergent plant growth.” As discussed earlier for the Chiquita Sub-basin, the systems appear to be nitrogen limited, and the loads and concentrations of the more bioavailable form of nitrogen, namely nitrate-nitrogen, are projected to decrease with development. Moreover, the combined control system includes constructed wetlands for treating dry weather flows and small storm flows. Runoff concentrations associated with larger events, that may only receive partial treatment, would benefit from dilution.

For the discharges to San Juan Creek from the “Chiquadora Catchment” (Catchment 1), the percent increases in nutrient loads are high because pre-development runoff from this catchment is predicted to be quite small. The increase in loads to a large system like San Juan Creek are less important than the effect on concentrations, which as discussed above are projected to be less than or in the lower range of observed concentrations in San Juan Creek.

**Table 5-19: Predicted Average Annual Nutrient Loads for the Gobernadora Sub-basin (Alternative B-4) (lbs)**

Modeled Area	Site Condition	Nitrate-N Load			TKN Load			Total Phosphorus Load		
		All Years	Dry Years	Wet Years	All Years	Dry Years	Wet Years	All Years	Dry Years	Wet Years
Gobernadora Creek	Pre-Developed	815	508	1465	684	427	1230	87	54	156
	Developed	1096	785	1753	3093	2439	4479	441	350	635
	Dev w/ PDFs	486	276	930	1285	824	2260	191	125	331
	Percent Change	-40	-46	-36	88	93	84	120	130	112
San Juan Creek	Pre-Developed	8	1.0	22	6	0.8	18	1	0.1	2
	Developed	276	229	377	1031	859	1396	145	121	196
	Dev w/ PDFs	125	99	181	619	501	870	101	82	140
	Percent Change	1536	10303	729	9557	62830	4652	12258	81181	5913

Modeled Area	Site Condition	Nitrate-N Load			TKN Load			Total Phosphorus Load		
		All Years	Dry Years	Wet Years	All Years	Dry Years	Wet Years	All Years	Dry Years	Wet Years
Total Sub-basin Area	Pre-Developed	823	509	1486	691	428	1248	88	54	158
	Developed	1372	1014	2130	4124	3298	5875	586	470	830
	Dev w/ PDFs	611	375	1111	1904	1325	3130	291	207	471
	Percent Change	-26	-26	-25	176	210	151	232	281	197

**Table 5-20: Predicted Average Annual Nutrient Concentrations for the Gobernadora Sub-basin (Alternative B-4) (mg/L)**

Modeled Area	Site Condition	Nitrate-N Concentration			TKN Concentration			Total Phosphorus Concentration		
		All Years	Dry Years	Wet Years	All Years	Dry Years	Wet Years	All Years	Dry Years	Wet Years
Gobernadora Creek	Pre-Developed	1.2	1.2	1.2	1.0	1.0	1.0	0.1	0.1	0.1
	Developed	0.8	0.8	0.8	2.3	2.4	2.2	0.3	0.3	0.3
	Dev w/ PDFs	0.7	0.6	0.8	1.9	1.9	1.9	0.3	0.3	0.3
	Percent Change	-39	-46	-34	91	91	90	123	128	119
San Juan Creek	Pre-Developed	1.2	1.2	1.2	1.0	1.0	1.0	0.1	0.1	0.1
	Developed	0.8	0.8	0.8	2.8	2.8	2.8	0.4	0.4	0.4
	Dev w/ PDFs	0.4	0.3	0.4	1.7	1.7	1.8	0.3	0.3	0.3
	Percent Change	-70	-72	-68	77	72	83	126	122	131

Modeled Area	Site Condition	Nitrate-N Concentration			TKN Concentration			Total Phosphorus Concentration		
		All Years	Dry Years	Wet Years	All Years	Dry Years	Wet Years	All Years	Dry Years	Wet Years
Total Sub-basin Area	Pre-Developed	1.2	1.2	1.2	1.0	1.0	1.0	0.1	0.1	0.1
	Developed	0.8	0.8	0.8	2.4	2.5	2.3	0.4	0.4	0.3
	Dev w/ PDFs	0.6	0.5	0.7	1.8	1.8	1.8	0.3	0.3	0.3
	Percent Change	-50	-56	-44	86	84	88	124	126	122

**Table 5-21: Comparison of Predicted Nutrient Concentrations with Observed In-Stream Concentrations for the Gobernadora Sub-basin (Alternative B-4)**

Nutrient	Predicted Average Annual Concentration <sup>1</sup> (mg/L)			Observed Range of In-Stream Concentrations <sup>2</sup> (mg/L)
	All Years	Dry Years	Wet Years	
Nitrate	0.6	0.5	0.7	0.15 – 1.5
TKN	1.8	1.8	1.8	None Detected – 3.0
Total Phosphorus	0.3	0.3	0.3	None Detected – 2.8

<sup>1</sup>Modeled concentration for developed conditions with PDFs in wet years.

<sup>2</sup>Range of means observed at four San Juan watershed stations during the wet years.

NA – not applicable

### **Trace Metals**

Figures 5-20, 5-21, 5-22, 5-23, and 5-24 and Tables 5-22 and 5-23 show the predicted mean annual loads and mean annual concentrations for aluminum, cadmium, copper, lead, and zinc for the three development scenarios and for the three climatic conditions. Except for aluminum, the concentrations are all in the dissolved form, which is the form of the California Toxics Rule water quality criteria indicated on the figures.

#### **Aluminum**

Figure 5-20 indicates the National Ambient Water Quality Criteria (NAWQC) acute value of 750 µg/L within the pH range of 6.5 to 9.0, as the CTR does not include aluminum. The range of pH

values observed by Wildermuth within the San Juan Creek watershed was 8.1 – 8.6, which indicates that the pH range is suitable for application of the NAWQC criteria. For the wet years, the mean annual concentration in discharges to Gobernadora Creek is predicted to range from 679 µg/L under pre-development conditions to 584 µg/L under developed with controls, a reduction of about 14 percent. During dry years, the post-development concentration with PDFs is predicted to be about 572 µg/L. This information would suggest that the mean aluminum concentration is likely not to exceed the NAWQA criteria in this sub-basin.

Table 5-24 compares the predicted trace metals concentrations with water quality criteria and observed data. The criteria for selected metals varies depending on hardness. A hardness value of 120 mg/L, which corresponds to the minimum observed in-stream hardness reported by Wildermuth, was used in estimating the criteria in Table 5-24. Thus the criteria are very conservative, i.e., likely represent a lower bound. In wet years under the developed with controls scenario, the mean annual concentrations in discharges from the total project area are: cadmium 0.33 µg/L, copper 9.5 µg/L, lead 2.9 µg/L, and zinc 40 µg/L. The corresponding range in mean values for the four stations in the San Juan watershed monitored by Wildermuth are: cadmium 0.06 - 0.12 µg/L, copper 1.6 - 5.5 µg/L, lead 0.17 - 0.91 µg/L, and zinc 3.9 - 10.4 µg/L. All values are for the dissolved phase. The predicted concentrations tend to be somewhat higher than the monitored in-stream data, which may reflect the higher TSS levels in the stream. TSS levels affect the geochemical partitioning between the dissolved and particulate phases. Specifically, higher TSS values may decrease the dissolved fraction of trace metals and increase the particulate fraction. Table 5-24 also indicates that the predicted concentrations are all well below the CTR criteria.

**Table 5-22: Predicted Average Annual Trace Metal Loads for the Gobernadora Sub-basin (Alternative B-4) (lbs)**

Modeled Area	Site Condition	Total Aluminum			Dissolved Cadmium			Dissolved Copper			Dissolved Lead			Dissolved Zinc		
		All Years	Dry Years	Wet Years	All Years	Dry Years	Wet Years	All Years	Dry Years	Wet Years	All Years	Dry Years	Wet Years	All Years	Dry Years	Wet Years
Gobernadora Creek	Pre-Developed	476	297	856	0.1	0.1	0.2	3.5	2.2	6.3	0.9	0.6	1.6	26	16	46
	Developed	731	533	1150	0.5	0.4	0.7	13.9	11.0	20.1	4.8	3.8	6.9	66	50	97
	Dev w/ PDFs	400	252	712	0.2	0.1	0.4	6.4	4.2	11.1	2.0	1.3	3.6	28	18	50
	Percent Change	-16	-15	-17	164	176	155	83	93	76	133	141	126	8	9	7
San Juan Creek	Pre-Developed	4.5	0.6	12.7	0.01	0	0	0	0.1	0.03	0.01	0	0.02	0.2	0.03	0.7
	Developed	199	165	271	0.13	0.1	0.2	3.2	5.3	3.9	1.7	1.4	2.3	14	12	19
	Dev w/ PDFs	196	163	267	0.13	0.1	0.2	3.2	5.2	3.8	1.0	0.8	1	14	11	19
	Percent Change	4294	29247	1997	16140	108886	7600	77878	5422	11531	12276	80429	6002	5597	38013	2612
Total Sub-basin Area	Pre-Developed	481	298	868	0.08	0.05	0.2	3.5	2.2	6.40	0.9	0.6	2	26	16	47
	Developed	930	698	1421	0.7	0.5	0.9	17.8	14.2	25.40	6.5	5.2	9	79	62	116
	Dev w/ PDFs	596	415	979	0.4	0.3	0.6	10.3	7.4	16.3	3.1	2.1	5	42	29	68
	Percent Change	24	39	13	312	378	264	189	238	154	245	291	212	60	80	45

**Table 5-23: Predicted Average Annual Trace Metal Concentrations for the Gobernadora Sub-basin (Alternative B-4) (µg/L)**

Modeled Area	Site Condition	Total Aluminum			Dissolved Cadmium			Dissolved Copper			Dissolved Lead			Dissolved Zinc		
		All Years	Dry Years	Wet Years	All Years	Dry Years	Wet Years	All Years	Dry Years	Wet Years	All Years	Dry Years	Wet Years	All Years	Dry Years	Wet Years
Gobernadora Creek	Pre-Developed	679	679	679	0.1	0.1	0.1	5.0	5.0	5.0	1.3	1.3	1.3	37	37	37
	Developed	537	522	551	0.4	0.4	0.4	10.2	10.7	9.7	3.5	3.7	3.3	48	49	47
	Dev w/ PDFs	578	572	584	0.3	0.3	0.3	9.3	9.6	9.1	3.0	3.0	2.9	40	40	40
	Percent Change	-15	-16	-14	168	173	163	86	92	82	136	139	134	10	8	11
San Juan Creek	Pre-Developed	679	679	679	0.12	0.12	0.12	5.00	5.00	5.00	1.25	1.25	1.25	37	37	37
	Developed	546	545	547	0.36	0.36	0.36	10.64	10.67	10.61	4.75	4.76	4.73	38	38	38
	Dev w/ PDFs	546	545	547	0.36	0.36	0.36	10.64	10.67	10.61	2.83	2.76	2.93	38	38	38
	Percent Change	-20	-20	-19	197	198	196	113	113	112	127	120	134	4	4	4
Total Sub-basin Area	Pre-Developed	679	679	679	0.12	0.12	0.12	5.00	5.00	5.00	1.25	1.25	1.25	37	37	37
	Developed	539	528	550	0.37	0.40	0.35	10.30	10.72	9.84	3.77	3.95	3.57	46	47	45
	Dev w/ PDFs	567	561	573	0.33	0.34	0.33	9.76	10.02	9.52	2.91	2.90	2.92	40	39	40
	Percent Change	-16	-17	-16	178	183	173	95	100	90	133	132	134	8	7	9



**Table 5-24: Comparison of Predicted Trace Metals Concentrations with Water Quality Criteria and Observed In-Stream Concentrations for the Gobernadora Sub-basin (Alternative B-4)**

Trace Metals	Predicted Average Annual Concentration <sup>1</sup> (µg/L)			California Toxics Rule Criteria <sup>2</sup> (µg/L)	Observed Range of In-Stream Concentrations <sup>3</sup> (µg/L)
	All Years	Dry Years	Wet Years		
Total Aluminum	567	561	573	750 <sup>4</sup>	Not Monitored
Dissolved Cadmium	0.33	0.34	0.33	5.2	None Detected – 0.09
Dissolved Copper	9.8	10.0	9.5	15.9	2.1 – 4.0
Dissolved Lead	2.9	2.9	2.9	78.7	None Detected – 3.9
Dissolved Zinc	40	39	40	137	None Detected – 15.0

<sup>1</sup>Modeled concentration for developed conditions with PDFs.

<sup>2</sup>Hardness = 120 mg/L, minimum value of monitoring data.

<sup>3</sup>Range of means observed at four San Juan watershed stations during the wet years.

<sup>4</sup>NAWQC criteria for pH 6.5 – 9.0.

### **5.3.3 Impacts on Pollutants of Concern – Alternative B-9**

Impact to pollutants of concern under the B-9 alternative would be as follows. Runoff loads and concentrations of TSS would generally decrease with the proposed development. Nutrient loads and concentrations would generally increase for TKN. However, concentrations and loads would not increase for nitrate-nitrogen, the more bioavailable form of nitrogen nutrient. Total phosphorus loads and concentrations also are projected to increase; however, runoff concentrations are projected to be much less than in-stream observations which would indicate that the current system is not phosphorus limited. Thus the potential for stimulating algal growth in Gobernadora Creek is limited. Trace metal loads and concentrations are also projected to increase, however concentrations are likely to be much lower than CTR and NAWQA criteria. In part this reflects the effects of elevated hardness which is typical of these stream systems.

Catchment 1 is a 307 acre area located just east of Chiquadora Ridge. Approximately 270 acres would be proposed for development. Runoff from this catchment would discharge directly to San Juan Creek. In this case, treatment will be provided prior to discharge, however infiltration facilities were deemed unnecessary because infiltration, especially of low flows, could be provided in the San Juan Creek stream channel. As a consequence, loads of most pollutants of concern increase substantially relative to the pre-development. In an absolute sense, the post-development loads are modest, and are quite low compared to baseline conditions in Central San Juan Creek.

### 5.3.4 Findings of Significance

#### *Alternative B-4*

##### *Hydrologic Conditions of Concern and Significance Thresholds*

The following discusses the implications of the water balance results on the hydrologic conditions of concern.

#### 1. Increased Stormwater Runoff Flowrate, Volume and Flow Duration

Significance Threshold A: Substantially alter the existing drainage pattern of the site or area, including alteration of the course of a stream or river, in a manner that would cause substantial erosion or siltation.

The WQMP was designed specifically to preserve and protect the existing drainage patterns in the main stem of Gobernadora Creek and in side canyon tributaries. Specifically, WQMP facilities will be located to the extent feasible in the upper ends of the side canyons and will be operated to mimic the current conditions in the tributary channels. Drainage patterns will be altered within the development bubble where drainage infrastructure will be provided. However, drainage swales or other more natural drainage features will be utilized to the extent feasible.

Significance Threshold B: Substantially increase the frequencies and duration of channel adjusting flows.

Changes in the frequency and duration of flows were analyzed for each development bubble with the aid of the EPA SWMM Model. The combined control system for each development bubble was sized and configured to match, to the extent possible, the flow durations over the entire range of predicted flows, including the 2 and 10 year peak flows. A water balance also was conducted that took into account the effects of anticipated irrigation and the operation of the BMPs. The results of the water balance indicated that surface water runoff volume to Gobernadora Creek would effectively match the pre-developed condition.

On this basis, the effect of the proposed development in Cañada Gobernadora on altering existing drainage or increasing the frequency and duration of channel adjusting flows is determined to be less than significant.

#### 2. Decreased Infiltration and Groundwater Recharge

Significance Threshold A: Substantially deplete groundwater supplies or interfere substantially with groundwater recharge that would cause a net deficit in aquifer volumes or lowering of the local groundwater table.

The water balance indicates that infiltration volumes will likely increase by about 300 acre-ft/yr over pre-development conditions, and therefore groundwater levels, at least in the vicinity of the

proposed infiltration basins, would increase rather than decrease. On this basis, the impact of the proposed project on decreasing infiltration and groundwater recharge is considered less than significant.

However, groundwater levels are already high near the mouth of Cañada Gobernadora because of the apparent groundwater barrier. There is concern that these levels would prevent groundwater infiltration in these areas. Because of this concern, excess runoff volume would be discharged directly to San Juan Creek, or diverted to a non-domestic water supply reservoir for recycling or the nearby WWTP for reclamation.

On this basis, the potential effect of the proposed development on infiltration and groundwater recharge are considered less than significant.

### 3. Changed Base Flows

Significance Threshold A: Substantially increase or decrease base flows as to negatively impact riparian habitat.

The increase in infiltration and groundwater outflow leads to increases in base flows. As discussed above, the increase in base flows would be about 300 acre-ft/yr, which would constitute an increase of about 50 percent during dry years and about 20 percent during wet years. Analysis of vegetation in the GERA indicates that additional water could provide a benefit to improving the condition of riparian vegetation. The additional water could also possibly be used to increase the riparian habitat if the erosion effects caused by surface flows from existing upstream developed areas can be reduced by the Gobernadora Multi-purpose Basin (if constructed).

If increases in base flows were determined to be detrimental, the proposed Gobernadora Multi-purpose Basin also could be used to reduce base flow contributions from Coto de Caza to offset increases in lower Gobernadora associated with the proposed development. A second alternative, as discussed above, could involve routing excess flows directly to San Juan Creek thereby reducing or eliminating the need for infiltration, at least in those catchments in lower Gobernadora close to San Juan Creek. Excess base flows, especially between February and June, could improve breeding habitat for the arroyo toad and other sensitive aquatic species such as the southwestern pond turtle and arroyo chub.

Significance Threshold B: Substantially increase or decrease low flow estimates where high groundwater elevations are considered important.

To the extent that the projected increase in base flows enter San Juan Creek, the effect could potentially raise the groundwater elevations downstream, which would be beneficial to local and downstream aquatic habitats and potentially to downstream water supply pumping operations.

On this basis, the effect of the proposed development in altering base flows such as to adversely affect habitat or downstream groundwater levels for water supply purposes is considered less than significant.

### *Pollutants of Concern*

The following are the conclusions regarding the significance of impacts for the pollutants of concern under wet conditions.

*Sediments:* Mean total suspended solids concentrations are predicted to be less in the post-development condition than in the existing condition. Sources of coarse sediments generated within the sandy soils of the main valley will be protected, while the development location will potentially reduce the generation of fine sediment from tributary drainage characterized by clay soils. On this basis the impact of the B-4 alternative on suspended sediments is considered less than significant.

*Nutrients (Nitrogen and Phosphorous):* Given the geologic sources of phosphorus, the systems appear to be nitrogen limited and the more bioavailable form of nitrogen nutrient is nitrate-nitrogen. The concentration and load of nitrate-nitrogen is predicted to decrease with development and will be within the range of observed in-stream concentrations in Gobernadora Creek. Moreover, the combined control system includes facilities such as constructed wetlands, which have been shown to be effective in treating nutrients. On this basis, the impact of the B-4 alternative on nutrients is considered less than significant.

*Trace Metals:* Mean concentrations of total aluminum and dissolved cadmium, copper, lead, and zinc are predicted to increase relative to predicted concentrations under existing conditions. However, mean concentrations of aluminum, cadmium, copper, lead, and zinc are well below benchmark NAWQC and CTR criteria. On this basis, the impact of the B-4 alternative on trace metals is less than significant.

### ***Alternative B-9***

#### *Hydrologic Conditions of Concern and Significance Thresholds*

The following discusses the implications of the flow duration and water balance results on the hydrologic conditions of concern.

##### 1. Increased Stormwater Runoff Volume, Peak Discharges, and Flow Duration

Significance Threshold A. Substantially alter the existing drainage pattern of the site or area, including alteration of the course of a stream or river, in a manner that would cause substantial erosion or siltation.

The WQMP was designed specifically to preserve and protect the existing drainage patterns in the main stem of Gobernadora Creek and in the side canyon tributaries. Drainage patterns would

be altered within the development bubbles where drainage infrastructure will be provided. However, drainage swales or other more natural drainage features will be utilized to the extent feasible.

Significance Threshold B: Substantially increase the frequency and duration of channel adjusting flows.

Changes in the frequency and duration of channel adjusting flows would be effectively managed by incorporating flow duration controls in the design of the flow control and water quality basins. This design addresses a range of flows including the 2 and 10 year peak flow events required to be analyzed by the Local WQMP. Runoff from the 309 acre catchment just east of Chiquadora Ridge would be directed into San Juan Creek without flow duration control as San Juan Creek's size and infiltrative conditions are such that increased runoff from this size of catchment should not affect the stability of San Juan Creek.

## 2. Decreased Infiltration and Groundwater Recharge

Significance Threshold A: Substantially deplete groundwater supplies or interfere substantially with groundwater recharge that would cause a net deficit in aquifer volumes or lowering of the local groundwater table.

Excess runoff volume from the proposed development would be infiltrated, thereby increasing groundwater recharge and raising the local groundwater table, at least during the wet season. Potential increases in groundwater recharge into San Juan Creek could benefit downstream groundwater supplies.

## 3. Change in Base flows

Significance Criteria A: Substantially increase or decrease base flows as to negatively impact riparian habitat.

Base flows in Gobernadora Creek are likely to increase in response to the utilization of infiltration basins for capturing excess surface runoff. Current information suggests that the increase in base flows could provide needed water and improve the condition of the existing riparian vegetation in the GERA.

Significance Threshold B: Substantially increase or decrease low flow estimates where high groundwater elevations are considered important.

High groundwater elevations are important where groundwater is pumped for water supply. This is the case in lower San Juan Creek and the projected increase in base flows, although modest on the scale of the San Juan Creek watershed, could slightly improve groundwater levels. Based on the above considerations and conclusions, the impact of the B-9 alternative on hydrologic conditions of concern is considered less than significant.

### *Pollutants of Concern*

The following are the conclusions regarding the significance of impacts for the pollutants of concern under wet and dry weather conditions.

*Suspended Solids:* TSS concentrations and loads in runoff are projected to decrease under the B-9 alternative because of the effects of urban landscaping, impervious surfaces, and treatment achieved in the combined control system. In order to preserve the overall sediment supply to the streams, treatment will focus on urban runoff only and will bypass higher flows that may contain more coarse sediment. On this basis, the impact of the B-9 alternative on suspended solids is considered less than significant.

*Nutrients (Nitrogen and Phosphorus):* The concentrations and loads of the more biologically available form of nitrogen, namely nitrate-nitrogen, are not projected to increase. The increase in runoff total phosphorus concentrations are much less than observed in-stream concentrations, which suggests that the system is currently high in phosphorous and therefore more likely to be nitrogen limited. On this basis, the impact of the B-9 alternative on nutrients is considered less than significant.

*Trace Metals:* Mean concentrations and loads of trace metals are generally projected to increase with development, however in all cases, predicted mean concentrations are well below CTR and NAWQA acute aquatic criteria. On this basis, the impact of the B-9 alternative on trace metals is considered less than significant.

## **5.4 IMPACT ANALYSIS FOR THE CENTRAL SAN JUAN AND TRAMPAS SUB-BASIN**

This section evaluates the effectiveness of the WQMP for the Central San Juan and Trampas Sub-basin and evaluates the impacts of the proposed development on pollutants of concern and hydrologic conditions of concern.

A distinct feature in the Trampas Sub-basin is the existing Oglebay Norton sand mining and washing facilities that include an artificial lake that serves as a tailings reservoir, a desilting pond, and a temporary storage pond. This mining operation would be discontinued with the proposed project. The impact analysis considers conditions with and without the mine in the hydrologic modeling.

### **5.4.1 Impacts on Hydrologic Conditions of Concern**

#### ***Alternative B-4***

*Hydrologic Condition of Concern #1: Increased Stormwater Runoff Volume, Peak Discharge, and Flow Duration*

## Flow Duration Analysis

Although the flow duration analysis was conducted for each catchment affected by development, the results are presented here for one example. Figure 5-25 shows an example of the flow duration analysis for one of the two catchments that discharge into Trampas, and the estimated 2 and 10 year peak flows. In Trampas Canyon, the flow duration analysis used the pre-mine condition (the undeveloped condition) as the baseline for matching flow duration. The catchments in Trampas Canyon have very infiltrative soils and Figure 5-25 shows that predicted flows in the pre-mining condition were quite limited in magnitude and duration. Matching the pre-mine flow duration condition was reasonable for the more frequent flows, but difficult for infrequent higher flows. This example is provided to show one of the more difficult flow duration matching efforts.

## Water Balance Analysis

The water balance analysis for Central San Juan Sub-basin was conducted for each of the planning areas as follows:

- North Central San Juan (PA 3),
- East Central San Juan (PA 4),
- South Central San Juan/Trampas Canyon (PA 5)

Planning Area 5 in South Central San Juan was subdivided into two areas in order to isolate the effects of the proposed development on Trampas Creek. This subdivision of PA 5 also allowed the evaluation of the effects of the existing Oglebay Norton sand mining and washing facilities located in upper Trampas Canyon. Because this facility has such a major effect on hydrology in Trampas Canyon, the water balance was conducted with and without the facility.

The water balance results are presented as follows:

- All years - Tables 5-25 (with sand mine) and Table 5-26 (without sand mine)
- Dry years - Table 5-27 (with sand mine) and Table 5-28 (without sand mine)
- Wet Years - Table 5-29 (with sand mine) and Table 5-30 (without sand mine)

Note that because of the effects of grading, the pre- and post-development areas often change. Those changes are noted at the bottom of each table. Also note that the water balance results are provided in terms of inches of runoff and acre-ft of runoff. "Inches" as a volume is interpreted as equivalent to inches of water over the tributary drainage area. When there are large changes between the pre- and post-development tributary areas, the comparison using watershed-inches can be misleading and acre-ft should be used.

The following describes the water balance results by planning area.

*North Central San Juan (PA 3).* The proposed drainage infrastructure for North Central San Juan would result in a direct discharge to San Juan Creek. On average (based on all years), precipitation is about 15 inches per year and current irrigation, associated primarily with the 150 acres of irrigated nurseries, is estimated to increase the net applied water to about 17.1 inches per year. With development, the additional irrigation is estimated to increase the net applied water to about 23.6 inches per year for an increase of about 38 percent (Table 5-25). Runoff to San Juan Creek is projected to increase from about 228 acre-ft/yr to about 232 acre-ft/yr for an increase by about two percent. During dry years, the increase in runoff to San Juan Creek would be less than one percent (Table 5-27). In summary, the level of control provided by the combined control system in this planning area is such that changes in surface water hydrology are minimal.

*East Central San Juan (PA 4).* The proposed drainage infrastructure for East Central San Juan also would result in a direct discharge to San Juan Creek. On average (based on all years), precipitation is about 16 inches per year with only a small contribution from irrigation. There are approximately 15 acres of nurseries in this area. With development, the additional irrigation is estimated to increase the net applied water to about 17.0 inches per year for an increase of about six percent (Table 5-27). The relatively small increase in irrigation is because the planned development in PA 4 is low density estate residences. Runoff to San Juan Creek is projected to increase from about 268 acre-ft/yr to about 273 acre-ft/yr for an increase of about two percent. During dry years, the increase in runoff to San Juan Creek would be about six percent and the decrease in groundwater outflow would be about seven percent (Table 5-27). So during dry years, the effects on surface runoff are more pronounced. In summary, the level of development in this planning area is such that changes in surface water hydrology are quite modest.

*South Central San Juan/Trampas Canyon (PA5).* The proposed development in Trampas Canyon will eliminate the sand mining operation so the water balance analysis was conducted for the following two scenarios:

- Scenario 1: “With Mine Scenario” – Pre-development with mine, post-development without mine
  - All years - Table 5-25
  - Dry years - Table 5-27
  - Wet years - Table 5-29
- Scenario 2: “Without Mine Scenario” – Pre- and post-development without mine
  - All years - Table 5-26



- Dry years - Table 5-28
- Wet years - Table 5-30

The baseline condition is selected as the “with-mine” alternative consistent with the NCCP Guidelines that require flows to be maintained at levels comparable to existing conditions. For the “with-mine” condition, the water balance results indicate that surface runoff to San Juan Creek will increase from the present condition of about 12 acre-ft/yr to about 14 acre-ft/yr for an increase of about 14 percent (Table 5-25). During wet years, the surface runoff would be decreased from 29 acre-ft/yr under the existing condition to about 26 acre-ft/yr with the proposed development. This decrease of 3 acre-ft/yr is about a 10 percent reduction (Table 5-29). During dry years, there is very little runoff projected for either existing or proposed conditions (Table 5-27).

The proposed development in the remaining portion of PA 5 would discharge into an unnamed tributary west of Trampas Creek. The water balance for this area is given in the tables as South CSJ/PA5. For all years, the water balance indicates that the runoff to San Juan Creek would go from about 100 acre-ft/yr for the pre-developed condition to about 109 acre-ft/yr under post development, for an increase of about nine percent (Table 5-25). A similar percent increase is indicated for dry conditions. The higher pre-development runoff from this area (100 acre-ft/yr) compared to Trampas is caused by the presence of clay deposits, in contrast to the sandy conditions that prevail in the Trampas catchments.

#### *Hydrologic Condition of Concern #2: Decreased Infiltration and Groundwater Recharge*

*North Central San Juan (PA 3).* The water balance results for North Central San Juan indicate that for all years, groundwater infiltration would increase from about 937 acre-ft/yr to about 1,614 acre-ft/yr or by approximately 73 percent. For dry years, groundwater infiltration and outflow would increase from about 674 acre-ft/yr to about 1,333 acre-ft/yr or about 98 percent (Table 5-27). Thus, development is projected to increase infiltration and groundwater recharge and, similar to surface runoff, the effect is more pronounced during dry years.

*East Central San Juan (PA 4).* Infiltration in East Central San Juan is projected to decrease from about 972 acre-ft/yr to about 911 acre-ft/yr or approximately seven percent (Table 5-25). This decrease is associated in part with a projected increase in ET caused by the elimination of the nurseries. During dry weather conditions the decrease is about 52 acre-ft/yr or about seven percent (Table 5-27). These are fairly modest changes and would be more than compensated by increases in other planning areas tributary to San Juan Creek.

*South Central San Juan/Trampas Canyon (PA5).* In Trampas Canyon, the “with mine” water balance analysis indicates that infiltration and groundwater outflow would increase from 391 acre-ft/yr under the existing condition with the mine to about 1,085 acre-ft/yr with the proposed development (Table 5-25). This corresponds to an increase of about 700 acre-ft or about 180

percent. Thus the discontinuation of the mining operation is projected to increase groundwater infiltration and outflow to Trampas Creek.

### *Hydrologic Condition of Concern #3: Changed Base Flows*

*North Central San Juan (PA 3).* The water balance analysis discussed above indicates that post-development groundwater outflow will increase by about 677 acre-ft or 73 percent for all years (Table 5-25) and about 659 acre-ft (98 percent) during dry years (Table 5-27). This groundwater outflow would ultimately increase base flows in San Juan Creek, which would be utilized to support riparian vegetation, increase levels of the water table, or infiltrate into the channel bottom. Increased base flows in San Juan Creek will further support NCCP Guidelines recommendations addressing downstream aquatic habitat needs.

*East Central San Juan (PA 4).* Infiltration in East Central San Juan is projected to decrease about 61 acre-ft/yr or approximately seven percent for all years (Table 5-25) and about 52 acre-ft/yr (seven percent) during dry years (Table 5-27). These are fairly modest changes and would be more than compensated by increases in base flows from other planning areas tributary to San Juan Creek.

*South Central San Juan/Trampas Canyon (PA5).* In Trampas Canyon, the “with mine” water balance analysis indicates that groundwater outflow would increase approximately 700 acre-ft or 180 percent. Thus the discontinuation of the mining operation is projected to increase groundwater infiltration and outflow to Trampas Creek. This groundwater outflow would ultimately increase base flows in Trampas Creek, which would be utilized to support riparian vegetation, increase levels of the water table, or infiltrate into the channel bottom.

### ***Alternative B-9***

Figure 1-4 shows the proposed development areas under the B-9 alternative, which can be compared with the corresponding development areas under the B-4 alternative as shown in Figure 1-3. Table 4-13 lists the proposed land uses in the Central San Juan/Trampas Sub-basin under each alternative. As indicated in the table and figures, the proposed development in the Central San Juan and Trampas Sub-basin under the B-9 alternative would be about 3,213 acres versus 2,698 acres for the B-4 alternative. The increase in development area would be located in PA 4 in the eastern portion of the sub-basin. The proposed development area within PA 3 north of San Juan Creek would decrease slightly (by approximately 10 acres), while the proposed development area within Planning Area 5 south of San Juan Creek would not change in Alternative B-9. Therefore, the impact analysis presented above for the North Central San Juan (PA 3) catchments and the South Central San Juan (PA 5) catchments for Alternative B-4 applies to Alternative B-9. The impact analysis presented below pertains to the East Central San Juan (PA 4) catchments for the B-9 alternative.

**Table 5-25: Central San Juan & Trampas Sub-basin, With Sand Mine, Average Annual Water Balance, All Years (Alternative B-4) (inches (acre-ft))**

Tributary Area	Pre-Development								Post-Development with PDFs						
	INFLOW			OUTFLOW					INFLOW			OUTFLOW			
	Precipitation	Irrigation	Total	Quarry Runoff Recirculation	Surface Runoff to Creek	GW Outflow	ET	Total	Precipitation	Irrigation	Total	Surface Runoff to Creek	GW Outflow	ET	Total
Lake Area <sup>1</sup>	16.7 (585)	0.0 (0)	16.7 (585)	2.3 (81)	0.0 (0)	7.8 (274)	6.5 (229)	16.6 (583)	-	-	-	-	-	-	-
Trampas Creek/PA5 <sup>2</sup>	16.3 (883)	0.0 (0)	16.3 (883)	0.0 (0)	0.2 (12)	7.2 (391)	8.9 (480)	16.3 (883)	16.2 (1366)	7.7 (649)	23.9 (2015)	0.2 (14)	12.8 (1085)	10.8 (912)	23.8 (2010)
South CSJ/PA5 <sup>3</sup>	16.1 (798)	0.0 (0)	16.1 (798)	0.0 (0)	2.0 (100)	7.4 (368)	7.0 (350)	16.5 (818)	16.3 (1005)	6.4 (392)	22.6 (1397)	1.8 (109)	11.2 (694)	9.8 (602)	22.8 (1406)
North CSJ/PA3 <sup>4</sup>	15.0 (2005)	2.1 (284)	17.1 (2289)	0.0 (0)	1.7 (228)	7.0 (937)	8.7 (1164)	17.4 (2330)	15.4 (2177)	8.2 (1151)	23.6 (3328)	1.6 (232)	11.4 (1614)	10.6 (1492)	23.7 (3338)
East CSJ/PA4 <sup>5</sup>	15.8 (2028)	0.2 (28)	16.0 (2056)	0.0 (0)	2.1 (268)	7.6 (972)	6.7 (859)	16.4 (2099)	15.9 (1941)	1.2 (146)	17.0 (2087)	2.2 (273)	7.4 (911)	7.6 (934)	17.3 (2118)
<b>Total Sub-basin<sup>6</sup></b>	<b>15.7 (6299)</b>	<b>0.8 (312)</b>	<b>16.5 (6612)</b>	<b>2.3 (81)</b>	<b>1.7 (608)</b>	<b>7.3 (2941)</b>	<b>7.7 (3082)</b>	<b>16.7 (6713)</b>	<b>15.8 (6489)</b>	<b>5.7 (2338)</b>	<b>21.5 (8827)</b>	<b>1.5 (628)</b>	<b>10.5 (4304)</b>	<b>9.6 (3940)</b>	<b>21.7 (8872)</b>

<sup>1</sup>Pre-development sand mine area = 421 acres; post-development area = 0 acres.

<sup>2</sup>Pre-development tributary area (Trampas Creek) = 638 acres (excluding mine area); post-development tributary area = 1013 acres.

<sup>3</sup>Pre-development tributary area (South Central San Juan in Planning Area 5) = 597 acres (excluding quarry area); post-development tributary area = 735 acres.

<sup>4</sup>Pre-development tributary area (North Central San Juan in Planning Area 3) = 1605 acres; post-development tributary area = 1693 acres.

<sup>5</sup>Pre-development tributary area (East Central San Juan in Planning Area 4) = 1539 acres; post-development tributary area = 1470 acres.

<sup>6</sup>Pre-development tributary area (total Central San Juan and Trampas Sub-basin) = 4800 acres; post-development tributary area = 4911 acres.

**Table 5-26: Planning Area 5 in Central San Juan & Trampas Sub-basin, Without Sand Mine<sup>1</sup>, Average Annual Water Balance, All Years (Alternative B-4) (inches (acre-ft))**

Tributary Area	Pre-Development					Post-Development with PDFs						
	INFLOW	OUTFLOW				INFLOW			OUTFLOW			
	Precipitation	Surface Runoff to Creek	GW Outflow	ET	Total	Precipitation	Irrigation	Total	Surface Runoff to Creek	GW Outflow	ET	Total
Trampas Creek/PA5 <sup>2</sup>	16.4 (1452)	0.2 (19)	7.4 (656)	8.8 (775)	16.4 (1450)	16.2 (1366)	7.7 (649)	23.9 (2015)	0.2 (14)	12.8 (1085)	10.8 (912)	23.8 (2010)
South CSJ/PA5 <sup>3</sup>	16.1 (798)	2.0 (100)	7.4 (368)	7.0 (350)	16.5 (818)	16.3 (996)	6.1 (371)	22.3 (1367)	1.9 (115)	11.1 (681)	9.5 (580)	22.5 (1376)

<sup>1</sup>Results are shown for Planning Area 5 with the pre-development condition, before the mine, represented as open space.

<sup>2</sup>Pre-development, pre-mine tributary area (Trampas Creek) = 1059 acres; post-development tributary area = 1,013 acres.

<sup>3</sup>Pre-development, pre-mine tributary area (South Central San Juan in Planning Area 5) = 596 acres; post-development tributary area = 735 acres.

**Table 5-27: Central San Juan & Trampas Sub-basin, With Sand Mine, Average Annual Water Balance, Dry Years (Alternative B-4) (inches (acre-ft))**

Tributary Area	Pre-Development								Post-Development with PDFs							
	INFLOW			OUTFLOW					INFLOW			OUTFLOW				
	Precipitation	Irrigation	Total	Quarry Runoff Recirculation	Surface Runoff to Creek	GW Outflow	ET	Total	Precipitation	Irrigation	Total	Surface Runoff to Creek	GW Outflow	ET	Total	
Lake Area <sup>1</sup>	14.0 (490)	0.0 (0)	14.0 (490)	1.8 (64)	0.0 (0)	5.5 (193)	6.6 (233)	14.0 (490)	-	-	-	-	-	-	-	
Trampas Creek/PA5 <sup>2</sup>	13.7 (740)	0.0 (0)	13.7 (740)	0.0 (0)	0.1 (4)	4.6 (251)	9.1 (491)	13.8 (745)	13.6 (1145)	7.7 (648)	21.2 (1792)	0.1 (8)	10.3 (867)	10.8 (912)	21.2 (1787)	
South CSJ/PA5 <sup>3</sup>	13.5 (669)	0.0 (0)	13.5 (669)	0.0 (0)	1.2 (61)	5.5 (273)	7.2 (357)	13.9 (691)	13.7 (843)	6.3 (392)	20.0 (1235)	1.1 (66)	9.2 (571)	9.8 (605)	20.1 (1242)	
North CSJ/PA3 <sup>4</sup>	12.6 (1679)	2.1 (284)	14.7 (1963)	0.0 (0)	1.1 (148)	5.0 (674)	8.8 (1182)	15.0 (2005)	12.9 (1823)	8.2 (1150)	21.1 (2973)	1.1 (149)	9.5 (1333)	10.6 (1490)	21.1 (2973)	
East CSJ/PA4 <sup>5</sup>	13.3 (1699)	0.2 (28)	13.5 (1727)	0.0 (0)	1.4 (178)	5.6 (718)	6.8 (873)	13.8 (1769)	13.3 (1626)	1.2 (146)	14.5 (1772)	1.5 (188)	5.4 (666)	7.7 (948)	14.7 (1803)	
<b>Total Sub-basin<sup>6</sup></b>	<b>13.2 (5277)</b>	<b>0.8 (312)</b>	<b>13.9 (5589)</b>	<b>1.8 (64)</b>	<b>1.1 (391)</b>	<b>5.3 (2109)</b>	<b>7.8 (3136)</b>	<b>14.2 (5700)</b>	<b>13.3 (5437)</b>	<b>5.7 (2336)</b>	<b>19.0 (7773)</b>	<b>1.0 (412)</b>	<b>8.4 (3437)</b>	<b>9.7 (3956)</b>	<b>19.0 (7804)</b>	

<sup>1</sup>Pre-development with sand mine area = 421 acres; post-development sand mine area = 0 acres.

<sup>2</sup>Pre-development tributary area (Trampas Creek) = 638 acres (excluding mine area); post-development tributary area = 1013 acres.

<sup>3</sup>Pre-development tributary area (South Central San Juan in Planning Area 5) = 597 acres (excluding quarry area); post-development tributary area = 735 acres.

<sup>4</sup>Pre-development tributary area (North Central San Juan in Planning Area 3) = 1605 acres; post-development tributary area = 1693 acres.

<sup>5</sup>Pre-development tributary area (East Central San Juan in Planning Area 4) = 1539 acres; post-development tributary area = 1470 acres.

<sup>6</sup>Pre-development tributary area (total Central San Juan and Trampas Sub-basin) = 4800 acres; post-development tributary area = 4911 acres.

**Table 5-28: Planning Area 5 in Central San Juan & Trampas Sub-basin, Without Sand Mine<sup>1</sup>, Average Annual Water Balance, Dry Years (Alternative B-4) (inches (acre-ft))**

Tributary Area	Pre-Development					Post-Development with PDFs							
	INFLOW	OUTFLOW				INFLOW			OUTFLOW				
	Precipitation	Surface Runoff to Creek	GW Outflow	ET	Total	Precipitation	Irrigation	Total	Surface Runoff to Creek	GW Outflow	ET	Total	
Trampas Creek/PA5 <sup>2</sup>	13.8 (1216)	0.1 (6)	4.8 (425)	9.0 (792)	13.9 (1223)	13.6 (1145)	7.7 (648)	21.2 (1792)	0.1 (8)	10.3 (867)	10.8 (912)	21.2 (1787)	
South CSJ/PA5 <sup>3</sup>	13.5 (669)	1.2 (61)	5.5 (273)	7.2 (357)	13.9 (691)	13.7 (836)	6.0 (370)	19.7 (1206)	1.2 (70)	9.2 (561)	9.5 (582)	19.8 (1213)	

<sup>1</sup>Results are shown for Planning Area 5 with the pre-development condition, before the mine, represented as open space.

<sup>2</sup>Pre-development, pre-mine tributary area (Trampas Creek) = 1059 acres; post-development tributary area = 1,013 acres.

<sup>3</sup>Pre-development, pre-mine tributary area (South Central San Juan in Planning Area 5) = 596 acres; post-development tributary area = 735 acres.

**Table 5-29: South Central San Juan (PA5) & Trampas Tributary Areas, With Mine, Average Annual Water Balance, Wet Years (inches (Alternative B-4) (acre-ft))**

Tributary Area	Pre-Development			Post-Development with PDFs											
	INFLOW			OUTFLOW					INFLOW			OUTFLOW			
	Precipitation	Irrigation	Total	Quarry Runoff Recirculation	Surface Runoff to Creek	GW Outflow	ET	Total	Precipitation	Irrigation	Total	Surface Runoff to Creek	GW Outflow	ET	Total
Quarry Area <sup>1</sup>	22.4 (786)	0.0 (0)	22.4 (786)	3.3 (116)	0.0 (0)	12.7 (444)	6.3 (220)	22.2 (781)	-	-	-	-	-	-	-
Trampas Creek/PA5 <sup>2</sup>	21.9 (1187)	0.0 (0)	21.9 (1187)	0.0 (0)	0.5 (29)	12.7 (687)	8.5 (459)	21.7 (1174)	21.7 (1835)	7.7 (650)	29.4 (2486)	0.3 (26)	18.3 (1546)	10.8 (911)	29.4 (2483)
South CSJ/PA5 <sup>3</sup>	21.6 (1073)	0.0 (0)	21.6 (1073)	0.0 (0)	3.7 (184)	11.4 (568)	6.7 (335)	21.9 (1087)	21.8 (1347)	6.4 (393)	28.2 (1740)	3.3 (201)	15.5 (955)	9.7 (597)	28.4 (1753)
North CSJ/PA3 <sup>4</sup>	20.1 (2695)	2.1 (285)	22.3 (2979)	0.0 (0)	3.0 (397)	11.2 (1494)	8.4 (1126)	22.6 (3018)	20.7 (2925)	8.2 (1154)	28.9 (4079)	2.9 (407)	15.7 (2210)	10.6 (1496)	29.2 (4113)
East CSJ/PA4 <sup>5</sup>	21.3 (2725)	0.2 (28)	21.5 (2753)	0.0 (0)	3.6 (459)	11.8 (1509)	6.5 (829)	21.8 (2798)	21.3 (2609)	1.2 (146)	22.5 (2755)	3.7 (452)	11.7 (1429)	7.4 (904)	22.7 (2785)
Total Sub-basin <sup>6</sup>	21.1 (8465)	0.8 (313)	21.9 (8778)	3.3 (116)	2.9 (1068)	11.7 (4703)	7.4 (2969)	22.1 (8858)	21.3 (8716)	5.7 (2344)	27.0 (11059)	2.7 (1086)	15.0 (6140)	9.5 (3908)	27.2 (11134)

<sup>1</sup>Pre-development mine area = 421 acres; post-development mine area = 0 acres.

<sup>2</sup>Pre-development tributary area (Trampas Creek) = 638 acres (excluding mine area); post-development tributary area = 1013 acres.

<sup>3</sup>Pre-development tributary area (South Central San Juan in Planning Area 5) = 597 acres (excluding quarry area); post-development tributary area = 735 acres.

<sup>4</sup>Pre-development tributary area (North Central San Juan in Planning Area 3) = 1605 acres; post-development tributary area = 1693 acres.

<sup>5</sup>Pre-development tributary area (East Central San Juan in Planning Area 4) = 1539 acres; post-development tributary area = 1470 acres.

<sup>6</sup>Pre-development tributary area (total Central San Juan and Trampas Sub-basin) = 4800 acres; post-development tributary area = 4911 acres.

**Table 5-30: Planning Area 5 in Central San Juan & Trampas Sub-basin, Pre-Mine<sup>1</sup>, Average Annual Water Balance, Wet Years (inches (Alternative B-4) (acre-ft))**

Tributary Area	Pre-Development					Post-Development with PDFs							
	INFLOW	OUTFLOW				INFLOW			OUTFLOW				
	Precipitation	Surface Runoff to Creek	GW Outflow	ET	Total	Precipitation	Irrigation	Total	Surface Runoff to Creek	GW Outflow	ET	Total	
Trampas Creek/PA5 <sup>2</sup>	22.1 (1950)	0.5 (45)	13.0 (1146)	8.4 (739)	21.9 (1930)	21.7 (1835)	7.7 (650)	29.4 (2486)	0.3 (26)	18.3 (1546)	10.8 (911)	29.4 (2483)	
South CSJ/PA5 <sup>3</sup>	21.6 (1073)	3.7 (184)	11.4 (568)	6.7 (335)	21.9 (1087)	21.8 (1335)	6.1 (371)	27.9 (1707)	3.4 (210)	15.3 (936)	9.4 (575)	28.1 (1720)	

<sup>1</sup>Results are shown for Planning Area 5 with the pre-development condition, before the mine, represented as open space.

<sup>2</sup>Pre-development, pre-mine tributary area (Trampas Creek) = 1059 acres; post-development tributary area = 1,013 acres.

<sup>3</sup>Pre-development, pre-mine tributary area (South Central San Juan in Planning Area 5) = 596 acres; post-development tributary area = 735 acres.

*Hydrologic Condition of Concern #1: Increased Stormwater Runoff Volume, Peak Discharge, and Flow Duration*

Flow Duration Analysis

The flow duration analysis was conducted for each catchment affected by proposed development. The flow duration analysis results were used to select and size the combined control system facilities (see Section 4.4.4). The proposed control facilities achieve good flow duration matching over the entire range of flows, including the 2 and 10 year peak flows.

Water Balance Analysis

The water balance analysis was conducted for the East Central San Juan (PA 4) catchments. The water balance results are presented in Table 5-31. On average (based on all years), precipitation is about 16 inches per year with only a small contribution from irrigation. There are approximately 15 acres of nurseries in this area. With development, the additional irrigation is estimated to increase the net applied water to about 28.4 inches per year for an increase of about 1,326 acre-ft/yr or 65 percent (Table 5-31). In all years, runoff to San Juan Creek is projected to increase from about 268 acre-ft/yr to about 279 acre-ft/yr for an increase of about four percent. During dry years, runoff to San Juan Creek would increase from 178 acre-ft/yr to 186 acre-ft/yr, for an increase of approximately five percent. In summary, the effect of the combined control system is such that changes in surface water hydrology are quite modest.

*Hydrologic Condition of Concern #2: Decreased Infiltration and Groundwater Recharge*

Infiltration in East Central San Juan is projected to increase from about 972 acre-ft/yr to about 1,905 acre-ft/yr or approximately 96 percent in all years (Table 5-31). This increase is associated in part with the 65 percent increase in net applied water. During dry weather conditions, the increase is about 958 acre-ft/yr or about 133 percent.

*Hydrologic Condition of Concern #3: Changed Base Flows*

Infiltration in East Central San Juan is projected to increase about 933 acre-ft/yr or approximately 96 percent for all years (Table 5-31) and about 958 acre-ft/yr (135 percent) during dry years.

**Table 5-31: East Central San Juan (PA 4) Average Annual Water Balance (Alternative B-9) (inches (acre-ft))**

Climatic Condition				Pre-Development <sup>1</sup>					Post-Development with PDFs <sup>1</sup>						
	INFLOW			OUTFLOW					INFLOW			OUTFLOW			
	Precipitation	Irrigation	Total	Quarry Runoff Recirculation	Surface Runoff to Creek	GW Outflow	ET	Total	Precipitation	Irrigation	Total	Surface Runoff to Creek	GW Outflow	ET	Total
All Years	15.8 (2028)	0.2 (28)	16.0 (2056)	0.0 (0)	2.1 (268)	7.6 (972)	6.7 (859)	16.4 (2099)	16.1 (1913)	12.4 (1469)	28.4 (3382)	2.3 (279)	16.0 (1905)	11.0 (1311)	29.4 (3495)
Dry Years	13.3 (1699)	0.2 (28)	13.5 (1727)	0.0 (0)	1.4 (178)	5.6 (718)	6.8 (873)	13.8 (1769)	13.5 (1602)	12.3 (1468)	25.8 (3070)	1.6 (186)	14.1 (1676)	11.1 (1317)	26.7 (3179)
Wet Years	21.3 (2725)	0.2 (28)	21.5 (2753)	0.0 (0)	3.6 (459)	11.8 (1509)	6.5 (829)	21.8 (2798)	21.6 (2570)	12.4 (1473)	34.0 (4042)	4.0 (476)	20.1 (2390)	10.9 (1297)	35.0 (4163)

<sup>1</sup>Pre-development tributary area (South Central San Juan in Planning Area 4) = 1539 acres; post-development tributary area = 1427 acres.

#### 5.4.2 Impacts on Pollutants of Concern – Alternative B-4

The section presents the water quality modeling results used to address impacts of stormwater runoff on sediments, nutrients, and trace metals for Alternative B-4. For this sub-basin, the mean annual loads and mean annual concentrations are provided separately for each planning area and, in PA5, also distinguish between Trampas Canyon and the unnamed tributary west of Trampas. The water quality analysis for PA5 includes, as part of the pre-development condition, the Trampas Canyon sand mining operation.

##### *TSS Loads and Concentrations*

Table 5-32 summarizes TSS loads and concentrations and shows the percent change associated with the proposed development for each planning area and the total sub-basin area. Considering all three planning areas, TSS loads are predicted to decrease by about 35 percent and TSS concentrations are predicted to decrease by about 35 to 42 percent. Pre-development loads in Trampas Canyon are low because of the sediment trapping associated with the Trampas Canyon mining operation. Table 5-33 shows that the predicted post-development runoff TSS concentration is approximately 164 mg/L, which is much lower than in-stream data collected by Wildermuth in the San Juan watershed.

**Table 5-32: Predicted Average Annual TSS Loads and Concentrations for the Central San Juan and Trampas Sub-basin (Alternative B-4)**

Modeled Area	Site Condition	TSS Load (metric tons)			TSS Concentration (mg/L)		
		All Years	Dry Years	Wet Years	All Years	Dry Years	Wet Years
South CSJ/PA5	Pre-Developed	24	14	46	198	189	205
	Developed	55	39	88	140	128	152
	Dev w/ PDFs	24	14	45	171	168	174
	Percent Change	-1	2	-3	-14	-11	-15
Trampas Creek/PA5	Pre-Developed <sup>1</sup>	3	1	7	200	165	211
	Developed	60	49	82	117	116	118
	Dev w/ PDFs	2	1	4	123	130	119
	Percent Change	-29	54	-47	-39	-21	-44
North CSJ/PA3	Pre-Developed	96	69	154	342	376	315
	Developed	106	83	154	118	116	122
	Dev w/ PDFs	36	22	66	126	118	131
	Percent Change	-63	-68	-57	-63	-69	-58
East CSJ/PA4	Pre-Developed	71	47	122	215	212	216
	Developed	66	46	110	179	175	183
	Dev w/ PDFs	63	43	105	187	185	189
	Percent Change	-11	-8	-14	-13	-13	-13



Modeled Area	Site Condition	TSS Load (metric tons)			TSS Concentration (mg/L)		
		All Years	Dry Years	Wet Years	All Years	Dry Years	Wet Years
Total Sub-basin Area	Pre-Developed	194	130	330	259	270	251
	Developed	287	217	434	132	127	138
	Dev w/ PDFs	125	80	221	161	157	164
	Percent Change	-35	-38	-33	-38	-42	-35

<sup>1</sup>This condition reflects sand mining and processing operation including Trampas Dam and a large quarry pit which limits runoff to Trampas Creek.

**Table 5-33: Comparison of Predicted TSS Concentration with Water Quality Objectives and Observed In-Stream Concentrations for the Central San Juan and Trampas Sub-basin (Alternative B-4)**

Predicted Average Annual TSS Concentration <sup>1</sup> (mg/L)	San Diego Basin Plan Water Quality Objectives	Range of Observed In-stream Concentrations <sup>2</sup> (mg/L)
164	TSS levels shall not cause a nuisance or adversely affect beneficial uses as a result of controllable water quality factors	None Detected – 3,100

<sup>1</sup>Modeled concentration for total sub-basin area developed conditions with PDFs in wet years.

<sup>2</sup>Range of means observed at four San Juan watershed stations during the wet years.

NA – not applicable

### *Nutrient Loads and Concentrations*

Table 5-34 summarizes nutrient loads and shows percent changes for all years, dry years, and wet years respectively, for each planning area. This and other tables showing nutrients include the approximately 150 acres of nurseries in PA 3 and approximately 15 acres of nurseries in PA 4. For all three planning areas, the net change in loads for nitrate nitrogen is projected to decrease by about 41 percent whereas TKN loads are projected to increase by approximately 35 percent. Nitrate-nitrogen is inorganic nitrogen and is considered more bio-available than TKN, which contains both organic and inorganic forms of nitrogen. Projected loads are generally the largest during wet years and the lowest during dry years. Load increases dramatically in the Trampas Canyon portion of PA 5 in the post-developed case because the effect of the mine is removed. Much of this runoff is then infiltrated in the post-development with PDF case, causing a substantial reduction in loads entering Trampas Creek. Table 5-34 shows that total phosphorus loads are predicted to decrease slightly in all years and by approximately 12 percent in dry years, and is predicted to increase by 9 percent in wet years. The major source of phosphorous is PA3.

Table 5-35 summarizes nutrient concentrations. The concentrations of nitrate-nitrogen are projected to decrease by about 38 to 48 percent, whereas TKN concentrations are projected to increase by about 20 to 39 percent. Total phosphorous concentrations are projected to decrease by as much as 17 percent during dry years and increase by about six percent during wet years.

Table 5-36 compares the predicted average annual runoff concentrations of nutrients with observed in-stream data from Wildermuth. The water quality impact of concern here is excessive algal growth. The Basin Plan narrative objective is “Concentrations of nitrogen and phosphorous, by themselves or in combination with other nutrients, shall be maintained at levels below those which stimulate algae and emergent plant growth.” The results in the table indicate the predicted post-development runoff concentration for total phosphorous is less than that observed, where the observed data reflects the contribution from open areas and existing land uses. The higher observed nutrient data is consistent with the geologic information that indicates underlying bedrock may contribute high levels of phosphorous from open areas. Nitrate-nitrogen concentrations tend to be in the lower range of the observed data, and this is important, as mentioned above, as nitrate-nitrogen is more bioavailable than TKN. These projections would indicate that projected nutrient concentrations in runoff are comparable to or less than in-stream observations and therefore should not result in an increase in algae growth.

**Table 5-34: Predicted Average Annual Nutrient Loads for the Central San Juan and Trampas Sub-basin (Alternative B-4) (lbs)**

Modeled Area	Site Condition	Nitrate-N Loads			TKN Loads			Total P Loads		
		All Years	Dry Years	Wet Years	All Years	Dry Years	Wet Years	All Years	Dry Years	Wet Years
South CSJ/PA5	Pre-Developed	286	167	538	269	164	491	40	26	70
	Developed	738	547	1141	2013	1701	2675	283	240	375
	Dev w/ PDFs	300	180	555	541	333	983	76	47	136
	Percent Change	5	8	3	101	103	100	88	81	94
Trampas Creek	Pre-Developed <sup>1</sup>	33	9	84	31	10	75	5	2	10
	Developed	871	717	1197	3228	2686	4377	448	373	607
	Dev w/ PDFs	25	17	44	48	53	37	6	7	5
	Percent Change	-24	78	-48	55	414	-50	42	298	-55
North CSJ/PA3	Pre-Developed	1495	1114	2300	1374	1033	2094	304	239	440
	Developed	1536	1219	2207	5579	4553	7753	775	633	1075
	Dev w/ PDFs	508	317	914	1715	1159	2892	237	161	399
	Percent Change	-66	-72	-60	25	12	38	-22	-33	-9

Modeled Area	Site Condition	Nitrate-N Loads			TKN Loads			Total P Loads		
		All Years	Dry Years	Wet Years	All Years	Dry Years	Wet Years	All Years	Dry Years	Wet Years
East CSJ/PA4	Pre-Developed	870	581	1481	791	539	1326	124	88	201
	Developed	805	560	1323	1190	851	1908	171	124	270
	Dev w/ PDFs	752	513	1257	992	676	1661	142	98	234
	Percent Change	-14	-12	-15	25	25	25	14	11	17
Total Sub-basin Area	Pre-Developed	2683	1871	4403	2465	1746	3986	473	355	722
	Developed	3950	3044	5868	12011	9790	16713	1676	1369	2327
	Dev w/ PDFs	1594	1026	2796	3327	2220	5671	465	313	788
	Percent Change	-41	-45	-36	35	27	42	-2	-12	9

<sup>1</sup>This condition reflects sand mining and processing operation including Trampas Dam and a large quarry pit which limits runoff to Trampas Creek.

**Table 5-35: Predicted Average Annual Nutrient Concentrations for the Central San Juan and Trampas Sub-basin (Alternative B-4) (mg/L)**

Modeled Area	Site Condition	Nitrate-N Concentration			TKN Concentration			Total P Concentration		
		All Years	Dry Years	Wet Years	All Years	Dry Years	Wet Years	All Years	Dry Years	Wet Years
South CSJ/PA5	Pre-Developed	1.0	1.0	1.1	1.0	1.0	1.0	0.1	0.2	0.1
	Developed	0.8	0.8	0.9	2.3	2.5	2.1	0.3	0.4	0.3
	Dev w/ PDFs	1.0	0.9	1.0	1.7	1.8	1.7	0.2	0.2	0.2
	Percent Change	-8	-6	-10	76	77	75	64	58	69
Trampas Creek	Pre-Developed <sup>1</sup>	1.1	0.9	1.1	1.0	1.0	1.0	0.1	0.2	0.1
	Developed	0.8	0.8	0.8	2.9	2.9	2.8	0.4	0.4	0.4
	Dev w/ PDFs	0.7	0.8	0.6	1.3	2.6	0.5	0.2	0.4	0.1
	Percent Change	-34	-8	-44	33	164	-47	22	105	-52
North CSJ/PA3	Pre-Developed	2.4	2.8	2.1	2.2	2.6	1.9	0.5	0.6	0.4
	Developed	0.8	0.8	0.8	2.8	2.9	2.8	0.4	0.4	0.4
	Dev w/ PDFs	0.8	0.8	0.8	2.7	2.9	2.6	0.4	0.4	0.4
	Percent Change	-67	-72	-61	23	11	35	-23	-33	-11
East CSJ/PA4	Pre-Developed	1.19	1.20	1.19	1.09	1.11	1.06	0.17	0.18	0.16
	Developed	0.98	0.97	1.00	1.45	1.47	1.44	0.21	0.21	0.20
	Dev w/ PDFs	1.01	1.00	1.02	1.34	1.32	1.35	0.19	0.19	0.19
	Percent Change	-15	-17	-14	23	19	27	12	5	18

Modeled Area	Site Condition	Nitrate-N Concentration			TKN Concentration			Total P Concentration		
		All Years	Dry Years	Wet Years	All Years	Dry Years	Wet Years	All Years	Dry Years	Wet Years
Total Sub-basin Area	Pre-Developed	1.62	1.76	1.52	1.49	1.64	1.37	0.29	0.33	0.25
	Developed	0.83	0.81	0.85	2.51	2.60	2.41	0.35	0.36	0.34
	Dev w/ PDFs	0.93	0.91	0.94	1.93	1.97	1.90	0.27	0.28	0.26
	Percent Change	-43	-48	-38	30	20	39	-6	-17	6

<sup>1</sup>This condition reflects sand mining and processing operation including Trampas Dam and a large quarry pit which limits runoff to Trampas Creek.

**Table 5-36: Comparison of Predicted Nutrient Concentrations with Observed In-Stream Concentrations for the Central San Juan and Trampas Sub-basin (Alternative B-4)**

Nutrient	Predicted Average Annual Concentration <sup>1</sup> (mg/L)			Observed Range of In-Stream Concentrations <sup>2</sup> (mg/L)
	All Years	Dry Years	Wet Years	
Nitrate	0.93	0.91	0.94	0.15 – 1.5
TKN	1.93	1.97	1.90	None Detected – 3.0
Total Phosphorus	0.27	0.28	0.26	None Detected – 2.8

<sup>1</sup>Modeled concentration for total sub-basin area developed conditions with PDFs.

<sup>2</sup>Range of means observed at four San Juan watershed stations during the wet years.

NA – not applicable

### **Trace Metals**

Table 5-37 shows the predicted mean annual loads for aluminum, cadmium, copper, lead, and zinc for the three development scenarios and for the three climatic conditions. Except for aluminum, the concentrations are all in the dissolved form, which is the form addressed in the California Toxics Rule. Overall for all 3 planning areas, the aluminum, cadmium, and zinc loads are projected to decrease slightly, while copper and lead loads are predicted to increase between 14 and 35 percent for all years. In general, loads are higher in wet years and lower during dry years, and are higher from PA 3 which is the largest of the three planning areas. The highest loads are associated with aluminum, then in descending order zinc, copper, lead, and cadmium.

Table 5-38 presents the predicted runoff trace metal concentrations. Overall, concentrations tend to decrease by about six percent for aluminum, about six to 13 percent for cadmium, and about five percent for zinc. Concentrations of dissolved copper are predicted to increase by about two to 16 percent depending on the climatic condition. Dissolved lead is predicted to increase by

about 29 percent in all years. These concentration changes reflect changes associated with urbanization, the effects of bypassing higher flows around the water quality control facilities, and contributions from untreated open areas.

Table 5-39 compares the predicted mean annual concentrations with CTR criteria and observed in stream data. The CTR criteria apply to acute aquatic toxicity and assume a hardness of 120 mg/L, which was the minimum observed hardness. As criteria increase with hardness, applying the minimum observed hardness is conservative, that is, would result in the minimum criteria. The table indicates that the projected mean runoff concentrations are well below the CTR criteria. The predicted runoff values tend to be higher than the observed in-stream data and this may reflect the fact that we are comparing dissolved forms. The partitioning between dissolved and particulate forms of metals is influenced by the availability of solids and the organic content of the solids. Where solids concentrations are high, such as in the streams, partitioning will tend to reduce the dissolved fraction, and where solids concentrations tend to be low, such as in the runoff, partitioning will tend to increase the dissolved fraction. Consequently the low observed dissolved concentration in the stream may be a consequence of the higher TSS values in the stream.

**Table 5-37: Predicted Average Annual Trace Metal Loads for the Central San Juan and Trampas Sub-basin (Alternative B-4) (lbs)**

Modeled Area	Site Condition	Total Aluminum			Dissolved Cadmium			Dissolved Copper			Dissolved Lead			Dissolved Zinc		
		All Years	Dry Years	Wet Years	All Years	Dry Years	Wet Years	All Years	Dry Years	Wet Years	All Years	Dry Years	Wet Years	All Years	Dry Years	Wet Years
South CSJ/PA5	Pre-Developed	169	99	317	0.2	0.1	0.3	2.1	1.4	3.5	0.3	0.2	0.6	13	9	23
	Developed	497	378	748	0.5	0.4	0.8	8.3	6.9	11.4	3.3	2.8	4.3	35	27	51
	Dev w/ PDFs	189	114	349	0.2	0.1	0.3	2.5	1.6	4.5	0.8	0.5	1.5	13	8	23
	Percent Change	12	15	10	-1	-8	5	21	11	30	164	175	156	-5	-11	0
Trampas Creek	Pre-Developed <sup>1</sup>	20	6	50	0.02	0.01	0.05	0.2	0.1	0.5	0.04	0.01	0.09	2	1	3
	Developed	626	517	858	0.64	0.53	0.88	11.5	9.5	15.6	5.46	4.55	7.40	40	33	55
	Dev w/ PDFs	16	12	26	0.01	0.01	0.02	0.2	0.2	0.2	0.08	0.09	0.05	1	1	1
	Percent Change	-18	105	-48	-36	13	-59	-19	66	-61	107	745	-48	-39	4	-58
North CSJ/PA3	Pre-Developed	394	251	698	0.41	0.29	0.68	5.4	3.9	8.5	2.5	2.0	3.7	22	14	39
	Developed	1098	878	1566	1.13	0.91	1.59	20.0	16.3	27.8	9.4	7.7	13.1	71	57	100
	Dev w/ PDFs	357	227	634	0.36	0.23	0.62	6.1	4.1	10.5	2.9	2.0	4.8	22	14	39
	Percent Change	-9	-10	-9	-14	-20	-9	13	4	23	15	0	31	1	1	2
East CSJ/PA4	Pre-Developed	460	299	800	0.48	0.33	0.77	5.2	3.7	8.4	1.0	0.7	1.7	33	23	55
	Developed	496	347	813	0.54	0.40	0.84	6.7	5.0	10.3	1.7	1.2	2.7	37	27	58
	Dev w/ PDFs	457	312	765	0.48	0.34	0.77	5.8	4.1	9.2	1.4	0.9	2.3	33	24	54
	Percent Change	0	4	-4	1	3	-1	10	11	10	36	34	37	0	3	-2
Total Sub-basin Area	Pre-Developed	1043	655	1864	1.1	0.8	1.8	13.0	9.2	20.9	3.9	2.8	6.1	70	47	120
	Developed	2717	2119	3984	2.9	2.3	4.1	46.4	37.6	65.1	19.8	16.3	27.5	183	144	264
	Dev w/ PDFs	1026	665	1792	1.0	0.7	1.8	14.7	10.0	24.7	5.2	3.5	8.9	70	47	119
	Percent Change	-2	1	-4	-5	-7	-3	14	8	19	35	23	46	-1	0	-1

<sup>1</sup>This condition reflects sand mining and processing operation including Trampas Dam and a large quarry pit which limits runoff to Trampas Creek.

**Table 5-38: Predicted Average Annual Trace Metal Concentrations for the Central San Juan and Trampas Sub-basin (Alternative B-4) (µg/L)**

Model Area	Site Condition	Total Aluminum			Dissolved Cadmium			Dissolved Copper			Dissolved Lead			Dissolved Zinc		
		All Years	Dry Years	Wet Years	All Years	Dry Years	Wet Years	All Years	Dry Years	Wet Years	All Years	Dry Years	Wet Years	All Years	Dry Years	Wet Years
South CSJ/PA5	Pre-Developed	620	598	635	0.7	0.8	0.6	8	9	7	1.1	1.1	1.2	49	54	46
	Developed	572	559	586	0.6	0.6	0.6	10	10	9	3.8	4.1	3.3	40	40	40
	Dev w/ PDFs	607	601	612	0.6	0.6	0.6	8	8	8	2.7	2.7	2.6	41	42	40
	Percent Change	-2	0	-4	-13	-19	-8	6	-3	13	131	141	124	-17	-22	-13
Trampas Creek	Pre-Developed <sup>1</sup>	625	543	648	0.7	1.0	0.6	7	11	6	1.2	1.0	1.2	48	66	43
	Developed	556	555	558	0.6	0.6	0.6	10	10	10	4.9	4.9	4.8	35	35	35
	Dev w/ PDFs	439	573	360	0.4	0.6	0.3	5	9	3	2.1	4.4	0.7	25	35	19
	Percent Change	-30	5	-44	-45	-42	-56	-30	-15	-58	78	334	-45	-48	-47	-55
North CSJ/PA3	Pre-Developed	636	624	646	0.67	0.71	0.63	8.7	9.8	7.9	4.05	4.85	3.43	35.6	35.3	35.9
	Developed	557	554	561	0.57	0.58	0.57	10.1	10.3	10.0	4.78	4.86	4.68	35.8	35.8	35.7
	Dev w/ PDFs	566	558	573	0.56	0.57	0.56	9.7	10.1	9.5	4.57	4.82	4.37	35.4	35.3	35.6
	Percent Change	-11	-11	-11	-15	-21	-11	11	3	20	13	0	28	0	0	-1
East CSJ/PA4	Pre-Developed	631	618	641	0.65	0.69	0.62	7.15	7.70	6.70	1.39	1.43	1.36	45.8	48.1	43.9
	Developed	606	597	615	0.66	0.69	0.63	8.18	8.58	7.80	2.08	2.08	2.07	45.4	47.2	43.8
	Dev w/ PDFs	616	610	622	0.65	0.67	0.63	7.75	8.04	7.50	1.86	1.81	1.90	45.0	46.6	43.6
	Percent Change	-2	-1	-3	-1	-3	1	8	4	12	33	27	39	-2	-3	-1
Total Sub-basin Area	Pre-Developed	631	616	642	0.67	0.71	0.63	7.83	8.67	7.18	2.35	2.67	2.09	42.61	44.36	41.26
	Developed	568	562	575	0.60	0.60	0.59	9.71	9.97	9.40	4.15	4.31	3.96	38.17	38.27	38.05
	Dev w/ PDFs	596	589	602	0.61	0.62	0.59	8.55	8.86	8.31	3.03	3.09	2.98	40.61	41.59	39.82
	Percent Change	-6	-4	-6	-9	-13	-6	9	2	16	29	16	42	-5	-6	-3

<sup>1</sup>This condition reflects sand mining and processing operation including Trampas Dam and a large quarry pit which limits runoff to Trampas Creek.

**Table 5-39: Comparison of Predicted Trace Metals Concentrations with Water Quality Criteria and Observed In-Stream Concentrations for the Central San Juan and Trampas Sub-basin (Alternative B-4)**

Trace Metals	Predicted Average Annual Concentration <sup>1</sup> (µg/L)			California Toxics Rule Criteria <sup>2</sup> (µg/L)	Observed Range of In-Stream Concentrations <sup>3</sup> (µg/L)
	All Years	Dry Years	Wet Years		
Total Aluminum	596	589	602	750 <sup>4</sup>	Not Monitored
Dissolved Cadmium	0.61	0.62	0.59	5.2	None Detected – 0.09
Dissolved Copper	8.6	8.9	8.3	15.9	2.1 – 4.0
Dissolved Lead	3.0	3.1	3.0	78.7	None Detected – 3.9
Dissolved Zinc	40.6	41.6	39.8	137	None Detected – 15.0

<sup>1</sup>Modeled concentration for total sub-basin area developed conditions with PDFs.

<sup>2</sup>Hardness = 120 mg/L, minimum value of monitoring data.

<sup>3</sup>Range of means observed at four San Juan watershed stations during the wet years.

<sup>4</sup>NAWQC criteria for pH 6.5 – 9.0.

### **5.4.3 Impacts on Pollutants of Concern – Alternative B-9**

The section presents the water quality modeling results used to address impacts of stormwater runoff on sediments, nutrients, and trace metals for Alternative B-9 in Planning Area 4 (East Central San Juan sub-basin). The modeling results presented above for the B-4 alternative are applicable to the B-9 alternative for the remaining planning areas (North CSJ/PA 3 and South CSJ & Trampas Canyon/PA 5), and therefore will not be repeated in this section.

#### ***TSS Loads and Concentrations***

Table 5-40 summarizes TSS loads and concentrations and shows the percent change associated with the proposed development for PA 4. TSS loads are predicted to decrease by about 40 percent and TSS concentrations are predicted to decrease by about 42 percent in all years. Table 5-41 also shows that the predicted post-development runoff TSS concentration in wet years is of the order of 132 mg/L, which is much lower than in-stream data collected by Wildermuth in the San Juan watershed.



**Table 5-40: Predicted Average Annual TSS Loads and Concentrations for Planning Area 4 within the Central San Juan and Trampas Sub-basin (Alternative B-9)**

Modeled Area	Site Condition	TSS Load (metric tons)			TSS Concentration (mg/L)		
		All Years	Dry Years	Wet Years	All Years	Dry Years	Wet Years
East CSJ/PA4	Pre-Developed	71	47	122	215	212	216
	Developed	77	58	119	119	114	125
	Dev w/ PDFs	43	26	77	124	114	132
	Percent Change	-40	-44	-37	-42	-46	-39

**Table 5-41: Comparison of Predicted TSS Concentration with Water Quality Objectives and Observed In-Stream Concentrations for Planning Area 4 in the Central San Juan and Trampas Sub-basin (Alternative B-9)**

Predicted Average Annual TSS Concentration <sup>1</sup> (mg/L)	San Diego Basin Plan Water Quality Objectives	Range of Observed In-stream Concentrations <sup>2</sup> (mg/L)
132	TSS levels shall not cause a nuisance or adversely affect beneficial uses as a result of controllable water quality factors	None Detected – 3,100

<sup>1</sup>Modeled concentration for PA 4 developed conditions with PDFs in wet years.

<sup>2</sup>Range of means observed at four San Juan watershed stations during the wet years.

NA – not applicable

### *Nutrient Loads and Concentrations*

Table 5-42 summarizes nutrient loads and shows percent changes for all years, dry years, and wet years respectively, for PA 4. PA 4 includes the approximately 15 acres of nurseries in the pre-developed condition. Nitrate nitrogen loads are projected to decrease by about 31 percent, whereas TKN loads are projected to more than double. Nitrate-nitrogen is inorganic nitrogen and is considered more bio-available than TKN, which contains both organic and inorganic forms of nitrogen. Projected loads are generally the largest during wet years and the lowest during dry years. Table 5-42 shows that total phosphorus loads are predicted to increase overall by about 122 percent.

Table 5-43 summarizes nutrient concentrations and indicates that the concentration of nitrate-nitrogen is projected to decrease by about 31 to 37 percent, whereas TKN concentration is projected to increase by about 138 percent for all years. Total phosphorous concentrations are projected to increase by as much as 116 percent during wet years.

Table 5-44 compares the predicted average annual runoff concentrations of nutrients with observed in-stream data from Wildermuth. The water quality concern here is excessive algal growth. The Basin Plan narrative objective is “Concentrations of nitrogen and phosphorous, by themselves or in combination with other nutrients, shall be maintained at levels below those which stimulate algae and emergent plant growth.” The results in the table indicate the predicted post-development runoff concentration for total phosphorous is less than that observed, where the observed data reflects the contribution from open areas and existing land uses. The higher observed nutrient data is consistent with the geologic information that indicates underlying bedrock may contribute high levels of phosphorous from open areas. Nitrate-nitrogen concentrations tend to be in the lower range of the observed data, and this is important, as mentioned above, as nitrate-nitrogen is more bioavailable than TKN. These projections would indicate that projected nutrient concentrations in runoff are comparable to or less than in-stream observations and therefore should not result in an increase in algal growth.

**Table 5-42: Predicted Average Annual Nutrient Loads for Planning Area 4 in the Central San Juan and Trampas Sub-basin (Alternative B-9) (lbs)**

Modeled Area	Site Condition	Nitrate-N Loads			TKN Loads			Total P Loads		
		All Years	Dry Years	Wet Years	All Years	Dry Years	Wet Years	All Years	Dry Years	Wet Years
East CSI/PA4	Pre-Developed	870	581	1481	791	539	1326	124	88	201
	Developed	1113	847	1677	3887	3124	5503	546	440	771
	Dev w/ PDFs	599	380	1063	1956	1372	3193	276	195	449
	Percent Change	-31	-35	-28	147	155	141	122	121	123

**Table 5-43: Predicted Average Annual Nutrient Concentrations for Planning Area 4 in the Central San Juan and Trampas Sub-basin (Alternative B-9) (mg/L)**

Modeled Area	Site Condition	Nitrate-N Concentration			TKN Concentration			Total P Concentration		
		All Years	Dry Years	Wet Years	All Years	Dry Years	Wet Years	All Years	Dry Years	Wet Years
East CSI/PA4	Pre-Developed	1.2	1.2	1.2	1.1	1.1	1.1	0.2	0.2	0.2
	Developed	0.8	0.8	0.8	2.7	2.8	2.6	0.4	0.4	0.4
	Dev w/ PDFs	0.8	0.8	0.8	2.6	2.7	2.5	0.4	0.4	0.3
	Percent Change	-34	-37	-31	138	144	132	113	111	116

**Table 5-44: Comparison of Predicted Nutrient Concentrations with Observed In-Stream Concentrations for Planning Area 4 in the Central San Juan and Trampas Sub-basin (Alternative B-9)**

Nutrient	Predicted Average Annual Concentration <sup>1</sup> (mg/L)			Observed Range of In-Stream Concentrations <sup>2</sup> (mg/L)
	All Years	Dry Years	Wet Years	
Nitrate	0.8	0.8	0.8	0.15 – 1.5
TKN	2.6	2.7	2.5	None Detected – 3.0
Total Phosphorus	0.4	0.4	0.3	None Detected – 2.8

<sup>1</sup>Modeled concentration for PA 4 developed conditions with PDFs.

<sup>2</sup>Range of means observed at four San Juan watershed stations during the wet years.

NA – not applicable

### ***Trace Metals***

Table 5-45 shows the predicted mean annual loads for aluminum, cadmium, copper, lead, and zinc for the three development scenarios and for the three climatic conditions. Except for aluminum, the concentrations are all in the dissolved form, which is the form addressed in the California Toxics Rule. For PA 4, the cadmium, copper, and lead loads are projected to increase by about two to 200 percent depending on the constituent and climatic condition. Aluminum and zinc loads are projected to decrease between approximately six to 10 percent. In general loads are higher in wet years and lower during dry years. The highest loads are associated with aluminum, then in descending order zinc, copper, lead, and cadmium.

Table 5-46 presents the predicted runoff concentrations. Overall, concentrations tend to decrease by about 12 percent for aluminum, about two percent for cadmium, and about 11 percent for zinc. Concentrations of dissolved copper are predicted to increase by about 43 to 48 percent depending on the climatic condition. Dissolved lead is predicted to about double overall. These concentration changes reflect changes associated with urbanization, the effects of bypassing higher flows around the water quality control facilities, and contributions from untreated open areas.

**Table 5-45: Predicted Average Annual Trace Metal Loads for Planning Area 4 in the Central San Juan and Trampas Sub-basin (Alternative B-9) (lbs)**

Modeled Area	Site Condition	Total Aluminum			Dissolved Cadmium			Dissolved Copper			Dissolved Lead			Dissolved Zinc		
		All Years	Dry Years	Wet Years	All Years	Dry Years	Wet Years	All Years	Dry Years	Wet Years	All Years	Dry Years	Wet Years	All Years	Dry Years	Wet Years
East CSJ/PA4	Pre-Developed	460	299	800	0.48	0.33	0.77	5.2	3.7	8.4	1.0	0.7	1.7	33	23	55
	Developed	790	609	1173	0.88	0.70	1.27	14.9	12.0	21.2	6.5	5.2	9.1	56	44	81
	Dev w/ PDFs	419	272	730	0.48	0.33	0.80	7.9	5.6	12.8	3.2	2.3	5.2	31	21	51
	Percent Change	-9	-9	-9	2	0	3	51	49	53	218	230	208	-8	-10	-6

**Table 5-46: Predicted Average Annual Trace Metal Concentrations for Planning Area 4 in the Central San Juan and Trampas Sub-basin (Alternative B-9) (µg/L)**

Modeled Area	Site Condition	Total Aluminum			Dissolved Cadmium			Dissolved Copper			Dissolved Lead			Dissolved Zinc		
		All Years	Dry Years	Wet Years	All Years	Dry Years	Wet Years	All Years	Dry Years	Wet Years	All Years	Dry Years	Wet Years	All Years	Dry Years	Wet Years
East CSJ/PA4	Pre-Developed	631	618	641	0.65	0.69	0.62	7	8	7	1.4	1.4	1.4	46	48	44
	Developed	551	545	559	0.62	0.62	0.61	10	11	10	4.5	4.7	4.4	39	39	38
	Dev w/ PDFs	552	538	564	0.64	0.66	0.62	10	11	10	4.3	4.5	4.1	41	42	40
	Percent Change	-12	-13	-12	-2	-5	0	46	43	48	206	215	197	-11	-13	-9

Table 5-47 compares the predicted mean annual concentrations with CTR criteria and observed in-stream data. The CTR criteria apply to acute aquatic toxicity and assume a hardness of 120 mg/L, which was the minimum observed hardness. As criteria increase with hardness, applying the minimum observed hardness is conservative, that is, would result in the minimum criteria. The table indicates that the projected mean runoff concentrations are well below the CTR criteria. The predicted runoff values tend to be higher than the observed in-stream data and, as discussed above, this may reflect the fact that we are comparing dissolved forms.

**Table 5-47: Comparison of Predicted Trace Metals Concentrations with Water Quality Criteria and Observed In-Stream Concentrations for Planning Area 4 in the Central San Juan and Trampas Sub-basin (Alternative B-9)**

Trace Metals	Predicted Average Annual Concentration <sup>1</sup> (µg/L)			California Toxics Rule Criteria <sup>2</sup> (µg/L)	Observed Range of In-Stream Concentrations <sup>3</sup> (µg/L)
	All Years	Dry Years	Wet Years		
Total Aluminum	552	538	564	750 <sup>4</sup>	Not Monitored
Dissolved Cadmium	0.64	0.66	0.62	5.2	None Detected – 0.09
Dissolved Copper	10	11	10	15.9	2.1 – 4.0
Dissolved Lead	4.3	4.5	4.1	78.7	None Detected – 3.9
Dissolved Zinc	41	42	40	137	None Detected – 15.0

<sup>1</sup>Modeled concentration for PA 4 developed conditions with PDFs.

<sup>2</sup>Hardness = 120 mg/L, minimum value of monitoring data.

<sup>3</sup>Range of means observed at four San Juan watershed stations during the wet years.

<sup>4</sup>NAWQC criteria for pH 6.5 – 9.0.

#### **5.4.4 Findings of Significance**

##### *Alternative B-4*

##### *Hydrologic Conditions of Concern and Significance Thresholds*

The following discusses the implications of the water balance results on the hydrologic conditions of concern.

##### 1. Increased Stormwater Runoff Flowrate, Volume and Flow Duration

Significance Threshold A: Substantially alter the existing drainage pattern of the site or area, including alteration of the course of a stream or river, in a manner that would cause substantial erosion or siltation.

The WQMP was designed specifically to preserve and protect the existing drainage patterns, and sediment transport regime. Drainage patterns within the development bubbles will be modified by the installation of drainage infrastructure, but to the extent feasible (for example, in low density development areas) more natural swale-type drainage will be considered. Drainage patterns will be modified in the Trampas Creek drainage by virtue of removing the sand mining operation; however, flow management is designed to mimic natural hydrologic conditions in Trampas Creek.

Significance Threshold B: Substantially increase the frequencies and duration of channel adjusting flows.

Changes in the frequency and duration of flows were analyzed for all of the catchments that would be affected by the proposed development. The combined control system for these catchments was sized and configured to match, to the extent possible, the flow durations over the entire range of channel adjusting flows, including the 2 and 10 year peak flows. A water balance also was conducted that took into account the effects of anticipated irrigation and the operation of the BMPs. The results of the water balance indicated that surface water runoff volume to Trampas Creek, to the unnamed creek west of Trampas Creek, and to San Juan Creek would effectively match the existing condition.

On this basis, the effect of the proposed development on altering existing drainage or increasing the frequency and duration of channel adjusting flows is determined to be less than significant.

## 2. Decreased Infiltration and Groundwater Recharge

Significance Threshold A: Substantially deplete groundwater supplies or interfere substantially with groundwater recharge that would cause a net deficit in aquifer volumes or lowering of the local groundwater table.

The water balance indicates that infiltration volumes will likely increase over pre-development conditions, and therefore groundwater levels, particularly in and around San Juan Creek, would increase rather than decrease.

On this basis, the potential effect of the proposed development on infiltration and groundwater recharge are considered less than significant.

### *Hydrologic Condition of Concern #3: Changed Base Flows*

Significance Threshold A: Substantially increase or decrease base flows as to negatively impact riparian habitat.

The projected increase in infiltration and groundwater outflow is likely to lead to increases in base flows in Trampas Creek, the unnamed creek, and San Juan Creek. The magnitude of the

increase is estimated to be about 1 cfs, which could potentially benefit arroyo toad habitat, especially during the breeding season when water is a significant factor affecting recruitment.

Significance Threshold B: Substantially increase or decrease low flow estimates where high groundwater elevations are considered important.

To the extent that the projected increase in base flows enter San Juan Creek, the effect could potentially raise the groundwater elevations downstream which would be beneficial to downstream water supply pumping operations.

On this basis, the effect of the proposed development in altering base flows such as to adversely affect habitat or downstream groundwater levels for water supply purposes is considered less than significant.

#### *Pollutants of Concern*

The following are the conclusions regarding the significance of impacts for the pollutants of concern under wet and dry weather conditions.

*Sediments:* Mean total suspended solids concentrations are predicted to be less in the post development condition than in the existing conditions.

*Nutrients (Nitrogen and Phosphorous):* Despite the predicted increases in TKN and total phosphorus loadings, the post-developed nutrient concentrations are either well below or within the observed range of in-stream concentrations and therefore should not increase algal growth..

*Trace Metals:* Mean concentrations of total aluminum and dissolved cadmium, copper, lead, and zinc are predicted to increase relative to predicted concentrations under existing conditions. However, mean concentrations of aluminum, cadmium, copper, lead, and zinc are well below benchmark NAWQC and CTR criteria.

On this basis, the impact of the B-4 alternative on sediments, nutrients, and trace metals is considered less than significant.

#### ***Alternative B-9***

##### *Hydrologic Conditions of Concern and Significance Thresholds*

The following discusses the implications of the water balance results on the hydrologic conditions of concern.

##### 1. Increased Stormwater Runoff Flowrate, Volume and Flow Duration

Significance Threshold A: Substantially alter the existing drainage pattern of the site or area, including alteration of the course of a stream or river, in a manner that would cause substantial erosion or siltation.

The WQMP was designed specifically to preserve and protect the existing drainage patterns, and sediment transport regime. Drainage patterns within the development bubbles will be modified by the installation of drainage infrastructure, but to the extent feasible (for example, in low density development areas) more natural swale type drainage will be considered. Drainage patterns will be modified in the Trampas Creek drainage by virtue of removing the sand mining operation; however, flow management is designed to mimic natural hydrologic conditions in Trampas Creek.

Significance Threshold B: Substantially increase the frequencies and duration of channel adjusting flows.

Changes in the frequency and duration of flows were analyzed for all of the catchments that would be affected by the proposed development. The combined control system for these catchments was sized and configured to match, to the extent possible, the flow durations over the entire range of channel adjusting flows, including the 2 and 10 year peak flows. A water balance also was conducted that took into account the effects of anticipated irrigation and the operation of the BMPs. The results of the water balance indicated that surface water runoff volume to Trampas Creek, to the unnamed creek west of Trampas Creek, and to San Juan Creek would effectively match the existing condition.

On this basis, the effect of the proposed development on altering existing drainage or increasing the frequency and duration of channel adjusting flows is determined to be less than significant.

## *2. Decreased Infiltration and Groundwater Recharge*

Significance Threshold A: Substantially deplete groundwater supplies or interfere substantially with groundwater recharge that would cause a net deficit in aquifer volumes or lowering of the local groundwater table.

The water balance indicates that infiltration volumes will likely increase over pre-development conditions, and therefore groundwater levels, particularly in and around San Juan Creek, would increase rather than decrease.

On this basis, the potential effect of the proposed development on infiltration and groundwater recharge are considered less than significant.

## *Hydrologic Condition of Concern #3: Changed Base Flows*

Significance Threshold A: Substantially increase or decrease base flows as to negatively impact riparian habitat.



The projected increase in infiltration and groundwater outflow is likely to lead to increases in base flows in Trampas Creek, the unnamed creek, and San Juan Creek. The magnitude of the increase is estimated to be about 1 cfs, which could potentially benefit arroyo toad habitat, especially during the breeding season when water is a significant factor affecting recruitment.

Significance Threshold B: Substantially increase or decrease low flow estimates where high groundwater elevations are considered important.

To the extent that the projected increase in base flows enter San Juan Creek, the effect could potentially raise the groundwater elevations downstream which would be beneficial to downstream water supply pumping operations.

On this basis, the effect of the proposed development in altering base flows such as to adversely affect habitat or downstream groundwater levels for water supply purposes is considered less than significant.

### ***Pollutants of Concern***

The following are the conclusions regarding the significance of impacts for the pollutants of concern under wet and dry weather conditions.

*Sediments:* Mean total suspended solids concentrations are predicted to be less in the post development condition than in the existing conditions.

*Nutrients (Nitrogen and Phosphorous):* Despite the predicted increases in TKN and total phosphorus loadings, the post-developed nutrient concentrations are either well below or within the observed range of in-stream concentrations, and therefore should not increase algal growth.

*Trace Metals:* Mean concentrations of total aluminum and dissolved cadmium, copper, lead, and zinc are predicted to increase relative to predicted concentrations under existing conditions. However, mean concentrations of aluminum, cadmium, copper, lead, and zinc are well below benchmark NAWQC and CTR criteria.

On this basis, the impact of Alternative B-9 on sediments, nutrients, and trace metals is considered less than significant.

## **5.5 IMPACT ANALYSIS FOR THE CRISTIANITOS SUB-BASIN**

This section evaluates the effectiveness of the WQMP for the Cristianitos Sub-basin and evaluates the impacts of the proposed Alternative B-4 on pollutants of concern and hydrologic conditions of concern within that sub-basin. This sub-basin contains Planning Area 6 and 7. No development is proposed within this sub-basin in the B-9 Alternative.

### **5.5.1 Impacts on Hydrologic Conditions of Concern**

The analysis of impacts on hydrologic conditions of concern took into account two flow control measures that were selected to limit impacts to Cristianitos Creek, which is considered sensitive to the adverse effects of increased runoff. Those measures consisted of grading a portion of the Planning Area 7 such that runoff would be directed to the Gabino Sub-basin, and routing excess flows from the remaining portion of PA 7 within the Cristianitos Sub-basin to Gabino Creek (Figure 5-26).

#### ***Hydrologic Condition of Concern #1: Increased Stormwater Runoff Volume, Peak Discharge, and Flow Duration***

##### Flow Duration Analysis

The flow duration analysis was conducted for catchments subject to development. Figure 5-27 shows an example of the flow duration analysis for the catchment designated PA7-9. The figure shows the effect of the proposed development on increasing the magnitude and duration of flows. The dashed horizontal lines indicate the estimated post-development 2 and 10 year peak flows. With controls (described in Chapter 4), the runoff flows and duration can be managed so as to essentially match the pre-development condition, and, as part of that matching, return the 2 and 10 peak flows to values consistent with the pre-development condition.

##### Water Balance Analysis

The water balance analysis for the Cristianitos Sub-basin was conducted for each of the two planning areas and for the sub-basin as a whole. The water balance results are shown in Figure 5-28 and Tables 5-48, 5-49, and 5-50 for all years, dry years, and wet years respectively. In contrast with areas in the San Juan Creek watershed where sandy soils provide high infiltration rates and storage volumes, most of the areas in the Cristianitos Sub-basin are clay or sandy loam soils and are underlain by clays at relatively shallow depths. Therefore, deep percolation of infiltrated water will be minimal and infiltrated water will tend to flow in shallow zones towards Cristianitos Creek. One of the prominent characteristics of this geology is that it does not support perennial systems. Figure 5-28 shows that groundwater outflow (magenta color) is generally high during the wetter months but is insufficient to support perennial flows throughout the year (except in one limited downstream portion of the sub-basin). The model confirmation of intermittent flow conditions is particularly important, as it indicates that the soil infiltration and groundwater storage processes are reasonably approximated by the model.

Because of the sensitivity to erosion in Cristianitos Creek, approximately 200 acres of PA 7 along the divide between the Cristianitos and Gabino sub-basins would be graded so as to divert excess runoff to the Gabino Sub-basin. It was also assumed in the model that infiltration would create a water table that is inclined towards Gabino and that groundwater under the graded area would flow towards Gabino Creek. Also note that the water balance results are provided in terms of inches of runoff and acre-ft of runoff. “Inches” as a volume measure is equivalent to

inches of water over the tributary drainage area. When there are large changes between the pre- and post-development tributary areas, the comparison using watershed inches as a volume measure can be misleading and acre-ft should be used.

The following describes the water balance results by planning area and for the sub-basin as a whole.

#### *Planning Area 6*

As indicated in the “pre-development inflow” columns, on average (based on all years) precipitation is about 15 in/yr, about 13 in/yr during dry years, and about 20 in/yr during wet years. Runoff to Cristianitos Creek is estimated to be about four percent of the precipitation irrespective of climatic conditions. In the post-development condition, irrigation of the golf course and common areas is predicted to add the equivalent of 10 inches of water for an increase of about a factor of two-thirds (the effect on the sub-basin scale is about 25 percent).

Under all years (Table 5-48), excess runoff corresponding to about 39 acre-ft is stored and recycled for golf course irrigation. Consequently, on average predicted runoff to Cristianitos Creek essentially replicates the pre-developed condition. During dry years (Table 5-49), the runoff is only about 50 percent of the pre-development runoff, and during wet years post-development runoff is slightly higher than pre-development runoff. It should be pointed out that matching pre-development conditions was conducted for the “average climatic “condition, that is all years. In general, this work indicates that the concept of flow control is feasible in the Cristianitos Sub-basin, and more precise matching for different climatic conditions, such as matching dry years pre-development runoff, can be achieved during a final design phase.

#### *Planning Area 7*

The water balance for that portion of PA 7 that is located in the Cristianitos Sub-basin is shown in Table 5-48 for all years, Table 5-49 for dry years, and Table 5-50 for wet years. Proposed grading would reduce the post-development area tributary to Cristianitos Creek by about 200 acres as a means of redirecting some of the excess runoff to the Gabino Sub-basin. In addition, the excess runoff from the remaining development in the Cristianitos Sub-basin would be diverted south (bypassing upper Cristianitos Creek) to discharge into the less sensitive Gabino Creek just upstream of the confluence with lower Cristianitos Creek. This dual routing of runoff is captured in the water balance which indicates that the net increase in runoff to upper Cristianitos Creek for all years is projected to be about 5 acre-ft or about a 10 percent increase. During wet years this percentage is about 20 percent. During dry years the increase is negligible. In all cases the changes in absolute values are quite low (less than 16 acre-ft/yr).

#### *Total Sub-basin*

Total sub-basin runoff to Cristianitos Creek is estimated to remain essentially the same as current conditions on average (for all water years). During wet years, the runoff is estimated to increase

by about 10 percent. During dry years, surface runoff to Cristianitos Creek is projected to decrease by about 10 percent (Table 5-41); however, the absolute runoff is quite low (50 acre-ft/yr) suggesting that there is limited runoff to Cristianitos Creek in dry years.

### ***Hydrologic Condition of Concern #2: Decreased Infiltration and Groundwater Recharge***

#### *Planning Area 6*

In general, the water balance results indicate relatively modest amounts of infiltration and groundwater outflow compared to the sub-basins analyzed in the San Juan watershed. The water balance results for PA 6 indicate that for all years, groundwater infiltration would increase from about 170 acre-ft/yr to about 232 acre-ft/yr or about 62 acre-ft/yr (36 percent). For dry years, groundwater infiltration and outflow would increase from about 86 acre-ft/yr to about 146 acre-ft/yr, for about 60 acre-ft/yr or 70 percent (Table 5-49). These effects are in part a reflection of the irrigation associated with the golf course. Thus development is projected to increase infiltration and groundwater recharge.

#### *Planning Area 7*

The clay soils in PA 7 limit infiltration rates and storage capacity. For all years, the infiltration in PA 7 is projected to decrease from about 76 acre-ft/yr or 24 percent (Table 5-48). During dry years, the decrease is about 30 acre-ft/yr or 18 percent (Table 5-40).

#### *Total Sub-basin*

For the total sub-basin, groundwater infiltration and outflow is projected to remain about the same at 750 acre-ft/yr. During wet years, there is a projected decrease in groundwater infiltration and outflow from about 1,565 acre-ft/yr to about 1,434 acre-ft/yr (less than a 10 percent decrease). The relatively large groundwater outflow during wet years reflects the effects of additional rainfall during the wet years (almost five additional inches per year). During dry years groundwater outflow is projected to increase from about 376 acre-ft/yr under pre-development conditions to about 415 acre-ft/yr for post-development conditions (approximately a 15 percent increase). These changes in groundwater outflow are quite modest overall and indicate that groundwater infiltration is not greatly affected in this sub-basin.

### ***Hydrologic Condition of Concern #3: Changed Base Flows***

#### *Planning Area 6*

The water balance analysis discussed above indicates that base flows are projected to increase under the post development condition. The mean annual increase in base flows assuming an additional 60 acre-ft/yr translates into an estimated base flow of less than 0.1 cfs. This is a very small increase in base flow which could easily evaporate, infiltrate in the main stem channel, or be utilized by riparian vegetation in the immediate vicinity of PA 6. Cristianitos Creek is an

intermittent stream and this minor addition of volume is likely not to change that condition, nor affect the downstream alkaline wetlands.

#### *Planning Area 7*

Base flows are projected to decrease slightly in PA 7 in part because of the grading that will redirect surface and groundwater flows to the Gabino Sub-basin. During dry years the decrease is only about 20 acre-ft, which will have little effect on the ephemeral stream. During wet years, the decrease is projected to be about 195 acre-ft which corresponds to a reduction of about 0.25 cfs (Table 5-50).

#### *Total Sub-basin*

As indicated above, groundwater infiltration for average conditions (all years) will remain unchanged, as will base flows. During wet years, the projected decrease of 130 acre-ft/yr translates into a decrease in base flow of about 0.2 cfs on average. During dry years, the projected increase in base flows is only about 0.05 cfs. These projections would indicate that the effects of the proposed development can be controlled such that base flows will not substantially be altered.

**Table 5-48: Cristianitos Sub-basin Average Annual Water Balance, All Years (Alternative B-4) (inches (acre-ft))**

Tributary Area	Pre-Development					Post-Development with PDFs								
	INFLOW	OUTFLOW				INFLOW			OUTFLOW					
	Precipitation	Runoff to Cristianitos Creek	GW Outflow	ET	Total	Precipitation	Irrigation	Total	Runoff to Cristianitos Creek	Stored Runoff for GC Irrig	Runoff Diverted to Gabino Creek	GW Outflow	ET	Total
<b>Planning Area 6<sup>1</sup></b>	15.1 (620)	0.6 (26)	4.2 (171)	10.3 (425)	15.1 (622)	15.0 (643)	10.0 (427)	25.0 (1070)	0.5 (20)	0.9 (39)	0.0 (0)	5.4 (232)	18.2 (780)	25.0 (1070)
<b>Planning Area 7<sup>2</sup></b>	15.0 (1099)	0.7 (52)	4.2 (310)	10.1 (739)	15.0 (1101)	14.8 (837)	4.4 (252)	19.2 (1089)	1.0 (57)	0.0 (0)	2.1 (121)	4.1 (234)	11.9 (676)	19.2 (1088)
<b>Total Sub-basin<sup>3</sup></b>	<b>14.8 (2923)</b>	<b>0.4 (79)</b>	<b>3.8 (758)</b>	<b>10.6 (2094)</b>	<b>14.8 (2930)</b>	<b>14.7 (2685)</b>	<b>3.7 (680)</b>	<b>18.4 (3364)</b>	<b>0.4 (79)</b>	<b>0.2 (39)</b>	<b>0.7 (121)</b>	<b>4.1 (742)</b>	<b>13.1 (2385)</b>	<b>18.4 (3366)</b>

<sup>1</sup>PA6 catchment shapes change from pre-development to post-development; the results presented include some open space outside of PA6. Thus, the total area is greater than the development area of PA6. Pre-development tributary area (Planning Area 6) = 493 acres; post-development tributary area = 515 acres.

<sup>2</sup>PA7 catchment shapes change from pre-development to post-development; the results presented include some open space outside of PA7. Thus, the total area is greater than the development area of PA7. Pre-development tributary area (Planning Area 7) = 881 acres; post-development tributary area = 680 acres.

<sup>3</sup>Pre-development tributary area (Total Sub-basin Area) = 2370 acres; post-development tributary area = 2191 acres.

**Table 5-49: Cristianitos Sub-basin Average Annual Water Balance, Dry Years (Alternative B-4) (inches (acre-ft))**

Tributary Area	Pre-Development					Post-Development with PDFs								
	INFLOW	OUTFLOW				INFLOW			OUTFLOW					
	Precipitation	Runoff to Cristianitos Creek	GW Outflow	ET	Total	Precipitation	Irrigation	Total	Runoff to Cristianitos Creek	Stored Runoff for GC Irrig	Runoff Diverted to Gabino Creek	GW Outflow	ET	Total
<b>Planning Area 6<sup>1</sup></b>	12.6 (519)	0.5 (21)	2.1 (86)	10.1 (416)	12.7 (523)	12.6 (539)	10.0 (427)	22.5 (966)	0.2 (10)	0.8 (36)	0.0 (0)	3.4 (146)	18.1 (774)	22.5 (966)
<b>Planning Area 7<sup>2</sup></b>	12.5 (920)	0.5 (36)	2.3 (167)	9.8 (722)	12.6 (926)	12.4 (701)	4.4 (252)	16.8 (952)	0.7 (39)	0.0 (0)	1.8 (102)	2.6 (146)	11.7 (665)	16.8 (953)
<b>Total Sub-basin<sup>3</sup></b>	<b>12.4 (2448)</b>	<b>0.3 (59)</b>	<b>1.9 (376)</b>	<b>10.3 (2030)</b>	<b>12.5 (2466)</b>	<b>12.3 (2248)</b>	<b>3.7 (679)</b>	<b>16.0 (2928)</b>	<b>0.3 (51)</b>	<b>0.2 (36)</b>	<b>0.6 (102)</b>	<b>2.3 (415)</b>	<b>12.8 (2331)</b>	<b>16.1 (2935)</b>

<sup>1</sup>PA6 catchment shapes change from pre-development to post-development; the results presented include some open space outside of PA6. Thus, the total area is greater than the development area of PA6. Pre-development tributary area (Planning Area 6) = 493 acres; post-development tributary area = 515 acres.

<sup>2</sup>PA7 catchment shapes change from pre-development to post-development; the results presented include some open space outside of PA7. Thus, the total area is greater than the development area of PA7. Pre-development tributary area (Planning Area 7) = 881 acres; post-development tributary area = 680 acres.

<sup>3</sup>Pre-development tributary area (Total Sub-basin Area) = 2370 acres; post-development tributary area = 2191 acres.

**Table 5-50: Cristianitos Sub-basin Average Annual Water Balance, Wet Years (Alternative B-4) (inches (acre-ft))**

Tributary Area	Pre-Development					Post-Development with PDFs								
	INFLOW	OUTFLOW				INFLOW			OUTFLOW					
	Precipitation	Runoff to Cristianitos Creek	GW Outflow	ET	Total	Precipitation	Irrigation	Total	Runoff to Cristianitos Creek	Stored Runoff for GC Irrig	Runoff Diverted to Gabino Creek	GW Outflow	ET	Total
<b>Planning Area 6<sup>1</sup></b>	20.3 (833)	0.9 (35)	8.5 (351)	10.8 (444)	20.2 (830)	20.1 (864)	10.0 (428)	30.1 (1292)	1.0 (42)	1.0 (44)	0.0 (0)	9.7 (414)	18.5 (792)	30.1 (1291)
<b>Planning Area 7<sup>2</sup></b>	20.1 (1478)	1.2 (85)	8.4 (614)	10.6 (775)	20.1 (1473)	19.9 (1126)	4.5 (252)	24.3 (1378)	1.6 (93)	0.0 (0)	2.9 (162)	7.4 (421)	12.3 (699)	24.3 (1375)
<b>Total Sub-basin<sup>3</sup></b>	<b>19.9 (3929)</b>	<b>0.6 (122)</b>	<b>7.9 (1565)</b>	<b>11.3 (2228)</b>	<b>19.8 (3915)</b>	<b>19.8 (3608)</b>	<b>3.7 (681)</b>	<b>23.5 (4290)</b>	<b>0.8 (138)</b>	<b>0.2 (44)</b>	<b>0.9 (162)</b>	<b>7.9 (1434)</b>	<b>13.7 (2500)</b>	<b>23.4 (4278)</b>

<sup>1</sup>PA6 catchment shapes change from pre-development to post-development; the results presented include some open space outside of PA6. Thus, the total area is greater than the development area of PA6. Pre-development tributary area (Planning Area 6) = 493 acres; post-development tributary area = 515 acres.

<sup>2</sup>PA7 catchment shapes change from pre-development to post-development; the results presented include some open space outside of PA7. Thus, the total area is greater than the development area of PA7. Pre-development tributary area (Planning Area 7) = 881 acres; post-development tributary area = 680 acres.

<sup>3</sup>Pre-development tributary area (Total Sub-basin Area) = 2370 acres; post-development tributary area = 2191 acres.

### 5.5.2 Impacts on Pollutants of Concern

The section presents the water quality modeling results used to address impacts of stormwater runoff on sediments, nutrients, and trace metals. The modeling analysis has been described in Chapter 3. The modeling results are in the form of mean annual loads and mean annual concentrations. Similar to the hydrologic impacts, results are provided for the three development scenarios: pre-development, post-development, and post-development with PDFs; for three climatic conditions: all years in the 53 year rainfall record, dry years, and wet years.

#### *TSS Loads and Concentrations*

Table 5-51 shows the mean annual loads and concentrations for TSS for each development scenario and climatic period. Mean annual loads are highest during the wet years and lowest during dry years. Loads also increase with development and decrease when controls are taken into account. Concentrations vary depending on the relative contribution of undeveloped areas, which contribute more TSS, compared to urbanized areas where runoff tends to have lower TSS. It is important to note however that the treatment controls are designed to control TSS from developed areas only. Contributions of sediment from undeveloped areas would remain unchanged. Table 5-51 shows modest relative reductions in both TSS concentrations and loads which, given that the development would be located on clay soils, would tend to be finer rather than coarser sediments. The reduction in TSS loads is typical of development, which has the effect of stabilizing soils with vegetation and covering soils with impervious surfaces.

Table 5-52 shows the mean annual TSS concentration of 126 mg/L for the total sub-basin during wet years and how it compares with water quality criteria and observed concentrations. The criterion for TSS in the San Diego Basin Plan is narrative and states that “levels shall not cause a nuisance or adversely affect beneficial uses as a result of controllable water quality factors”. The range of observed TSS data collected by Wildermuth at two stations in the San Mateo watershed was 3,900 to 9,400 mg/L. Thus the projected effects of the proposed development are not likely to affect in-stream TSS levels.

**Table 5-51: Predicted Average Annual TSS Loads and Concentrations for the Cristianitos Sub-basin (Alternative B-4)**

Modeled Area	Site Condition	TSS Load (metric tons)			TSS Concentration (mg/L)		
		All Years	Dry Years	Wet Years	All Years	Dry Years	Wet Years
Cristianitos Creek	Pre-Developed	14	10	22	143	138	149
	Developed	37	29	55	124	121	127
	Dev w/ PDFs	12	8	21	129	132	126
	Percent Change	-14	-21	-8	-10	-4	-16



**Table 5-52: Comparison of Predicted TSS Concentration with Water Quality Objectives and Observed In-Stream Concentrations for the Cristianitos Sub-basin (Alternative B-4)**

Predicted Average Annual TSS Concentration <sup>1</sup> (mg/L)	San Diego Basin Plan Water Quality Objectives	Range of Observed In-stream Concentrations <sup>2</sup> (mg/L)
126	TSS levels shall not cause a nuisance or adversely affect beneficial uses as a result of controllable water quality factors	3,900 – 9,400

<sup>1</sup>Modeled concentration for total sub-basin under developed conditions with PDFs in wet years.

<sup>2</sup>Range of observed concentrations at two San Mateo watershed stations during the wet years.

### *Nutrient Loads and Concentrations*

Tables 5-53 and 5-54 show the mean annual loads and concentrations for nitrate nitrogen, TKN, and total phosphorus. Nitrate-nitrogen and ammonia-nitrogen (a portion of the TKN measurement) are important bio-available forms of nitrogen that can contribute to algal growth in streams. TKN also includes organic forms of nitrogen that are generally considered less bioavailable. In this respect, nitrate-nitrogen is the more important species of nitrogen to consider when concerned about stimulating algal growth in streams.

Nitrate-nitrogen loads to Cristianitos Creek are projected to decrease by about 20 percent for dry years and remain about the same for wet years. Projected concentrations for all three development scenarios are within 0.05 mg/L. TKN loads and concentrations also are projected to decrease by about 10 to 50 percent compared to pre-development conditions. Total phosphorus loads and concentrations are projected to decrease by about 10 to 50 percent except for wet years when post-development with PDF conditions are projected to be about the same as pre-development.

Table 5-55 compares post-development concentrations with observed in-stream data. This table indicates that the predicted concentrations for nitrate-nitrogen and TKN are in the upper portion of the reported measured data. By contrast, the projected mean total phosphorus concentration is in the lower portion of the observed data. This comparison would indicate that runoff could increase concentrations of nitrate-nitrogen and TKN in Cristianitos Creek during storm runoff events. However, given the intermittent nature of the stream, the effect of increased nutrients is unlikely to create algal conditions because algae growth requires a sustained flow of water.

**Table 5-53: Predicted Average Annual Nutrient Loads for the Cristianitos Sub-basin (Alternative B-4) (lbs)**

Modeled Area	Site Condition	Nitrate-N Loads			TKN Loads			Total P Loads		
		All Years	Dry Years	Wet Years	All Years	Dry Years	Wet Years	All Years	Dry Years	Wet Years
Cristianitos Creek	Pre-Developed	178	129	283	329	254	487	53	41	79
	Developed	525	414	761	1529	1240	2140	222	181	310
	Dev w/ PDFs	164	106	286	217	118	427	40	22	78
	Percent Change	-8	-18	1	-34	-54	-12	-24	-46	0

**Table 5-54: Predicted Average Annual Nutrient Concentrations for the Cristianitos Sub-basin (Alternative B-4) (mg/L)**

Modeled Area	Site Condition	Nitrate-N Concentration			TKN Concentration			Total P Concentration		
		All Years	Dry Years	Wet Years	All Years	Dry Years	Wet Years	All Years	Dry Years	Wet Years
Cristianitos Creek	Pre-Developed	0.83	0.80	0.85	1.53	1.58	1.47	0.25	0.26	0.24
	Developed	0.79	0.78	0.80	2.30	2.33	2.25	0.33	0.34	0.33
	Dev w/ PDFs	0.79	0.80	0.79	1.05	0.89	1.17	0.20	0.17	0.22
	Percent Change	-4	0	-7	-31	-43	-20	-21	-34	-9

**Table 5-55: Comparison of Predicted Nutrient Concentrations with Observed In-Stream Concentrations for the Cristianitos Sub-basin (Alternative B-4)**

Nutrient	Predicted Average Annual Concentration <sup>1</sup> (mg/L)			Observed Range of In-Stream Concentrations <sup>2</sup> (mg/L)
	All Years	Dry Years	Wet Years	
Nitrate	0.79	0.80	0.79	0.29 – 1.1
TKN	1.05	0.89	1.17	0.39 – 1.2
Total Phosphorus	0.20	0.17	0.22	None Detected – 6.2

<sup>1</sup>Modeled concentration for developed conditions with PDFs in wet years.

<sup>2</sup>Range of means observed at two San Mateo watershed stations during the wet years.

NA – not applicable

### ***Trace Metals***

Tables 5-56 and 5-57 show the predicted mean annual loads and mean annual concentrations for aluminum, cadmium, copper, lead, and zinc for the three development scenarios and for the three climatic conditions. Except for aluminum, the concentrations are all in the dissolved form, which is the form addressed in the California Toxics Rule.

Loads and concentrations for all of the metals except aluminum tend to be generally projected to decrease. Concentrations of aluminum are projected to increase by a modest amount, ranging from about 5 to 10 percent. Aluminum loads in wet years are projected to increase by about 23 percent, whereas the loads are projected to decrease by about 15 percent during dry years.

The important comparison however is with the CTR criteria. Table 5-58 compares the projected mean concentration for wet years with the CTR criteria. A hardness of 140 mg/L has been used to estimate the CTR criteria for those metals whose criteria are hardness dependent. This value of hardness was the minimum hardness observed in the in-stream data collected by Wildermuth. Therefore the criteria may be viewed as a lower bound, and in this respect the comparison is conservative (i.e., more likely to indicate an exceedance). The table indicates that the projected mean concentrations are all less than these minimum CTR criteria, and therefore the effects of metals on acute aquatic toxicity is not likely to be significant. Table 5-58 also compares the projected runoff concentrations with observed data. This comparison indicates that dissolved runoff concentrations are projected to be less than dissolved in-stream concentrations. As discussed earlier, this situation may reflect the different dissolved-particulate equilibrium in the more sediment rich streams compared to the low sediment runoff.

**Table 5-56: Predicted Average Annual Trace Metal Loads for the Cristianitos Sub-basin (Alternative B-4) (lbs)**

Modeled Area	Site Condition	Total Aluminum			Dissolved Cadmium			Dissolved Copper			Dissolved Lead			Dissolved Zinc		
		All Years	Dry Years	Wet Years	All Years	Dry Years	Wet Years	All Years	Dry Years	Wet Years	All Years	Dry Years	Wet Years	All Years	Dry Years	Wet Years
Cristianitos Creek	Pre-Developed	114	83	179	0.20	0.15	0.30	2.53	1.95	3.76	0.44	0.35	0.65	13	10	20
	Developed	365	290	526	0.48	0.39	0.68	7.08	5.74	9.91	2.29	1.86	3.19	31	25	44
	Dev w/ PDFs	119	71	220	0.08	0.05	0.16	1.21	0.61	2.50	0.43	0.24	0.82	7	4	14
	Percent Change	4	-15	23	-58	-69	-46	-52	-69	-33	-3	-29	26	-48	-63	-31

**Table 5-57: Predicted Average Annual Trace Metal Concentrations for the Cristianitos Sub-basin (Alternative B-4) (µg/L)**

Modeled Area	Site Condition	Total Aluminum			Dissolved Cadmium			Dissolved Copper			Dissolved Lead			Dissolved Zinc		
		All Years	Dry Years	Wet Years	All Years	Dry Years	Wet Years	All Years	Dry Years	Wet Years	All Years	Dry Years	Wet Years	All Years	Dry Years	Wet Years
Cristianitos Creek	Pre-Developed	527	518	537	0.91	0.94	0.89	12	12	11	2.06	2.16	1.96	62	63	60
	Developed	549	545	553	0.72	0.73	0.71	11	11	10	3.43	3.49	3.36	47	48	47
	Dev w/ PDFs	575	536	604	0.40	0.35	0.44	6	5	7	2.08	1.85	2.26	34	28	38
	Percent Change	9	4	12	-56	-62	-51	-50	-62	-39	1	-14	15	-45	-55	-37

**Table 5-58: Comparison of Predicted Trace Metals Concentrations with Water Quality Criteria and Observed In-Stream Concentrations for the Cristianitos Sub-basin (Alternative B-4)**

Trace Metals	Predicted Average Annual Concentration <sup>1</sup> (µg/L)			California Toxics Rule Criteria <sup>2</sup> (µg/L)	Observed Range of In-Stream Concentrations <sup>3</sup> (µg/L)
	All Years	Dry Years	Wet Years		
Total Aluminum	527	518	537	750 <sup>4</sup>	Not Monitored
Dissolved Cadmium	0.40	0.35	0.44	6.1	None Detected – 0.37
Dissolved Copper	6	5	7	18	1.3 – 4.7
Dissolved Lead	2.08	1.85	2.26	93	None Detected – 0.19
Dissolved Zinc	34	28	38	160	None Detected – 26

<sup>1</sup>Modeled concentration for developed conditions with PDFs.

<sup>2</sup>Hardness = 140 mg/L, minimum value of monitoring data.

<sup>3</sup>Range of means observed at two San Mateo watershed stations during the wet years.

<sup>4</sup>NAWQC criteria for pH 6.5 – 9.0.

### **5.5.3 Findings of Significance**

#### ***Alternative B-4***

##### *Hydrologic Conditions of Concern and Significance Thresholds*

The following discusses the implications of the water balance results on the hydrologic conditions of concern.

#### 1. Increased Stormwater Runoff Flowrate, Volume and Flow Duration

Significance Threshold A: Substantially alter the existing drainage pattern of the site or area, including alteration of the course of a stream or river, in a manner that would cause substantial erosion or siltation.

The WQMP was designed specifically to preserve and protect the existing drainage patterns, and sediment transport regime. Drainage patterns within the development bubbles will be modified by the installation of drainage infrastructure, but to the extent feasible (for example, in low density development areas) more natural swale-like drainage will be considered.

Significance Threshold B: Substantially increase the frequencies and duration of channel adjusting flows.

Changes in the frequency and duration of flows were analyzed for catchments that discharge to Cristianitos Creek. Flow duration and volume runoff controls were selected to manage the frequency and duration of channel adjusting flows. These controls include routing runoff to storage for recycling for golf course irrigation, grading portions of the sub-basin to re-route flows to the Gabino Sub-basin, and routing excess flows from the Cristianitos Sub-basin into Gabino Creek. This combination of measures was modeled and the results indicated that it was possible to match durations over the entire range of channel adjusting flows, including the 2 and 10 year peak flows. A water balance also was conducted that took into account the effects of anticipated irrigation and the operation of the various flow control measures. The results of the water balance indicated that surface water runoff volume to Cristianitos Creek would effectively match the pre-developed condition.

On this basis, the effect of the proposed development on altering existing drainage or increasing the frequency and duration of channel adjusting flows is determined to be less than significant.

## 2. Decreased Infiltration and Groundwater Recharge

Significance Threshold A: Substantially deplete groundwater supplies or interfere substantially with groundwater recharge that would cause a net deficit in aquifer volumes or lowering of the local groundwater table.

The geology of this sub-basin limits deep groundwater recharge and what infiltration does occur tends to contribute to shallow interflow into the stream. The water balance indicates that infiltration volumes will likely mimic the existing condition.

On this basis, the potential effect of the proposed development on infiltration and groundwater recharge are considered less than significant.

## 3. Changed Base Flows

Significance Threshold A: Substantially increase or decrease base flows as to negatively impact riparian habitat.

Projected maximum changes to base flows are quite marginal (less than 0.1 cfs) and are insufficient to negatively impact habitat.

Significance Threshold B: Substantially increase or decrease low flow estimates where high groundwater elevations are considered important.

As discussed above, the geology and soils of this sub-basin limit the groundwater resource to shallow interflow. Nonetheless, the projected water balance results indicate the effect of the B-4 alternative is not likely to alter the groundwater balance.

On this basis, the effect of the proposed development in altering base flows such as to adversely affect habitat or downstream groundwater levels for water supply purposes is considered less than significant.

#### *Pollutants of Concern*

The following are the conclusions regarding the significance of impacts for the pollutants of concern under wet and dry weather conditions.

*Sediments:* Mean total suspended solids loads and concentrations are predicted to be less in the post development condition than in the existing conditions.

*Nutrients (Nitrogen and Phosphorous):* Mean nutrient loads and concentrations are predicted to generally be less in the post-development condition than in the existing conditions. Runoff concentrations are projected to be higher than measured instream data. However, the ephemeral nature of Cristianitos Creek substantially limits the potential for sustained algal growth.

*Trace Metals:* Mean concentrations of total aluminum and dissolved cadmium, copper, lead, and zinc are predicted to decrease relative to predicted concentrations under existing conditions. More significantly, mean concentrations of aluminum, cadmium, copper, lead, and zinc are well below benchmark NAWQC and CTR criteria.

On this basis, the impact of the B-4 alternative on sediments, nutrients, and trace metals in the Cristianitos Sub-basin is considered less than significant.

## 5.6 IMPACT ANALYSIS FOR THE GABINO SUB-BASIN

This section evaluates the effectiveness of the WQMP for the Gabino Sub-basin and evaluates the impacts of the B-4 alternative on pollutants of concern and hydrologic conditions of concern. No development is proposed within this sub-basin in Alternative B-9.

In this chapter we evaluate the effects of runoff from PA 7 into lower Gabino Creek, and a portion of PA 8C (about 50 acres) that is graded such that runoff is directed to middle Gabino Creek. (See Chapter 4 and Figure 5-26 for a description of the routing scheme.) Although Blind Canyon was considered along with Gabino in previous work such as the Baseline Conditions Report, we have chosen to discuss the impacts on Blind Canyon with those on Talega Canyon because proposed grading would direct runoff from the Northrop-Grumman area in the Talega Sub-basin into Blind Canyon.

In contrast to previous chapters where entire sub-basins were modeled, the water balance modeling was conducted only for lower Gabino, defined as catchments 68 to 80, and the PA 7 and PA 8 catchments illustrated in Figure 4-10 (Alternative B-4 Post-Development). The modeling does not include the proposed development in upper Gabino associated with PA 9, or the hydrologic contributions from existing open areas in middle and upper Gabino. A brief description of the anticipated impacts of the proposed development in upper Gabino is provided at the end of this section.

The decision to focus the analysis in Gabino on lower Gabino is reasonable given that most of the proposed development is located in lower Gabino. The results of the hydrologic and water quality analysis is therefore more of a relative comparison of pre- versus post-development conditions for discharges into lower Gabino, as opposed to an absolute comparison of hydrologic conditions within the stream.

### 5.6.1 Impacts on Hydrologic Conditions of Concern

#### ***Hydrologic Condition of Concern #1: Increased Stormwater Runoff Volume, Peak Discharge, and Flow Duration***

##### Water Balance Analysis

The water balance analysis for the Gabino Sub-basin addresses portions of PA 7 and a portion of PA 8C. As discussed in Section 5.5, excess runoff from catchments in PA 7 that would otherwise drain to Cristianitos Creek would be diverted to lower Gabino Creek at a point upstream of the confluence with Cristianitos Creek. In the water balance tables this diversion is referred to as “Runoff Diverted from Cristianitos Creek”.

Runoff from catchments in PA 7 that are currently located in the Gabino Sub-basin, along with additional catchments in PA 7 that are currently located in Cristianitos but would be graded to direct runoff into Gabino, would be stored and treated in the existing quarry pond in lower



Gabino (the pond nearest the road). Well data indicate that this pond is connected hydraulically to lower Gabino Creek and water levels can vary by 10 to 20 feet in response to changes in the elevation of the local water table. Based on available aerial photos, the surface area of the pond is approximately two acres, although the surface area would appear to be larger than two acres during high water conditions. The quarry pond currently does not have a surface outlet; however, if used as proposed, an outlet would be required to allow the basin to operate as an extended detention wet pond. Surface water would exit the pond through the outlet into lower Gabino Creek. This water is referred to in the water balance table (Table 5-59) as “Runoff to Gabino Creek”. Given the groundwater connection between the pond and Gabino Creek, water from the pond also would enter Gabino Creek through this connection. This is a potential benefit, in that the pond can act as a recharge area when stream flows are low, and seepage through the 150 to 200 feet of alluvium will further cleanse the water moving through the subsurface toward Gabino Creek.

A small 50 acre portion of PA 8C, including part of a golf course, also would drain to middle Gabino Creek. This runoff is also included in the water balance tables as “Runoff to Gabino Creek”. The columns in the water balance tables referred to as “Runoff Stored for GC Irrigation” represent runoff that would be diverted from this 50 acre area to non-domestic water supply reservoirs for use as golf course irrigation.

It is important to note that the pre-development catchments considered in the water balance total approximately 1,491 acres. However, because of the effects of the proposed grading, the total area of the post-development catchments is approximately 1,740 acres, for an increase of about 250 acres.

Because of these factors, surface water runoff into Gabino Creek is projected to increase on average (for all years) from about 45 acre-ft/yr to about 474 acre-ft/yr. This is the sum of the runoff to Gabino Creek from those portions of PA 7 in the Gabino Sub-basin (353 acre-ft/yr) and runoff diverted from Cristianitos Creek to Gabino Creek (121 acre-ft/yr). Increases during wet years would be larger, and increases during dry years would be less. This is considered acceptable because lower Gabino Creek, like San Juan Creek, is a relatively large, braided stream with coarse sized substrate that can accommodate increases in runoff without causing excessive erosion or inducing significant habitat changes. By comparison, increased runoff into Cristianitos Creek is considered likely to cause excessive erosion and possibly modify the existing alkaline wetland habitat.

### ***Hydrologic Condition of Concern #2: Decreased Infiltration and Groundwater Recharge***

As discussed earlier for Cristianitos Creek, the groundwater component of the water balance is smaller in these sub-basins in contrast to the sandy alluvial aquifers in the San Juan Creek watershed. This is particularly the case during dry years, when groundwater outflow is estimated to increase from about 356 acre-ft/yr to about 419 acre-ft/yr or about 20 percent. During wet years there is no projected change in groundwater recharge. These projected changes in

groundwater outflow indicate that groundwater infiltration is not greatly affected by the proposed development in this sub-basin.

### ***Hydrologic Condition of Concern #3: Changed Base Flow***

As indicated above, projected groundwater infiltration and outflow is relatively small in these geologic conditions, resulting in intermittent stream systems, especially during dry years. During such years, the change in groundwater outflow is projected to be about 63 acre-ft which translates into a mean annual increase in base flow of less than 0.1 cfs. These projections would indicate that base flows will not substantially be altered by the proposed development.

### **5.6.2 Impacts on Pollutants of Concern**

The section presents the water quality modeling results used to address impacts of stormwater runoff on sediments, nutrients, and trace metals. Results are provided for the three development scenarios, for three climatic conditions.

#### ***TSS Loads and Concentrations***

Table 5-60 shows that TSS concentrations are projected to decrease whereas, because of the increased runoff volume, TSS loads increase. Table 5-61 compares the projected mean annual TSS concentration (44 mg/L) to observed in-stream data that range from about 4,000 to 9,000 mg/L. These high in-stream concentration data further support the above conclusion that projected increases in runoff TSS loads are likely to be quite small compared to existing sediment transport in lower Gabino Creek.

**Table 5-59: Gabino Sub-basin Average Annual Water Balance<sup>1</sup> (inches (acre-ft))**

Climatic Period	Pre-Development <sup>2</sup>					Post-Development with PDFs <sup>3</sup>									
	INFLOW	OUTFLOW				INFLOW				OUTFLOW					
	Precipitation	Runoff to Gabino Creek	GW Outflow	ET	Total	Precipitation	Irrigation	Runoff Diverted from Cristianitos Sub-basin <sup>4</sup>	Total	Runoff to Gabino Creek <sup>4</sup>	Runoff Diverted from Cristianitos Sub-basin <sup>5</sup>	Runoff Stored for GC Irrigation <sup>6</sup>	GW Outflow	ET	Total
<b>All Years</b>	17.3 (2148)	0.4 (45)	5.2 (649)	11.8 (1461)	17.3 (2155)	16.5 (2392)	3.9 (560)	0.8 (121)	21.2 (3073)	2.4 (353)	0.8 (121)	0.1 (19)	4.8 (695)	13.2 (1912)	21.4 (3100)
<b>Dry Years</b>	14.5 (1802)	0.3 (35)	2.9 (356)	11.6 (1437)	14.7 (1828)	13.8 (2008)	3.9 (559)	0.7 (102)	18.4 (2669)	1.9 (282)	0.7 (102)	0.1 (16)	2.9 (419)	13.0 (1886)	18.6 (2704)
<b>Wet Years</b>	23.2 (2880)	0.5 (67)	10.2 (1271)	12.2 (1513)	22.9 (2850)	22.1 (3205)	3.9 (561)	1.1 (162)	27.1 (3928)	3.5 (504)	1.1 (162)	0.2 (25)	8.8 (1279)	13.6 (1968)	27.2 (3938)

<sup>1</sup>Water balance results for the lower Gabino Sub-basin; i.e. catchments that are directly tributary to Gabino Creek in PA7 and PA8, and excludes development areas in PA9.

<sup>2</sup>The pre-development catchments are 68-80. Pre-development area = 1491 acres.

<sup>3</sup>The post-development catchments are: 68-80, PA7-7, PA7-12, PA7-13, PA7-15, PA8-12, and PA8-14. Post-development area = 1740 acres.

<sup>4</sup>This is runoff from catchments that are tributary to Gabino Creek.

<sup>5</sup>This is treated runoff diverted from Cristianitos Sub-basin (inches are with respect to area of Lower Gabino).

<sup>6</sup>Assumed golf course storage volume was 10 AF.

**Table 5-60: Predicted Average Annual TSS Loads and Concentrations for the Gabino Sub-basin (Alternative B-4)**

Modeled Area	Site Condition	TSS Load (metric tons)			TSS Concentration (mg/L)		
		All Years	Dry Years	Wet Years	All Years	Dry Years	Wet Years
*Gabino	Pre-Developed	11	8	16	189	187	191
	Developed	76	61	107	123	122	124
	Dev w/ PDFs	29	22	44	53	49	58
	Percent Change	177	173	183	-72	-74	-69

\* Total loads draining into Gabino Creek. These include loads from Gabino Sub-basin and partially diverted loads from Cristianitos Sub-basin.

**Table 5-61: Comparison of Predicted TSS Concentration with Water Quality Objectives and Observed In-Stream Concentrations for the Gabino Sub-basin (Alternative B-4)**

Predicted Average Annual TSS Concentration <sup>1</sup> (mg/L)	San Diego Basin Plan Water Quality Objectives	Range of Observed In-stream Concentrations <sup>2</sup> (mg/L)
44	TSS levels shall not cause a nuisance or adversely affect beneficial uses as a result of controllable water quality factors	3,900 – 9,400

<sup>1</sup>Modeled concentration for total project developed conditions with PDFs in wet years.

<sup>2</sup>Range of concentrations observed at two San Mateo watershed stations during the wet years.

NA – not applicable

***Nutrient Loads and Concentrations***

Tables 5-62 and 5-63 show the mean annual loads and concentrations for nitrate-nitrogen, TKN, and total phosphorus. Nitrate-nitrogen and ammonia-nitrogen (a portion of the TKN measurement) are inorganic and more bio-available forms of nitrogen that can contribute to algal growth in streams. TKN also includes organic forms of nitrogen that are generally considered less bioavailable. In this respect, nitrate-nitrogen is the more important species of nitrogen to consider when concerned about stimulating algal growth in streams.

Nitrate-nitrogen concentrations are projected to decrease slightly with development, but the additional projected runoff volume causes loads to increase by a factor of about three. TKN loads and concentrations are projected to increase, with order of magnitude increases in loads projected. Total phosphorus loads and concentrations are also projected to increase.

Table 5-64 compares post-development concentrations with observed in-stream data. This table indicates that the predicted concentrations for nitrate-nitrogen are within the range of observed data, whereas the projected TKN concentrations are somewhat higher than in-stream concentrations. Given that these systems appear to be nitrogen limited and that nitrate-nitrogen is more bioavailable than TKN, changes in nitrate-nitrogen are the more important measure of the potential for discharges to stimulate algal growth. Table 5-63 indicates that nitrate-nitrogen concentrations would decrease slightly with development, and Table 5-64 indicates that projected runoff concentrations would fall within the range of observed in-stream data. Moreover, as discussed earlier for Cristianitos Creek, intermittent streams run during the wet winter season when environmental conditions of light and temperature are less supportive of algal growth.

Lastly, as discussed earlier, the combined control system includes constructed wetlands for treating dry weather flows and small storm flows. Constructed wetlands have been shown to be effective in reducing nitrate-nitrogen. Regional examples of successful applications of wetland technology include the Irvine Ranch Water District’s San Joaquin Marsh and the Prado Reservoir wetlands. Based on the success achieved in the San Joaquin Marsh, the Irvine Ranch Water District has recently developed a “Natural Treatment System” Master Plan calling for constructing a number of wetlands throughout the 122 square mile San Diego Creek watershed (IRWD, 2003). Modeling of this system has indicated that it will result in substantially achieving the nutrient TMDL targets for that watershed.

**Table 5-62: Predicted Average Annual Nutrient Loads for the Gabino Sub-basin (Alternative B-4) (lbs)**

Modeled Area	Site Condition	Nitrate-N Loads			TKN Loads			Total P Loads		
		All Years	Dry Years	Wet Years	All Years	Dry Years	Wet Years	All Years	Dry Years	Wet Years
Gabino	Pre-Developed	118	91	177	143	112	209	21	17	31
	Developed	1093	883	1535	3672	2998	5100	510	416	707
	Dev w/ PDFs	481	372	712	2115	1689	3016	337	272	475
	Percent Change	306	309	303	1377	1403	1346	1470	1504	1430

**Table 5-63: Predicted Average Annual Nutrient Concentrations for the Gabino Sub-basin (Alternative B-4) (mg/L)**

Modeled Area	Site Condition	Nitrate-N Concentration			TKN Concentration			Total P Concentration		
		All Years	Dry Years	Wet Years	All Years	Dry Years	Wet Years	All Years	Dry Years	Wet Years
Gabino	Pre-Develop	0.96	0.95	0.97	1.16	1.17	1.15	0.17	0.18	0.17
	Developed	0.80	0.80	0.80	2.68	2.70	2.67	0.37	0.37	0.37
	Dev w/ PDFs	0.40	0.38	0.43	1.75	1.71	1.80	0.28	0.28	0.28
	Percent Change	-59	-60	-56	51	46	57	60	56	66

**Table 5-64: Comparison of Predicted Nutrient Concentrations with Observed In-Stream Concentrations for the Gabino Sub-basin (Alternative B-4)**

Nutrient	Predicted Average Annual Concentration <sup>1</sup> (mg/L)			Observed Range of In-Stream Concentrations <sup>2</sup> (mg/L)
	All Years	Dry Years	Wet Years	
Nitrate-nitrogen	0.40	0.38	0.43	0.29 – 1.1
TKN	1.75	1.71	1.80	0.39 – 1.2
Total Phosphorus	0.28	0.28	0.28	None Detected – 6.2

<sup>1</sup>Modeled concentration for developed conditions with PDFs in wet years.

<sup>2</sup>Range of concentrations observed at two San Mateo watershed stations during the wet years.

NA – not applicable

***Trace Metals***

Tables 5-65 and 5-66 show the predicted mean annual loads and mean annual concentrations for aluminum, cadmium, copper, lead, and zinc for the three development scenarios and for the three climatic conditions. Except for aluminum, the concentrations are all in the dissolved form, which is the form addressed in the California Toxics Rule.

Concentrations for aluminum, cadmium and zinc are projected to decrease. Concentrations for dissolved copper are projected to essentially remain unchanged, and dissolved lead concentrations are projected to increase. Loads for all metals are projected to increase because of the increased runoff volumes.

**Table 5-65: Predicted Average Annual Trace Metal Loads for the Gabino Sub-basin (lbs)**

Modeled Area	Site Condition	Total Aluminum			Dissolved Cadmium			Dissolved Copper			Dissolved Lead			Dissolved Zinc		
		All Years	Dry Years	Wet Years	All Years	Dry Years	Wet Years	All Years	Dry Years	Wet Years	All Years	Dry Years	Wet Years	All Years	Dry Years	Wet Years
Gabino	Pre-Developed	77	60	115	0.09	0.07	0.12	1.16	0.93	1.66	0.25	0.20	0.36	10	8	14
	Developed	774	627	1085	0.79	0.64	1.10	13.29	10.87	18.43	5.96	4.87	8.26	51	41	71
	Dev w/ PDFs	674	550	937	0.63	0.52	0.88	12.11	9.96	16.67	3.46	2.76	4.95	45	37	62
	Percent Change	770	816	718	638	665	607	940	973	902	1287	1290	1283	357	367	344

**Table 5-66: Predicted Average Annual Trace Metal Concentrations for the Gabino Sub-basin (µg/L)**

Modeled Area	Site Condition	Total Aluminum			Dissolved Cadmium			Dissolved Copper			Dissolved Lead			Dissolved Zinc		
		All Years	Dry Years	Wet Years	All Years	Dry Years	Wet Years	All Years	Dry Years	Wet Years	All Years	Dry Years	Wet Years	All Years	Dry Years	Wet Years
Gabino	Pre-Develop	629	627	632	0.70	0.71	0.68	9.45	9.70	9.18	2.03	2.08	1.98	80	82	77
	Developed	566	564	568	0.58	0.58	0.57	9.72	9.78	9.64	4.35	4.38	4.32	37	37	37
	Dev w/ PDFs	559	557	560	0.52	0.52	0.52	10.03	10.09	9.97	2.87	2.80	2.96	37	37	37
	Percent Change	-11	-11	-11	-25	-26	-23	6	4	9	41	35	50	-53	-55	-52

The important comparison with respect to potential effects on aquatic species is with the benchmark CTR criteria, and in the case of aluminum, the NAWQA criteria. Table 5-67 compares the projected mean concentration for wet years with the CTR and NAWQA benchmark criteria. A hardness of 140 mg/L has been used to estimate the CTR criteria of those metals whose criteria are hardness dependent. This value of hardness was the minimum hardness observed in the in-stream data collected at the two monitoring stations in the San Mateo watershed by Wildermuth. Therefore the criteria may be viewed as a lower bound, and in this respect the comparison is conservative (i.e., more likely to indicate an exceedance). The table indicates that the projected mean concentrations of all the metals are well below the minimum criteria. In conclusion, concentrations of all trace metals are projected to be at lower concentrations than the benchmark criteria.

**Table 5-67: Comparison of Predicted Trace Metals Concentrations with Water Quality Criteria and Observed In-Stream Concentrations for the Gabino Sub-basin (Alternative B-4)**

Trace Metals	Predicted Average Annual Concentration <sup>1</sup> (µg/L)			California Toxics Rule Criteria <sup>2</sup> (µg/L)	Observed Range of In-Stream Concentrations <sup>3</sup> (µg/L)
	All Years	Dry Years	Wet Years		
Total Aluminum	559	557	560	750 <sup>4</sup>	Not Monitored
Dissolved Cadmium	0.52	0.52	0.52	6.1	None Detected – 0.37
Dissolved Copper	10.0	10.1	10	18	1.3 – 4.7
Dissolved Lead	2.87	2.80	2.96	93	None Detected – 0.19
Dissolved Zinc	37	37	37	160	None Detected – 26

<sup>1</sup>Modeled concentration for developed conditions with PDFs.

<sup>2</sup>Hardness = 140 mg/L, minimum value of monitoring data.

<sup>3</sup>Range of means observed at two San Mateo watershed stations during the wet years.

<sup>4</sup>NAWQC criteria for pH 6.5 – 9.0.

### 5.6.3 Findings of Significance

#### *Alternative B-4*

#### *Hydrologic Conditions of Concern and Significance Thresholds*



The following discusses the implications of the water balance results on the hydrologic conditions of concern.

#### 1. Increased Stormwater Runoff Flowrate, Volume and Flow Duration

Significance Threshold A: Substantially alter the existing drainage pattern of the site or area, including alteration of the course of a stream or river, in a manner that would cause substantial erosion or siltation.

The WQMP was designed specifically to preserve and protect the existing drainage patterns, and sediment transport regime. Development will alter existing drainage patterns in the side canyon above lower Gabino Creek in areas previously altered by prior mining activities and thus will not modify natural drainage patterns in these altered areas. Drainage patterns within the development bubbles will be modified by the grading and installation of drainage infrastructure. Some of the grading is specifically designed to divert runoff from approximately 200 acres in the more runoff sensitive neighboring Cristianitos Sub-basin to the Gabino Sub-basin, where stream conditions are considered more stable and resistant to the anticipated increase in flows.

Significance Threshold B: Substantially increase the frequencies and duration of channel adjusting flows.

Runoff volume in lower Gabino is projected to increase substantially with the proposed development, in large part because of the grading in the Cristianitos Sub-basin which will redirect flows from the Cristianitos Sub-basin into the Gabino Sub-basin. This and other runoff from PA 7 will be discharged into the large quarry pond in Lower Gabino, which is connected through the alluvial aquifer to nearby Gabino Creek. Gabino Creek is considered far more resistant to erosion than Cristianitos Creek.

On this basis, the effect of the proposed development on altering existing drainage or increasing the frequency and duration of channel adjusting flows is determined to be less than significant.

#### ***2. Decreased Infiltration and Groundwater Recharge***

Significance Threshold A: Substantially deplete groundwater supplies or interfere substantially with groundwater recharge that would cause a net deficit in aquifer volumes or lowering of the local groundwater table.

As discussed earlier for Cristianitos Creek, the groundwater component of the water balance is smaller in these sub-basins in contrast to the sandy alluvial aquifers in the San Juan Creek watershed. According to an evaluation of the Gabino alluvial/terrace groundwater basin conducted by Balance Hydrologics, the potential holding capacity of the Gabino groundwater basin is about 400 acre-ft primarily in the lower portion of the Gabino Sub-basin. The water balance during dry years projects that groundwater outflow will increase from about 356 acre-ft/yr to about 419 acre-ft/yr or about 20 percent. During wet years there is no projected change

in groundwater recharge. These projected changes in groundwater outflow indicate that groundwater recharge is not likely to decrease, but rather substantially fill the groundwater basin.

On this basis, the potential effect of the proposed development on infiltration and groundwater recharge are considered less than significant.

### ***3. Changed Base Flows***

Significance Threshold A: Substantially increase or decrease base flows as to negatively impact riparian habitat.

The increased availability of groundwater could encourage non-native vegetation or additional vegetation that could adversely affect aquatic species. However it is likely that riparian vegetation in lower Gabino is influenced more by channel scour than by groundwater level. If elevated groundwater conditions in lower Gabino were to adversely affect habitat, adaptive management options could include pumping the aquifer down each year in order to manage base flows for the maximum habitat value.

Significance Threshold B: Substantially increase or decrease low flow estimates where high groundwater elevations are considered important.

With the exception of the alluvial/terrace aquifers of Gabino, which are a part of this unit, the geology and soils of this sub-basin limit the groundwater resource to shallow interflow. Nonetheless the projected water balance results indicate the effect of the B-4 alternative is not likely to alter the groundwater balance and water table levels. If anything there may be a modest increase in groundwater levels during dry years.

On this basis, the effect of the proposed development in altering base flows such as to adversely affect habitat or groundwater levels is considered less than significant.

#### *Pollutants of Concern*

The following are the conclusions regarding the significance of impacts for the pollutants of concern under wet and dry weather conditions.

*Sediments*: Mean total suspended solids concentrations are predicted to be less in the post-development condition, but because of the increased runoff volume, loads are projected to increase. Because development will be located in areas with clay soils that are currently disturbed and eroding, the generation of fine sediments that originate from erosion of these clay soils will be reduced; whereas the transport of coarser sediment and cobbles generated in middle Gabino and La Paz Canyon will be maintained to and through lower Gabino Creek.

*Nutrients (Nitrogen and Phosphorous)*: Nitrate-nitrogen concentrations are projected to decrease with development; however, TKN and total phosphorus concentrations are projected to increase. Loads of all three nutrient species are projected to increase. Comparisons with observed in-

stream data indicate runoff nitrate-nitrogen concentrations will be comparable to observed in-stream concentrations. Also, as discussed earlier, the utilization of constructed wetlands for treatment has been shown to be effective in reducing nutrient concentrations. Given that nitrate-nitrogen is the more important nutrient of concern, this comparison would suggest that runoff would not increase algal growth in Gabino Creek or impact arroyo toad habitat. Moreover, as discussed earlier for Cristianitos Creek, intermittent streams run during the wet winter and spring season when environmental conditions of light and temperature are less supportive of algal growth.

*Trace Metals:* Although trace metal loads are projected to increase, mean concentrations of cadmium, copper, lead, and zinc are well below the benchmark CTR criteria. Total aluminum is also less than the benchmark NAWQA criterion for all climatic conditions.

On this basis, the impact of the B-4 alternative on sediments, nutrients, and trace metals in the Gabino Sub-basin is considered less than significant.

#### **5.6.4 Impacts Associated with Proposed Development in Upper Gabino**

The above discussion described the potential impacts associated with PA 6 and PA 7 on middle and lower Gabino. The B-4 alternative also includes development in Upper Gabino consisting of estate housing, casitas, and a golf course. The effects of this proposed low density development were not modeled, but rather are addressed here qualitatively.

##### ***Impacts to Hydrologic Conditions of Concern***

The golf course and casitas would be located in an area that has experienced extensive erosion because of natural erosive conditions coupled with past agricultural practices. Because of a combination of erodible clays and sands, Upper Gabino is a source of fine as well as coarse sediment. The Gabino sub-basin is underlain by clayey and crystalline terrains that generally produce high runoff volumes. So in this case, urbanization, especially the low density urbanization that is proposed, may not substantially increase post-development runoff. With development, grading, landscaping, and the incorporation of flow control facilities including recycling of stormwater for golf course irrigation are all factors that would reduce runoff volumes and rates into middle and lower Gabino Creek.

##### ***Impacts to Pollutants of Concern***

By siting the majority of the proposed development in an area that has suffered from past land use practices, the post-development sediment loads should decrease as a result of the landscaping associated with the golf course, and other urban landscaping that will tend to stabilize the soils. Low density development also will provide the opportunity to incorporate site design techniques that can provide for hydrologic as well as water quality control. Such techniques include directing roof and road runoff to bioinfiltration areas or swales. Given the clay conditions, soil amendments and underdrains could be employed to encourage infiltration. Runoff from low

density development also exhibits better water quality than runoff from more dense development.

Based on these considerations, the impacts of the proposed development in upper Gabino on water quality are considered less than significant.

## **5.7 IMPACT ANALYSIS FOR THE BLIND AND TALEGA SUB-BASINS**

This section evaluates the effectiveness of the WQMP for the Blind Canyon and Talega Canyon Sub-basins and evaluates the impacts of the proposed development on pollutants of concern and hydrologic conditions of concern.

In this section we evaluate the effects of runoff from PA 8 as it affects Talega and Blind Canyons. This area includes the Northrop-Grumman (formerly TRW) facilities. Because of concerns for arroyo toad habitat in Talega Creek, the proposed development plan is to grade PA 8 such that all excess runoff from PA 8 would discharge into either Blind Canyon to the north or lower Cristianitos to the west. The area of that portion of PA 8 that would be graded to discharge to Blind Canyon is approximately 473 acres. It is for this reason that the Blind and Talega Sub-basins are addressed in this section together.

In contrast to previous sections where entire sub-basins were modeled, the water balance and water quality modeling in these sub-basins were conducted for all the catchments in Blind Canyon and only for developed catchments in Talega Canyon. The decision to only model the developed portion of the Talega is reasonable given the grading plan.

### **5.7.1 Impacts on Hydrologic Conditions of Concern**

#### ***Alternative B-4***

#### ***Hydrologic Condition of Concern #1: Increased Stormwater Runoff Volume, Peak Discharge, and Flow Duration***

##### **Flow Duration Analysis**

The flow duration analysis was conducted for catchments subject to development. Figure 5-29 shows an example of the flow duration analysis for the 145 acre catchment designated PA8-6 (Figure 4-12). The figure shows the effect of the proposed development on increasing the magnitude and duration of flows. The dashed horizontal lines indicate the estimated post-development 2 and 10 year peak flows. With controls, the runoff flows and durations can be managed so as to essentially match the pre-development condition, and, as part of that matching, the 2 and 10 peak flows are reduced to values consistent with the pre-development condition.

## Water Balance Analysis

Tables 5-68 and 5-69 show the water balance results for the three climatic conditions for Blind Canyon and for the Talega development area, respectively. As indicated in Table 5-69, the only outflow from the graded area to Talega is some surface runoff (approximately 25 acre-ft) to approximately mimic existing conditions.

The column titled “Runoff to Blind Canyon” is the projected total surface runoff (70 acre-ft) generated in the sub-basin consisting primarily of that portion of PA 8 that is located in Blind Canyon. These results indicate that runoff to Blind Canyon Creek would increase from about 48 acre-ft/yr under the pre-development case to about 70 acre-ft/yr, an increase of 22 acre-ft or 45 percent. Approximately 42 acre-ft/yr of runoff from the golf course and the estate housing located upgradient of the golf course would be stored in non-domestic water supply reservoirs and used for irrigating the course and common areas.

### *Hydrologic Condition of Concern #2: Decreased Infiltration and Groundwater Recharge*

Because of the heavy reliance on groundwater infiltration to manage potentially erosive flows, groundwater outflow to Blind Canyon increases substantially. The total groundwater outflow consists of three components: (1) surface runoff from Talega Canyon that is being directed into the infiltration basins located in an alluvium area near the confluence of Blind Creek and Gabino Creek, (2) groundwater diverted from Talega by the grading, and (3) groundwater from within Blind Canyon. The total projected post-development groundwater outflow to Blind Creek, the sum of these three components, is about 902 acre-ft/yr. This is an increase of about 591 acre-ft over pre-development conditions. The effects of this infiltration would be to increase local groundwater table elevations, primarily in the lower portion of Blind Canyon.

Note that in this analysis we are assuming that groundwater flows in the graded portion of Talega Canyon will be redirected to Blind Canyon. The assumption is that the water table elevations will adjust to conform approximately to the land surface. However the direction of groundwater flows could be influenced by subsurface geologic formations such as clay lenses.

### *Hydrologic Condition of Concern #3: Changed Base Flow*

The projected increase in groundwater infiltration and outflow into Blind Canyon is approximately 591 acre-ft/yr, which translates into an annual mean change in base flow of about 0.8 cfs. This increase would occur near the mouth of Blind Creek and the effect could extend into lower Cristianitos Creek.

### ***Alternative B-9***

Figure 1-4 shows the proposed development areas under the B-9 alternative, which can be compared with the corresponding development areas under the B-4 alternative as shown in Figure 1-3. Table 4-25 lists the proposed land uses in the Blind and Talega Sub-basins under

each alternative. As indicated in the table and figures the proposed development under the B-9 alternative would be about 644 acres versus 661 acres for the B-4 alternative. Both alternatives would also include golf course and golf resort, although the golf course is larger in the B-9 alternative (225 acres versus 136 acres). The B-4 alternative includes 66 acres of golf residential that is not included in the B-9 alternative. As with the B-4 alternative, the grading plan for the B-9 alternative would be such that most of the post-development runoff from the Talega Sub-basin would be diverted north into Blind Canyon. This would be done in order to preserve the current hydrologic regime in Talega Creek which supports a large population of arroyo toads.

*Hydrologic Condition of Concern #1: Increased Stormwater Runoff Volume, Peak Discharge, and Flow Duration*

Flow Duration Analysis

The flow duration analysis was conducted for catchments subject to development. With controls, the runoff flows and durations are managed so as to essentially match the pre-development condition, and, as part of that matching, the 2 and 10 peak flows are reduced to values consistent with the pre-development condition.

Water Balance Analysis

Tables 5-70 and 5-71 show the water balance results for the three climatic conditions for Blind Canyon and for the Talega development area, respectively. As indicated in Table 5-70, the only outflow from the graded area to Talega is some surface runoff (approximately 36 acre-ft) to approximately mimic existing conditions.

The column titled “Runoff to Blind Canyon” is the projected total surface runoff (41 acre-ft) generated in the sub-basin consisting primarily of that portion of PA 8 that is located in Blind Canyon. These results indicate that runoff to Blind Canyon Creek would decrease slightly from about 48 acre-ft/yr under the pre-development case to about 41 acre-ft/yr, a decrease of 7 acre-ft or 15 percent. Approximately 106 acre-ft/yr of runoff from the golf would be stored in non-domestic water supply reservoirs and used for irrigating the golf course and common areas.

*Hydrologic Condition of Concern #2: Decreased Infiltration and Groundwater Recharge*

Because of the heavy reliance on groundwater infiltration to manage potentially erosive flows, groundwater outflow to Blind Canyon increases substantially. The total groundwater outflow consists of three components: (1) surface runoff from Talega Canyon that is being directed into the infiltration basins located in an alluvium area near the confluence of Blind Creek and Gabino Creek, (2) groundwater diverted from Talega by the grading, and (3) groundwater from within Blind Canyon. The total projected post-development groundwater outflow to Blind Creek, the sum of these three components, is about 829 acre-ft/yr. This is an increase of about 518 acre-ft over pre-development conditions. The effects of this infiltration would be to increase local groundwater table elevations, primarily in the lower portion of Blind Canyon.

Note than in this analysis we are assuming that groundwater flows in the graded portion of Talega Canyon will be redirected to Blind Canyon. The assumption is that the water table elevations will adjust to conform approximately to the land surface. However the direction of groundwater flows could be influenced by subsurface geologic formations such as clay lenses.

*Hydrologic Condition of Concern #3: Changed Base Flow*

The projected increase in groundwater infiltration and outflow into Blind Canyon is approximately 518 acre-ft/yr, which translates into an annual mean change in base flow of about 0.7 cfs. This increase would occur near the mouth of Blind Creek and the effect could extend into lower Cristianitos Creek.

**Table 5-68: Blind Sub-basin Average Annual Water Balance (Alternative B-4) (inches (acre-ft))**

Climatic Period	Pre-Development <sup>1</sup>					Post-Development with PDFs <sup>2</sup>							
	INFLOW	OUTFLOW				INFLOW			OUTFLOW				
	Precipitation	Runoff to Blind Canyon Creek	GW Outflow	ET	Total	Precipitation	Irrigation	Total	Runoff to Blind Canyon Creek	Runoff Stored for GC Irrigation <sup>4</sup>	GW Outflow <sup>4</sup>	ET	Total
<b>All Years</b>	16.8 (1026)	0.8 (48)	5.1 (311)	11.0 (672)	16.9 (1031)	15.7 (1654)	8.9 (937)	24.5 (2591)	0.7 (70)	0.4 (42)	8.5 (902)	15.4 (1626)	25.0 (2641)
<b>Dry Years</b>	14.1 (862)	0.6 (37)	2.8 (171)	10.8 (662)	14.2 (870)	13.1 (1387)	8.9 (936)	22.0 (2323)	0.4 (45)	0.4 (40)	6.3 (661)	15.3 (1617)	22.4 (2363)
<b>Wet Years</b>	22.5 (1375)	1.1 (70)	10.0 (609)	11.3 (693)	22.4 (1372)	21.0 (2218)	8.9 (939)	29.9 (3157)	1.2 (123)	0.4 (47)	13.4 (1412)	15.6 (1647)	30.6 (3229)

<sup>1</sup>The pre-development catchments are: 64,65,66,67. Pre-development area = 734 acres.

<sup>2</sup>The post-development catchments are: 64, 65, 66, PA8-3, PA8-4, PA8-5, PA8-6, PA8-7, PA8-8, PA8-9, PA8-10, PA8-11, and PA8-13. Post-development area = 1173 acres.

<sup>3</sup>Assumed golf course storage volume was 15 AF.

<sup>4</sup>Includes GW flows from Blind Cyn, GW flows from development areas in Talega Cyn, and treated surface runoff discharged to infiltration facilities.

**Table 5-69: Talega Sub-basin Average Annual Water Balance (Alternative B-4) (inches (acre-ft))**

Climatic Period	Pre-Development <sup>1</sup>					Post-Development with PDFs <sup>2</sup>			
	INFLOW	OUTFLOW				INFLOW			OUTFLOW
	Precipitation	Runoff to Talega Creek <sup>3</sup>	GW Outflow <sup>4</sup>	ET	Total	Precipitation	Irrigation	Total	Runoff to Talega Creek <sup>5</sup>
<b>All Years</b>	14.9 (586)	0.9 (35)	4.4 (172)	9.7 (383)	14.9 (589)	15.1 (801)	9.7 (517)	24.8 (1317)	0.5 (25)
<b>Dry Years</b>	12.5 (491)	0.7 (28)	2.3 (91)	9.5 (376)	12.6 (496)	12.6 (671)	9.7 (516)	22.3 (1187)	0.3 (18)
<b>Wet Years</b>	20.0 (788)	1.2 (47)	8.7 (343)	10.0 (396)	19.9 (786)	20.2 (1075)	9.7 (518)	30.0 (1593)	0.8 (42)

<sup>1</sup>The predevelopment catchments are 3, 4, 5, 6, 7, 8, 9a, and 9b. Pre-development area = 473 acres.

<sup>2</sup>Post-development area = 0 acres.

<sup>3</sup>Because only the development areas are modeled, runoff may not represent actual volumes that reach the stream. Surface runoff could infiltrate in open space areas between the development area and the stream.

<sup>4</sup>Because only the development areas are modeled, groundwater flows may not represent actual volumes that reach the stream. Some groundwater flows could be lost to ET, or groundwater flows could be greater if there is significant infiltration in the open space areas.

<sup>5</sup>Assumes that all flows from the developed catchments (PA8-3 to PA8-9) are collected in a pipe. There would be a flow splitter to divert some flows to Talega Creek (via a swale), and the remaining flows are diverted to Blind Canyon Creek.



**Table 5-70: Blind Sub-basin Average Annual Water Balance (Alternative B-9) (inches (acre-ft))**

Climatic Period	Pre-Development <sup>1</sup>					Post-Development with PDFs <sup>2</sup>							
	INFLOW	OUTFLOW				INFLOW			OUTFLOW				
	Precipitation	Runoff to Blind Canyon Creek	GW Outflow	ET	Total	Precipitation	Irrigation	Total	Runoff to Blind Canyon Creek	Runoff Stored for GC Irrigation <sup>3</sup>	GW Outflow <sup>4</sup>	ET	Total
<b>All Years</b>	16.8 (1026)	0.8 (48)	5.1 (311)	11.0 (672)	16.9 (1031)	16.1 (1573)	10.7 (1042)	26.8 (2616)	0.4 (41)	1.1 (106)	8.5 (829)	16.1 (1577)	26.5 (2589)
<b>Dry Years</b>	14.1 (862)	0.6 (37)	2.8 (171)	10.8 (662)	14.2 (870)	13.5 (1320)	10.7 (1041)	24.2 (2362)	0.3 (27)	1.1 (105)	6.3 (618)	16.1 (1572)	24.0 (2349)
<b>Wet Years</b>	22.5 (1375)	1.1 (70)	10.0 (609)	11.3 (693)	22.4 (1372)	21.6 (2110)	10.7 (1045)	32.3 (3155)	0.7 (71)	1.1 (107)	13.0 (1275)	16.2 (1587)	31.7 (3099)

<sup>1</sup>The pre-development catchments are: 64, 65, 66, 67. Pre-development area = 734 acres.

<sup>2</sup>The post-development catchments are: 64, 65, 66, 67, T-1. Post-development area = 1173 acres.

<sup>3</sup>Assumed golf course storage volume was 20 AF.

<sup>4</sup>Includes GW flows from Blind Cyn, GW flows from development areas in Talega Cyn, and treated surface runoff discharged to infiltration facilities.

**Table 5-71: Talega Sub-basin Average Annual Water Balance (Alternative B-9) (inches (acre-ft))**

Climatic Period	Pre-Development <sup>1</sup>					Post-Development with PDFs <sup>2</sup>			
	INFLOW	OUTFLOW				INFLOW			OUTFLOW
	Precipitation	Runoff to Talega Creek <sup>3</sup>	GW Outflow <sup>4</sup>	ET	Total	Precipitation	Irrigation	Total	Runoff to Talega Creek <sup>5</sup>
<b>All Years</b>	14.9 (526)	1.0 (36)	4.3 (153)	9.6 (340)	15.0 (529)	14.9 (525)	6.3 (220)	21.2 (745)	1.0 (36)
<b>Dry Years</b>	12.5 (441)	0.8 (30)	2.3 (81)	9.5 (334)	12.6 (445)	12.5 (440)	6.2 (220)	18.8 (660)	0.7 (26)
<b>Wet Years</b>	20.1 (707)	1.4 (50)	8.7 (305)	9.9 (350)	20.0 (705)	20.1 (705)	6.3 (220)	26.3 (925)	1.7 (59)

<sup>1</sup>The predevelopment catchments are 3, 4, 5, 6, 7, 8, 9a, and 9b. Pre-development area = 423 acres.

<sup>2</sup>Post-development area = 0 acres.

<sup>3</sup>Because only the development areas are modeled, runoff may not represent actual volumes that reach the stream. Surface runoff could infiltrate in open space areas between the development area and the stream.

<sup>4</sup>Because only the development areas are modeled, groundwater flows may not represent actual volumes that reach the stream. Some groundwater flows could be lost to ET, or groundwater flows could be greater if there is significant infiltration in the open space areas.

<sup>5</sup>Assumes that all flows from the developed catchments (PA8-3 to PA8-9) are collected in a pipe. There would be a flow splitter to divert some flows to Talega Creek (via a swale), and the remaining flows are diverted to Blind Canyon Creek.

## 5.7.2 Impacts on Pollutants of Concern – Alternative B-4

The section presents the water quality modeling results used to address impacts of stormwater runoff on sediments, nutrients, and trace metals for Alternative B-4. The results are provided for the three development scenarios, for three climatic conditions, and for Blind Canyon and the development area in Talega Canyon.

### *TSS Loads and Concentrations*

Table 5-72 shows the mean annual loads and concentrations for TSS for the Blind and Talega sub-basins. The “developed condition” row for Talega is assumed to be zero because of grading. However, it is assumed under the post-development with PDF scenario that some water will be directed from the graded area back into Talega Creek to maintain the existing water balance.

Table 5-72 indicates that concentrations and loads are projected to be quite low in both Blind Canyon and Talega Canyon. This effect reflects the relatively small areas proposed for development, soil stabilization achieved with urban landscaping, the increase in impervious cover, and the effect of treatment, and in particular, treatment by infiltration.

Table 5-73 shows the mean annual TSS concentration of 34 mg/L for runoff into Blind Canyon during wet years and how it compares with water quality criteria and observed in-stream concentrations. The criterion for TSS in the San Diego Basin Plan is narrative and states that “levels shall not cause a nuisance or adversely affect beneficial uses as a result of controllable water quality factors”. Observed concentrations reported by Wildermuth for two stations in the San Mateo Creek watershed range between about 4,000 to 9,000 mg/L. Consequently runoff will not adversely affect TSS levels in receiving streams.

**Table 5-72: Predicted Average Annual TSS Loads and Concentrations for the Blind and Talega Sub-basins (Alternative B-4)**

Modeled Area	Site Condition	TSS Load (metric tons)			TSS Concentration (mg/L)		
		All Years	Dry Years	Wet Years	All Years	Dry Years	Wet Years
Blind	Pre-Developed	11	9	17	190	188	192
	Developed	53	44	74	120	120	120
	Dev w/ PDFs	1.08	0.54	2.22	34	34	34
	Percent Change	-90	-94	-87	-82	-82	-82

Modeled Area	Site Condition	TSS Load (metric tons)			TSS Concentration (mg/L)		
		All Years	Dry Years	Wet Years	All Years	Dry Years	Wet Years
Talega	Pre-Developed	8	6	10	178	144	144
	Developed*	0	0	0	-	-	-
	Dev w/ PDFs	0.74	0.51	1.22	24	24	24
	Percent Change	-90	-92	-88	-87	-84	-84

\*For the Talega developed without PDFs condition, no flows will occur to Talega Creek from the development bubble.

**Table 5-73: Comparison of Predicted TSS Concentration with Water Quality Objectives and Observed In-Stream Concentrations for the Blind Sub-basin (Alternative B-4)**

Predicted Average Annual TSS Concentration <sup>1</sup> (mg/L)	San Diego Basin Plan Water Quality Objectives	Range of Observed In-stream Concentrations <sup>2</sup> (mg/L)
34	TSS levels shall not cause a nuisance or adversely affect beneficial uses as a result of controllable water quality factors	3,900 – 9,400

<sup>1</sup>Modeled concentration for developed conditions with PDFs in wet years.

<sup>2</sup>Range of concentrations observed at two San Mateo Creek watershed stations during the wet years.

NA – not applicable

### ***Nutrient Loads and Concentrations***

Tables 5-74 and 5-75 show the mean annual loads and concentrations for nitrate-nitrogen, TKN, and total phosphorus. Nitrate-nitrogen and ammonia-nitrogen (a portion of the TKN measurement) are important bio-available forms of nitrogen that can cause excessive algal growth in streams. TKN also contains organic nitrogen which is considered less bioavailable, and in this respect nitrate-nitrogen is the more important nitrogen species when considering effects on algal growth. Overall loads for nutrients will decrease in both Talega Canyon and Blind Canyon. Nitrogen concentrations will mostly decrease in both sub-basins. Total phosphorus concentrations will increase slightly in Talega Canyon. The substantial load reductions in Blind Canyon between “developed” and “developed with PDFs” reflect the effectiveness of infiltration.

Table 5-76 shows a comparison of the average annual concentrations of nutrients in runoff into Blind Canyon Creek with observed in-stream data from Wildermuth. Nitrate and total phosphorus are within the lower portion of the observed range, whereas TKN concentrations are

somewhat higher than the observed range. Given that TKN is less bioavailable, combined with the ephemeral nature of Blind Canyon Creek, it is unlikely that these concentrations would lead to excessive algal growth.

**Table 5-74: Predicted Average Annual Nutrient Loads for the Blind and Talega Sub-basins (Alternative B-4) (lbs)**

Modeled Area	Site Condition	Nitrate-N Loads			TKN Loads			TP Loads		
		All Years	Dry Years	Wet Years	All Years	Dry Years	Wet Years	All Years	Dry Years	Wet Years
Blind	Pre-Developed	99	74	150	251	202	357	34	27	48
	Developed	801	656	1109	2623	2155	3614	363	298	500
	Dev w/ PDFs	21	10	43	112	56	230	19	9	39
	Percent Change	-79	-86	-71	-56	-72	-36	-44	-65	-19
Talega	Pre-Developed	57	47	79	214	176	294	29	24	40
	Developed*	0	0	0	0	0	0	0	0	0
	Dev w/ PDFs	36	25	59	82	57	136	24	16	39
	Percent Change	-38	-48	-26	-62	-68	-54	-18	-31	-1

\*For the Talega developed without PDFs condition, no flows will occur to Talega Creek from the development bubble.

**Table 5-75: Predicted Average Annual Nutrient Concentrations for the Blind and Talega Sub-basins (Alternative B-4) (mg/L)**

Modeled Area	Site Condition	Nitrate-N Concentration			TKN Concentration			TP Concentration		
		All Years	Dry Years	Wet Years	All Years	Dry Years	Wet Years	All Years	Dry Years	Wet Years
Blind	Pre-Developed	0.76	0.73	0.79	1.94	1.99	1.87	0.26	0.27	0.25
	Developed	0.82	0.82	0.82	2.68	2.68	2.67	0.37	0.37	0.37
	Dev w/ PDFs	0.29	0.29	0.29	1.58	1.58	1.58	0.26	0.26	0.26
	Percent Change	-61	-60	-63	-18	-21	-16	2	-1	6

Modeled Area	Site Condition	Nitrate-N Concentration			TKN Concentration			TP Concentration		
		All Years	Dry Years	Wet Years	All Years	Dry Years	Wet Years	All Years	Dry Years	Wet Years
Talega	Pre-Developed	0.61	0.49	0.50	2.28	1.84	1.84	0.31	0.25	0.25
	Developed*	-	-	-	-	-	-	-	-	-
	Dev w/ PDFs	0.52	0.52	0.52	1.19	1.19	1.19	0.35	0.35	0.35
	Percent Change	-16	4	4	-48	-36	-36	12	39	39

\*For the Talega developed without PDFs condition, no flows will occur to Talega Creek from the development bubble.

**Table 5-76: Comparison of Predicted Nutrient Concentrations with Observed In-Stream Concentrations for the Blind Sub-basin (Alternative B-4)**

Nutrient	Predicted Average Annual Concentration <sup>1</sup> (mg/L)			Observed Range of In-Stream Concentrations <sup>2</sup> (mg/L)
	All Years	Dry Years	Wet Years	
Nitrate	0.29	0.29	0.29	0.29 – 1.1
TKN	1.58	1.58	1.58	0.39 – 1.2
Total Phosphorus	0.26	0.26	0.26	None Detected – 6.2

<sup>1</sup>Modeled concentration for developed conditions with PDFs.

<sup>2</sup>Range of concentrations observed at two San Mateo watershed stations during the wet years.

NA – not applicable

### **Trace Metals**

Tables 5-77 and 5-78 show the predicted mean annual loads and mean annual concentrations for aluminum, cadmium, copper, lead, and zinc for the three development scenarios and for the three climatic conditions. Except for aluminum, the concentrations are all in the dissolved form, which is the form addressed in the California Toxics Rule.

Overall concentrations and loads are projected to decrease in Blind Canyon and in the runoff to Talega Canyon. The only exception is a small increase in the concentration of cadmium in runoff into Blind Canyon.

The important comparison with respect to potential effects on aquatic species is with the CTR criteria, and in the case of aluminum, the NAWQA criteria. Table 5-79 compares the projected

mean concentrations with the benchmark CTR and NAWQA criteria. A hardness of 140 mg/L has been used to estimate the CTR criteria of those metals whose criteria are hardness dependent. This value of hardness was the minimum hardness observed in the in-stream data collected at the two monitoring stations in the San Mateo Creek watershed by Wildermuth. Therefore the criteria may be viewed as a lower bound, and in this respect the comparison is conservative (i.e., more likely to indicate an exceedance). The table indicates that the projected mean concentrations of all the metals are well below the benchmark criteria.

**Table 5-77: Predicted Average Annual Trace Metal Loads for the Blind and Talega Sub-basins (Alternative B-4) (lbs)**

Modeled Area	Site Condition	Total Aluminum			Dissolved Cadmium			Dissolved Copper			Dissolved Lead			Dissolved Zinc		
		All Years	Dry Years	Wet Years	All Years	Dry Years	Wet Years	All Years	Dry Years	Wet Years	All Years	Dry Years	Wet Years	All Years	Dry Years	Wet Years
Blind	Pre-Developed	103	81	150	0.05	0.04	0.08	1.80	1.46	2.53	0.84	0.69	1.17	27	22	37
	Developed	548	449	757	0.56	0.46	0.77	9.40	7.72	12.96	4.21	3.46	5.79	36	30	50
	Dev w/ PDFs	43	21	89	0.04	0.02	0.08	0.57	0.29	1.16	0.18	0.09	0.38	3	1	6
	Percent Change	-58	-74	-41	-28	-53	-1	-68	-80	-54	-78	-87	-68	-89	-93	-84
Talega	Pre-Develop	78	65	108	0.03	0.03	0.05	1.60	1.32	2.20	0.79	0.65	1.08	25	21	34
	Developed	0	0	0	0	0	0	0	0	0	0	0	0	0	0	0
	Dev w/ PDFs	38	27	63	0.02	0.01	0.03	0.42	0.29	0.70	0.27	0.19	0.45	2	1	3
	Percent Change	-51	-59	-41	-50	-58	-39	-74	-78	-68	-65	-71	-58	-93	-94	-91

\*For the Talega developed without PDFs condition, no flows will occur to Talega Creek from the development bubble.

**Table 5-78: Predicted Average Annual Trace Metal Concentrations for the Blind and Talega Sub-basins (Alternative B-4) (µg/L)**

Modeled Area	Site Condition	Total Aluminum			Dissolved Cadmium			Dissolved Copper			Dissolved Lead			Dissolved Zinc		
		All Years	Dry Years	Wet Years	All Years	Dry Years	Wet Years	All Years	Dry Years	Wet Years	All Years	Dry Years	Wet Years	All Years	Dry Years	Wet Years
Blind	Pre-Developed	795	802	787	0.40	0.39	0.40	14	14	13	6.48	6.79	6.13	206	216	194
	Developed	559	558	559	0.57	0.57	0.57	10	10	10	4.29	4.31	4.28	37	37	37
	Dev w/ PDFs	608	606	609	0.52	0.52	0.52	8	8	8	2.58	2.58	2.58	41	41	40
	Percent Change	-23	-24	-23	32	35	30	-42	-43	-40	-60	-62	-58	-80	-81	-79
Talega	Pre-Developed	837	676	676	0.36	0.29	0.29	17	14	14	8.37	6.77	6.76	267	216	215
	Developed*	-	-	-	-	-	-	-	-	-	-	-	-	-	-	-
	Dev w/ PDFs	556	556	556	0.25	0.25	0.25	6	6	6	3.93	3.93	3.93	26	26	26
	Percent Change	-34	-18	-18	-32	-15	-15	-64	-55	-55	-53	-42	-42	-90	-88	-88

\*For the Talega developed without PDFs condition, no flows will occur to Talega Creek from the development bubble.



**Table 5-79: Comparison of Predicted Trace Metals Concentrations with Water Quality Criteria and Observed In-Stream Concentrations for the Blind Sub-basin (Alternative B-4)**

Trace Metals	Predicted Average Annual Concentration <sup>1</sup> (µg/L)			California Toxics Rule Criteria <sup>2</sup> (µg/L)	Observed Range of In-Stream Concentrations <sup>3</sup> (µg/L)
	All Years	Dry Years	Wet Years		
Total Aluminum	608	606	609	750 <sup>4</sup>	Not Monitored
Dissolved Cadmium	0.52	0.52	0.52	6.1	None Detected – 0.37
Dissolved Copper	8	8	8	18	1.3 – 4.7
Dissolved Lead	2.6	2.6	2.6	93	None Detected – 0.19
Dissolved Zinc	41	41	40	160	None Detected – 26

<sup>1</sup>Modeled concentration for developed conditions with PDFs.

<sup>2</sup>Hardness = 140 mg/L, minimum value of monitoring data.

<sup>3</sup>Range of concentrations observed at two San Mateo watershed stations during the wet years.

<sup>4</sup>NAWQC criteria for pH 6.5 – 9.0.

### **5.7.3 Impacts on Pollutants of Concern – Alternative B-9**

The section presents the water quality modeling results used to address impacts of stormwater runoff on sediments, nutrients, and trace metals for Alternative B-9. The results are provided for the three development scenarios, for three climatic conditions, and for Blind Canyon and the development area in Talega Canyon.

#### ***TSS Loads and Concentrations***

Table 5-80 shows the mean annual loads and concentrations for TSS for the Blind and Talega sub-basins. The “developed condition” row for Talega is assumed to be zero because of grading. However, it is assumed under the post-development with PDF scenario that some water will be directed from the graded area back into Talega Creek to maintain the existing water balance.

Table 5-80 indicates that concentrations and loads are projected to be quite low in both Blind Canyon and Talega Canyon. This effect reflects the relatively small areas proposed for development, soil stabilization achieved with urban landscaping, the increase in impervious cover, and the effect of treatment, and in particular, treatment by infiltration.

Table 5-81 shows the mean annual TSS concentration of 52 mg/L for runoff into Blind Canyon during wet years and how it compares with water quality criteria and observed in-stream

concentrations. The criterion for TSS in the San Diego Basin Plan is narrative and states that “levels shall not cause a nuisance or adversely affect beneficial uses as a result of controllable water quality factors”. Observed concentrations reported by Wildermuth for two stations in the San Mateo Creek watershed range between about 4,000 to 9,000 mg/L. Consequently runoff will not adversely affect TSS levels in receiving streams.

**Table 5-80: Predicted Average Annual TSS Loads and Concentrations for the Blind and Talega Sub-basins (Alternative B-9)**

Modeled Area	Site Condition	TSS Load (metric tons)			TSS Concentration (mg/L)		
		All Years	Dry Years	Wet Years	All Years	Dry Years	Wet Years
Blind	Pre-Developed	11	9	17	190	188	192
	Developed	56	46	78	116	116	116
	Dev w/ PDFs	3	2	5	54	57	52
	Percent Change	-74	-77	-72	-71	-70	-73
Talega	Pre-Developed	8	7	11	178	178	178
	Developed*	0	0	0	0	0	0
	Dev w/ PDFs	1	1	2	24	24	24
	Percent Change	-87	-89	-84	-87	-87	-87

\*For the Talega developed without PDFs condition, no flows will occur to Talega Creek from the development bubble.

**Table 5-81: Comparison of Predicted TSS Concentration with Water Quality Objectives and Observed In-Stream Concentrations for the Blind Sub-basin (Alternative B-4)**

Predicted Average Annual TSS Concentration <sup>1</sup> (mg/L)	San Diego Basin Plan Water Quality Objectives	Range of Observed In-stream Concentrations <sup>2</sup> (mg/L)
52	TSS levels shall not cause a nuisance or adversely affect beneficial uses as a result of controllable water quality factors	3,900 – 9,400

<sup>1</sup>Modeled concentration for developed conditions with PDFs in wet years.

<sup>2</sup>Range of concentrations observed at two San Mateo Creek watershed stations during the wet years.

NA – not applicable

**Nutrient Loads and Concentrations**

Tables 5-82 and 5-83 show the mean annual loads and concentrations for nitrate-nitrogen, TKN, and total phosphorus. Nitrate-nitrogen and ammonia-nitrogen (a portion of the TKN measurement) are important bio-available forms of nitrogen that can cause excessive algal growth in streams. TKN also contains organic nitrogen which is considered less bioavailable, and in this respect nitrate-nitrogen is the more important nitrogen species when considering effects on algal growth. Overall loads and concentration for nitrate-nitrogen and TKN will decrease in both Talega Canyon and Blind Canyon. Total phosphorus will increase slightly in all years (six percent) and by approximately 30 percent in wet years. The substantial load reductions in Blind Canyon between “developed” and “developed with PDFs” reflect the effectiveness of infiltration.

Table 5-84 shows a comparison of the average annual concentrations of nutrients in runoff into Blind Canyon Creek with observed in-stream data from Wildermuth. All of the nutrients are within the observed range. Therefore, it is unlikely that these concentrations would lead to excessive algal growth.

**Table 5-82: Predicted Average Annual Nutrient Loads for the Blind and Talega Sub-basins (Alternative B-9) (lbs)**

Modeled Area	Site Condition	Nitrate-N Loads			TKN Loads			TP Loads		
		All Years	Dry Years	Wet Years	All Years	Dry Years	Wet Years	All Years	Dry Years	Wet Years
Blind	Pre-Developed	99	74	150	251	202	357	34	27	48
	Developed	893	732	1234	3031	2487	4183	412	338	568
	Dev w/ PDFs	70	48	117	138	92	234	36	24	61
	Percent Change	-29	-36	-22	-45	-54	-34	6	-12	28
Talega	Pre-Developed	60	50	83	226	186	310	30	25	42
	Developed*	0	0	0	0	0	0	0	0	0
	Dev w/ PDFs	51	36	83	118	83	191	34	24	55
	Percent Change	-16	-28	0	-48	-55	-38	12	-4	32

\*For the Talega developed without PDFs condition, no flows will occur to Talega Creek from the development bubble.

**Table 5-83: Predicted Average Annual Nutrient Concentrations for the Blind and Talega Sub-basins (Alternative B-9) (mg/L)**

Modeled Area	Site Condition	Nitrate-N Concentration			TKN Concentration			TP Concentration		
		All Years	Dry Years	Wet Years	All Years	Dry Years	Wet Years	All Years	Dry Years	Wet Years
Blind	Pre-Developed	0.76	0.73	0.79	1.94	1.99	1.87	0.26	0.27	0.25
	Developed	0.83	0.83	0.83	2.83	2.83	2.82	0.38	0.38	0.38
	Dev w/ PDFs	0.60	0.61	0.59	1.18	1.18	1.19	0.31	0.30	0.31
	Percent Change	-21	-17	-25	-39	-41	-37	18	14	23
Talega	Pre-Developed	0.61	0.61	0.61	2.28	2.28	2.28	0.31	0.31	0.31
	Developed*	0	0	0	0	0	0	0	0	0
	Dev w/ PDFs	0.52	0.52	0.52	1.19	1.19	1.19	0.35	0.35	0.35
	Percent Change	-16	-16	-16	-48	-48	-48	12	12	12

\*For the Talega developed without PDFs condition, no flows will occur to Talega Creek from the development bubble.

**Table 5-84: Comparison of Predicted Nutrient Concentrations with Observed In-Stream Concentrations for the Blind Sub-basin (Alternative B-9)**

Nutrient	Predicted Average Annual Concentration <sup>1</sup> (mg/L)			Observed Range of In-Stream Concentrations <sup>2</sup> (mg/L)
	All Years	Dry Years	Wet Years	
Nitrate	0.60	0.61	0.59	0.29 – 1.1
TKN	1.18	1.18	1.19	0.39 – 1.2
Total Phosphorus	0.31	0.30	0.31	None Detected – 6.2

<sup>1</sup>Modeled concentration for developed conditions with PDFs.

<sup>2</sup>Range of concentrations observed at two San Mateo watershed stations during the wet years.

NA – not applicable

### **Trace Metals**

Tables 5-85 and 5-86 show the predicted mean annual loads and mean annual concentrations for aluminum, cadmium, copper, lead, and zinc for the three development scenarios and for the three

climatic conditions. Except for aluminum, the concentrations are all in the dissolved form, which is the form addressed in the California Toxics Rule.

Overall concentrations and loads are projected to decrease in Blind Canyon and in the runoff to Talega Canyon.

The important comparison with respect to potential effects on aquatic species is with the benchmark CTR criteria, and in the case of aluminum, the NAWQA criteria. Table 5-87 compares the projected mean concentrations with the benchmark CTR and NAWQA criteria. A hardness of 140 mg/L has been used to estimate the CTR criteria of those metals whose criteria are hardness dependent. This value of hardness was the minimum hardness observed in the in-stream data collected at the two monitoring stations in the San Mateo Creek watershed by Wildermuth. Therefore the criteria may be viewed as a lower bound, and in this respect the comparison is conservative (i.e., more likely to indicate an exceedance). The table indicates that the projected mean concentrations of all the metals are well below the benchmark criteria.

**Table 5-85: Predicted Average Annual Trace Metal Loads for the Blind and Talega Sub-basins (Alternative B-9) (lbs)**

Modeled Area	Site Condition	Total Aluminum			Dissolved Cadmium			Dissolved Copper			Dissolved Lead			Dissolved Zinc		
		All Years	Dry Years	Wet Years	All Years	Dry Years	Wet Years	All Years	Dry Years	Wet Years	All Years	Dry Years	Wet Years	All Years	Dry Years	Wet Years
Blind	Pre-Developed	103	81	150	0.05	0.04	0.08	1.80	1.46	2.53	0.84	0.69	1.17	27	22	37
	Developed	604	495	835	0.54	0.44	0.75	9.62	7.89	13.28	4.85	3.98	6.70	36	29	49
	Dev w/ PDFs	67	46	114	0.03	0.02	0.06	0.72	0.48	1.23	0.40	0.27	0.68	3	2	5
	Percent Change	-35	-44	-24	-32	-40	-23	-60	-67	-52	-52	-61	-41	-88	-90	-85
Talega	Pre-Develop	83	68	113	0.04	0.03	0.05	1.69	1.39	2.32	0.83	0.68	1.14	26	22	36
	Developed	0	0	0	0	0	0	0	0	0	0	0	0	0	0	0
	Dev w/ PDFs	56	40	91	0.02	0.02	0.04	0.61	0.43	0.98	0.39	0.27	0.63	3	2	4
	Percent Change	-32	-41	-19	-31	-41	-19	-64	-69	-57	-53	-60	-44	-90	-92	-89

\*For the Talega developed without PDFs condition, no flows will occur to Talega Creek from the development bubble.

**Table 5-86: Predicted Average Annual Trace Metal Concentrations for the Blind and Talega Sub-basins (Alternative B-9) (µg/L)**

Modeled Area	Site Condition	Total Aluminum			Dissolved Cadmium			Dissolved Copper			Dissolved Lead			Dissolved Zinc		
		All Years	Dry Years	Wet Years	All Years	Dry Years	Wet Years	All Years	Dry Years	Wet Years	All Years	Dry Years	Wet Years	All Years	Dry Years	Wet Years
Blind	Pre-Developed	795	802	787	0.40	0.39	0.40	14	14	13	6.48	6.79	6.13	206	216	194
	Developed	564	563	564	0.51	0.51	0.51	9	9	9	4.52	4.52	4.52	33	33	33
	Dev w/ PDFs	579	583	576	0.30	0.30	0.30	6	6	6	3.44	3.41	3.46	28	28	28
	Percent Change	-27	-27	-27	-24	-22	-26	-55	-57	-53	-47	-50	-43	-87	-87	-86
Talega	Pre-Developed	837	837	837	0.36	0.36	0.36	17	17	17	8.38	8.38	8.38	267	267	267
	Developed*	0	0	0	0	0	0	0	0	0	0	0	0	0	0	0
	Dev w/ PDFs	570	570	570	0.25	0.25	0.25	6	6	6	3.93	3.93	3.93	26	26	26
	Percent Change	-32	-32	-32	-31	-31	-31	-64	-64	-64	-53	-53	-53	-90	-90	-90

\*For the Talega developed without PDFs condition, no flows will occur to Talega Creek from the development bubble.

**Table 5-87: Comparison of Predicted Trace Metals Concentrations with Water Quality Criteria and Observed In-Stream Concentrations for the Blind Sub-basin (Alternative B-9)**

Trace Metals	Predicted Average Annual Concentration <sup>1</sup> (µg/L)			California Toxics Rule Criteria <sup>2</sup> (µg/L)	Observed Range of In-Stream Concentrations <sup>3</sup> (µg/L)
	All Years	Dry Years	Wet Years		
Total Aluminum	579	583	576	750 <sup>4</sup>	Not Monitored
Dissolved Cadmium	0.30	0.30	0.30	6.1	None Detected – 0.37
Dissolved Copper	6	6	6	18	1.3 – 4.7
Dissolved Lead	3.44	3.41	3.46	93	None Detected – 0.19
Dissolved Zinc	28	28	28	160	None Detected – 26

<sup>1</sup>Modeled concentration for developed conditions with PDFs.

<sup>2</sup>Hardness = 140 mg/L, minimum value of monitoring data.

<sup>3</sup>Range of concentrations observed at two San Mateo watershed stations during the wet years.

<sup>4</sup> NAWQC criteria for pH 6.5 – 9.0.

#### **5.7.4 Findings of Significance**

##### ***Alternative B-4***

##### *Hydrologic Conditions of Concern and Significance Thresholds*

The following discusses the implications of the water balance results on the hydrologic conditions of concern.

##### 1. Increased Stormwater Runoff Flowrate, Volume and Flow Duration

Significance Threshold A: Substantially alter the existing drainage pattern of the site or area, including alteration of the course of a stream or river, in a manner that would cause substantial erosion or siltation.

The WQMP was designed specifically to preserve and protect the existing drainage patterns, and sediment transport regime. Drainage patterns within the development bubbles will be modified by the grading and installation of drainage infrastructure. Some of the grading is specifically designed to divert runoff from approximately in the more sensitive Talega Sub-basin to Blind Canyon and ultimately to lower Cristianitos, where stream conditions are considered more stable and resistant to the anticipated increase in flows.



Significance Threshold B: Substantially increase the frequencies and duration of channel adjusting flows.

Runoff volume in lower Blind Canyon is projected to increase on average by about 22 acre-ft, which is unlikely to affect channel stability.

On this basis, the effect of the proposed development on altering existing drainage or increasing the frequency and duration of channel adjusting flows is determined to be less than significant.

## 2. Decreased Infiltration and Groundwater Recharge

Significance Threshold A: Substantially deplete groundwater supplies or interfere substantially with groundwater recharge that would cause a net deficit in aquifer volumes or lowering of the local groundwater table.

Because of the reliance on infiltration as a volume control measure, groundwater infiltration is projected to increase in Blind Canyon and especially near the confluence with Gabino and lower Cristianitos Creeks. On this basis, the potential effect of the proposed development on infiltration and groundwater recharge are considered less than significant.

## 3. Changed Base Flows

Significance Threshold A: Substantially increase or decrease base flows as to negatively impact riparian habitat.

Groundwater outflow into lower Blind Canyon Creek is projected to increase by about 591 acre-ft/yr, which translates into a mean increase in base flows of about 0.8 cfs. This effect would be mostly in lower Cristianitos Creek. Because of its size, substrate, and habitat, lower Cristianitos Creek is considered more suitable for accepting additional flows than Talega Creek. The base flow will decrease with distance downstream as some water will infiltrate into the stream bed and some water may be used to support riparian vegetation, especially in Lower Cristianitos Creek which, in certain reaches, is heavily vegetated.

Significance Threshold B: Substantially increase or decrease low flow estimates where high groundwater elevations are considered important.

As discussed above, the projected effect of the development would, if anything, increase base flows and local groundwater elevations. The effect would be most pronounced in lower Cristianitos Creek where existing habitat could potentially benefit from the additional water. On this basis, the effect of the proposed development in altering groundwater levels is considered less than significant.

### *Pollutants of Concern*

The following are the conclusions regarding the significance of impacts for the pollutants of concern under wet and dry weather conditions.

*Sediments*: Mean total suspended solids loads and concentrations are predicted to be less in the post-development condition.

*Nutrients (Nitrogen and Phosphorous)*: Post-developed nutrient loads are predicted to decrease and post-development concentrations are either well below or within the observed range of in-stream concentrations. Moreover the treatment system will include constructed wetlands to treat dry weather and small storm flows. Wetland systems such as those at the San Joaquin Marsh and Prado Reservoir have been shown to be quite effective in treating nitrate-nitrogen. On this basis, the impact of the B-4 alternative on nutrients is considered less than significant.

*Trace Metals*: Mean concentrations of total aluminum and dissolved cadmium, copper, lead, and zinc are predicted to decrease relative to predicted concentrations under existing conditions and are well below benchmark NAWQC and CTR criteria. On this basis, the impact of the B-4 alternative on trace metals is less than significant.

### ***Alternative B-9***

#### *Hydrologic Conditions of Concern and Significance Thresholds*

The following discusses the implications of the water balance results on the hydrologic conditions of concern.

##### 1. Increased Stormwater Runoff Flowrate, Volume and Flow Duration

Significance Threshold A: Substantially alter the existing drainage pattern of the site or area, including alteration of the course of a stream or river, in a manner that would cause substantial erosion or siltation.

The WQMP was designed specifically to preserve and protect the existing drainage patterns, and sediment transport regime. Drainage patterns within the development bubbles will be modified by the grading and installation of drainage infrastructure. Some of the grading is specifically designed to divert runoff from approximately in the more sensitive Talega Sub-basin to Blind Canyon and ultimately to lower Cristianitos, where stream conditions are considered more stable and resistant to the anticipated increase in flows.

Significance Threshold B: Substantially increase the frequencies and duration of channel adjusting flows.

Runoff volume in lower Blind Canyon is projected to decrease on average by about 7 acre-ft due to the effectiveness of the combined control system.

On this basis, the effect of the proposed development on altering existing drainage or increasing the frequency and duration of channel adjusting flows is determined to be less than significant.

## 2. Decreased Infiltration and Groundwater Recharge

Significance Threshold A: Substantially deplete groundwater supplies or interfere substantially with groundwater recharge that would cause a net deficit in aquifer volumes or lowering of the local groundwater table.

Because of the reliance on infiltration as a volume control measure, groundwater infiltration is projected to increase in Blind Canyon and especially near the confluence with Gabino and lower Cristianitos Creeks. On this basis, the potential effect of the proposed development on infiltration and groundwater recharge are considered less than significant.

## 3. Changed Base Flows

Significance Threshold A: Substantially increase or decrease base flows as to negatively impact riparian habitat.

Groundwater outflow into lower Blind Canyon Creek is projected to increase by about 518 acre-ft/yr, which translates into a mean increase in base flows of about 0.7 cfs. This effect would be mostly in lower Cristianitos Creek. Because of its size, substrate, and habitat, lower Cristianitos Creek is considered more suitable for accepting additional flows than Talega Creek. The base flow will decrease with distance downstream as some water will infiltrate into the stream bed and some water may be used to support riparian vegetation, especially in Lower Cristianitos Creek which, in certain reaches, is heavily vegetated.

Significance Threshold B: Substantially increase or decrease low flow estimates where high groundwater elevations are considered important.

As discussed above, the projected effect of the development would, if anything, increase base flows and local groundwater elevations. The effect would be most pronounced in lower Cristianitos Creek where existing habitat could potentially benefit from the additional water. On this basis, the effect of the proposed development in altering groundwater levels is considered less than significant.

### *Pollutants of Concern*

The following are the conclusions regarding the significance of impacts for the pollutants of concern under wet and dry weather conditions.

*Sediments:* Mean total suspended solids loads and concentrations are predicted to be less in the post-development condition.

*Nutrients (Nitrogen and Phosphorous):* Post-developed nitrogen loads and concentrations are predicted to decrease and total phosphorus concentrations are predicted to increase slightly. Post-development concentrations are within the observed range of in-stream concentrations. Moreover the treatment system will include constructed wetlands to treat dry weather and small storm flows. Wetland systems such as those at the San Joaquin Marsh and Prado Reservoir have been shown to be quite effective in treating nitrate-nitrogen. On this basis, the impact of the B-4 alternative on nutrients is considered less than significant.

*Trace Metals:* Mean concentrations of total aluminum and dissolved cadmium, copper, lead, and zinc are predicted to decrease relative to predicted concentrations under existing conditions and are well below benchmark NAWQC and CTR criteria. On this basis, the impact of the B-4 alternative on trace metals is less than significant.

## **5.8 IMPACT ANALYSIS FOR THE VERDUGO SUB-BASIN**

This section evaluates the effectiveness of the WQMP for the Verdugo Sub-basin and evaluates the impacts of the proposed development on pollutants of concern and hydrologic conditions of concern.

### **5.8.1 B4 Alternative**

Planning Area 9 includes 200 acres of estate housing in upper Gabino, Verdugo, and Central San Juan. Of the 240 acres, 54 acres would be in lower Verdugo. Given that estate homes will be widely disbursed with extensive landscaping, low impact site design techniques will be feasible. Such controls would be conducted onsite or in common areas and will include treatment practices such as vegetated swales and planter boxes. Water quality facilities will be designed to meet the MS4 Permit sizing criteria. Hydromodification controls will be designed to match pre-development volume, flow duration, and water balance conditions to the extent feasible.

#### ***Effects on Hydrologic Conditions of Concern***

The estate homes would be located primarily in lower Verdugo Canyon in the San Juan Creek watershed. This area is characterized by infiltrative and highly erodible silty soils. Upper portions of the canyon contain erodible sands and the canyon is considered an important source of sand and gravel sediments during larger episodic storm events. Lack of subsurface water limits base flows and results in relatively dry upland and riparian plant communities. Given the infiltrative soils and sparse development surrounded by open space, volume control utilizing planter boxes and vegetated swales would be effective in matching pre-development runoff conditions.

#### ***Effects on Pollutants of Concern***

Pollutant generation will be minimal given the low density of development. Fine sediment production is anticipated to be reduced as a result of urban landscaping. Irrigation controls and

pesticide and fertilizer management educational programs would be provided to manage dry weather runoff and pollution. Roof runoff could be directed to planter boxes effectively treating pollutants that could be associated with atmospheric deposition on roof materials. The density of housing is compatible with swales along the arterial roads, in contrast to traditional curb and gutter, which would effectively treat road runoff. The resulting runoff from PA 9 is projected to meet the water quality significance criteria, and the discharges are therefore considered to be less than significant in affecting the water quality of Verdugo Creek.

### **5.8.2 B9 Alternative**

This section evaluates the effectiveness of the WQMP for the Verdugo Sub-basin and evaluates the impacts of the B-9 alternative on pollutants of concern and hydrologic conditions of concern. Alternative B-9 includes 479 acres of proposed development within the Verdugo Sub-basin.

In contrast to previous chapters where entire sub-basins were modeled, the modeling was conducted only for the lower Verdugo Sub-basin, defined as catchments 120 to 125, PA4-4, and PA4-5 (illustrated in Figure 4-14 (B9 Post-Development)). The modeling does not include the hydrologic contributions from existing open areas in the upper portion of the sub-basin.

The decision to focus the analysis in Verdugo on the lower portion of the sub-basin is reasonable given that the proposed development is located in lower Verdugo. The results of the hydrologic and water quality analysis is therefore more of a relative comparison of pre- versus post-development conditions for discharges into lower Verdugo Creek, as opposed to an absolute comparison of hydrologic conditions within the stream.

### **5.8.3 Impacts on Hydrologic Conditions of Concern**

#### ***Hydrologic Condition of Concern #1: Increased Stormwater Runoff Volume, Peak Discharge, and Flow Duration***

##### **Flow Duration Analysis**

One flow duration/water quality basin has been provided for the PA 4 development within the Verdugo Sub-basin. The flow duration analysis results are presented in Figure 5-30. Also shown on the figure are the estimated 2 and 10 year return period post-development peak flows. These flows were estimated based on a frequency analysis of peak flows from the SWMM output for the 53 year rainfall record. The figure indicates that the flow controls effectively match the pre-development flow duration curve for a range of flows up to and beyond the 10 year peak flow. These results indicate that matching pre-development flow duration up to the 10 year peak flow was possible utilizing the combined control system in the Verdugo Sub-basin.

## Water Balance Analysis

The water balance analysis results presented in Table 5-88 address the portion of PA 4 within the Verdugo Sub-basin. It is important to note that the pre-development catchments considered in the water balance total approximately 1,514 acres. However, because of the effects of the proposed grading, the total area of the post-development catchments is approximately 1,576 acres, for an increase of about 62 acres.

Surface water runoff into Verdugo Creek is projected to increase on average (for all years) from about 28 acre-ft/yr to about 31 acre-ft/yr, or three acre-ft/yr. Increases during wet years would be slightly larger (4 acre-ft/yr), and increases during dry years would be slightly less (1 acre-ft/yr). These increase in surface runoff are minimal due to the effectiveness of the combined control system.

### *Hydrologic Condition of Concern #2: Decreased Infiltration and Groundwater Recharge*

Groundwater outflow is projected to increase from 997 acre-ft/yr to 1,844 acre-ft/yr in all years, or approximately 85 percent, due to the use of infiltration and the added irrigation volumes. These projected changes in groundwater outflow indicate that groundwater infiltration and groundwater recharge will not be decreased by the proposed development in this sub-basin.

### *Hydrologic Condition of Concern #3: Changed Base Flow*

The water balance analysis indicates that post-development groundwater outflow will increase by about 847 acre-ft or 85 percent for all years and about 831 acre-ft (127 percent) during dry years (Table 5-88). This groundwater outflow would ultimately increase base flows in Verdugo Creek, which would be utilized to support riparian vegetation, increase levels of the water table, or infiltrate into the channel bottom.

**Table 5-88: Verdugo Sub-basin Average Annual Water Balance (Alternative B-9) (inches (acre-ft))**

Climatic Period	Pre-Development <sup>1</sup>					Post-Development with PDFs <sup>2</sup>						
	INFLOW	OUTFLOW				INFLOW			OUTFLOW			
	Precipitation	Runoff to Verdugo Creek	GW Outflow	ET	Total	Precipitation	Irrigation	Total	Runoff to Verdugo Creek	GW Outflow	ET	Total
<b>All Years</b>	17.2 (2173)	0.2 (28)	7.9 (997)	9.1 (1145)	17.2 (2171)	17.3 (2268)	7.4 (971)	24.7 (3239)	0.2 (31)	14.0 (1844)	10.3 (1358)	24.6 (3234)
<b>Dry Years</b>	14.4 (1822)	0.0 (6)	5.2 (654)	9.3 (1175)	14.5 (1834)	14.5 (1901)	7.4 (970)	21.9 (2871)	0.1 (7)	11.3 (1485)	10.5 (1380)	21.9 (2873)
<b>Wet Years</b>	23.1 (2916)	0.6 (77)	13.7 (1725)	8.6 (1083)	22.9 (2885)	23.2 (3045)	7.4 (973)	30.6 (4019)	0.6 (81)	19.8 (2606)	10.0 (1312)	30.4 (3998)

<sup>1</sup>The pre-development catchments are 120-125. Pre-development area = 1514 acres.

<sup>2</sup>The post-development catchments are: 120 – 125, PA4-4, and PA4-5. Post-development area = 1576 acres.

#### 5.8.4 Impacts on Pollutants of Concern

The section presents the water quality modeling results used to address impacts of stormwater runoff on sediments, nutrients, and trace metals. Results are provided for the three development scenarios, for three climatic conditions.

##### *TSS Loads and Concentrations*

Table 5-89 shows that TSS loads are projected to decrease in all but dry years and concentrations are always predicted to decrease. Table 5-90 compares the projected mean annual TSS concentration in wet years (208 mg/L) to observed in-stream data that range up to 3,100 mg/L.

**Table 5-89: Predicted Average Annual TSS Loads and Concentrations for the Verdugo Sub-basin (Alternative B-9)**

Modeled Area	Site Condition	TSS Load (metric tons)			TSS Concentration (mg/L)		
		All Years	Dry Years	Wet Years	All Years	Dry Years	Wet Years
Verdugo Creek	Pre-Developed	7.8	1.5	21.1	224	224	224
	Developed	45	33	71	125	118	133
	Dev w/ PDFs	7.7	1.6	20.5	206	191	208
	Percent Change	-1	9	-3	-8	-15	-7

**Table 5-90: Comparison of Predicted TSS Concentration with Water Quality Objectives and Observed In-Stream Concentrations for the Verdugo Sub-basin (Alternative B-9)**

Predicted Average Annual TSS Concentration <sup>1</sup> (mg/L)	San Diego Basin Plan Water Quality Objectives	Range of Observed In-stream Concentrations <sup>2</sup> (mg/L)
208	TSS levels shall not cause a nuisance or adversely affect beneficial uses as a result of controllable water quality factors	None Detected – 3,100

<sup>1</sup>Modeled concentration for developed conditions with PDFs in wet years.

<sup>2</sup>Range of concentrations observed at four San Juan watershed stations during storm events.

##### *Nutrient Loads and Concentrations*

Tables 5-91 and 5-92 show the mean annual loads and concentrations for nitrate-nitrogen, TKN, and total phosphorus. Nitrate-nitrogen concentrations are projected to decrease slightly with



development, but the additional projected runoff volume causes loads to increase slightly. TKN loads and concentrations are projected to increase by approximately 43 percent and 33 percent, respectively. Total phosphorus loads and concentrations are similarly projected to increase.

Table 5-93 compares post-development concentrations with observed in-stream data. This table indicates that the predicted concentrations for all of the nutrients are within the range of observed data.

**Table 5-91: Predicted Average Annual Nutrient Loads for the Verdugo Sub-basin (Alternative B-9) (lbs)**

Modeled Area	Site Condition	Nitrate-N Loads			TKN Loads			Total P Loads		
		All Years	Dry Years	Wet Years	All Years	Dry Years	Wet Years	All Years	Dry Years	Wet Years
Verdugo Creek	Pre-Developed	89	17	242	75	14	203	9.5	1.8	25.8
	Developed	642	484	976	2181	1777	3037	302	247	419
	Dev w/ PDFs	91	20	241	107	29	272	14.1	3.9	35.6
	Percent Change	2	15	-0.3	43	104	34	48	115	38

**Table 5-92: Predicted Average Annual Nutrient Concentrations for the Verdugo Sub-basin (Alternative B-9) (mg/L)**

Modeled Area	Site Condition	Nitrate-N Concentration			TKN Concentration			Total P Concentration		
		All Years	Dry Years	Wet Years	All Years	Dry Years	Wet Years	All Years	Dry Years	Wet Years
Verdugo Creek	Pre-Develop	1.16	1.16	1.16	0.98	0.98	0.98	0.12	0.12	0.12
	Developed	0.80	0.78	0.83	2.73	2.85	2.59	0.38	0.40	0.36
	Dev w/ PDFs	1.10	1.04	1.11	1.30	1.56	1.25	0.17	0.21	0.16
	Percent Change	-6	-10	-5	33	60	28	37	68	32

**Table 5-93: Comparison of Predicted Nutrient Concentrations with Observed In-Stream Concentrations for the Verdugo Sub-basin (Alternative B-9)**

Nutrient	Predicted Average Annual Concentration <sup>1</sup> (mg/L)			Observed Range of In-Stream Concentrations <sup>2</sup> (mg/L)
	All Years	Dry Years	Wet Years	
Nitrate-nitrogen	1.10	1.04	1.11	0.15 – 1.5
TKN	1.30	1.56	1.25	None Detected – 3.0
Total Phosphorus	0.17	0.21	0.16	None Detected – 2.8

<sup>1</sup>Modeled concentration for developed conditions with PDFs in wet years.

<sup>2</sup>Range of concentrations observed at four San Juan watershed stations during storm events.

### ***Trace Metals***

Tables 5-94 and 5-95 show the predicted mean annual loads and mean annual concentrations for aluminum, cadmium, copper, lead, and zinc for the three development scenarios and for the three climatic conditions. Except for aluminum, the concentrations are all in the dissolved form, which is the form addressed in the California Toxics Rule.

Concentrations for aluminum and zinc are projected to essentially remain unchanged, while concentrations for dissolved cadmium, dissolved copper, and dissolved lead concentrations are projected to increase. Loads for all metals are projected to increase because of the increased runoff volumes.

The important comparison with respect to potential effects on aquatic species is with the benchmark CTR criteria, and in the case of aluminum, the NAWQA criteria. Table 5-96 compares the projected mean concentration for wet years with the CTR and NAWQA benchmark criteria. A hardness of 120 mg/L has been used to estimate the CTR criteria of those metals whose criteria are hardness dependent. This value of hardness was the minimum hardness observed in the in-stream data collected at the four monitoring stations in the San Juan Creek watershed by Wildermuth. Therefore the criteria may be viewed as a lower bound, and in this respect the comparison is conservative (i.e., more likely to indicate an exceedance). The table indicates that the projected mean concentrations of all the metals are well below the minimum criteria. In conclusion, concentrations of all trace metals are projected to be at lower concentrations than the benchmark criteria.

**Table 5-94: Predicted Average Annual Trace Metal Loads for the Verdugo Sub-basin (Alternative B-9)(lbs)**

Modeled Area	Site Condition	Total Aluminum			Dissolved Cadmium			Dissolved Copper			Dissolved Lead			Dissolved Zinc		
		All Years	Dry Years	Wet Years	All Years	Dry Years	Wet Years	All Years	Dry Years	Wet Years	All Years	Dry Years	Wet Years	All Years	Dry Years	Wet Years
Verdugo Creek	Pre-Developed	52	10	141	0.04	0.01	0.10	0.38	0.07	1.04	0.10	0.02	0.26	2.8	0.5	7.6
	Developed	452	347	674	0.45	0.36	0.66	7.84	6.32	11.05	3.67	3.00	5.07	28.5	22.1	41.9
	Dev w/ PDFs	54	12	144	0.04	0.01	0.11	0.49	0.12	1.25	0.15	0.04	0.39	3.0	0.7	8.0
	Percent Change	4	21	2	10	33	7	27	69	20	60	141	48	7.1	26	4.2

**Table 5-95: Predicted Average Annual Trace Metal Concentrations for the Verdugo Sub-basin (Alternative B-9)(µg/L)**

Modeled Area	Site Condition	Total Aluminum			Dissolved Cadmium			Dissolved Copper			Dissolved Lead			Dissolved Zinc		
		All Years	Dry Years	Wet Years	All Years	Dry Years	Wet Years	All Years	Dry Years	Wet Years	All Years	Dry Years	Wet Years	All Years	Dry Years	Wet Years
Verdugo Creek	Pre-Develop	679	679	679	0.50	0.50	0.50	5	5	5	1.25	1.25	1.25	36.7	36.7	36.7
	Developed	565	557	574	0.57	0.57	0.56	10	10	9	4.58	4.82	4.32	35.6	35.5	35.7
	Dev w/ PDFs	658	641	661	0.51	0.52	0.51	6	7	6	1.86	2.36	1.77	36.5	36.4	36.6
	Percent Change	-3	-6	-3	2	4	2	18	32	15	49	89	42	-0.6	-1.0	-0.5

**Table 5-96: Comparison of Predicted Trace Metals Concentrations with Water Quality Criteria and Observed In-Stream Concentrations for the Gabino Sub-basin (Alternative B-4)**

Trace Metals	Predicted Average Annual Concentration <sup>1</sup> (µg/L)			California Toxics Rule Criteria <sup>2</sup> (µg/L)	Observed Range of In-Stream Concentrations <sup>3</sup> (µg/L)
	All Years	Dry Years	Wet Years		
Total Aluminum	658	641	661	750 <sup>4</sup>	Not Monitored
Dissolved Cadmium	0.51	0.52	0.51	5.2	None Detected – 0.09
Dissolved Copper	6	7	6	15.9	2.1 – 4.0
Dissolved Lead	1.86	2.36	1.77	78.7	None Detected – 3.9
Dissolved Zinc	36.5	36.4	36.6	137	None Detected – 15.0

<sup>1</sup>Modeled concentration for developed conditions with PDFs.

<sup>2</sup>Hardness = 120 mg/L, minimum value of monitoring data.

<sup>3</sup>Range of means observed at four San Juan watershed stations during storm events.

<sup>4</sup>NAWQC criteria for pH 6.5 – 9.0.

### **5.8.5 Findings of Significance**

The following findings of significance refer to Alternative B-9. The findings for the B-4 alternative are stated in Section 5.8.1 above.

#### *Hydrologic Conditions of Concern and Significance Thresholds*

The following discusses the implications of the water balance results on the hydrologic conditions of concern.

##### 1. Increased Stormwater Runoff Flowrate, Volume and Flow Duration

Significance Threshold A: Substantially alter the existing drainage pattern of the site or area, including alteration of the course of a stream or river, in a manner that would cause substantial erosion or siltation.

The WQMP was designed specifically to preserve and protect the existing drainage patterns, and sediment transport regime.

Significance Threshold B: Substantially increase the frequencies and duration of channel adjusting flows.

Runoff volume in lower Verdugo is not projected to increase substantially with the proposed development, in large part because of the effectiveness of the combined control system.

On this basis, the effect of the proposed development on altering existing drainage or increasing the frequency and duration of channel adjusting flows is determined to be less than significant.

## 2. Decreased Infiltration and Groundwater Recharge

Significance Threshold A: Substantially deplete groundwater supplies or interfere substantially with groundwater recharge that would cause a net deficit in aquifer volumes or lowering of the local groundwater table.

Groundwater outflow is projected to increase approximately 85 percent due to the use of infiltration and the added irrigation volumes. These projected changes in groundwater outflow indicate that groundwater infiltration and groundwater recharge will not be decreased by the proposed development in this sub-basin.

On this basis, the potential effect of the proposed development on infiltration and groundwater recharge are considered less than significant.

## 3. Changed Base Flows

Significance Threshold A: Substantially increase or decrease base flows as to negatively impact riparian habitat.

The increased availability of groundwater could encourage non-native vegetation or additional vegetation that could adversely affect aquatic species. However it is likely that riparian vegetation in lower Verdugo is influenced more by channel scour than by groundwater level. If elevated groundwater conditions in lower Verdugo were to adversely affect habitat, adaptive management options could include pumping the aquifer down each year in order to manage base flows for the maximum habitat value.

Significance Threshold B: Substantially increase or decrease low flow estimates where high groundwater elevations are considered important.

The water balance analysis indicates that post-development groundwater outflow will increase by about 85 percent for all years and about 127 percent during dry years. This groundwater outflow would ultimately increase base flows in Verdugo Creek, which would be utilized to support riparian vegetation, increase levels of the water table, or infiltrate into the channel bottom.

On this basis, the effect of the proposed development in altering base flows such as to adversely affect habitat or groundwater levels is considered less than significant.

### *Pollutants of Concern*

The following are the conclusions regarding the significance of impacts for the pollutants of concern under wet and dry weather conditions.

*Sediments:* Mean total suspended solids concentrations and loads are predicted to be less in the post-development condition. Because development will be located in areas with clay soils, the generation of fine sediments that originate from erosion of these clay soils will be reduced, whereas the transport of coarser sediment and cobbles generated in upper Verdugo Canyon will be maintained to and through lower Verdugo Creek.

*Nutrients (Nitrogen and Phosphorous):* Nitrate-nitrogen concentrations are projected to decrease with development; however, TKN and total phosphorus concentrations are projected to increase. Loads of all three nutrient species are projected to increase. Comparisons with observed in-stream data indicate runoff nitrate-nitrogen concentrations will be comparable to observed in-stream concentrations. Also, as discussed earlier, the utilization of constructed wetlands for treatment has been shown to be effective in reducing nutrient concentrations. Given that nitrate-nitrogen is the more important nutrient of concern, this comparison would suggest that runoff would not increase algal growth in Verdugo Creek or impact arroyo toad habitat. Moreover, as also discussed earlier, intermittent streams run during the wet winter and spring season when environmental conditions of light and temperature are less supportive of algal growth.

*Trace Metals:* Although trace metal loads are projected to increase, mean concentrations of cadmium, copper, lead, and zinc are well below the benchmark CTR criteria. Total aluminum is also less than the benchmark NAWQA criterion for all climatic conditions.

On this basis, the impact of the B-4 alternative on sediments, nutrients, and trace metals in the Gabino Sub-basin is considered less than significant.

## **5.9 IMPACT ANALYSIS FOR THE NARROW AND LOWER CENTRAL SAN JUAN SUB-BASIN AND THE LOWER CRISTIANITOS SUB-BASIN**

Hydrologic and water quality modeling was conducted for most of the Planning Areas and the results of this modeling was presented in the sections above. This modeling encompassed the range of terrains and proposed development types in the proposed alternatives, and therefore it was not necessary to model all of the planning areas. The two remaining sub-basins that were not modeled were: (1) the Narrow and Lower Central San Juan Sub-basin (areas affected by PA 1), and lower Cristianitos Sub-basin, which would be affected by proposed development in the extreme western portion of the Northrop-Grumman area development (PA 8).

### **5.9.1 Narrow and Lower San Juan Sub-basin**

Planning Area (PA) 1 is located in the western portion of Narrow Canyon within the Chiquita Sub-basin and in what is referred to herein as the Lower Central San Juan Sub-basin. The proposed development in both the B-4 and B-9 alternatives would encompass approximately 599 acres and provides a mix of residential, urban activity center, business park, and open space uses. Runoff from PA 1 would discharge into San Juan Creek. The following impact analysis is for both development alternatives.

#### ***Impacts on Hydrologic Conditions of Concern***

Effects on the hydrologic conditions of concern are associated with increased runoff volumes, peak flows, and durations taking into account the effect of terrains on stream channel characteristics and sediment supply. PA 1 is located in clayey terrain where shallow substrate is classified as less erodible clay. This terrain is also characterized as having lower infiltration capacity and therefore the effects of development on increasing runoff will be less pronounced than comparable development on sandy soils.

The receiving stream is San Juan Creek, a braided stream that drains a large tributary area. The system is braided because coarser sediments that originate in the steeper upland portions of the watershed tend to be deposited in the more gradual reach within PA 1. Given the small size of PA 1 compared to the San Juan Creek watershed, the discharges from PA 1 will in general be small relative to existing flow conditions in San Juan Creek. Also, given the proximity of the planning area to the creek and the tendency of urbanization to decrease the response time of catchments, the discharges from PA 1 will tend to precede peak flows in the larger watershed. For small storms, discharges into San Juan Creek may only originate from urbanized areas; however, such discharges will easily be accommodated within the channel and are not likely to be sufficient to mobilize stream sediments on a large scale.

With respect to significance criteria, discharges from the proposed development are not likely to adversely affect storm flows or base flows to the extent that the geomorphology and habitat values of central San Juan Creek will be adversely affected. Groundwater recharge also will not be significantly affected given the clayey terrain which limits existing infiltration.

#### ***Impacts on Pollutants of Concern***

Impacts on pollutants for this development area are addressed based on available runoff data from similar land uses and data on BMP effectiveness. Table 5-97 shows the anticipated runoff water quality and effectiveness of the treatment BMPs based on literature values. The table is limited to solids, nutrients, and trace metals, as these categories of pollutants are most often measured in stormwater monitoring programs. Project impacts on pathogens, petroleum hydrocarbons, pesticides, trash and debris, and chlorine were addressed qualitatively in Section 5-1. Monitoring data from a nearby station in San Juan Creek are also provided, and, where applicable, available water quality criteria are given.

It is important to note that, as indicated in the table, the runoff data are regional data from LA and Ventura Counties, whereas the treatment data come from the EPA International BMP Database. Given the current availability of data, these are considered the two best sources of information for the project. However, using independent data sets can lead to minor inconsistencies. For example, in some cases effluent quality exceeds runoff water quality. Also within the ASCE/EPA data set, each constituent is not measured at all facilities and for all storms and this may lead to inconsistencies. For example, the dissolved copper concentration exceeds the total copper value in the data set. These inconsistencies reflect the current availability of data, but are minor for our broader purposes here and do not affect our conclusions.

Dissolved metals data are all well below the CTR criteria based on hardness values observed in San Juan Creek. Also, note that dissolved concentrations observed in San Juan Creek are less than the effluent quality predictions. This reflects the much higher TSS concentrations in San Juan Creek, which tends to increase the fraction of metals adsorbed to particulates and decrease the fraction of metals in the dissolved state.

Although there are no numeric water quality criteria for nutrients, projected effluent concentrations of nutrients are all relatively low when compared to the range of observed concentrations. The projected effluent concentrations for the more biologically available forms of the nutrients, namely dissolved phosphorous and nitrate-nitrogen are below the observed range.

Total suspended solids are projected to be relatively low compared to the range of observed data, which reflects in part the high sediment concentrations that can be observed during large storm events in the San Juan Creek watershed. This comparison does not account for grain size, for which the terrain analysis would indicate that discharges from PA 1 will tend to be finer material such as clays and silts. In contrast, sediment supply and transport energy in the San Juan Creek watershed as a whole indicate that suspended sediments will largely be coarser materials, including sands.

With respect to significance criteria for water quality, these data indicate that, with implementation of the proposed WQMP, projected mean concentrations in the runoff discharged to San Juan Creek will not exceed water quality criteria, and will in general be less than observed in San Juan Creek. On this basis, the effects of discharges from PA 1 on water quality in San Juan Creek are considered less than significant.



**Table 5-97: Projected Runoff Water Quality for Mixed Residential Land Uses in Planning Area 1**

Pollutant of Concern	Units	Predicted Runoff Quality <sup>1</sup>	Predicted Effluent Quality <sup>2</sup>	Range of Observed Concentrations <sup>3</sup>	CTR Criteria <sup>4</sup>
TSS	mg/L	72.9	33.7	13 - 3100	
Nitrate-Nitrogen	mg/L	0.59	0.29	0.46 - 1.5	
Total Kjeldahl Nitrogen	mg/L	2.2	1.6	0.56 – 2.8	
Dissolved Phosphorus	mg/L	0.23	0.15	0.54 - 0.76	
Total Phosphorus	mg/L	0.28	0.26	0.07 - 1.5	
Total Aluminum	µg/L	278	NA	NA	750
Total Cadmium	µg/L	NA	0.93	ND <sup>6</sup> – 9.1	
Dissolved Cadmium	µg/L	0.12	0.52	ND - 0.088	7.6
Total Copper	µg/L	13.5	14.2	ND - 90	
Dissolved Copper	µg/L	8.60	16.2	3.4 - 3.7	22.2
Total Lead	µg/L	5.22	18.8	ND - 22	
Dissolved Lead	µg/L	1.60	2.58	ND	115
Total Zinc	µg/L	134	77.8	36 - 360	
Dissolved Zinc	µg/L	98.2	54.7	ND -13	184

<sup>1</sup>Predicted mean runoff quality based on LA County EMC data for mixed residential land use type. Range of data points for monitored parameters is 49 to 56

<sup>2</sup>Predicted mean effluent quality based on ASCE/EPA International BMP Database for extended detention basin. Range of data points for monitored parameters is 12 to 104

<sup>3</sup>Range of observed concentrations at station SW1 (San Juan at Equestrian Site). Number of data points for monitored parameters is 2 to 5

<sup>4</sup>CTR Criteria were conservatively estimated based on minimum hardness value (170 mg/L as CaCO<sub>3</sub>) observed at the station SW1 (San Juan at Equestrian Site)

<sup>5</sup>NA – Not Available

<sup>6</sup>ND – Non-Detect

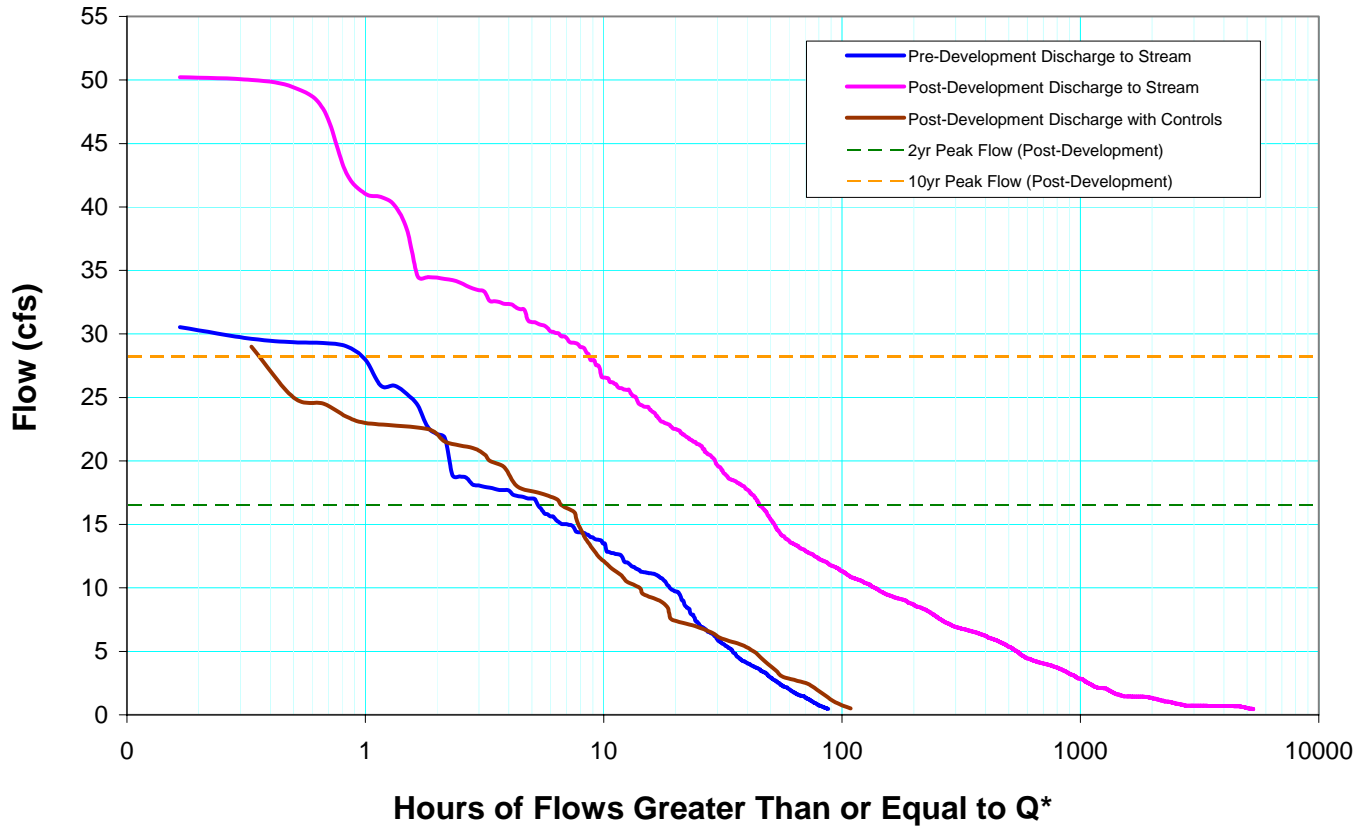
### **5.9.2 Lower Cristianitos Sub-basin**

Alternative B-4 proposes 140 acres of general development, five acres of non-reserve open space, and 144 acres of reserve open space within the Lower Cristianitos Sub-basin. The general development land use is associated with Planning Area 8, which overlays the Lower Cristianitos, Gabino, Blind, and Talega sub-basins. Grading plans for the B-4 alternative would redirect

approximately 40 acres of the Lower Cristianitos Sub-basin into the Talega Sub-basin and would redirect approximately three acres of the Blind Sub-basin into the Lower Cristianitos Sub-basin, for a net gain of 37 acres in Lower Cristianitos.

Alternative B-9 includes 32 acres of general development, 55 acres of non-reserve open space, and 200 acres of reserve open space within the Lower Cristianitos Sub-basin. The anticipated increase in runoff volumes, especially low flows, would likely infiltrate into Lower Cristianitos Creek, raise groundwater levels, and support riparian vegetation. Runoff volumes and flow rates associated with larger storm events are not likely to adversely affect the stability of Lower Cristianitos Creek given the size of the proposed development relative to the size of the overall San Mateo Creek watershed at the point of discharge. Prior to discharge, runoff would be treated in an extended detention basin following the WEF sizing methodology.

## Cumulative Frequency Distribution



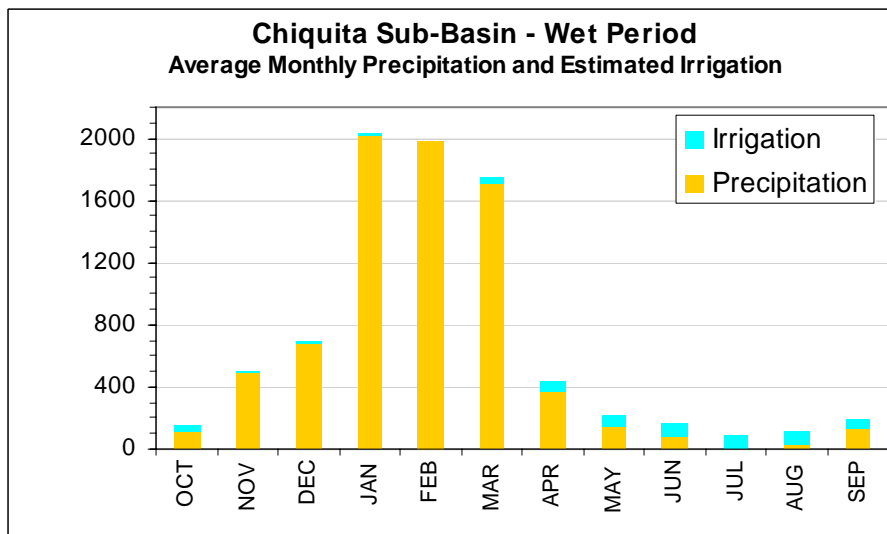
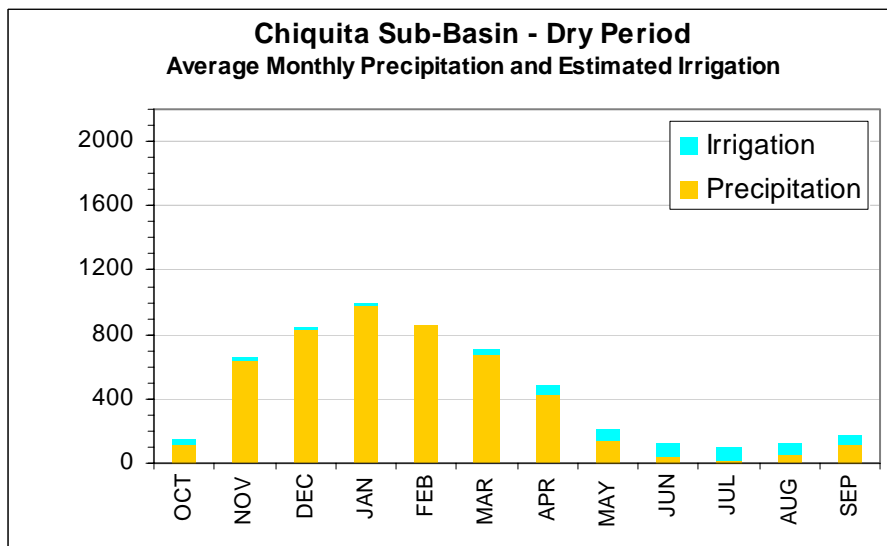
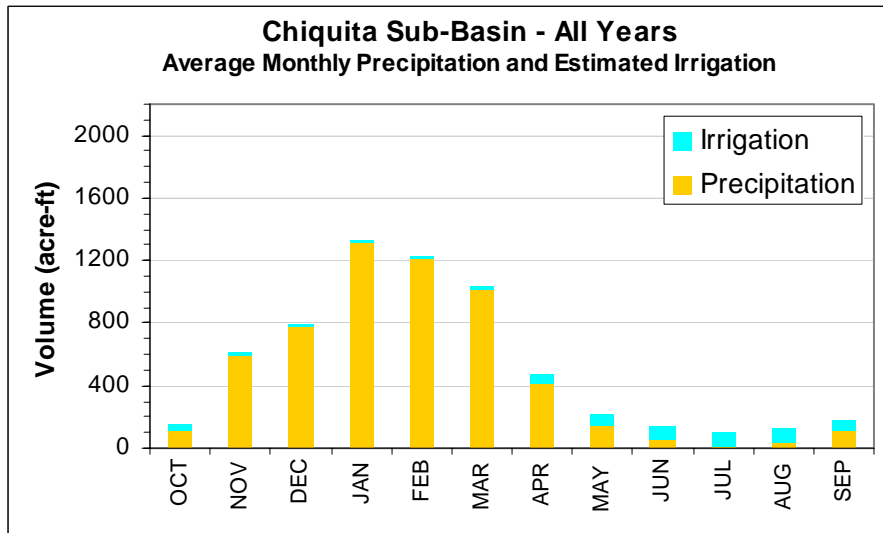
\* for 53 years of rainfall record; Water Years 1949-2001

**Figure 5-1**  
**Flow Duration Curves for Cañada Chiquita- Catchment 13**

March 2004

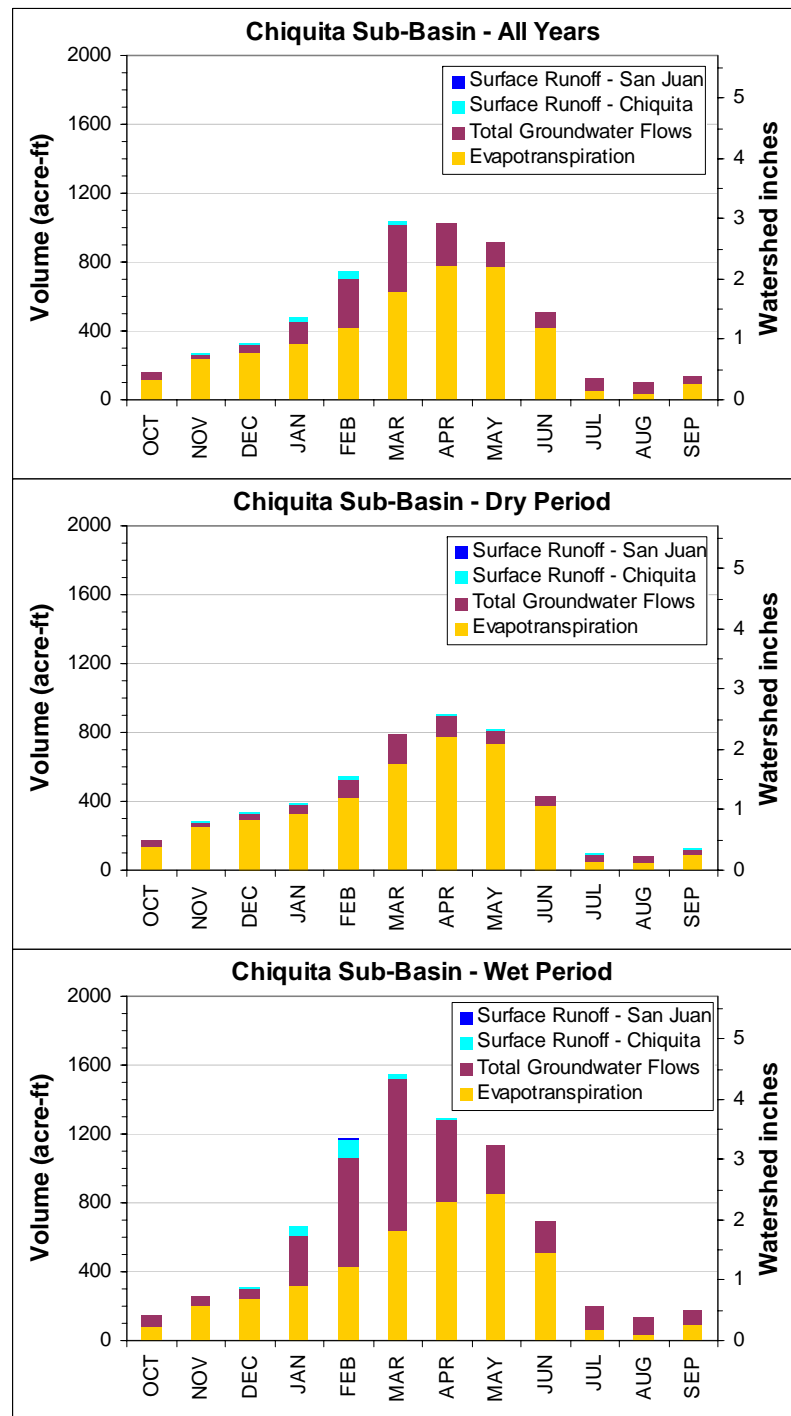
Water Quality Management Plan  
Rancho Mission Viejo



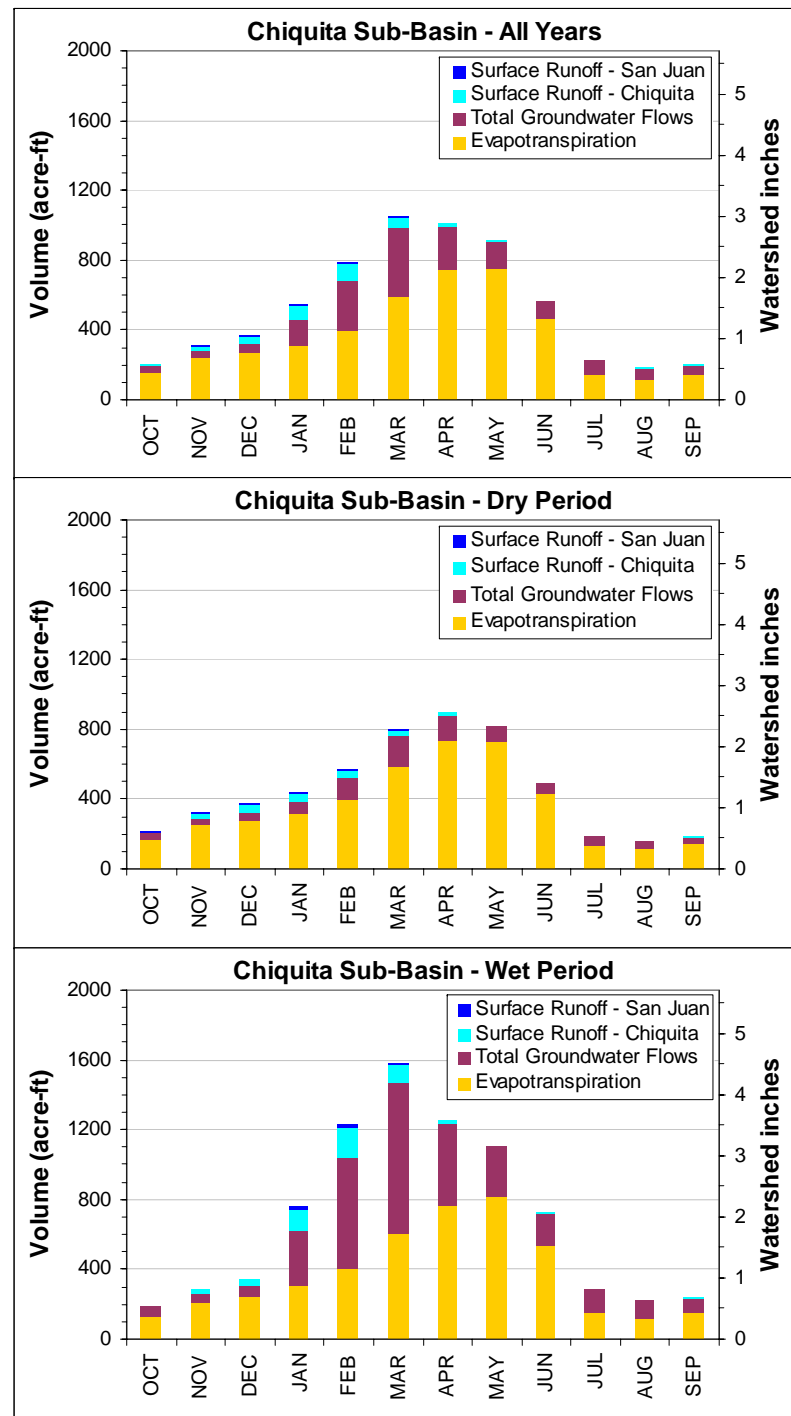


**Figure 5-2**  
**Comparison of Average Monthly Precipitation for Cañada Chiquita**

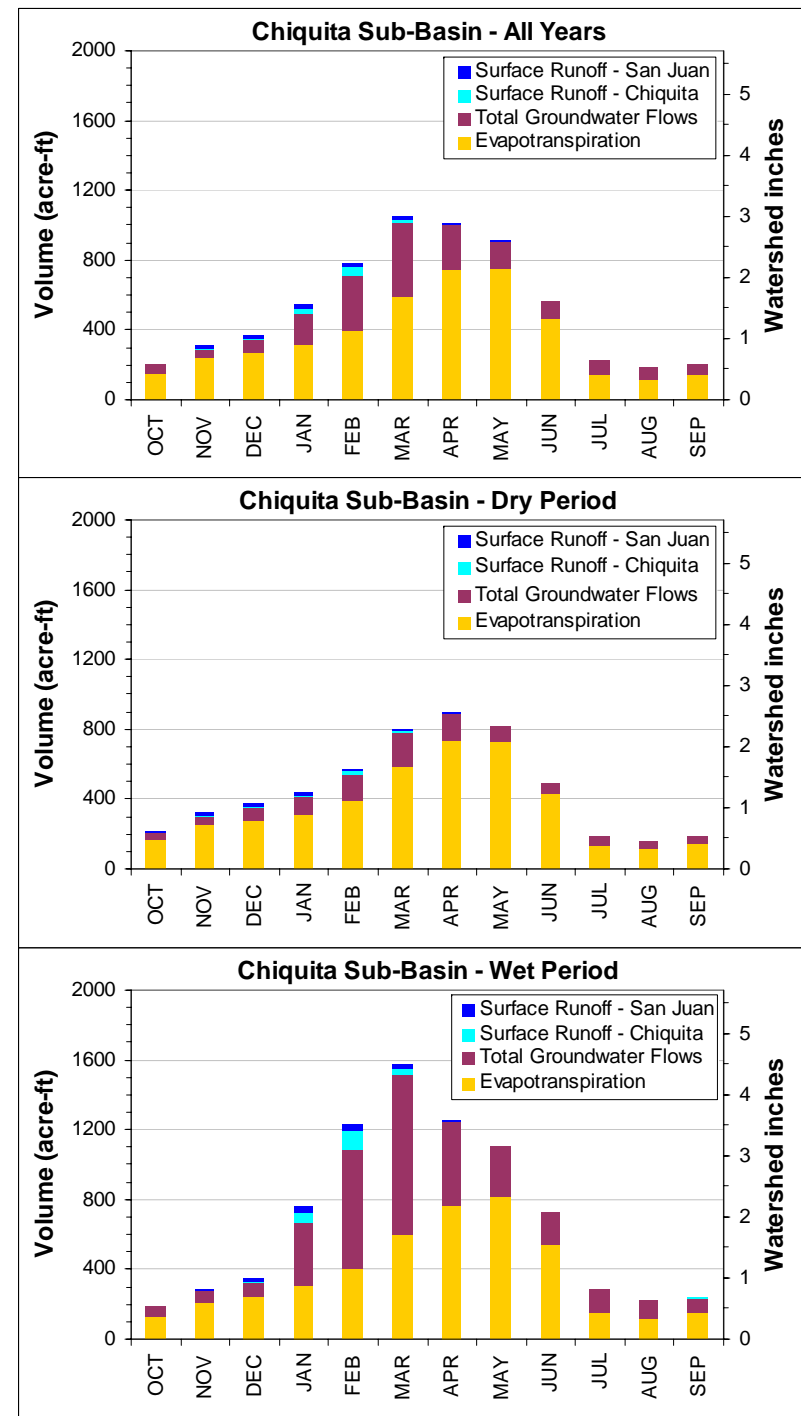
## Pre-Development



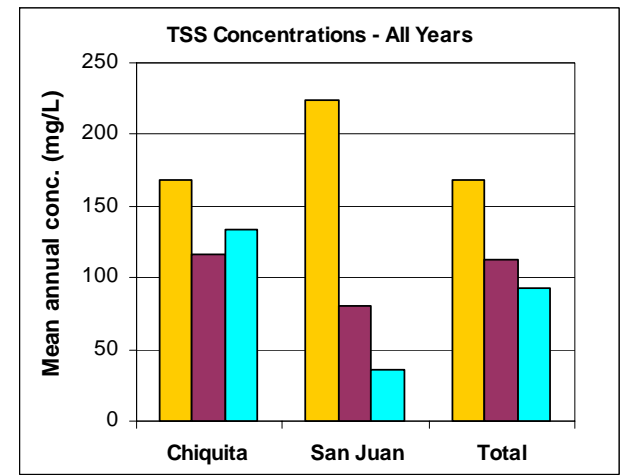
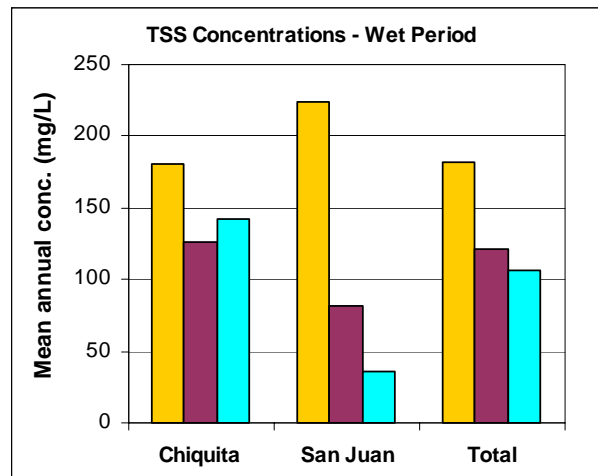
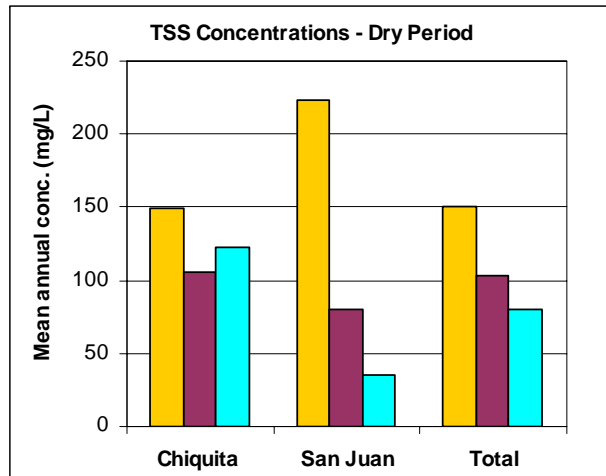
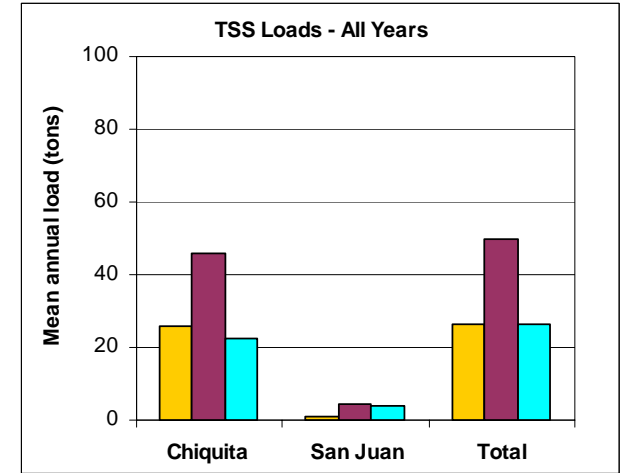
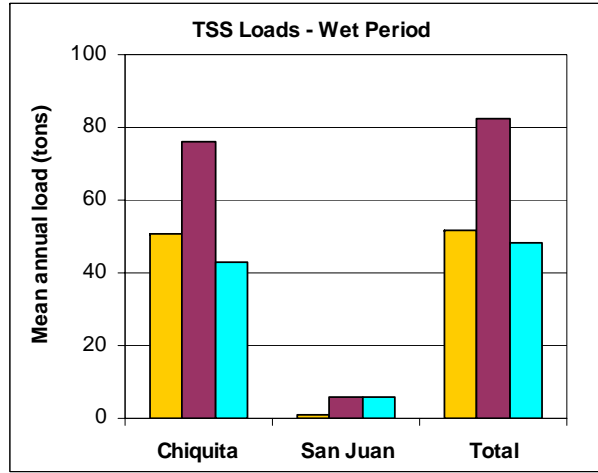
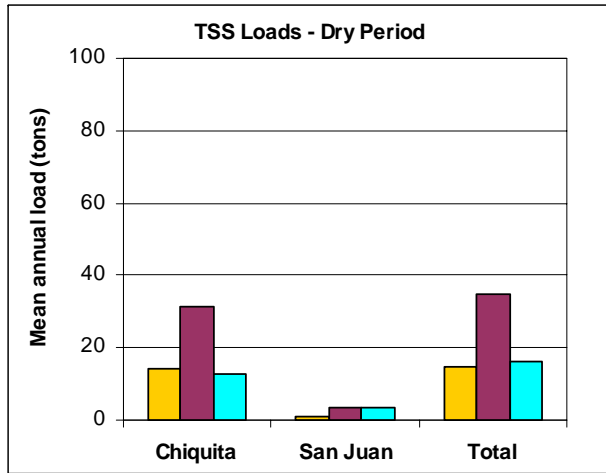
## Post-Development, No BMPs



## Post-Development, With BMPs

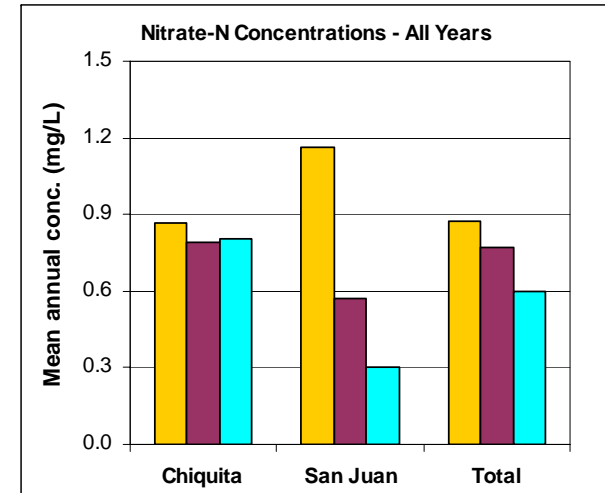
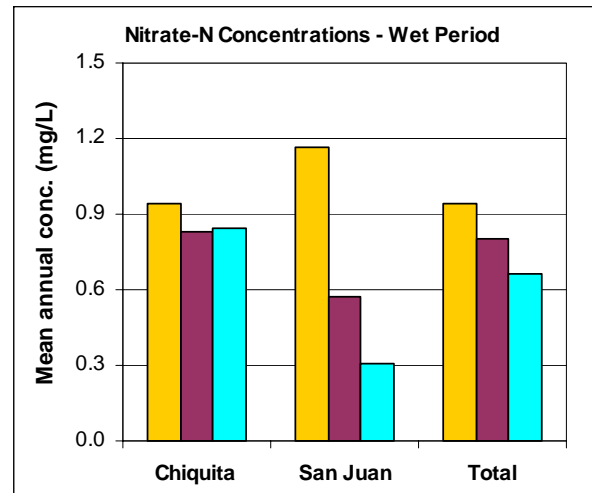
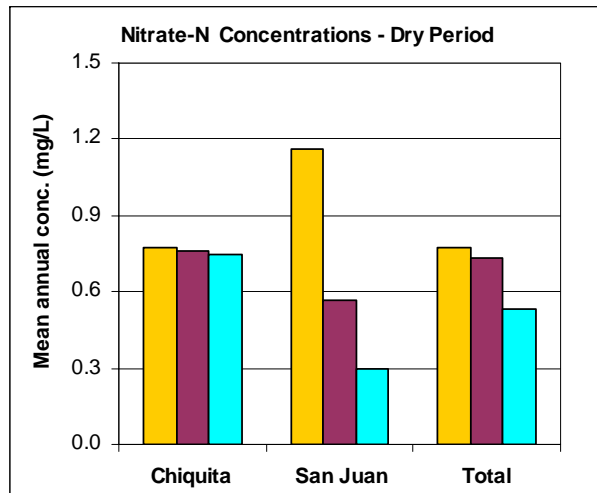
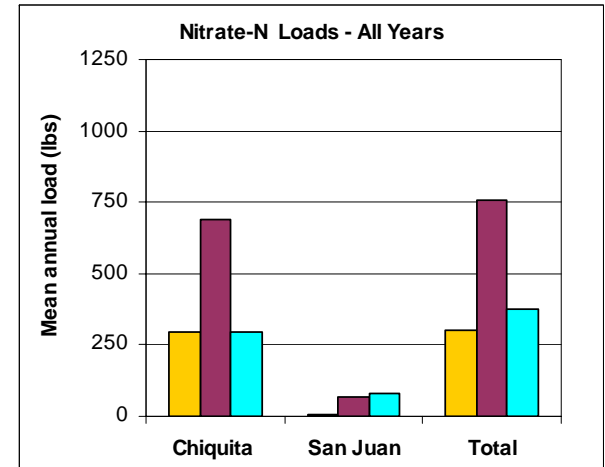
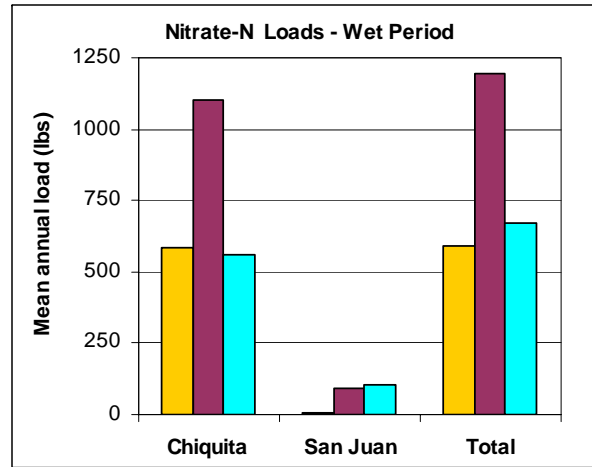
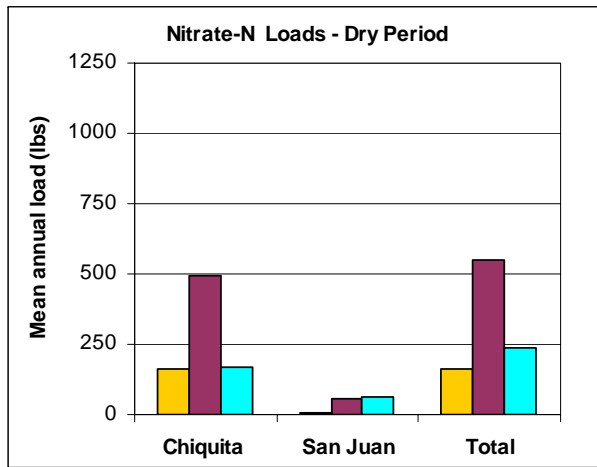


**Figure 5-3**  
Water Balance Results for the Cañada Chiquita Sub-basin



- Existing
- Post- Developed
- Post- Developed w/ BMPs

**Figure 5-4**  
**Predicted Average Annual TSS Loads and Concentrations for Cañada Chiquita**



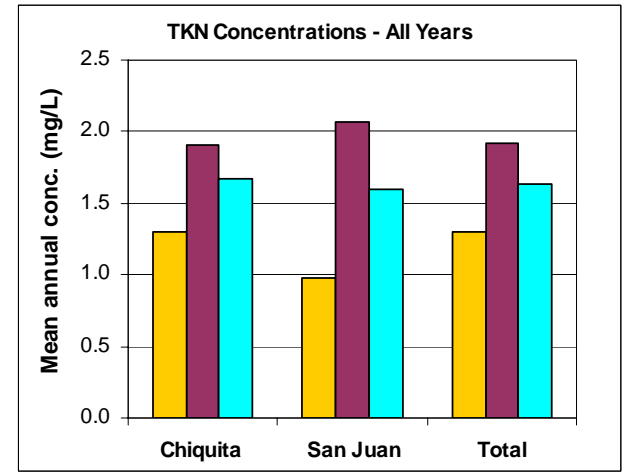
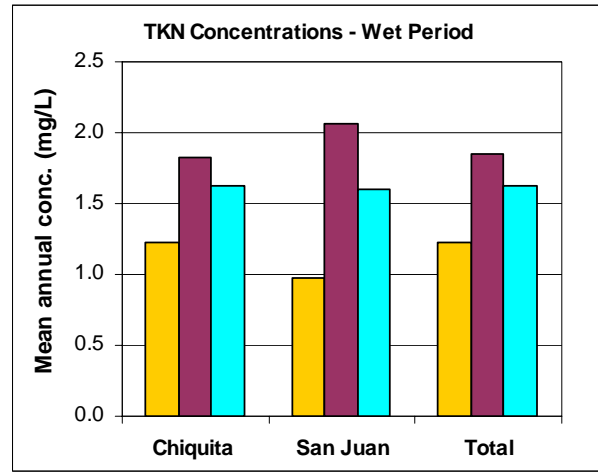
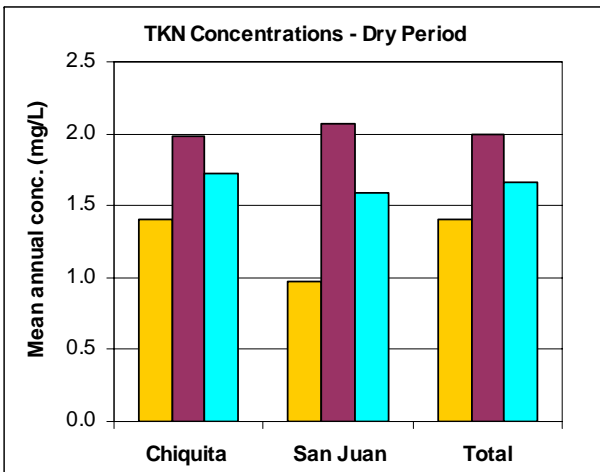
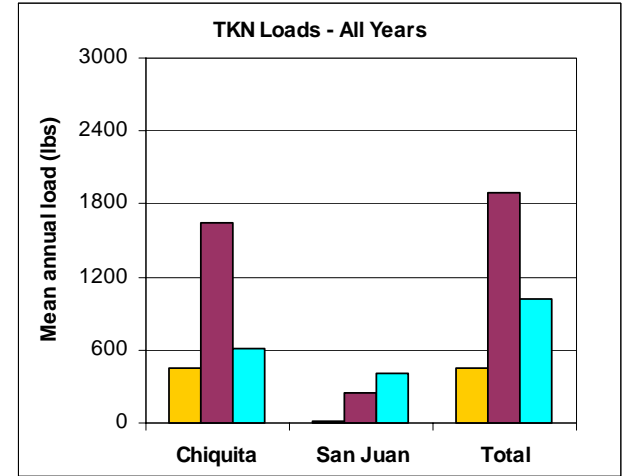
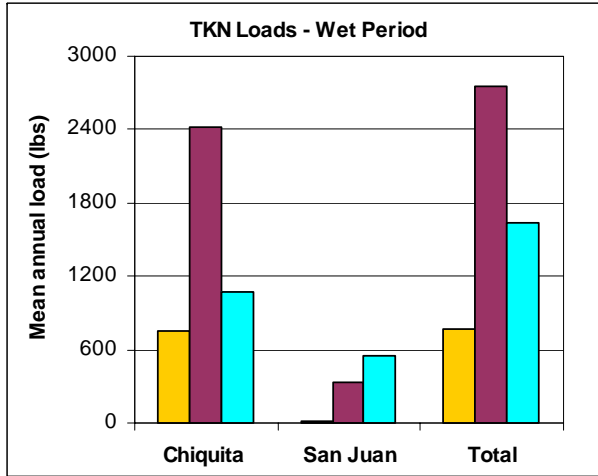
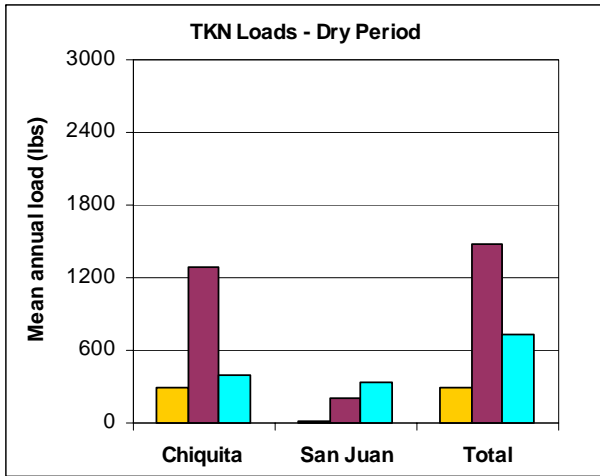
■ Existing  
■ Post- Developed  
■ Post- Developed w/ BMPs

**Figure 5-5**  
**Predicted Average Annual Nitrate-N Loads and Concentrations for Cañada Chiquita**

March 2004

Water Quality Management Plan  
 Rancho Mission Viejo

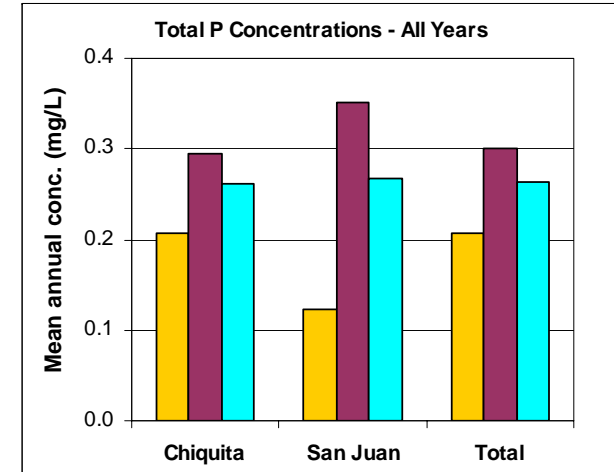
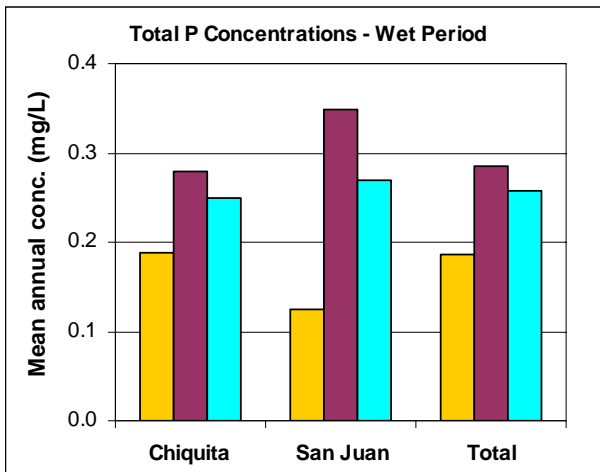
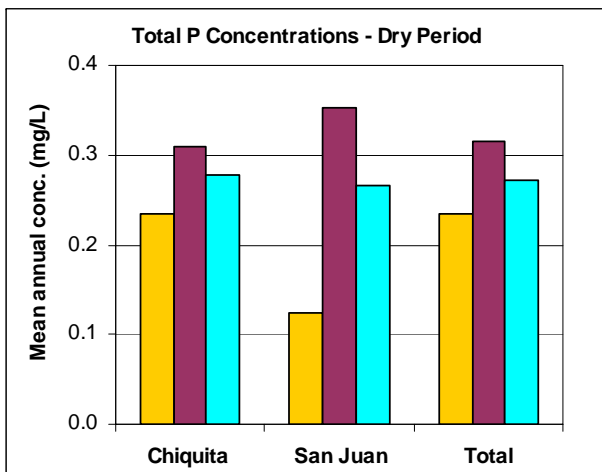
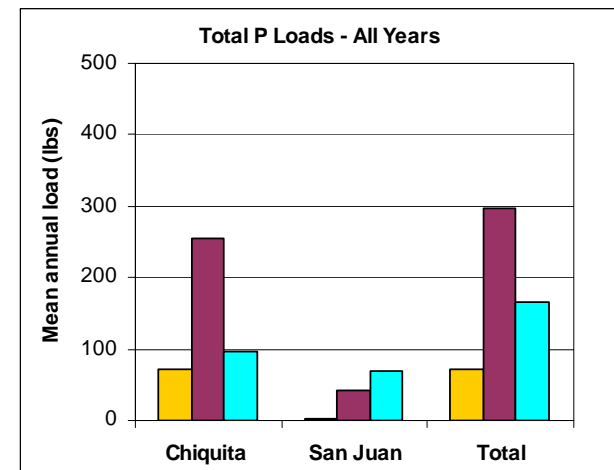
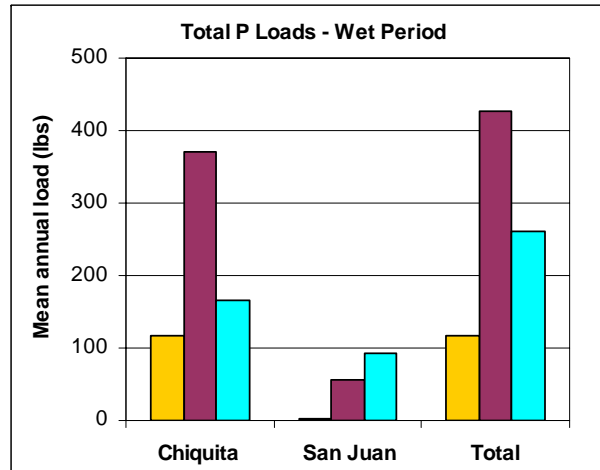
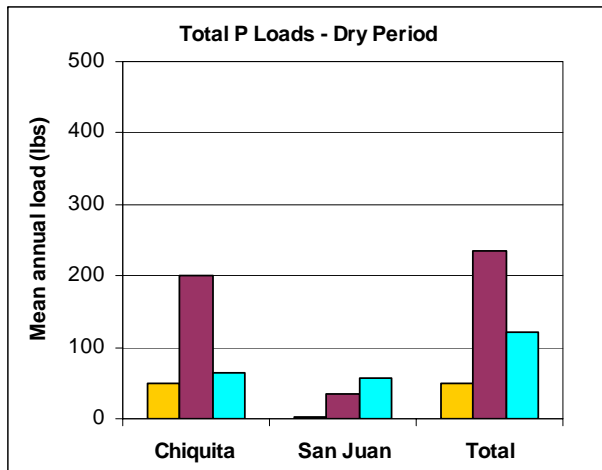




- Existing
- Post- Developed
- Post- Developed w/ BMPs

**Figure 5-6**  
**Predicted Average Annual TKN Loads and Concentrations for Cañada Chiquita**





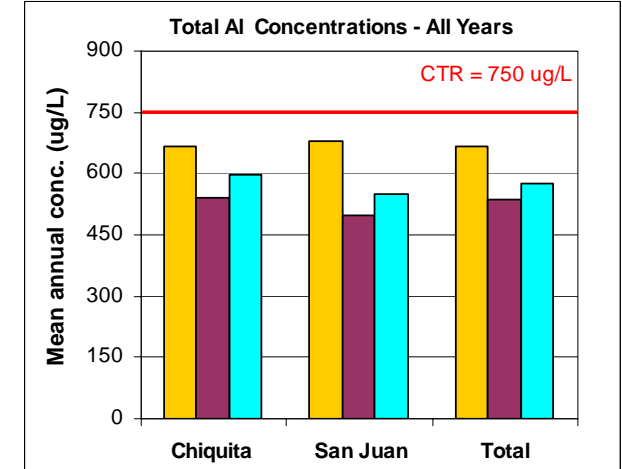
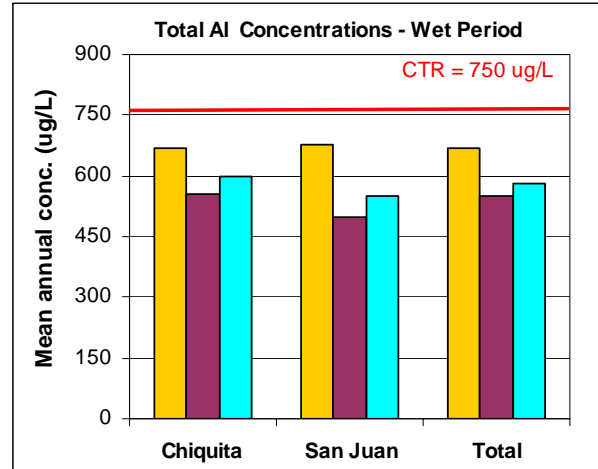
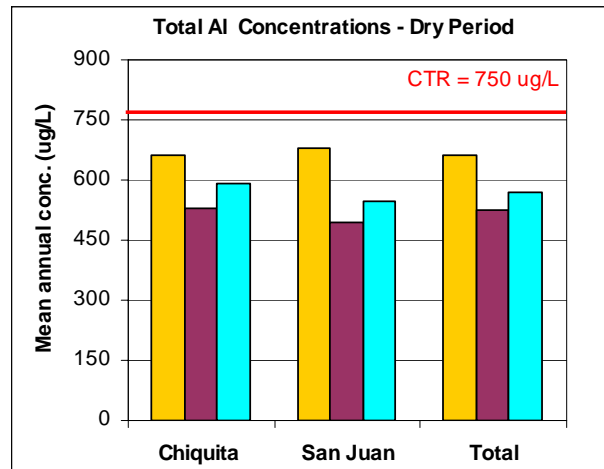
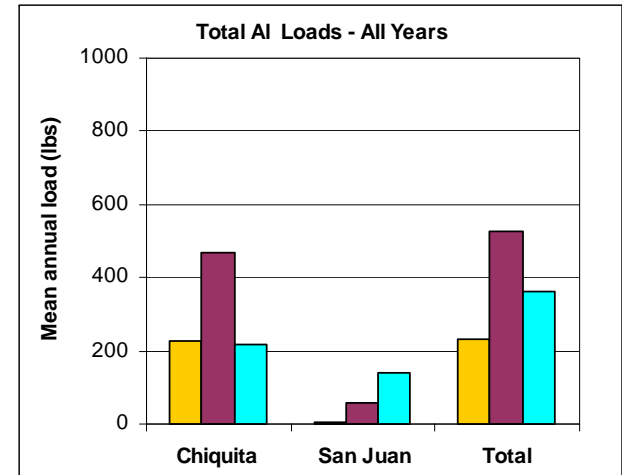
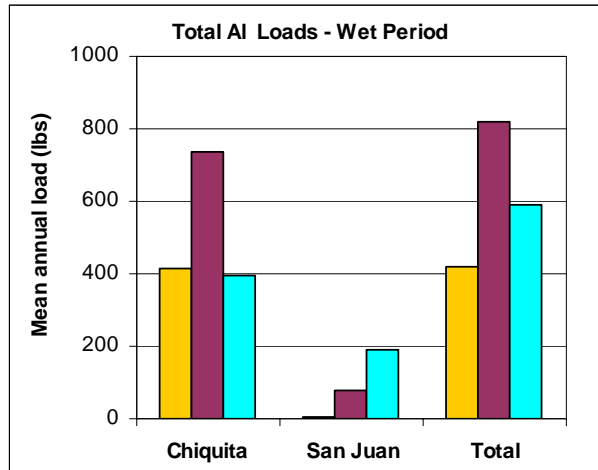
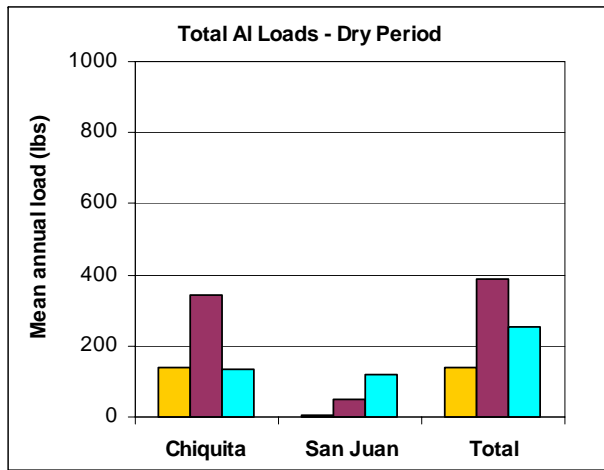
- Existing
- Post- Developed
- Post- Developed w/ BMPs

**Figure 5-7**  
**Predicted Average Annual Total Phosphorous Loads and Concentrations for Cañada Chiquita**

March 2004

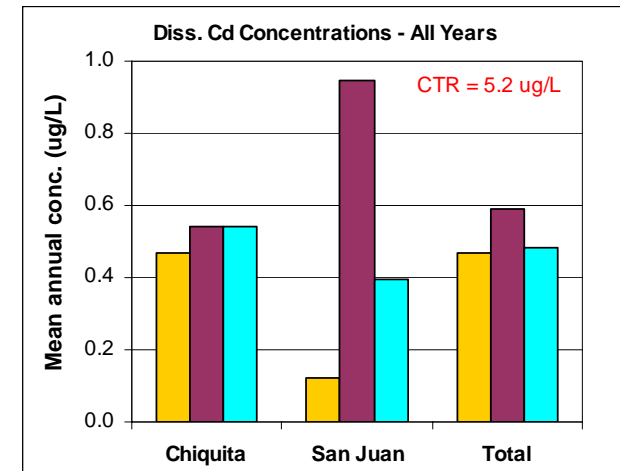
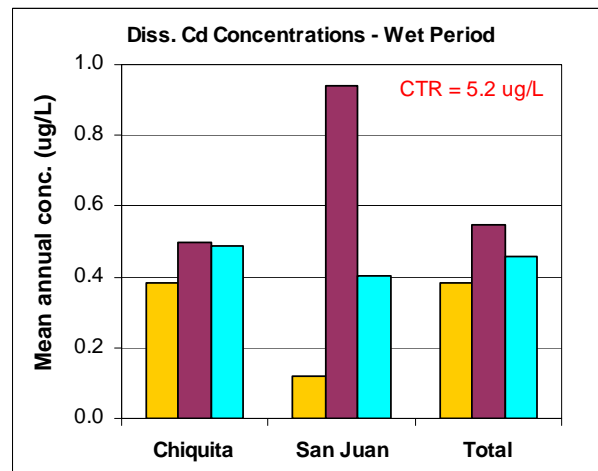
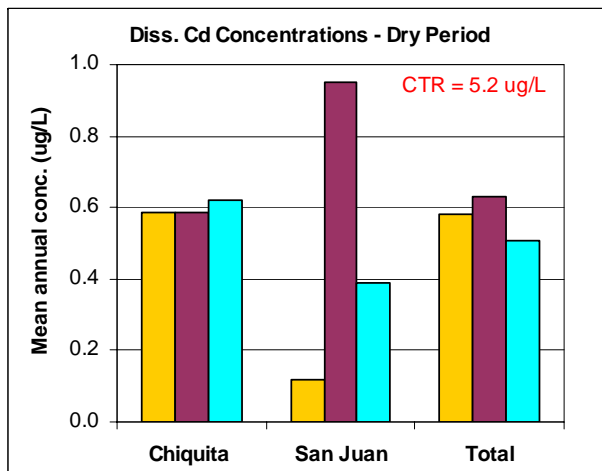
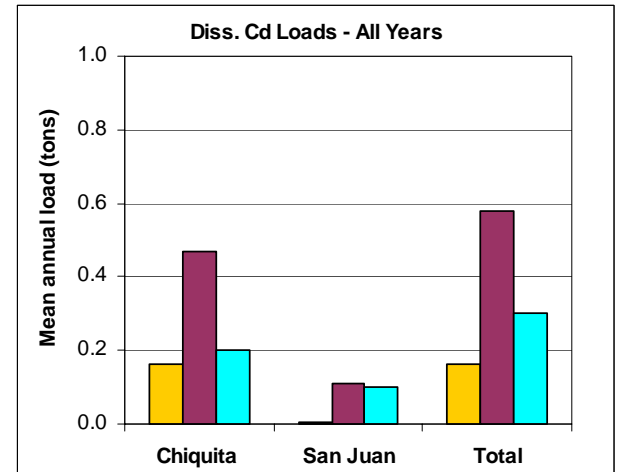
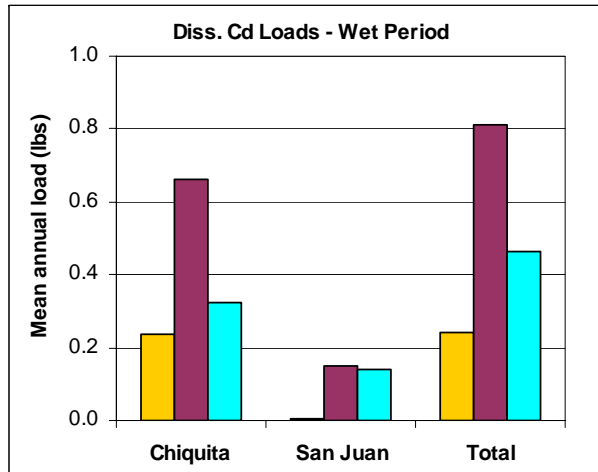
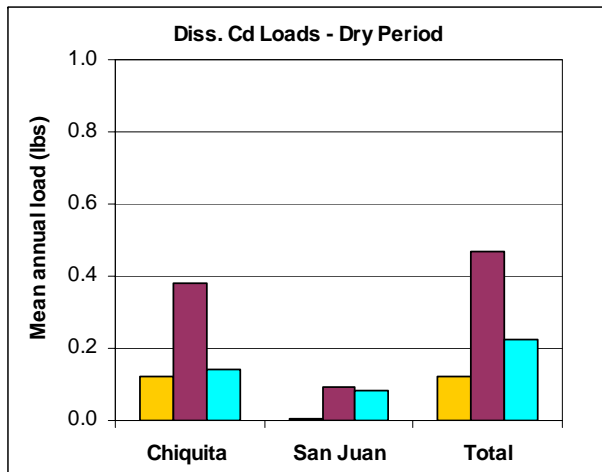
**Water Quality Management Plan**  
**Rancho Mission Viejo**





- Existing
- Post- Developed
- Post- Developed w/ BMPs

**Figure 5-8**  
**Predicted Average Annual Total Aluminum Loads and Concentrations for Cañada Chiquita**



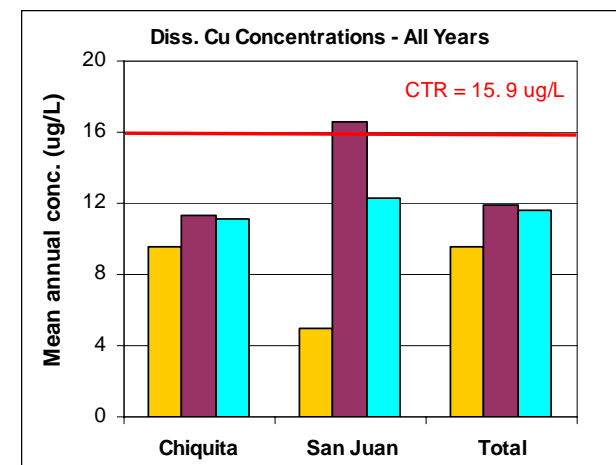
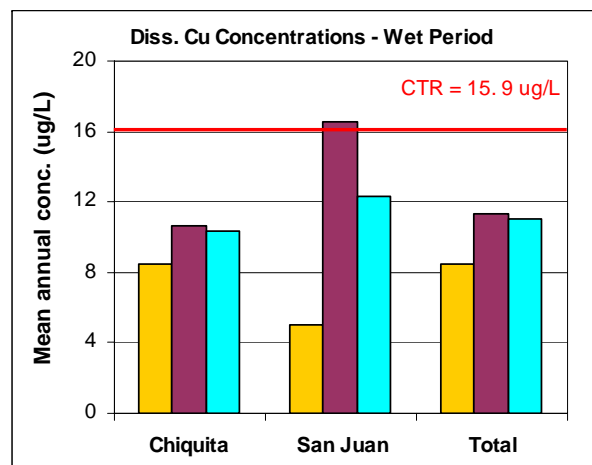
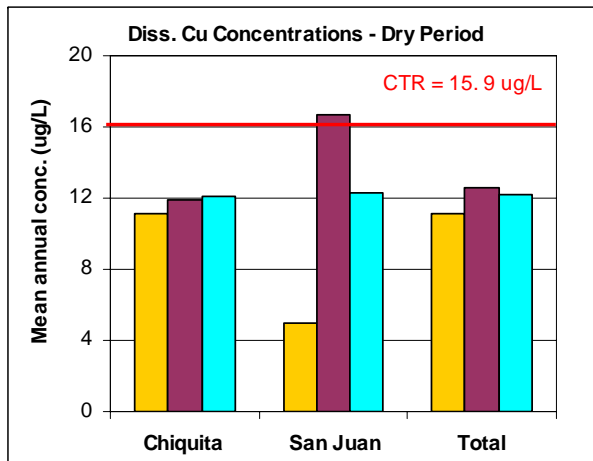
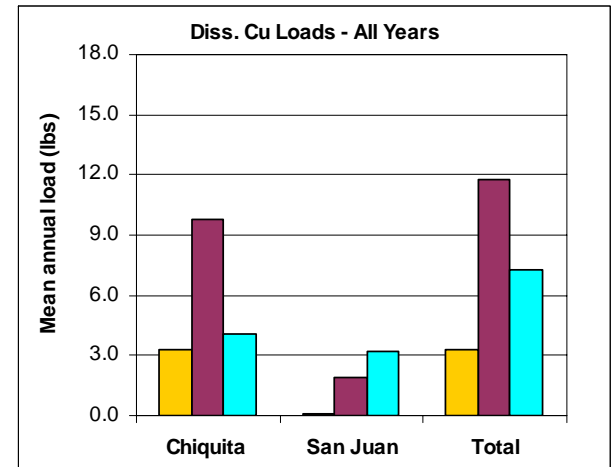
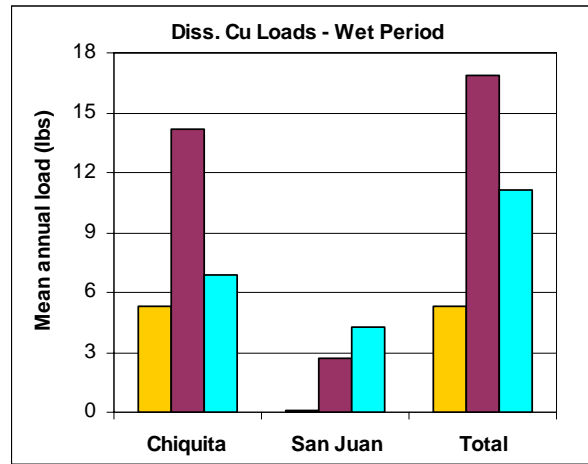
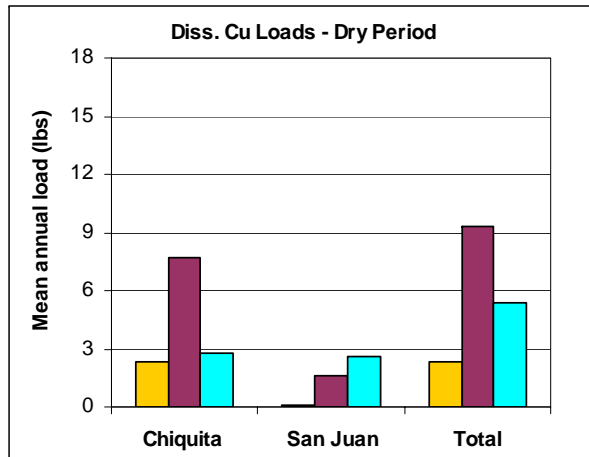
■ Existing  
■ Post- Developed  
■ Post- Developed w/ BMPs

**Figure 5-9**  
**Predicted Average Annual Dissolved Cadmium Loads and Concentrations for Cañada Chiquita**

March 2004

Water Quality Management Plan  
 Rancho Mission Viejo





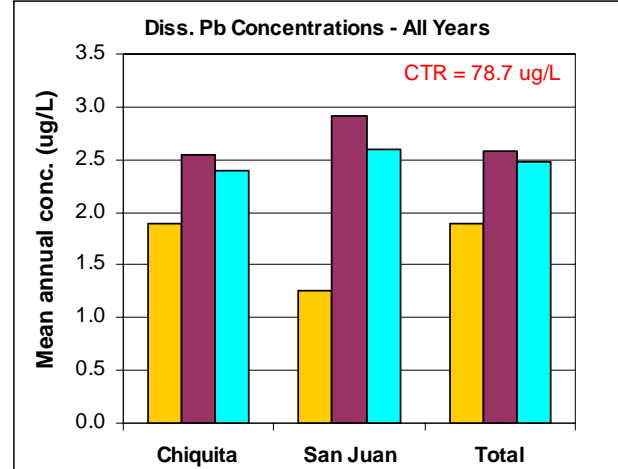
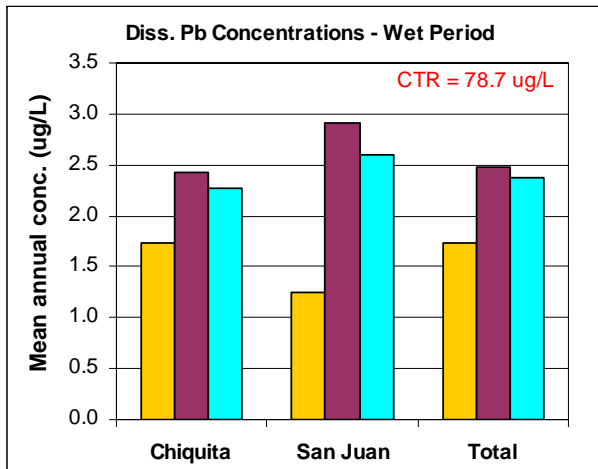
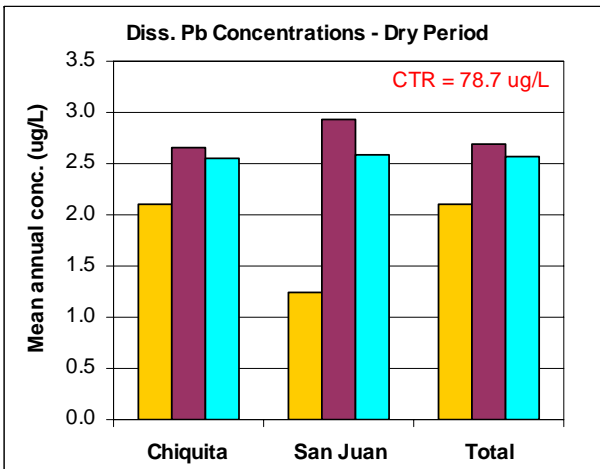
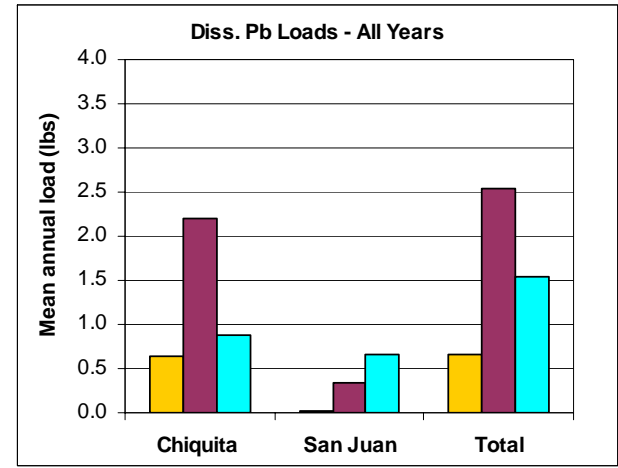
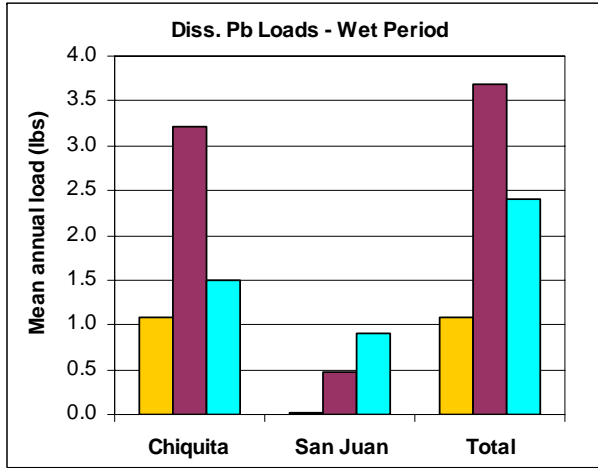
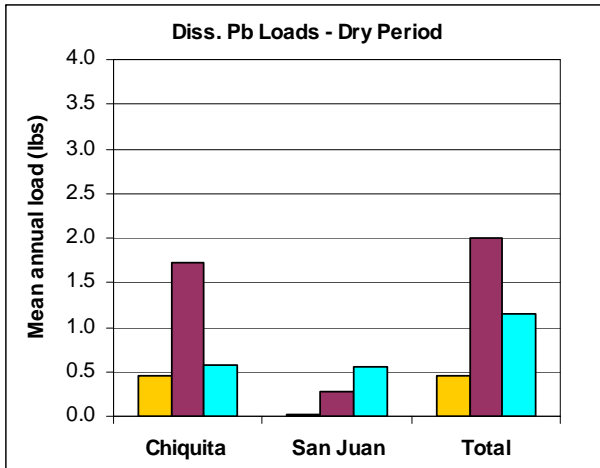
- Existing
- Post- Developed
- Post- Developed w/ BMPs

**Figure 5-10**  
**Predicted Average Annual Dissolved Copper Loads and Concentrations for Cañada Chiquita**

March 2004

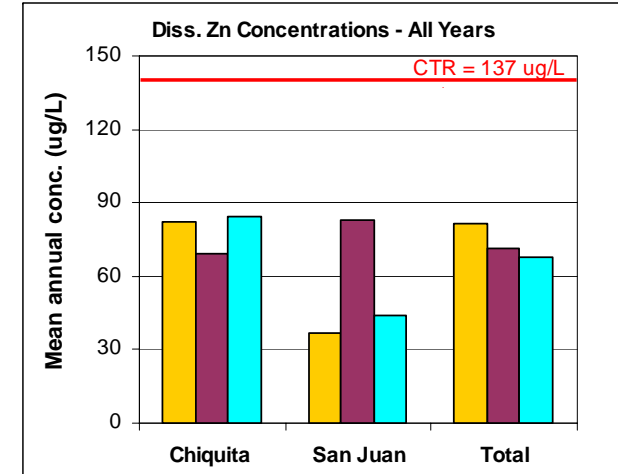
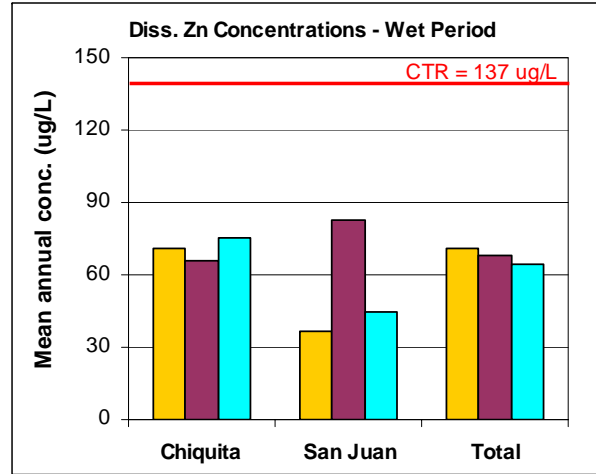
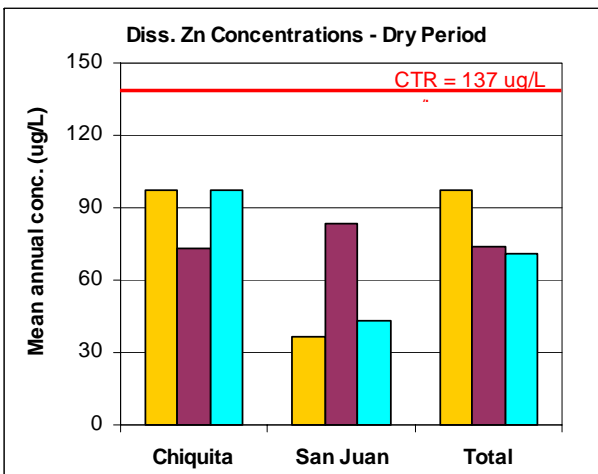
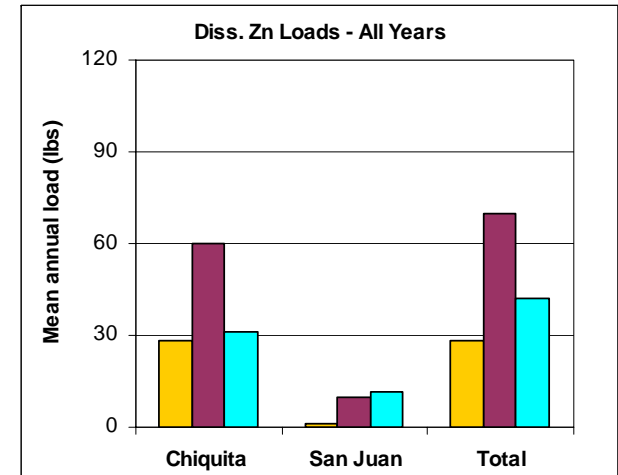
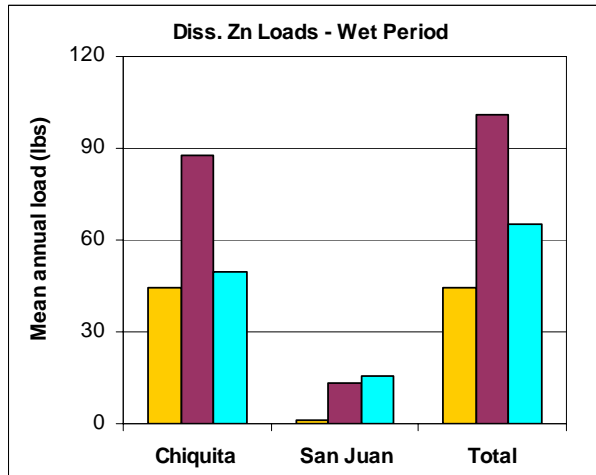
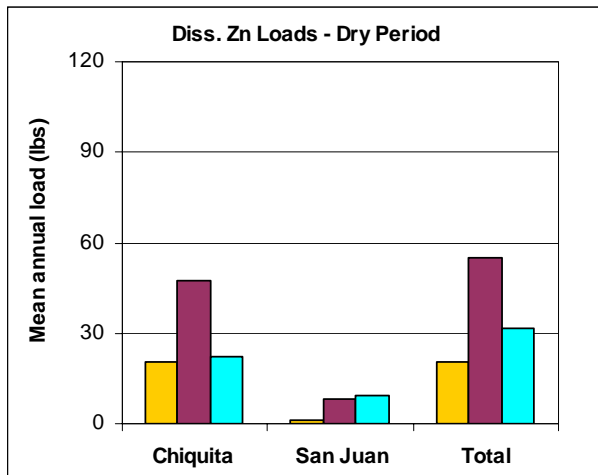
Water Quality Management Plan  
 Rancho Mission Viejo





- Existing
- Post- Developed
- Post- Developed w/ BMPs

**Figure 5-11**  
**Predicted Average Annual Dissolved Lead Loads and Concentrations for Cañada Chiquita**



- Existing
- Post- Developed
- Post- Developed w/ BMPs

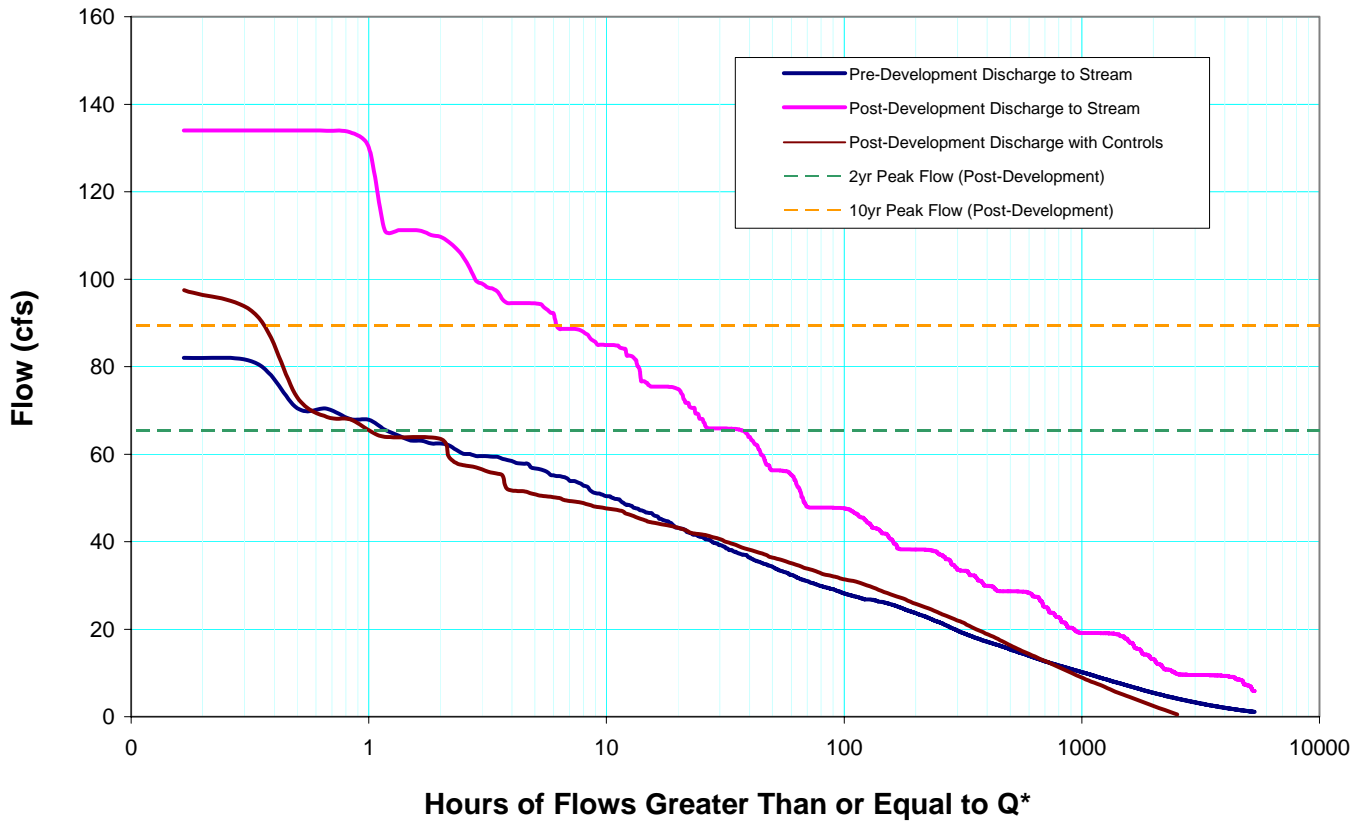
**Figure 5-12**  
**Predicted Average Annual Dissolved Zinc Loads and Concentrations for Cañada Chiquita**

March 2004

Water Quality Management Plan  
 Rancho Mission Viejo



### Cumulative Frequency Distribution



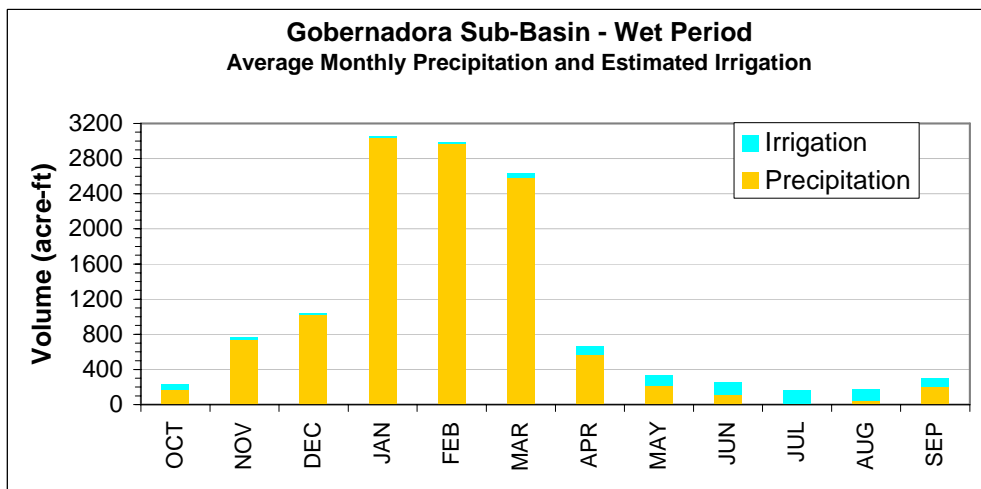
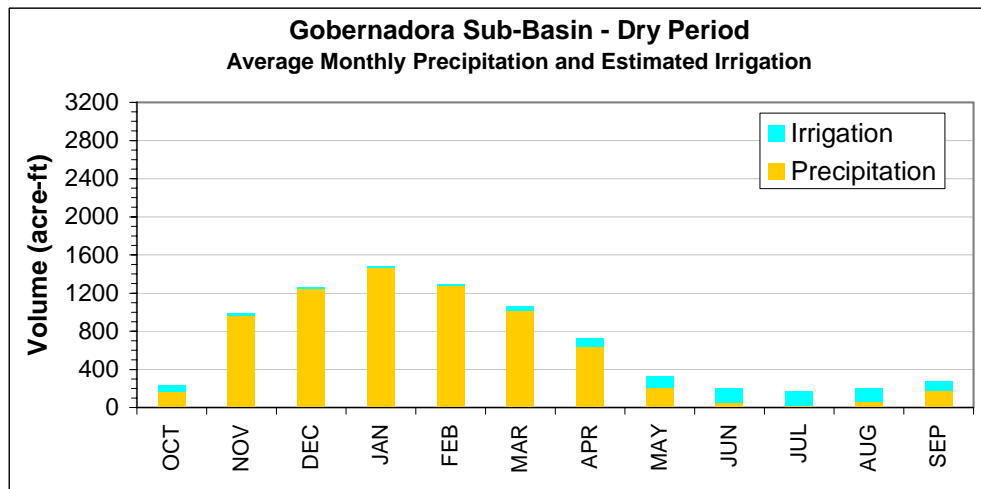
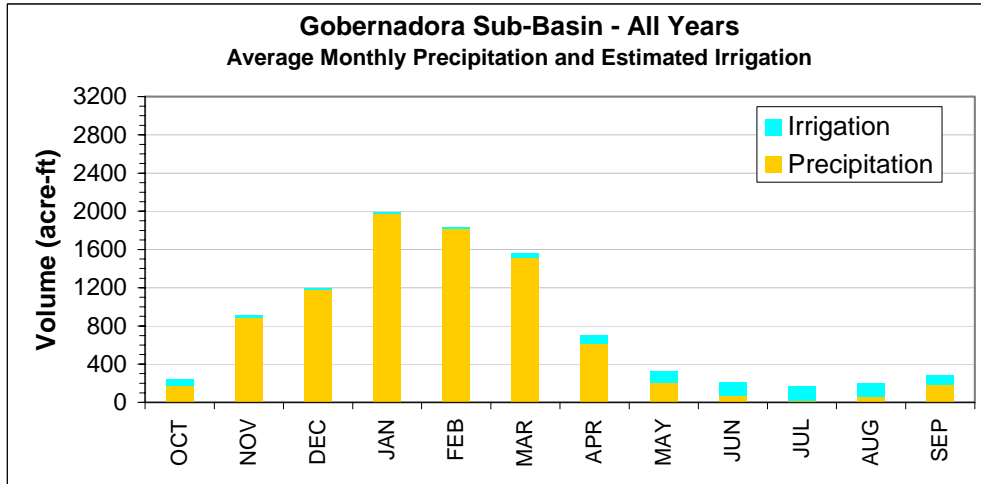
\* for 53 years of rainfall record; Water Years 1949-2001

**Figure 5-13**  
**Flow Duration Curves for Cañada Gobernadora- Catchment 3**

March 2004

Water Quality Management Plan  
 Rancho Mission Viejo

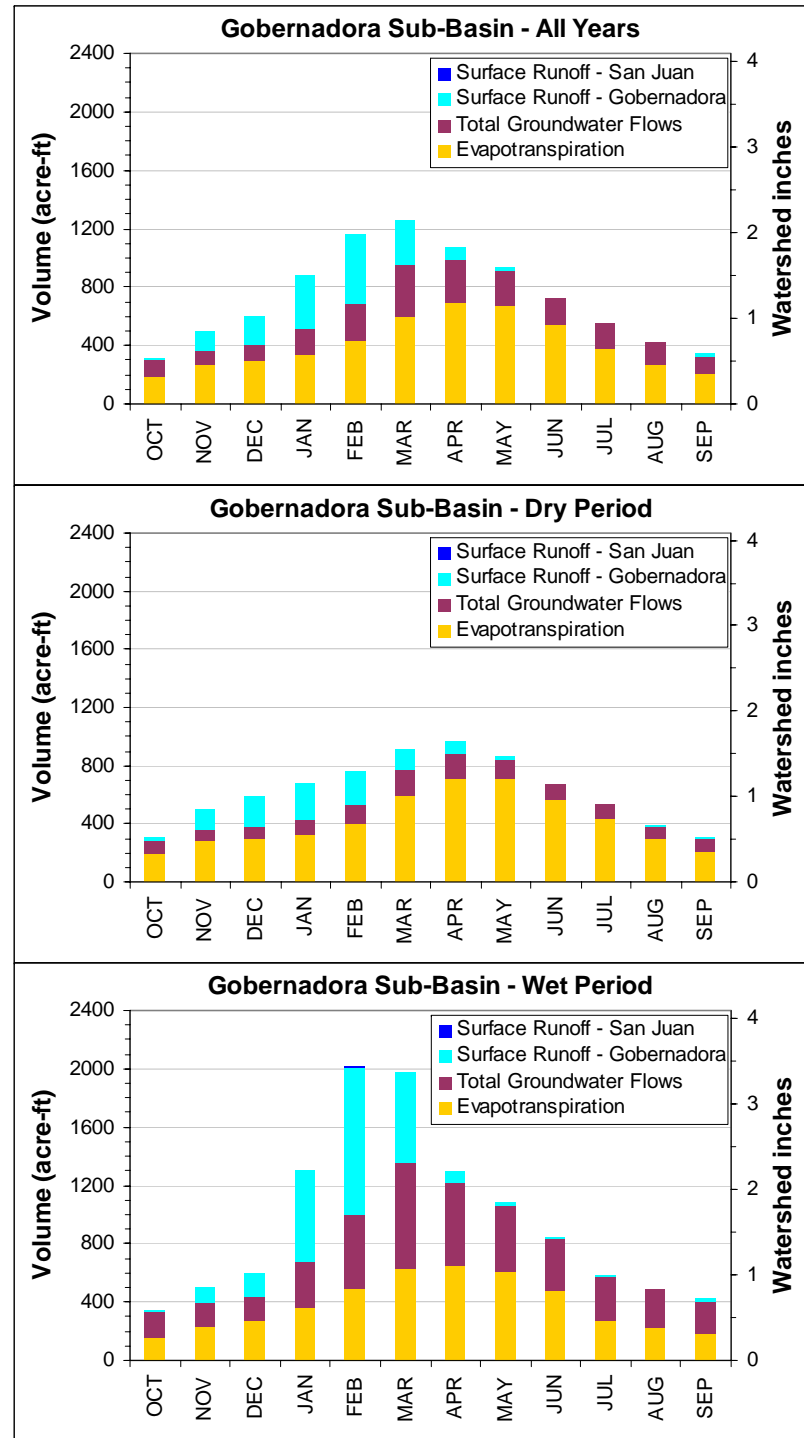




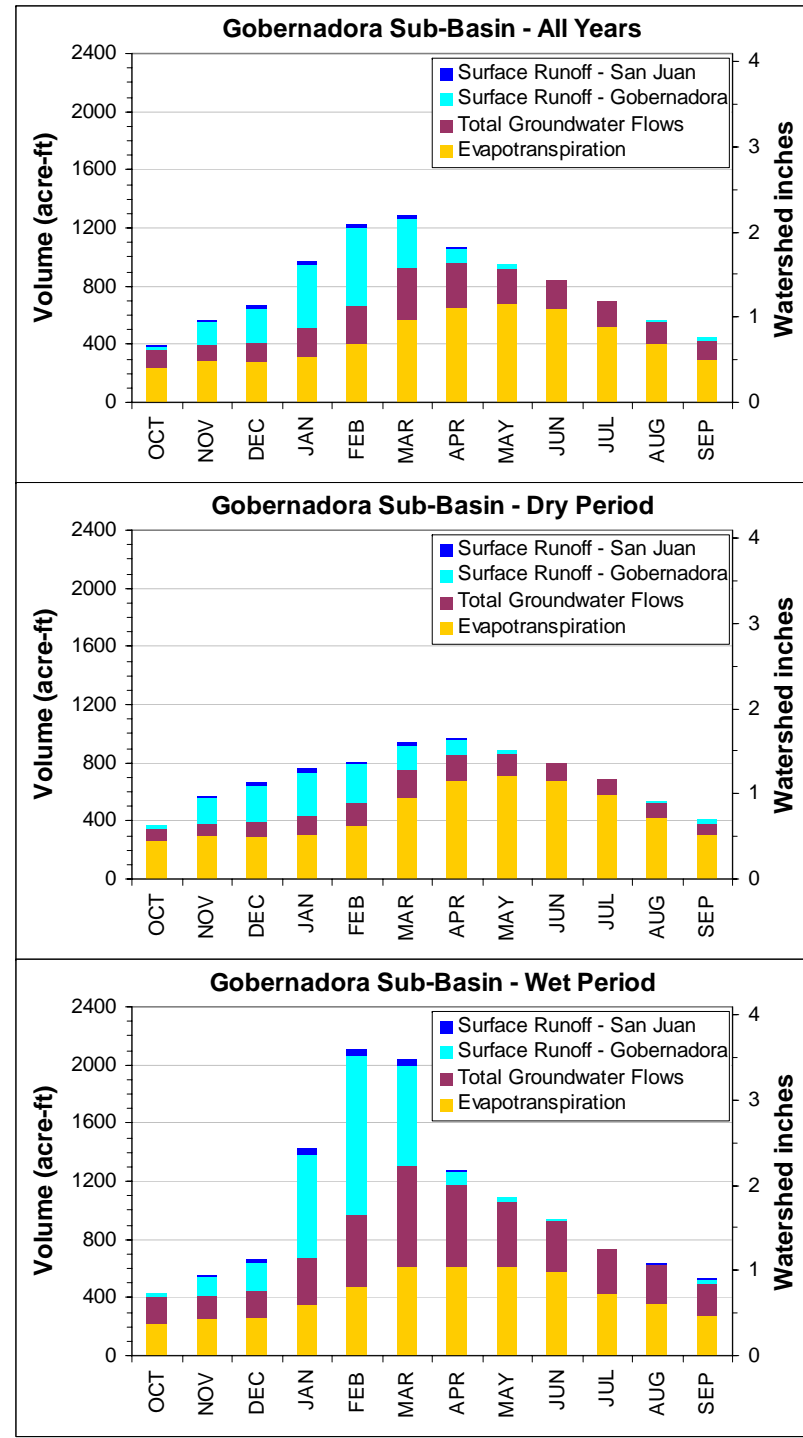
**Figure 5-14**  
**Comparison of Average Monthly Precipitation for Cañada Gobernadora**



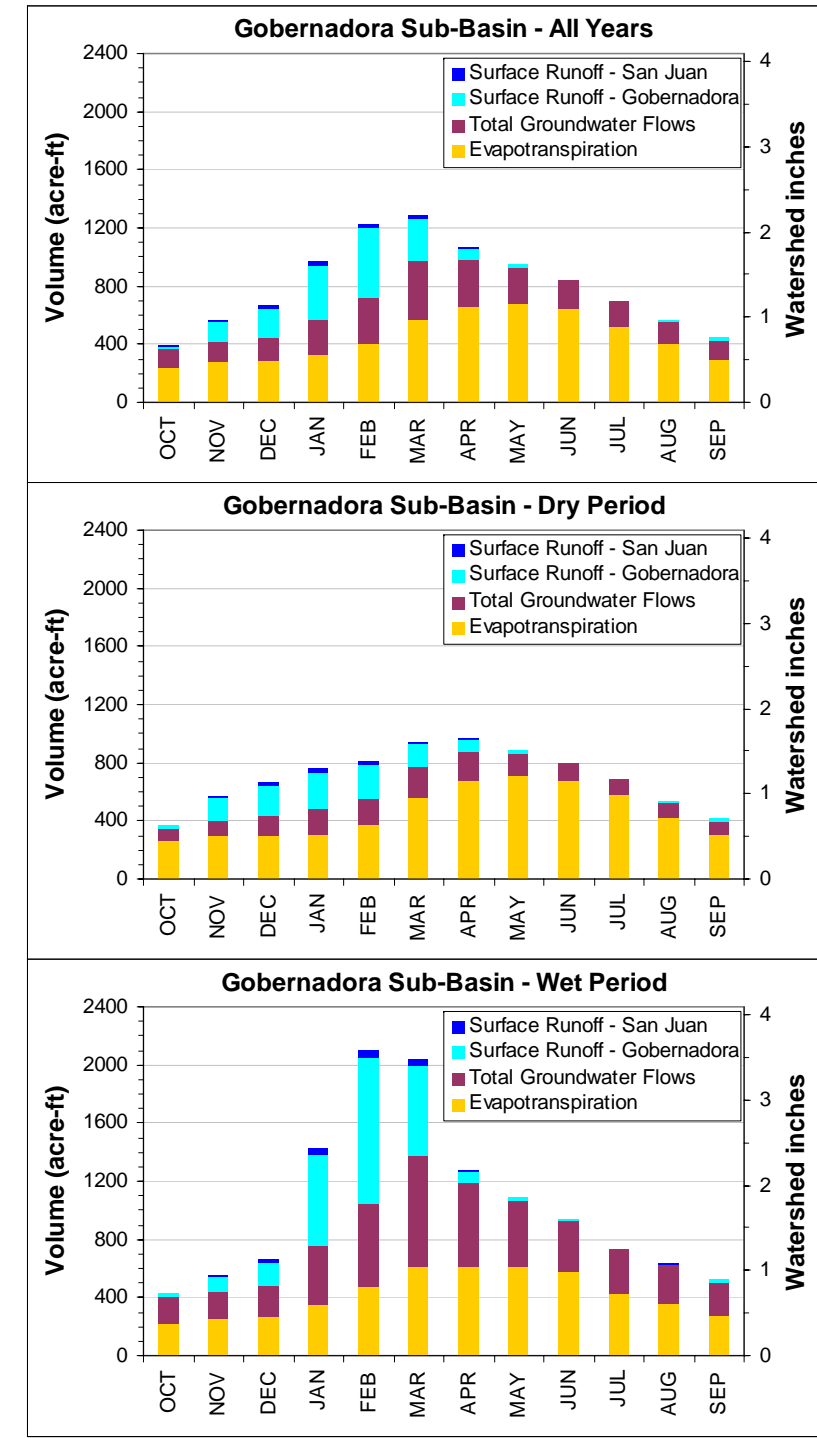
## Pre-Development



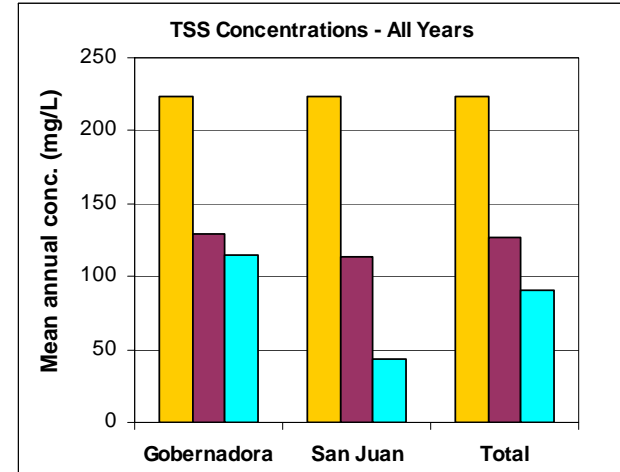
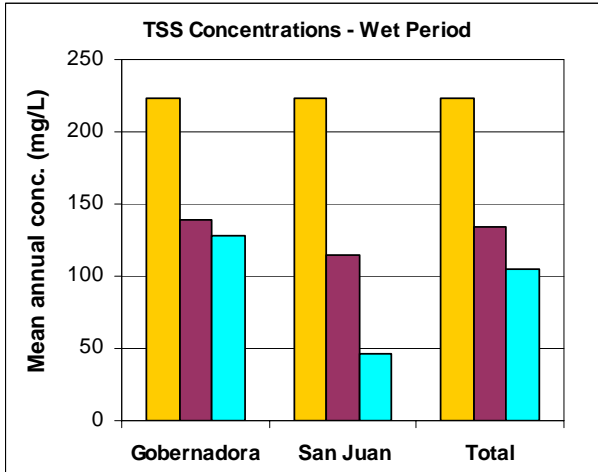
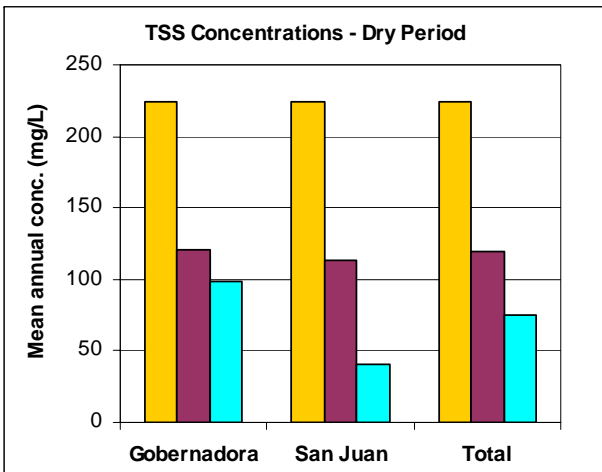
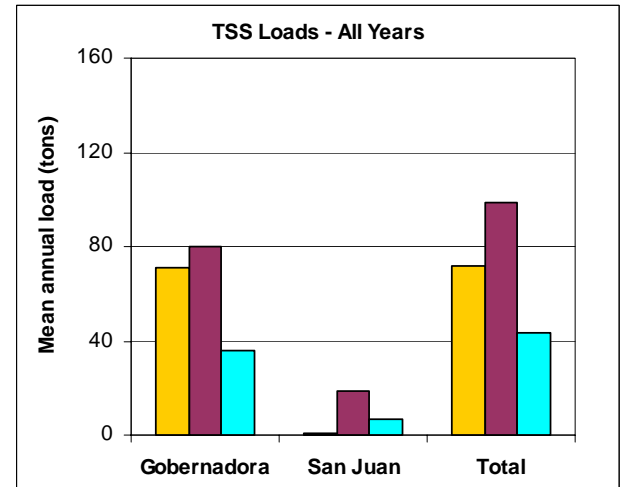
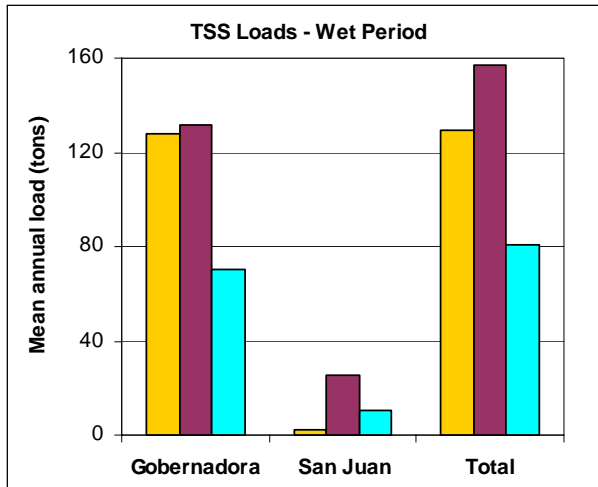
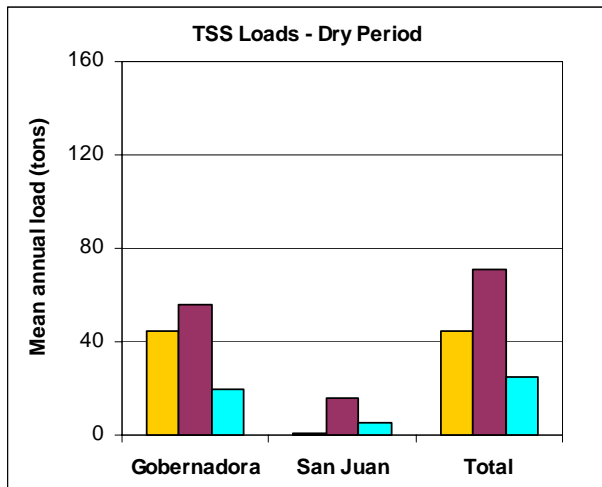
## Post-Development, No BMPs



## Post-Development, With BMPs

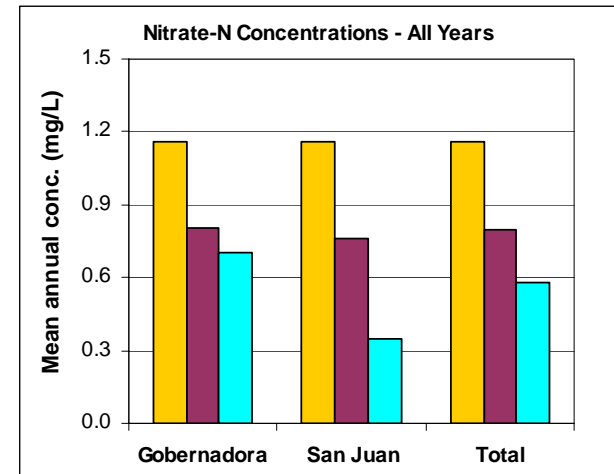
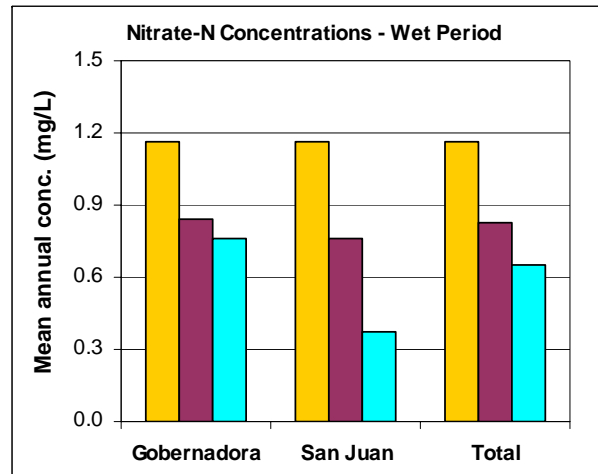
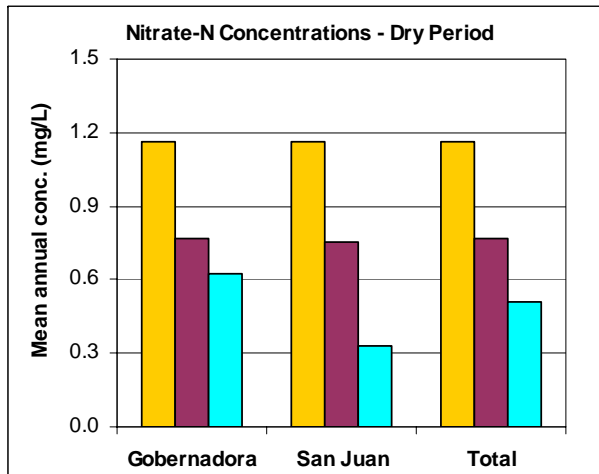
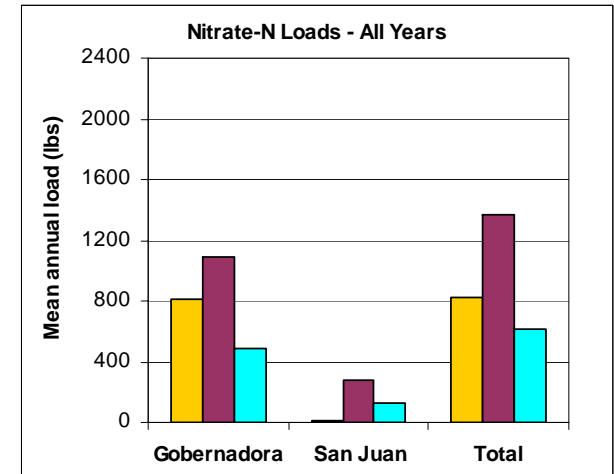
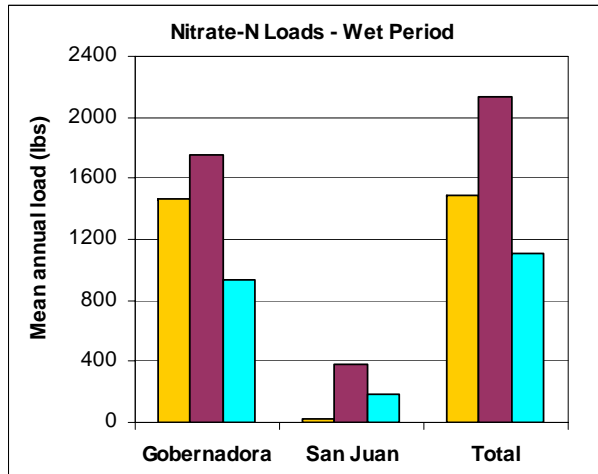
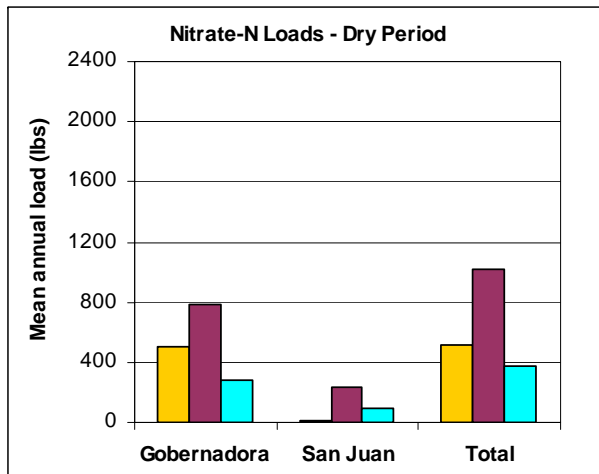


**Figure 5-15**  
Water Balance Results for the Cañada Gobernadora Sub-basin



- Existing
- Post- Developed
- Post- Developed w/ BMPs

**Figure 5-16**  
**Predicted Average Annual TSS Loads and Concentrations for Cañada Gobernadora**



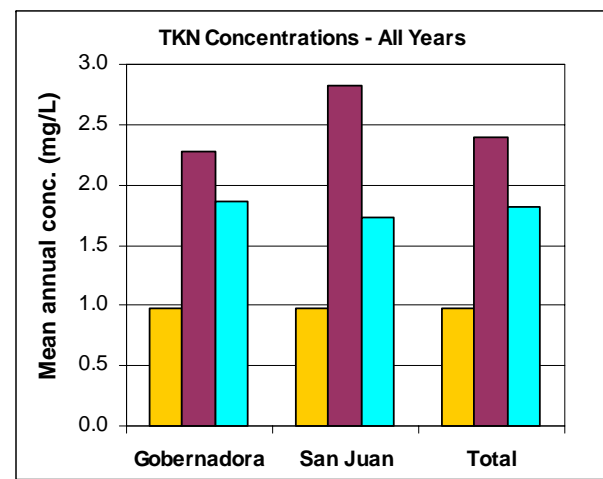
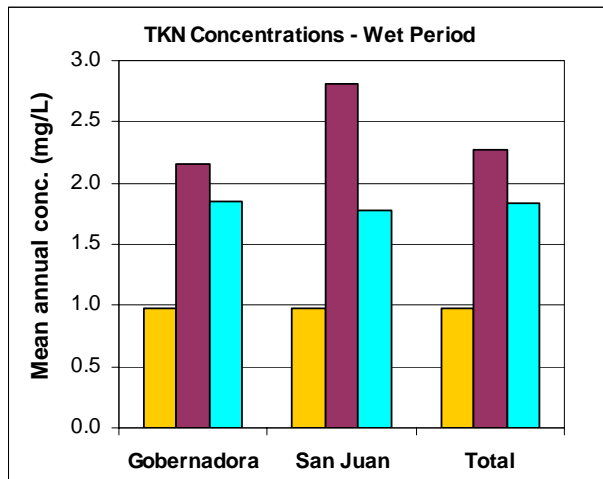
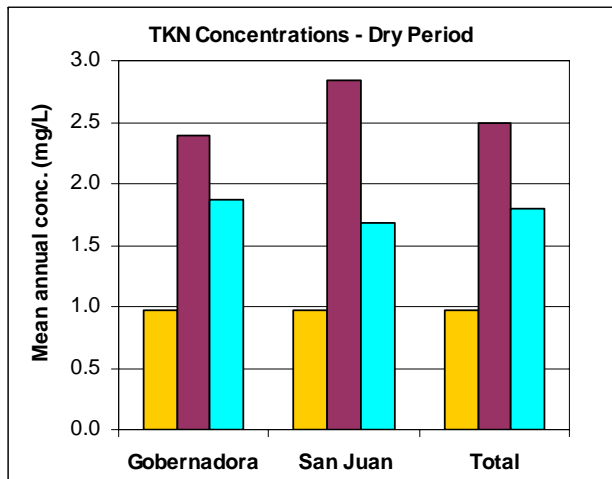
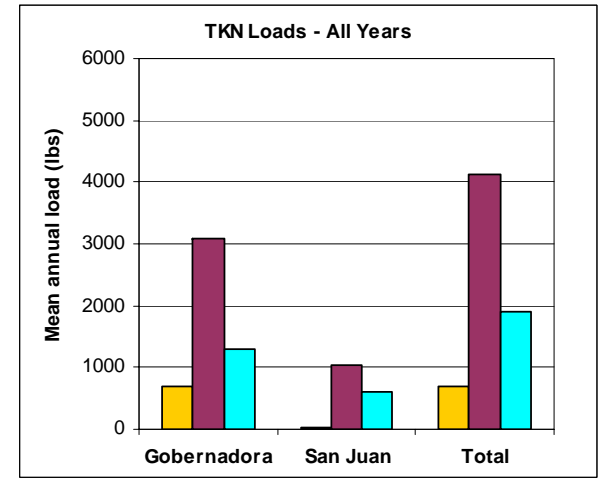
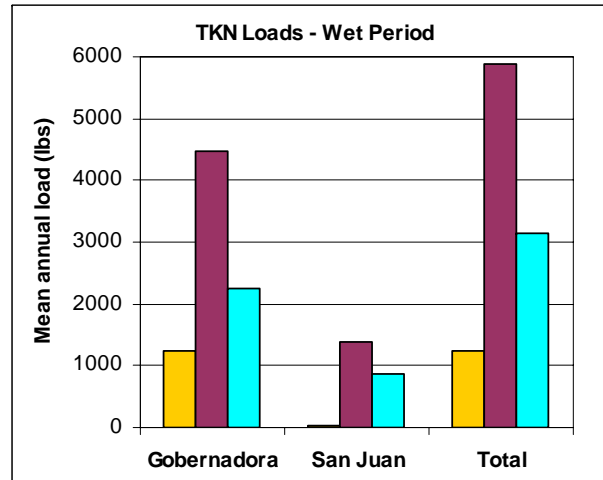
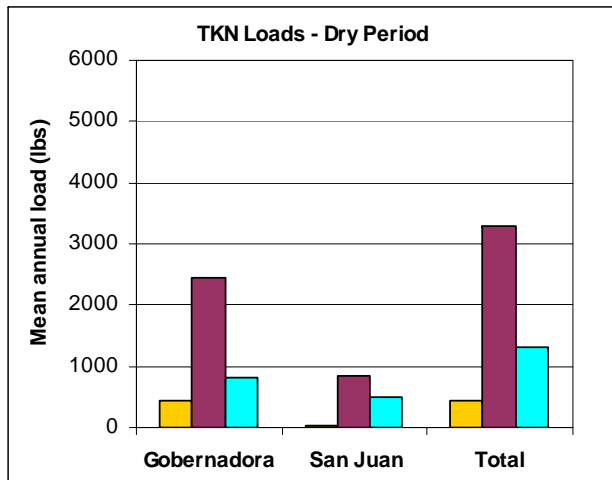
- Existing
- Post- Developed
- Post- Developed w/ BMPs

**Figure 5-17**  
**Predicted Average Annual Nitrate-N Loads and Concentrations for Cañada Gobernadora**

March 2004

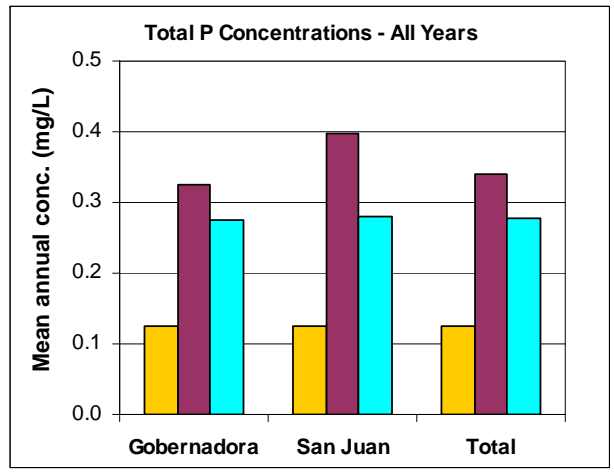
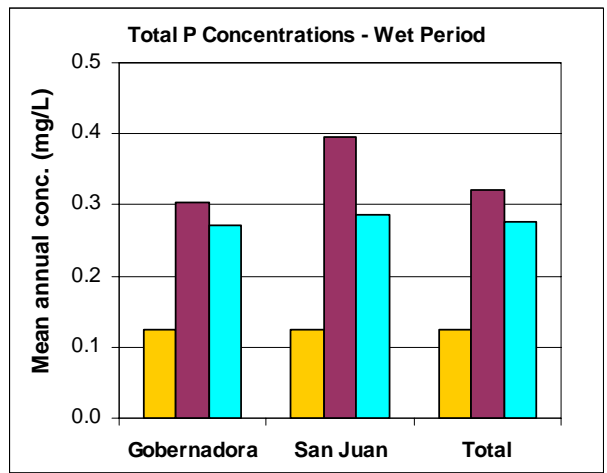
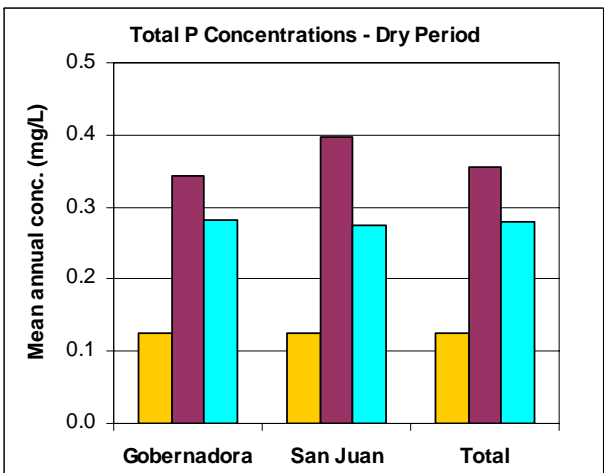
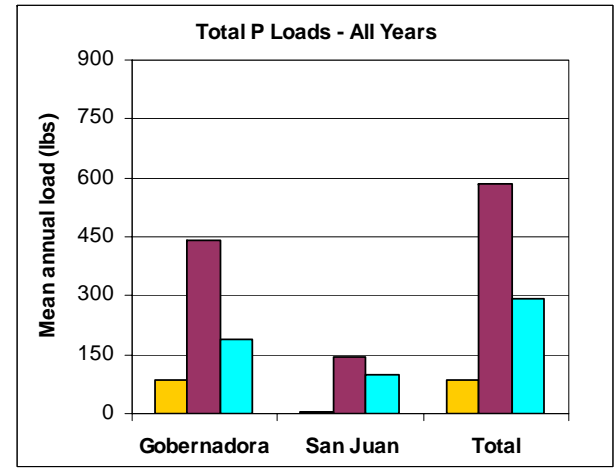
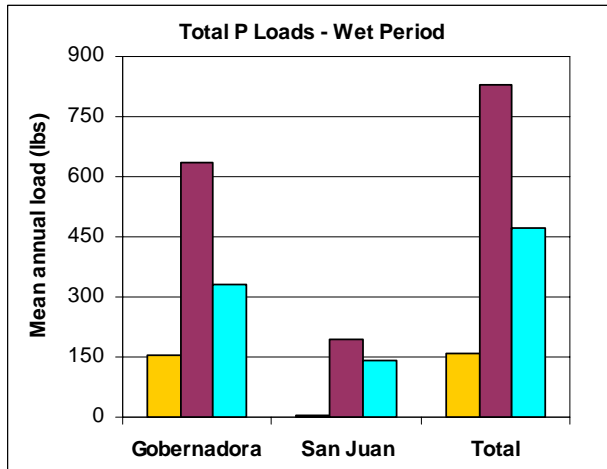
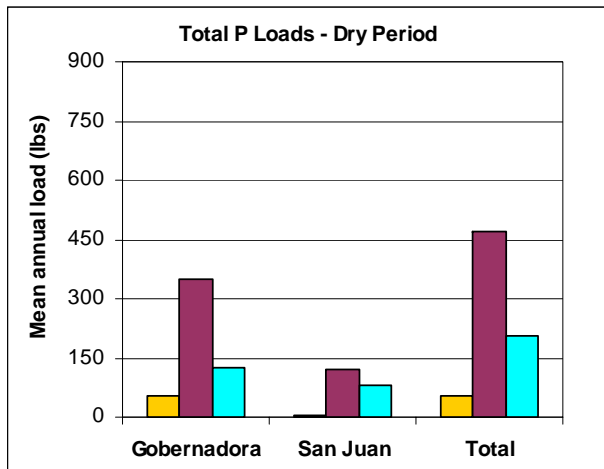
Water Quality Management Plan  
 Rancho Mission Viejo





- Existing
- Post- Developed
- Post- Developed w/ BMPs

**Figure 5-18**  
**Predicted Average Annual TKN Loads and Concentrations for Cañada Gobernadora**



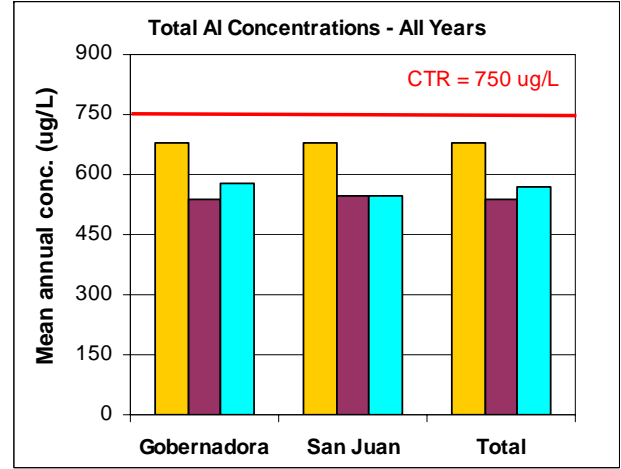
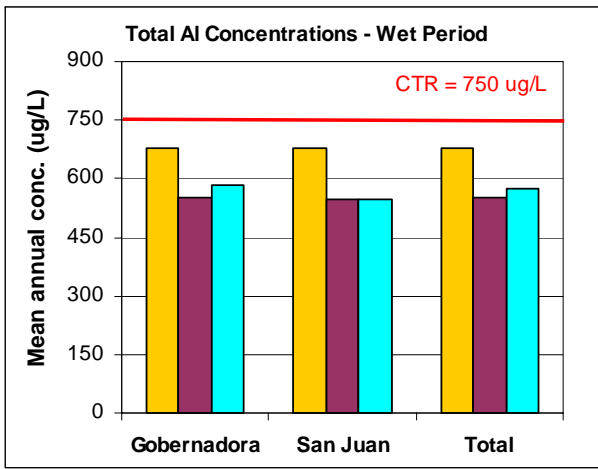
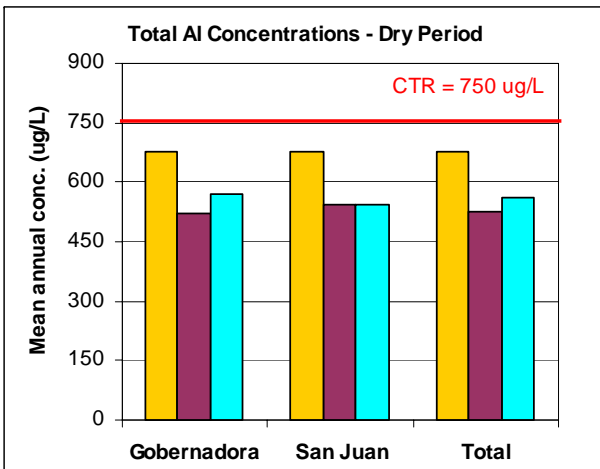
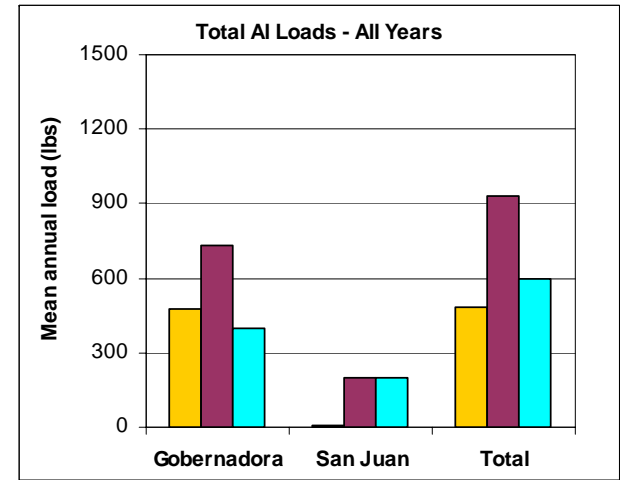
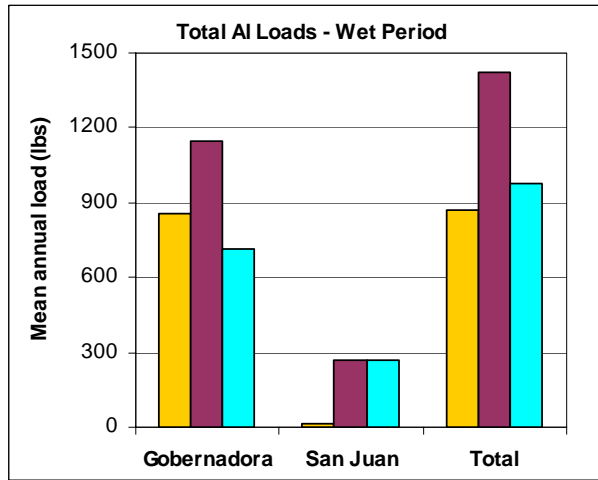
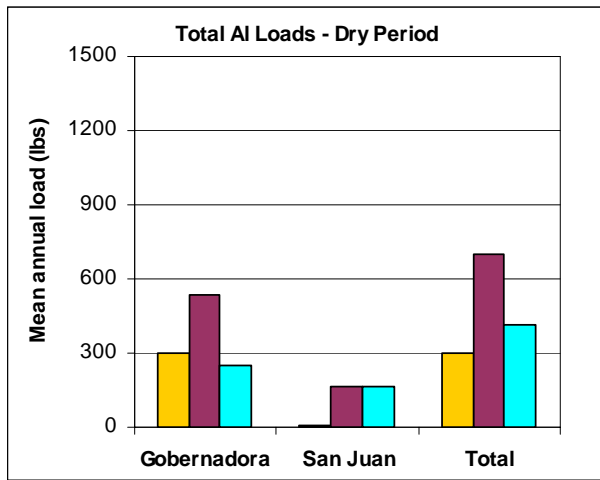
- Existing
- Post- Developed
- Post- Developed w/ BMPs

**Figure 5-19**  
**Predicted Average Annual Total Phosphorous Loads and Concentrations for Cañada Gobernadora**

March 2004

Water Quality Management Plan  
 Rancho Mission Viejo





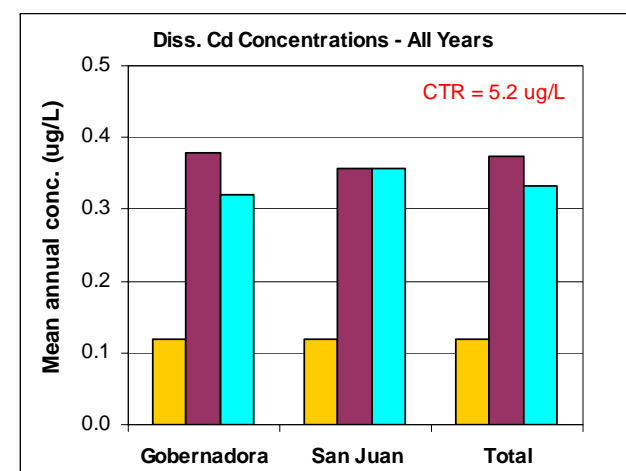
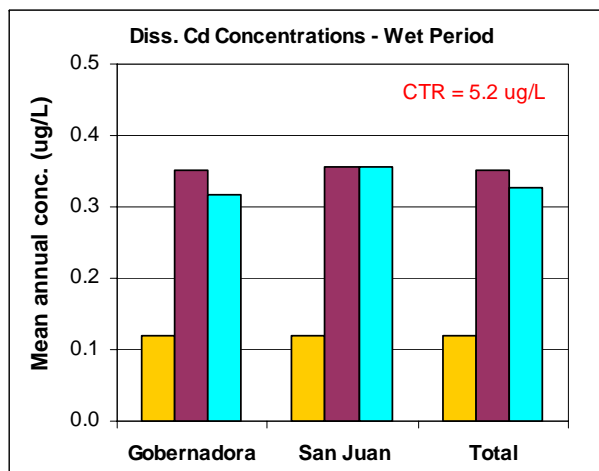
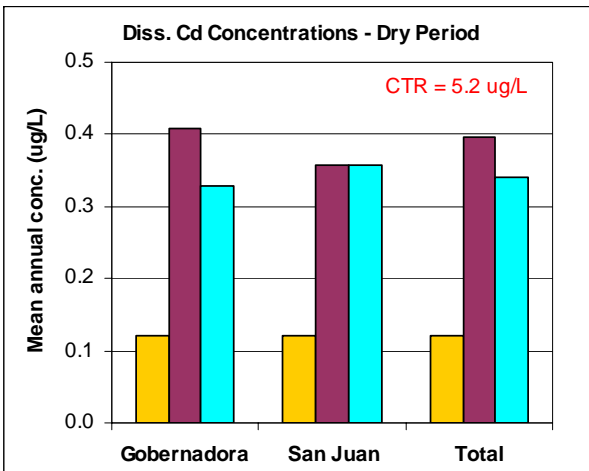
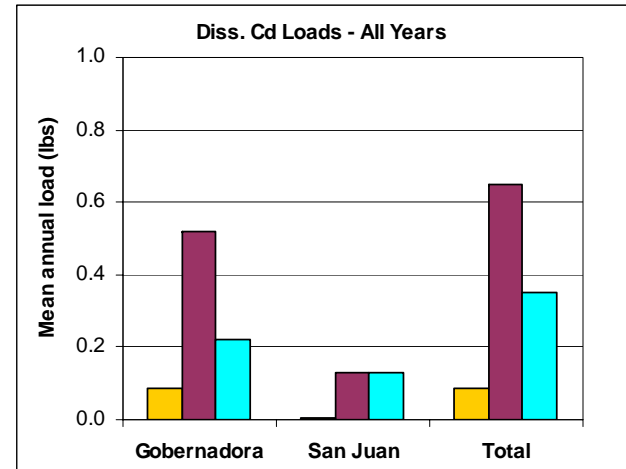
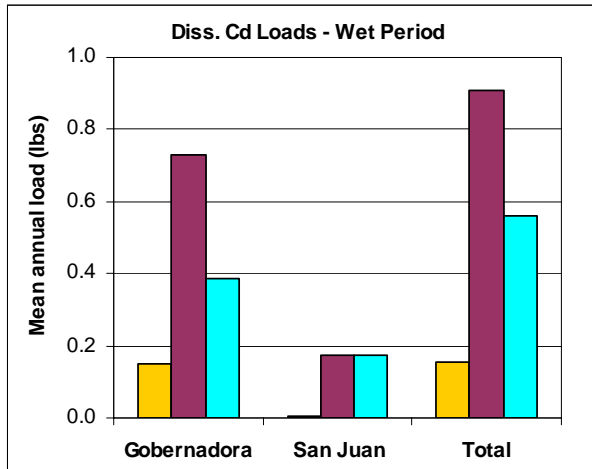
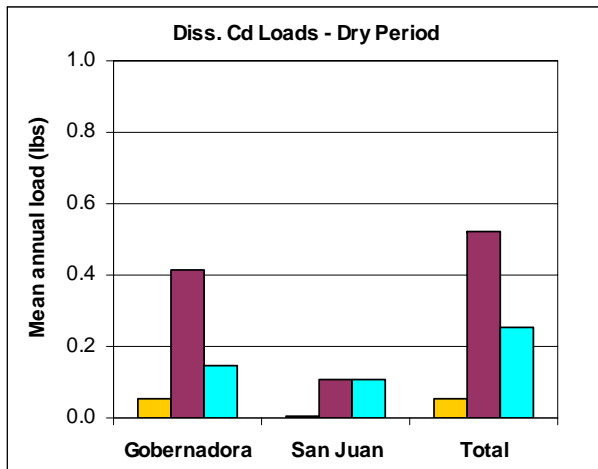
- Existing
- Post- Developed
- Post- Developed w/ BMPs

**Figure 5-20**  
**Predicted Average Annual Total Aluminum Loads and Concentrations for Cañada Gobernadora**

March 2004

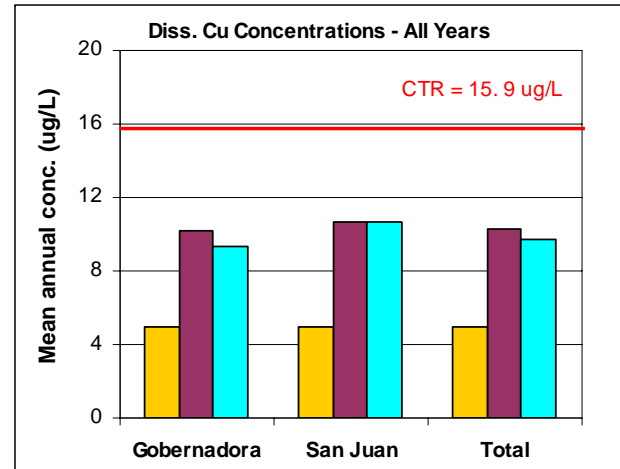
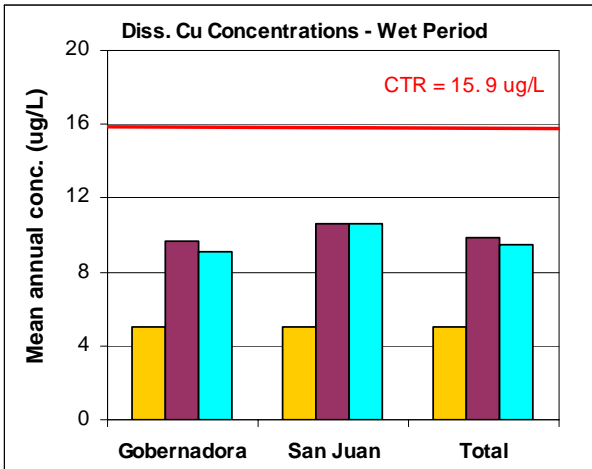
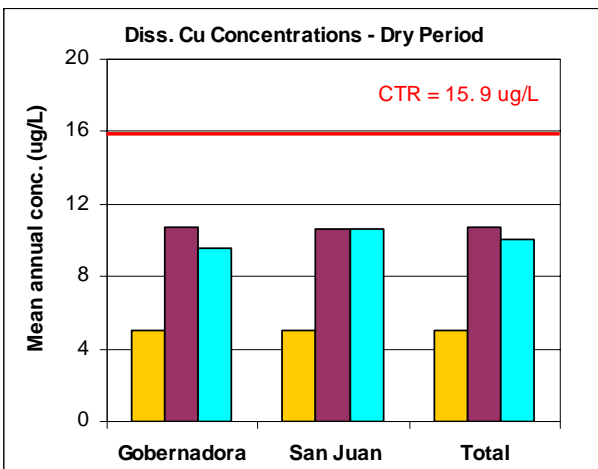
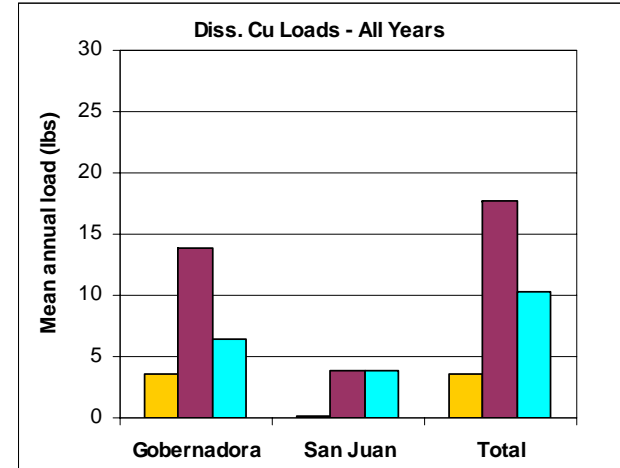
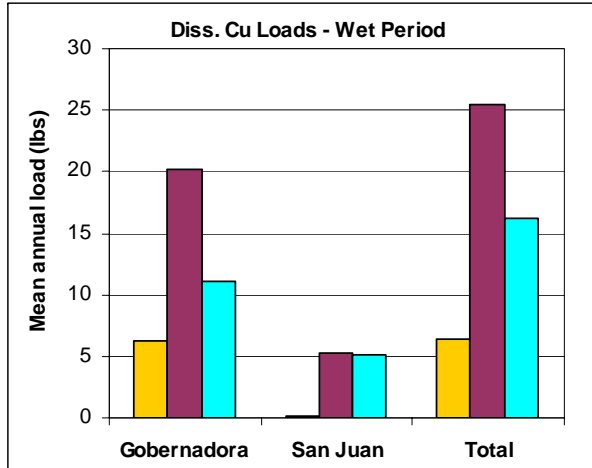
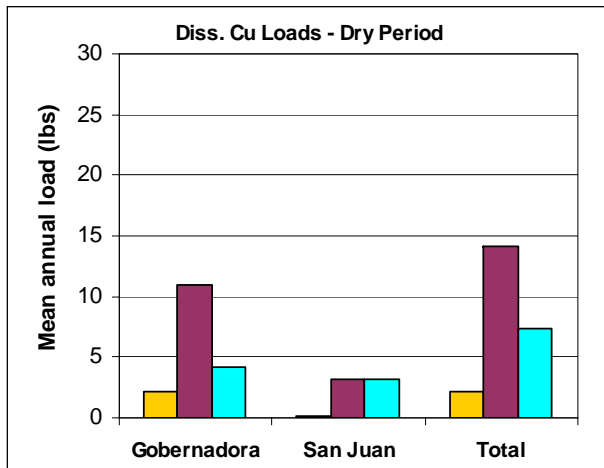
Water Quality Management Plan  
 Rancho Mission Viejo





- Existing
- Post- Developed
- Post- Developed w/ BMPs

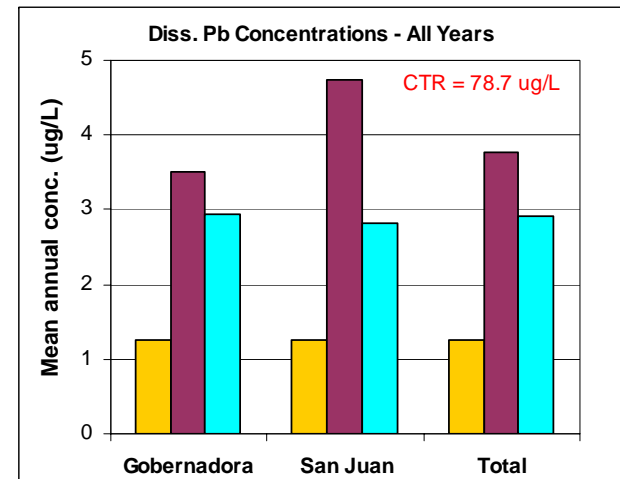
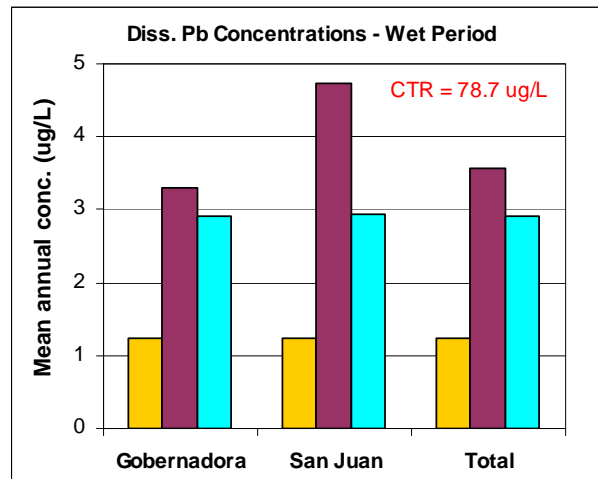
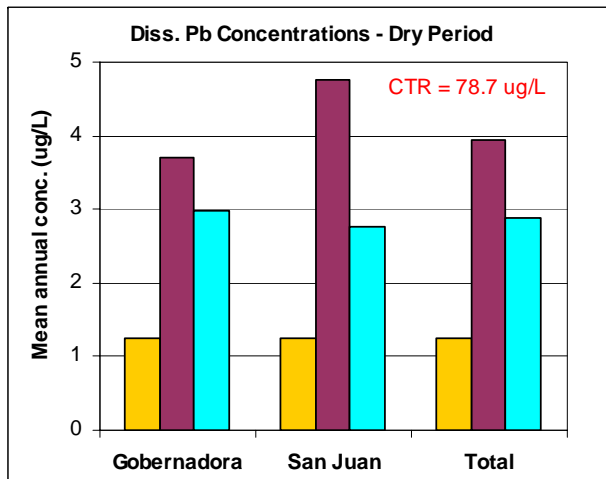
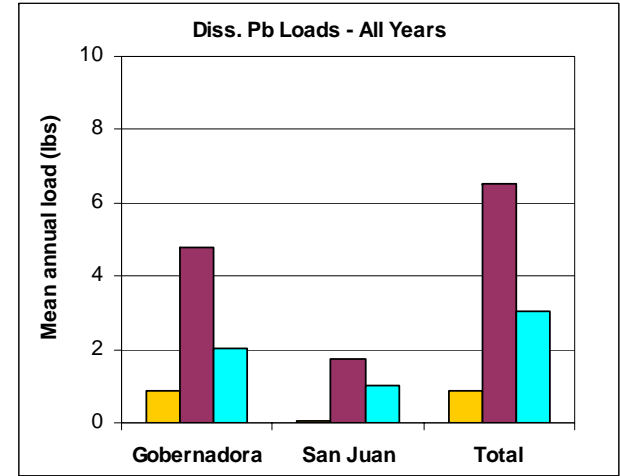
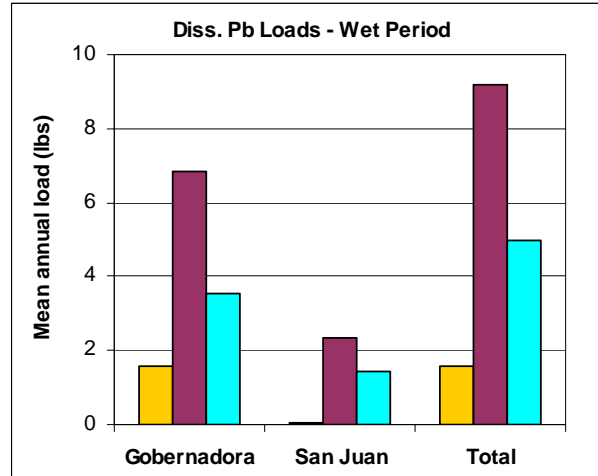
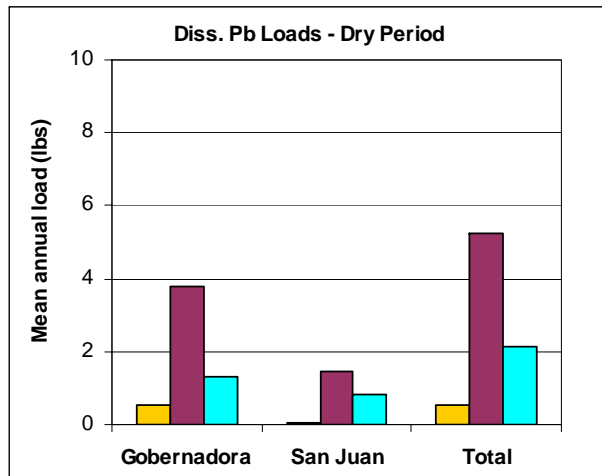
**Figure 5-21**  
**Predicted Average Annual Total Dissolved Cadmium Loads and Concentrations for Cañada Gobernadora**



- Existing
- Post- Developed
- Post- Developed w/ BMPs

**Figure 5-22**  
**Predicted Average Annual Total Dissolved Copper Loads and Concentrations for Cañada Gobernadora**





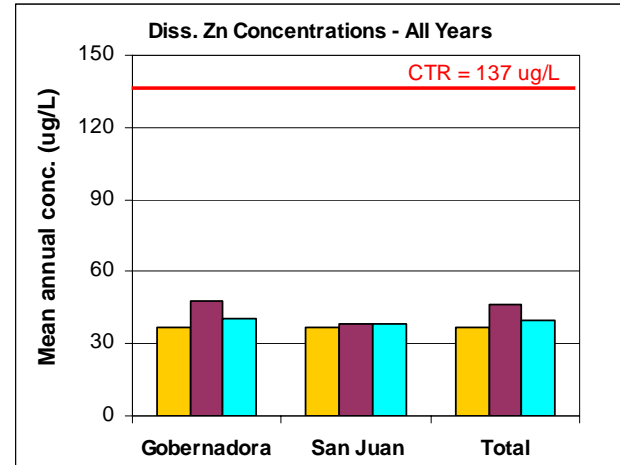
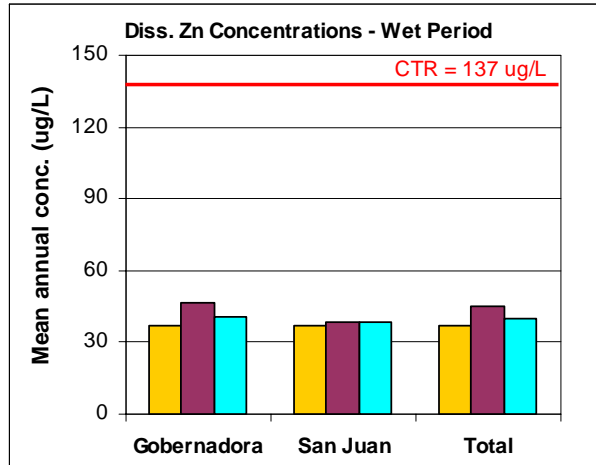
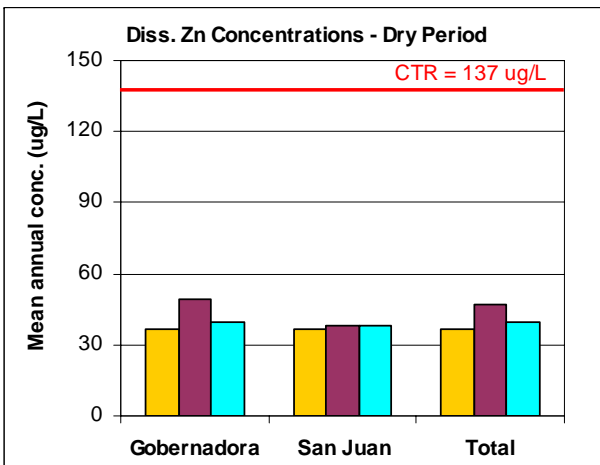
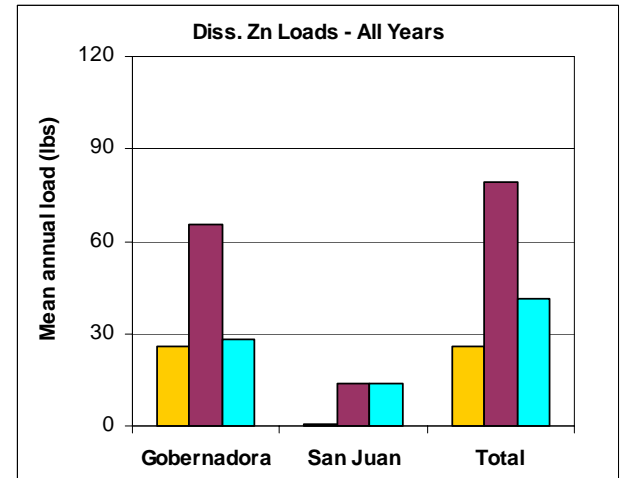
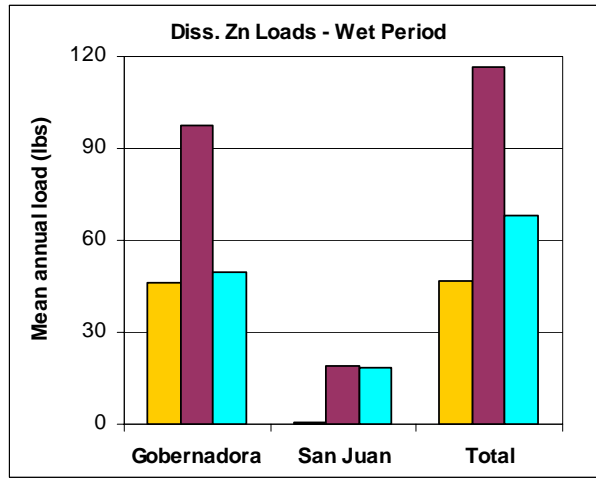
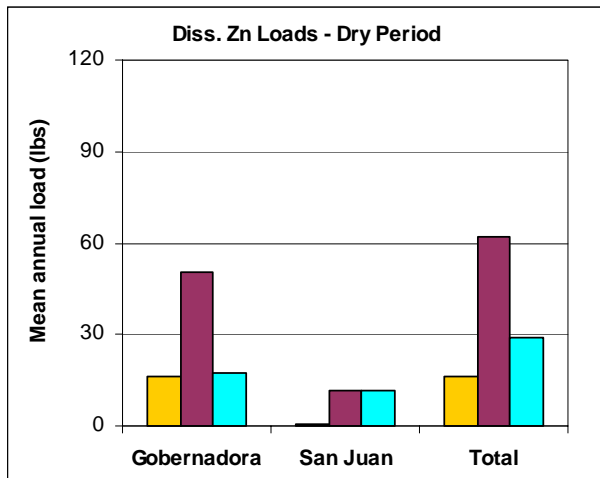
- Existing
- Post- Developed
- Post- Developed w/ BMPs

**Figure 5-23**  
**Predicted Average Annual Total Dissolved Lead Loads and Concentrations for Cañada Gobernadora**

March 2004

Water Quality Management Plan  
 Rancho Mission Viejo





- Existing
- Post- Developed
- Post- Developed w/ BMPs

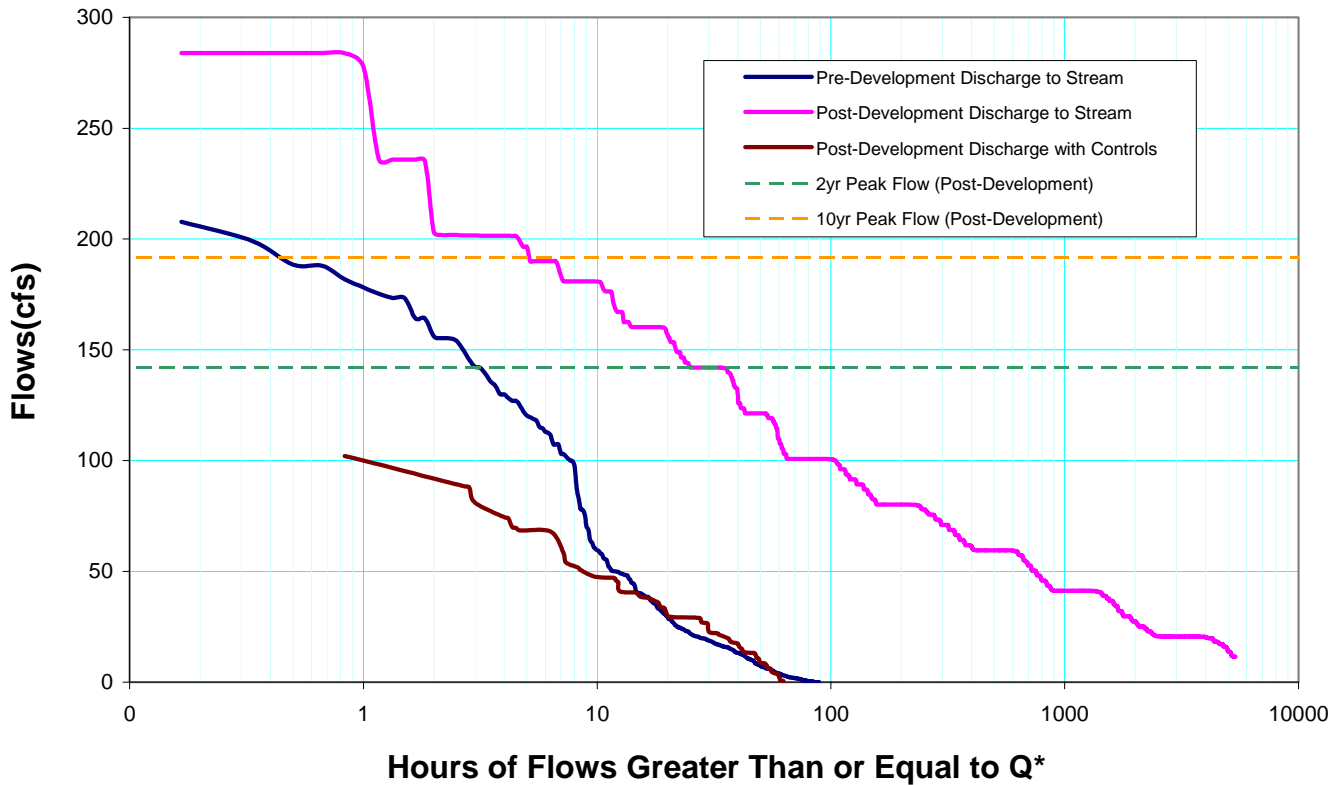
**Figure 5-24**  
**Predicted Average Annual Total Dissolved Zinc Loads and Concentrations for Cañada Gobernadora**

March 2004

Water Quality Management Plan  
 Rancho Mission Viejo



### Cumulative Frequency Distribution



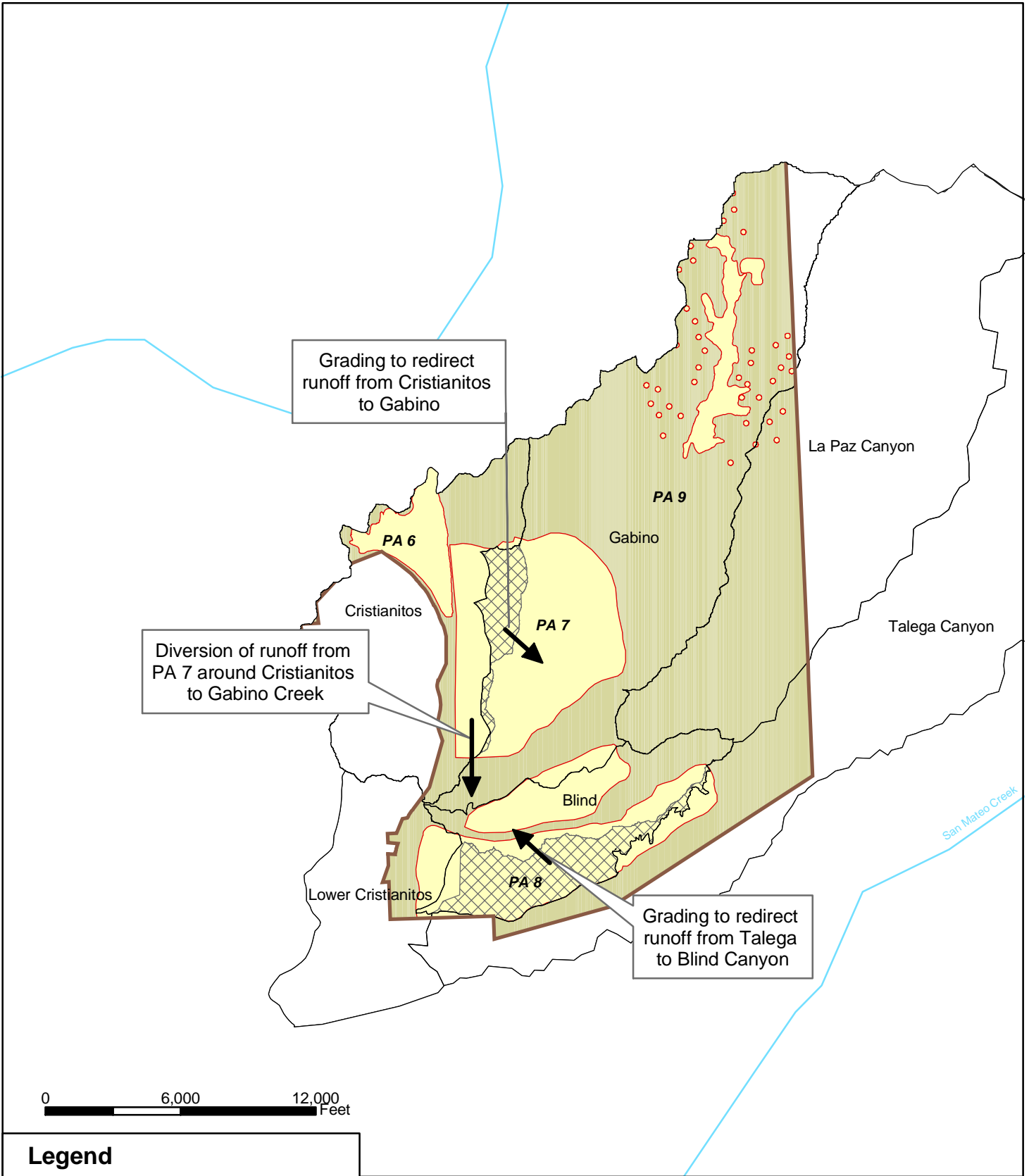
\* for 53 years of rainfall record; Water Years 1949-2001

**Figure 5-25**  
**Flow Duration Curves for Central San Juan and Trampas- Catchments 25a, 25b, and PA5-4**

March 2004

Water Quality Management Plan  
 Rancho Mission Viejo





**Legend**

- Planning Area
- Open Space
- Sub-basin Boundary
- Rancho Mission Viejo Boundary
- Areas graded to redirect runoff to adjacent, less sensitive sub-basin



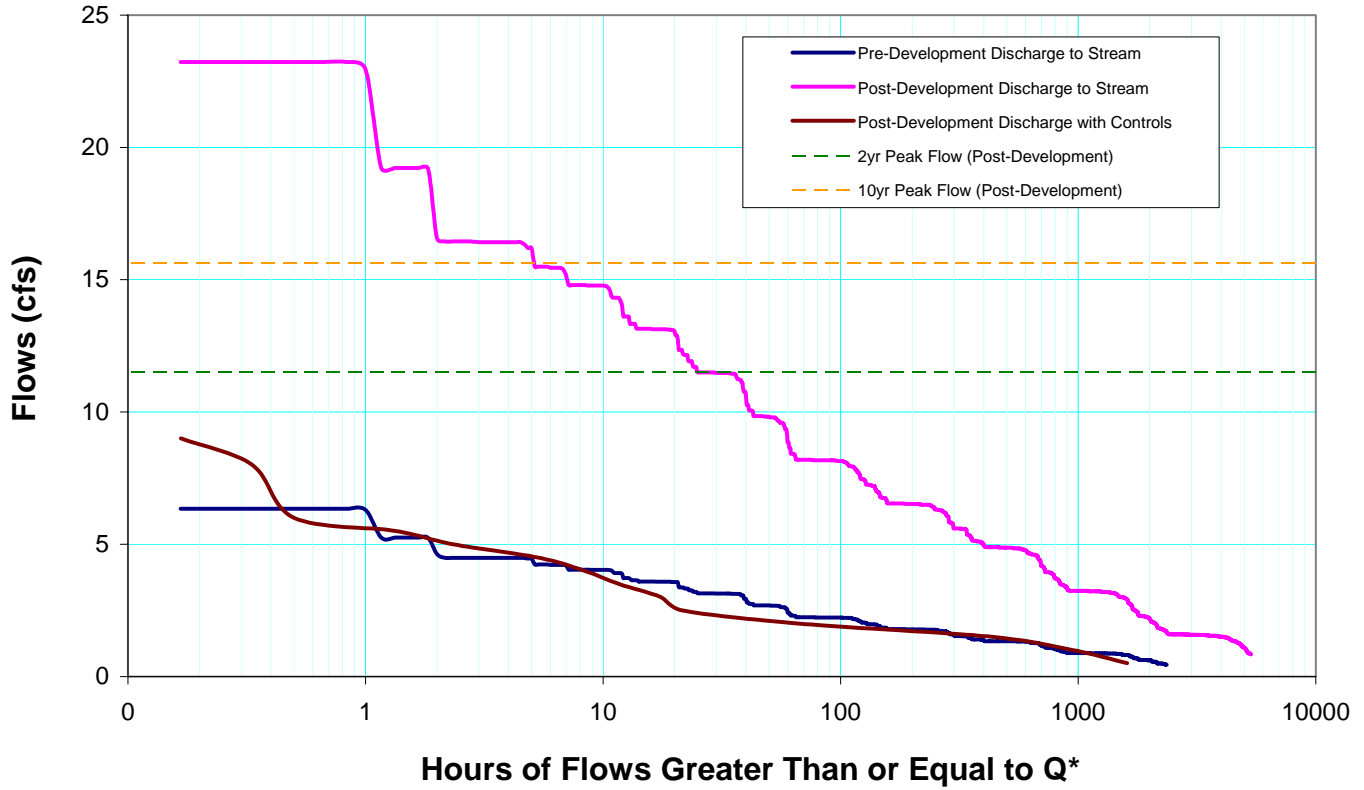
**Figure 5-26  
Runoff Routing in PA 7 and PA 8  
for the B-4 Alternative**

March 2004

Water Quality Management Plan  
Rancho Mission Viejo



## Cumulative Frequency Distribution



\* for 53 years of rainfall record; Water Years 1949-2001

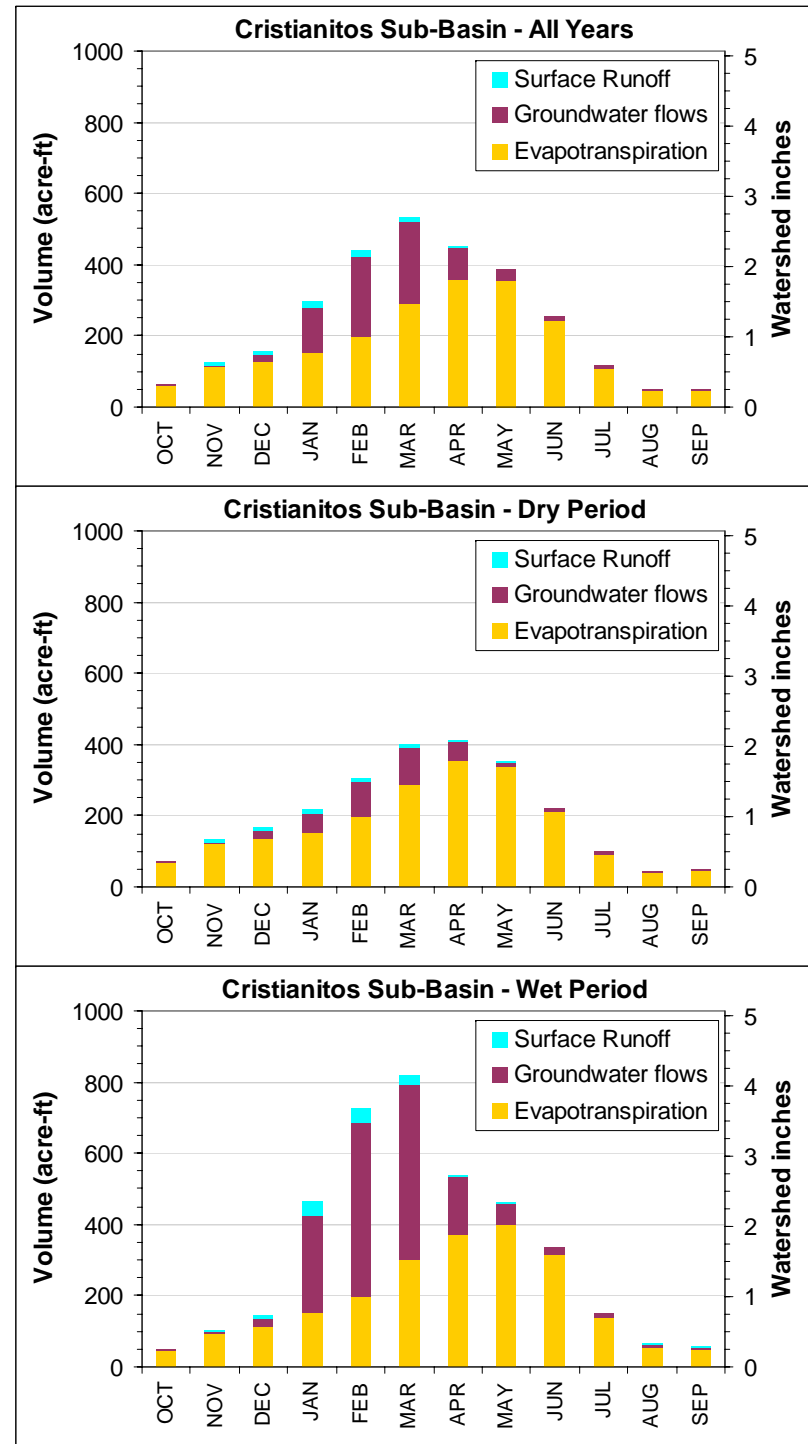
**Figure 5-27**  
**Flow Duration Curves for Cristianitos- Catchment PA7-9**

March 2004

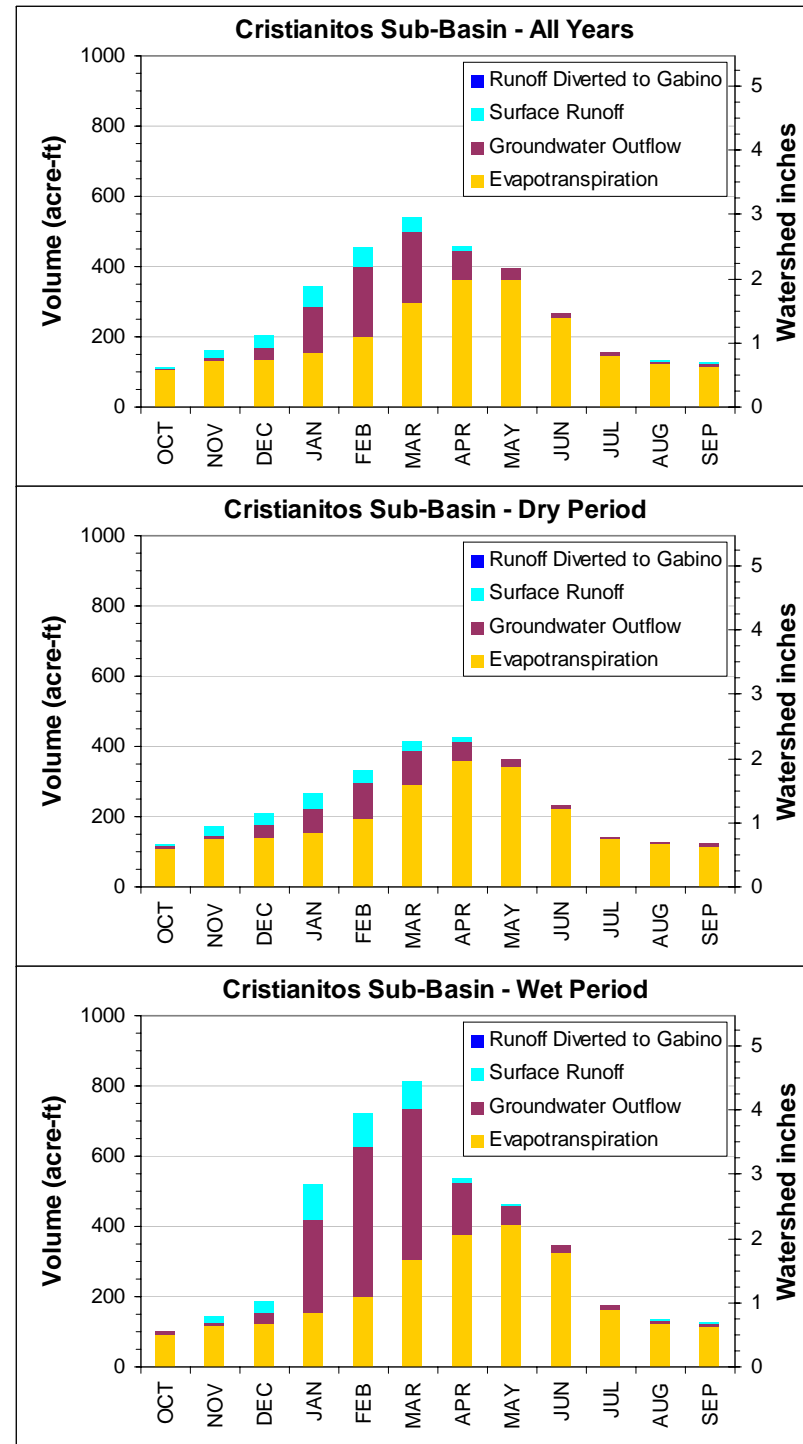
Water Quality Management Plan  
Rancho Mission Viejo



## Pre-Development



## Post-Development, No BMPs



## Post-Development, With BMPs

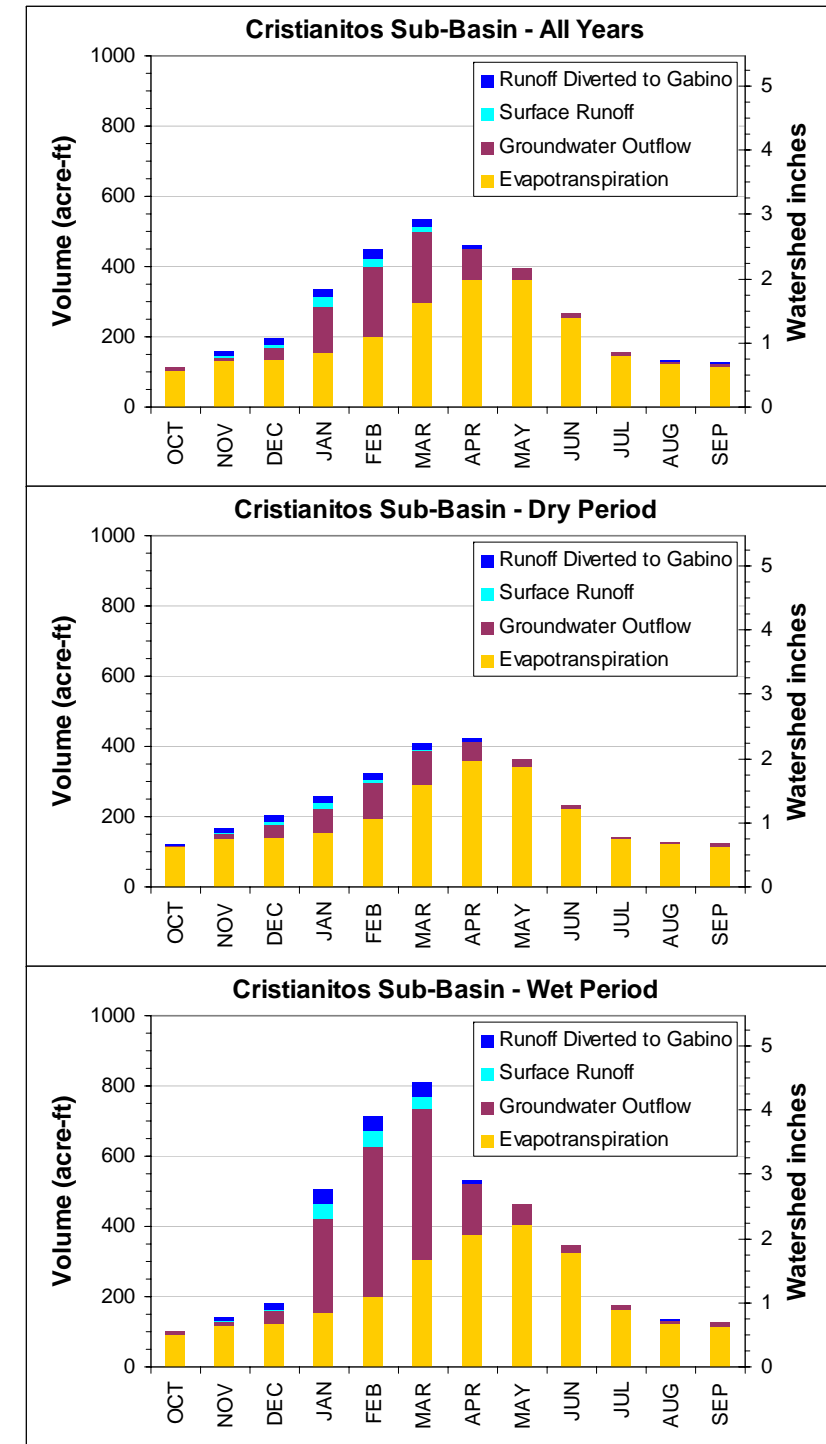
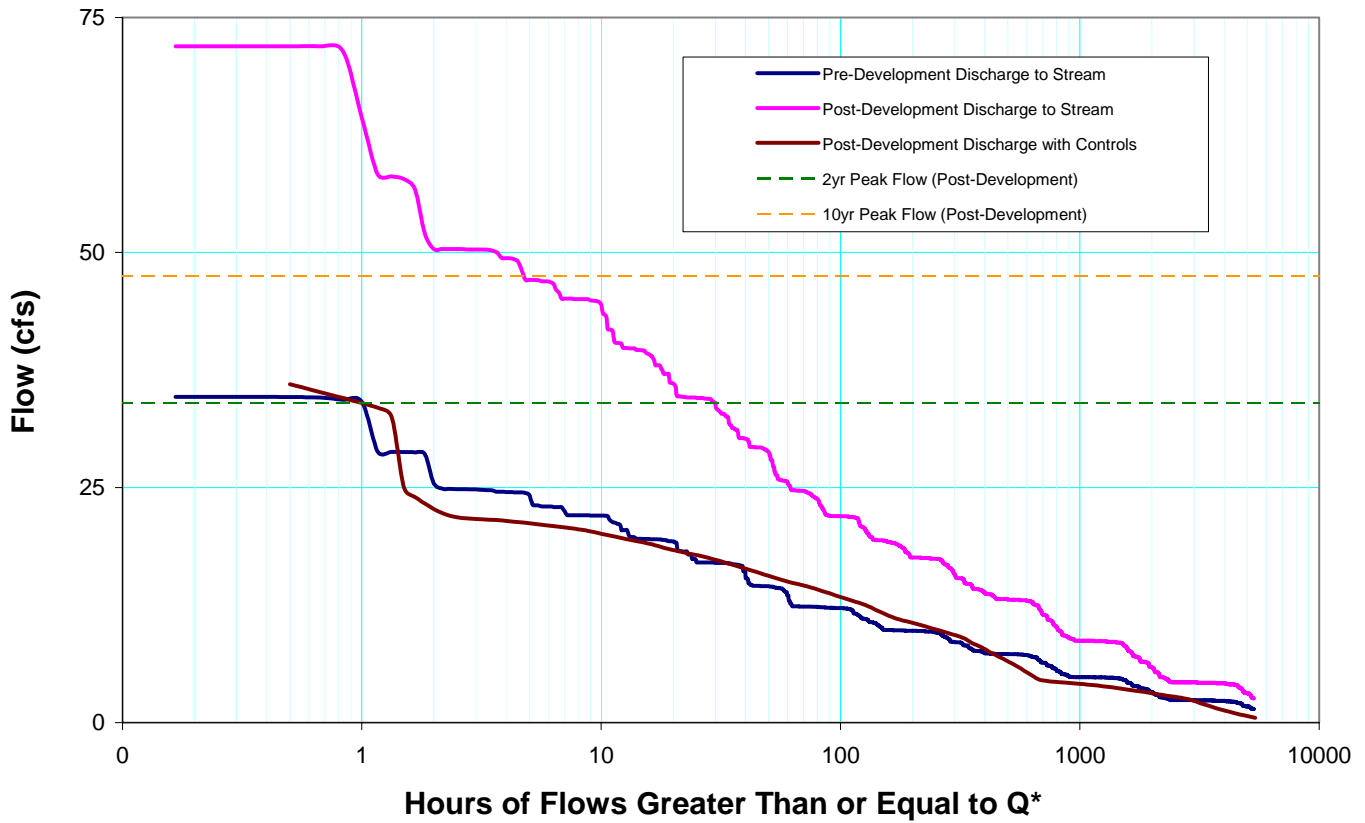


Figure 5-28  
Water Balance Results for the Cristianitos Sub-basin

### Cumulative Frequency Distribution



\* for 53 years of rainfall record; Water Years 1949-2001

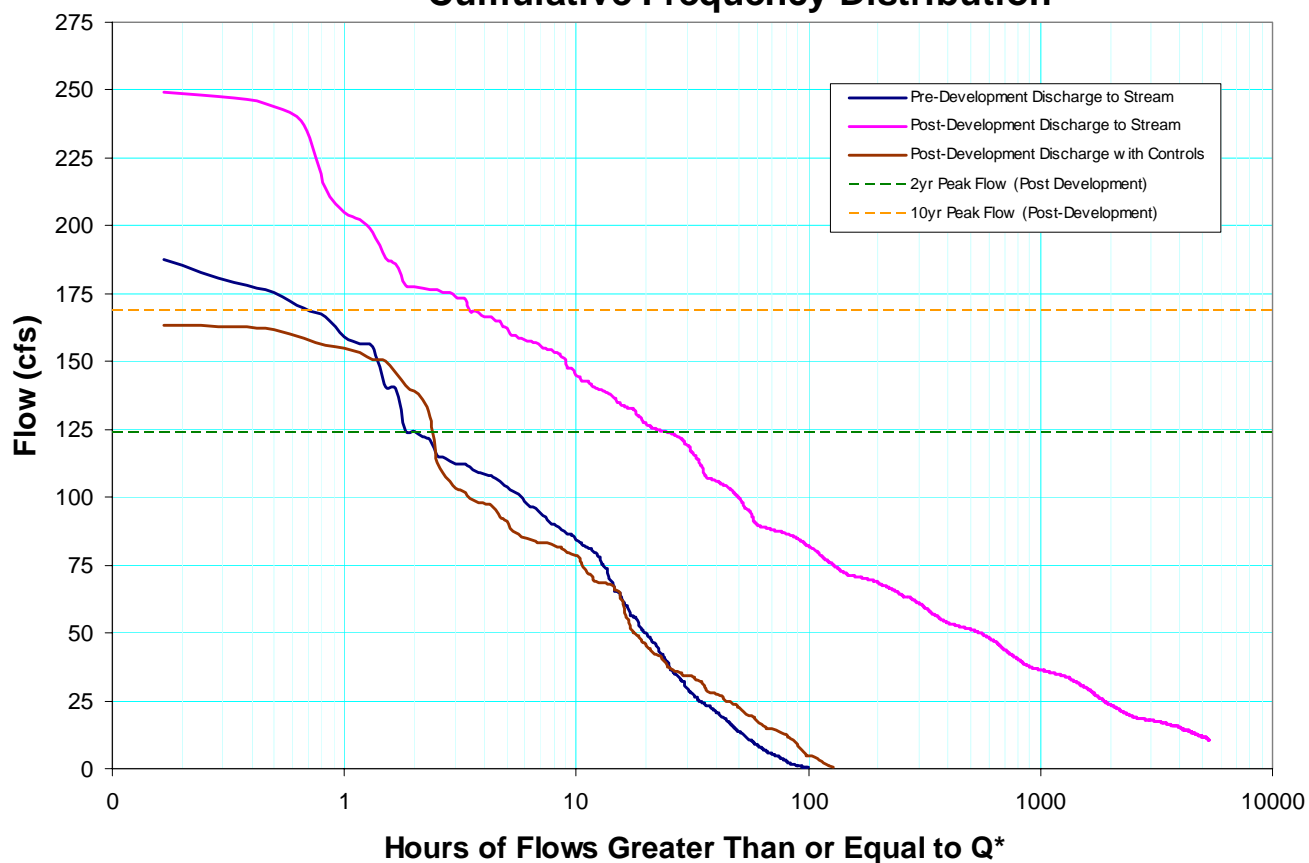
**Figure 5-29**  
**Flow Duration Curves for Talega- Catchment PA8-6**

March 2004

Water Quality Management Plan  
 Rancho Mission Viejo



### Cumulative Frequency Distribution



\* for 53 years of rainfall record; Water Years 1949-2001

**Figure 5-30**  
**Flow Duration Curves for Verdugo- Catchments 120, 121a, 121b, 121c, 122, PA4-4, PA4-5**



## 6 LONG TERM ADAPTIVE MANAGEMENT

This chapter presents the adaptive management approach that will be used to evaluate whether the WQMP elements are functioning as intended and to implement corrective procedures when needed. The issues addressed by this adaptive management approach are management considerations relating to “pollutants of concern” and “hydrologic conditions of concern”.

The adaptive management plan entails the following elements:

- *BMP Inspection and Performance Monitoring.* Routine inspection and monitoring of the combined control system components is required to establish that they are being properly maintained and are functioning as intended.
- *Hydrologic Monitoring.* Routine monitoring of the general hydrologic conditions is needed to ascertain if there are changes in the hydrologic regime and subsequent change to stream stability and geomorphology.
- *WQMP Review and Evaluation.* Annual review of the inspection and monitoring data will be conducted to determine if there is a need for corrective action, to evaluate impacts due to changes in watershed conditions on the hydrologic regime or BMP performance, and in general to evaluate if the WQMP is effective in meeting the planning objectives.
- *Corrective Measures.* Corrective measures will be undertaken for specific problems or conditions of concern identified in the review and evaluation. Depending on the nature of the problem, corrective measures could involve modification of the BMP design, operation, or maintenance, and/or implementation of additional BMPs. The effectiveness of the corrective measures will themselves be evaluated through continued inspection and monitoring. Thus, the management approach is adaptive to specific problems or conditions as they arise and are identified through ongoing inspection, monitoring, documentation, and evaluation.
- *Documentation and Reporting.* Documentation of all operation, maintenance, inspection, and monitoring activities will establish a continuous record of the condition of combined control system facilities and the health of the hydrologic regime. All records will be available to the public and regulatory and resource agencies.

The following sections expand on each of the adaptive management elements.

### 6.1 COMBINED CONTROL SYSTEM COMPONENT INSPECTION AND PERFORMANCE MONITORING

Routine and major operation and maintenance (O&M) activities of the combined control system facilities are described in Section 4.1.4. In conjunction with, or in addition to these O&M activities, performance monitoring of the structural BMPs will be conducted by the HOA or other designated entity. Details of the performance monitoring activities will be included in the project WQMPs. The following sections generally describe the monitoring activities that will be included in the project WQMPs.

### **6.1.1 Wet Weather Monitoring**

*Flow Duration Control and Water Quality Treatment (FD/WQ) Basins* - Grab samples from influent and effluent flows during wet-weather conditions will provide information about the stormwater treatment performance of the FD/WQ basins. Of those WQ basins that discharge to surface receiving waters (as opposed to infiltration basins), grab samples will be collected for two to three storm events per year at representative basins selected on a rotating basis. Grab samples will be analyzed for TSS and possibly other constituents of concern (e.g. metals, nutrients, pathogens). Inlets and outlet areas of all of the FD/WQ basins will be visually inspected monthly during the wet season for signs of clogging, scouring, and sediment accumulation.

*Infiltration Basins* – Infiltration basins will be visually inspected monthly during the wet season, preferably during or soon after a rain event. Percolation rates in the infiltration basins will be determined by measuring the drop in water elevation over the sand bed with time during or after a storm event. Percolation rates will be determined following at least one storm event per year at each basin.

*Swales* – Swales will be visually inspected during wet-weather conditions to verify that there is sufficient capacity to convey storm flows, and to look for signs of scouring; clogging; and sediment, trash, and debris accumulation.

### **6.1.2 Dry Weather Monitoring**

*Flow Duration Control and Water Quality Treatment (FD/WQ) Basins* – Field water quality measurements of influent and effluent dry weather flows will be collected at representative FD/WQ basins. Annual sediment and vegetation monitoring (see Section 4.1.4) will also provide an indication of pollutant removal occurring in the FD/WQ basins' low flow water quality wetlands. Collectively, this information will provide an ongoing record of wetland health and performance and indicate if any further chemical testing may be required at a particular site. Such testing would entail collection of grab samples and laboratory analyses for total nitrogen, coliform bacteria, and other pollutants of concern as warranted.

*Infiltration Basins* – Infiltration basins will be visually monitored to confirm that dry weather flows routed to the infiltration basins are percolating into the subsurface and that there are no dry weather discharges reaching the streams through the bioinfiltration swales.

## **6.2 HYDROLOGIC MONITORING**

Hydrologic monitoring will be performed to determine if there are changes in the hydrologic regime and associated changes in stream stability and geomorphology. To minimize costs, visual observation of direct and indirect indicators will be used where practical. Hydrologic monitoring will include:

*Groundwater levels* – Groundwater levels will be monitored quarterly at existing monitoring wells in the Cañada Gobernadora sub-basin, and at additional monitoring wells to be located in consultation with the management entity responsible for long-term adaptive management of protected habitat areas.

*Base flows* – Dry weather base flows will be spot checked quarterly in sensitive areas through direct or estimated measurements.

*Peak Discharges* – Stormwater peak flows will be estimated through stage measurements or measurements of high water marks. Stream channels will be surveyed annually for visual signs of down cutting or aggradation.

Riparian systems will be monitored as described in Chapter 8 of the Habitat Conservation Plan.

### **6.3 WQMP EVALUATION AND CORRECTIVE MEASURES**

Annual review of the inspection and monitoring data will be conducted to 1) evaluate if the structural BMPs are maintained and functioning properly; 2) to identify water quality concerns or issues; and 3) to identify hydrologic issues of concern and to evaluate whether the BMPs are functioning as intended in terms of hydromodification controls.

Table 6-1 lists general criteria that should be used in the annual review and evaluation. Additional criteria will likely be needed to address specific and unique circumstances as they arise.

BMP modifications and corrective measures will be undertaken to improve performance and remedy any problems that are identified. Selected actions and remedies will be unique to each situation, and in general should be based on a sound understanding of the possible causes and evaluation of alternatives. Table 6-1 identifies potential actions and corrective measures that may be considered. Significant changes to the WQMP proposed as a result of the Adaptive Management Program will be submitted to Orange County for review and approval.

**Table 6-1: Criteria for Review and Evaluation of Monitoring and Inspection Data and Potential Actions and Corrective Measures**

Evaluation Topics and Triggers	Potential Actions & Corrective Measures
<b><i>BMP Status and Sizing</i></b>	
<p><u>BMP Maintenance.</u> Are structural BMPs properly maintained?</p>	<ul style="list-style-type: none"> <li>• Correct maintenance practices and increase management oversight.</li> </ul>
<p><u>BMP Sizing.</u> Are structural BMPs sufficient to address pollutants and hydrologic conditions of concern?</p> <p>Are there any unforeseen or unique changes in the watershed conditions that could potentially increase pollutant loads or runoff?</p>	<ul style="list-style-type: none"> <li>• Review and implement BMPs to address anticipated pollutant loads or runoff.</li> <li>• Continue and possibly increase watershed and BMP monitoring.</li> <li>• Implement additional source control and/or structural BMPs.</li> </ul>
<b><i>Water Quality Treatment</i></b>	
<p><u>FD/WQ Basins.</u> Are the FD/WQ basins providing good water quality treatment performance? This would be evaluated with monitoring data for TSS and other constituents and comparisons with expected effluent quality as determined from information in the National BMP database.</p> <p>Are low flow wetlands in FD/WQ basins healthy in appearance and providing a design level of water quality treatment for dry weather flows? This would be determined through field tests of basic water quality parameters, and possibly through laboratory analysis of grab samples.</p>	<ul style="list-style-type: none"> <li>• Review O&amp;M history of the facility to determine if poor performance is related to inadequate maintenance.</li> <li>• Review monitoring information on sediment accumulation and removals, and influent TSS levels (if available) to evaluate if influent sediment levels are excessive. Review hydrologic monitoring to determine if there are unique or temporary watershed conditions that could lead to excessive sediment loads (e.g. construction activities, fires).</li> <li>• Potential corrective measures include: <ul style="list-style-type: none"> <li>– Review and implement erosion control BMPs to reduce sediment loads</li> <li>– Continue and possibly increase BMP monitoring</li> <li>– Evaluate the facility design and modify if necessary</li> </ul> </li> <li>• Evaluate possible causes of poor performance in the low flow water quality wetlands: <ul style="list-style-type: none"> <li>– Review O&amp;M history of the facility to verify proper maintenance of the facility</li> <li>– Verify adequacy of flows to maintain emergent wetland vegetation</li> <li>– Verify that water levels are not too high</li> <li>– Evaluate facilitate design in terms of flow paths and potential bypassing</li> </ul> </li> <li>• Potential corrective measures for low flow wetland problems include: <ul style="list-style-type: none"> <li>– Correct maintenance deficiencies</li> <li>– Adjust water levels or influent flows</li> <li>– Modify the facility design</li> </ul> </li> </ul>

Evaluation Topics and Triggers	Potential Actions & Corrective Measures
<p><u>Infiltration Basins.</u> Are the infiltration basins functioning properly? i.e., are observed percolation rates equivalent to or in excess of the design rate?</p>	<ul style="list-style-type: none"> <li>• Evaluate possible causes of poor performance: <ul style="list-style-type: none"> <li>– Determine if there is sufficient groundwater capacity</li> <li>– Verify that the flow duration controls (orifices) are designed and functioning properly</li> <li>– Verify that there is adequate pre-treatment of sediments in the water quality basin and that there is no clogging or crusting in the infiltration basin</li> <li>– Review O&amp;M history of the facility to determine if poor performance is related to inadequate maintenance</li> </ul> </li> <li>• Potential corrective measures include: <ul style="list-style-type: none"> <li>– Modify flow duration controls (orifices) in the FD/WQ basin</li> <li>– Correct maintenance deficiencies</li> <li>– Evaluate and modify the design of the infiltration basin</li> <li>– If groundwater capacity is insufficient, evaluate and implement alternative measures for recycling, infiltration, or diversion of excess flows.</li> </ul> </li> </ul>
<p><u>Swales.</u> Are swales functioning as designed? i.e., are wet weather flows properly directed through the swales, with no clogging or bypassing, and with adequate retention time?</p>	<ul style="list-style-type: none"> <li>• Review O&amp;M history of the facility to determine if poor performance is related to inadequate maintenance.</li> <li>• Evaluate sources of runoff and debris. If excessive, evaluate and implement, if necessary, BMPs to reduce sources of runoff and debris.</li> <li>• Evaluate the facility design and sizing. Modify as necessary and practical.</li> </ul>
<b><i>Hydrologic Conditions</i></b>	
<p><u>Elevated Groundwater.</u> Are observed groundwater levels chronically elevated in comparison with pre-development levels? Are maximum groundwater levels maintained 10 ft below infiltration basins?</p>	<ul style="list-style-type: none"> <li>• Adjust flow duration controls (orifices) to reduce diversions to the infiltration basins.</li> <li>• Look for additional opportunities to increase recycling, and/or ET of runoff.</li> <li>• Look for alternative or additional areas suitable for infiltration.</li> <li>• Divert excess flows to less-sensitive sub-basins or channels (e.g. San Juan Creek)</li> </ul>

Evaluation Topics and Triggers	Potential Actions & Corrective Measures
<p><u>Elevated Base Flows.</u> Are base flow discharges or seasonal duration chronically elevated in comparison with pre-development levels? Are changes in base flows having an undesirable effect on stream stabilization or riparian vegetation?</p>	<ul style="list-style-type: none"> <li>• Review adequacy and maintenance of existing dry-weather source control measures. Correct deficiencies as necessary, and look for ways to improve performance of existing source controls.</li> <li>• Look for additional opportunities to reduce dry-weather flows, such as methods to increase ET and recycling.</li> <li>• Divert excess flows to less-sensitive sub-basins or channels (e.g. San Juan Creek)</li> </ul>
<p><u>Elevated Peak Flows.</u> Are estimated peak flows significantly elevated in comparison with pre-development levels? Are wet-weather flows resulting in excessive channel down cutting?</p>	<ul style="list-style-type: none"> <li>• Review adequacy and maintenance of existing wet-weather source control measures. Correct deficiencies as necessary, and look for ways to improve performance of existing source controls.</li> <li>• Look for additional opportunities for wet-weather source control BMPs.</li> <li>• Look for additional opportunities to store wet-weather runoff for non-potable water supplies.</li> <li>• Look for alternative or additional areas suitable for infiltration.</li> <li>• Divert excess flows to less-sensitive sub-basins or channels (e.g. Lower Cristianitos Creek)</li> </ul>

## 6.4 DOCUMENTATION AND REPORTING

An annual summary of all O&M and monitoring activities will be prepared. The summary report shall include:

- BMP construction and maintenance activities, including maintenance logs
- All monitoring information, including watershed, hydrologic, and BMP performance monitoring data
- Findings of the annual evaluation and response, if any.

## **7 IMPACTS OF OTHER ALTERNATIVES**

The SAMP/NCCP Working Group has identified conceptual reserve design alternatives B-4, B-5, B-6, B-8, and B-9 for continuing evaluation in the joint EIS/EIR for the NCCP/HCP and SAMP/MSAA programs. In addition the County of Orange has developed two alternatives for evaluation, the County Environmental Alternative and Regional Housing Alternative. The impacts of the B-4 and B-9 alternatives have been addressed in previous chapters. The purpose of this chapter is to address the impacts of the other alternatives, namely B-5, B-6, B-8, County Environmental Alternative and County Regional Housing Alternative on pollutants and hydrologic conditions of concern.

### **7.1 DESCRIPTIONS OF ALTERNATIVES**

This section presents a brief summary of the various development alternatives for the RMV property based on descriptions developed by the SAMP/NCCP Working Group. Figure 7-1 shows the proposed development areas for each alternative. Table 7-1 provides a breakdown of the proposed development and reserved open space within each sub-basin for each alternative.

**Table 7-1: Development Alternative Land Use Areas by Sub-basin**

Alternative	Land Uses	Land Use Area within Sub-basin (acres)										Total by Land Use
		San Juan Watersheds					San Mateo Watersheds					
		Lower San Juan	Chiquita	Gobernadora	Central San Juan/ Trampas	Verdugo Canyon	Lower Cristianitos	Cristianitos Canyon	Gabino	La Paz Canyon	Blind/ Talega Canyon	
B5	General Development	599	1311	1529	3185	545	0	1	0	0	0	7170
	Open Space	1429	1421	646	1587	1302	287	1274	4360	1365	1974	15645
	Total	2028	2732	2175	4772	1847	287	1275	4360	1365	1974	22815
B6	General Development	599	0	1103	3176	35	150	293	943	0	440	6740
	Open Space	1429	2732	1072	1596	1812	137	982	3417	1365	1534	16075
	Total	2028	2732	2175	4772	1847	287	1275	4360	1365	1974	22815
B8	General Development	599	0	610	2470	0	0	1	0	0	0	3680
	Open Space	1429	2732	1565	2303	1847	287	1274	4360	1365	1974	19135
	Total	2028	2732	2175	4773	1847	287	1275	4360	1365	1974	22815



Alternative	Land Uses	Land Use Area within Sub-basin (acres)										Total by Land Use
		San Juan Watersheds					San Mateo Watersheds					
		Lower San Juan	Chiquita	Gobernadora	Central San Juan/ Trampas	Verdugo Canyon	Lower Cristianitos	Cristianitos Canyon	Gabino	La Paz Canyon	Blind/ Talega Canyon	
B10	Estate			99	5		115	166				385
	Golf Course		158				250	0		225		633
	Golf Resort									25		25
	Golf Residential		211	25								235
	Lake/Dam		17					32				49
	General Development	599	309	937	3265	479	1	16		695	54	6356
	Open Space	1431	2037	1111	1501	1366	878	4178	1365	1030	235	15132
	Total	2030	2733	2173	4770	1846	1275	4360	1365	1974	289	22815
B11	Golf Course						246	3		225		474
	Golf Resort									25		25
	Lake/Dam							32				32
	General Development	599	821	1046	3285	479	247	871		689	53	8090
	Open Space	1431	1910	1129	1485	1366	751	3486	1365	1036	235	14194
	Total	2030	2731	2175	4770	1845	1244	4392	1365	1975	288	22815

### **7.1.1 Alternative B-5**

Alternative B-5 avoids new development within the San Mateo Creek watershed and calls for 7,170 acres of new development located in the following areas (Figure 7-1):

- Within the San Juan watershed -
  - On both sides of Ortega Highway immediately east of the existing residential area in the City of San Juan Capistrano,
  - On the south side of Ortega Highway in the eastern portion of RMV,
  - Chiquita sub-basin,
  - Gobernadora sub-basin, north of San Juan Creek,
  - Trampas and Central San Juan sub-basin, and
  - Verdugo sub-basin.

### **7.1.2 Alternative B-6**

Alternative B-6 would allow new development in those areas in the San Mateo watershed which have been disturbed by past land use practices, but would avoid new development in the Chiquita sub-basin east of Chiquita ridge, Verdugo sub-basin, or around Radio Tower Road (Figure 7-1). The alternative calls for 6,740 acres of new development located in the following areas:

- Within the San Juan watershed -
  - On both sides of Ortega Highway immediately east of the existing residential area in the City of San Juan Capistrano,
  - Gobernadora sub-basin,
  - Trampas and Central San Juan sub-basin, and
  - Along the south side of San Juan Creek, east of Trampas Creek.
- San Mateo Watershed
  - Upper Gabino sub-basin,
  - Cristianitos and Lower Gabino sub-basins, and
  - Talega sub-basin (Northrop-Grumman lease area).

### **7.1.3 Alternative B-8**

Alternative B-8 would allow no new development in the San Mateo watershed, and would restrict new development in the San Juan watershed to primarily areas impacted by current or past land use practices and to the area along the Ortega Highway near the City of San Juan

Capistrano (Figure 7-1). The alternative calls for 3,680 acres of new development located in the following areas:

- Within the San Juan watershed -
  - On both sides of Ortega Highway immediately east of the existing residential areas in the City of San Juan Capistrano,
  - On and adjacent to the existing silica mining site in the Trampas Central San Juan Sub-basin, and
  - In and around the existing nursery and ranching facilities in the Gobernadora sub-basin north of San Juan Creek.

#### **7.1.4 Alternative B-10**

Alternative B-10 is referred to as the “County Environmental Plan” Alternative. This alternative allows for development in the San Juan Creek and San Mateo Creek watersheds. The alternative allows for reduced development in the Cristianitos and Upper Chiquita sub-basins. It avoids future development in the Upper Gabino and La Paz Canyons. The alternative proposes open space in the Upper Verdugo, Upper Cañada Chiquita and Upper Gobernadora sub-basins (Figure 7-1). The alternative calls for a total of 7,683 acres of development consisting of 385 acres of estate housing and 6,356 acres of other proposed development. The alternative also includes 893 acres of golf-related development including 235 acres of golf residential and 25 acres of golf resort. The development areas would be located as follows:

- Within the San Juan Creek watershed -
  - On both sides of Ortega Highway immediately east of the existing residential area in the City of San Juan Capistrano,
  - Chiquita Sub-basin,
  - Gobernadora Sub-basin,
  - Trampas and Central San Juan Sub-basin, and
  - Verdugo Sub-basin.
- Within the San Mateo Creek watershed -
  - Cristianitos Sub-basin (upstream of confluence with Gabino Creek),
  - Gabino Sub-basin,
  - Talega and Blind Sub-basins, and
  - Lower Cristianitos Sub-basin.

### **7.1.5 Alternative B-11**

Alternative B-11 is referred to as the “County Regional Housing” Alternative. The alternative allows for development in the San Juan Creek and San Mateo Creek watersheds. It avoids future development in the Upper Gabino and La Paz Canyon Sub-basins. The alternative proposes open space in the Upper Verdugo, Upper Cañada Chiquita and Upper Gobernadora Sub-basins (Figure 7-1). Additionally the plan allows for the potential avoidance of development in the Middle and Lower Cañada Chiquita Sub-basin and the San Mateo Creek watershed under a Planning Reserve designation. Development is avoided in the northwestern portion of Cristianitos Sub-basin. The alternative calls for a total of 8,621 acres of development. The alternative also includes 499 acres of golf-related including 25 acres of golf resort. The development areas would be located as follows:

- Within the San Juan Creek watershed -
  - On both sides of Ortega Highway immediately east of the existing residential area in the City of San Juan Capistrano,
  - Chiquita sub-basin,
  - Gobernadora sub-basin,
  - Trampas and Central San Juan sub-basin, and
  - Verdugo sub-basin.
- Within the San Mateo Creek watershed -
  - Cristianitos Sub-basin (upstream of confluence with Gabino),
  - Gabino Sub-basin,
  - Talega and Blind Sub-basins, and
  - Lower Cristianitos Sub-basin.

## **7.2 APPROACH TO EVALUATING IMPACTS**

The knowledge and understanding achieved through the analysis of impacts for the B-4 and B-9 alternatives, including hydrologic and water quality modeling, has been used to evaluate the impacts of the other alternatives. This assumes that the proposed development land uses and associated activities, which are not specified in the alternatives are comparable to those in the B-4 and B-9 alternatives.

## **7.3 IMPACTS ASSOCIATED WITH THE B-5 ALTERNATIVE**

### **7.3.1 Effects on Hydrologic Conditions of Concern**

Most of the Central San Juan catchments are in sandy terrains that provide good infiltration capacity with a high loss rate that reflects the shallow slope and broad floodplain valley that facilitates infiltration (PCR et al, 2002). Thus runoff volumes and flows associated with the pre-development condition tend to be relatively low. Because of this, development in sandy soils tend to create larger differences between pre- and post-development runoff volumes and flows. Experience modeling the combined control system for development in sandy soils in Chiquita and Gobernadora indicates that infiltration basins are quite effective in these cases, and reasonably sized basins can control post-development runoff volume. Thus, with controls, development in this area is projected to lead to a small increase in runoff (if any) compared to the pre-development condition.

The significance of a 10 to 20 percent increase in surface runoff volume depends on the sensitivity of the receiving stream. San Juan Creek, downstream of Bell, Lucas, and Verdugo Canyons consists of a meandering river with several floodplain terraces in a wide valley bottom. Increases in runoff from the relatively small tributary drainages will likely not adversely affect the geomorphology of the main stem channel, which is more dictated by the transport and deposition of sediment from the larger upland portion of the watershed. It is possible that an increase in surface flows may actually improve the habitat for the January through June Arroyo Toad breeding and spawning period.

This alternative also calls for additional development in Gobernadora Canyon. Soils in Gobernadora Canyon also tend to be sandy and well drained, except for hardpan and other less infiltrative soils along the ridges, especially to the east. Where development is located on less infiltrative soils, projected runoff will be more similar to pre-development conditions and matching pre-development runoff conditions is more feasible. This is especially so if infiltration basins can be located in the main canyon or side canyons below the ridges where sandy soils dominate. To the extent that the additional development is located on the less infiltrative ridges, it has been shown that the combined control system can be used to match pre-development runoff conditions. For the portion of the development that is located on the canyon floor, conditions are similar to that described above for the Central San Juan sub-basin.

The hydrologic conditions of concern are: increased runoff volumes, flows and durations; changes in infiltration and effects on groundwater recharge; and changes in base flows and effects on habitat. The above analysis would indicate that under some conditions, runoff volumes may increase by 10 to 20 percent, however stream conditions are such that significant changes to the stream equilibrium and geomorphology are not likely. Also, modeling conducted for the B-4 alternative under similar conditions indicates that infiltration is likely to increase because of the utilization of infiltration basins as part of the combined control system. Thus groundwater recharge actually would increase and benefit water supply. This increase would

also tend to increase base flows by between 20 to 80 percent, depending on the time of year and climatic conditions. This level of increase in base flows is not considered sufficient to cause a shift or conversion in the type of habitat, but rather could potentially improve the habitat for selected species such as the Arroyo Toad in the Central San Juan. On the basis of these considerations, the impact of the B-5 Alternative on hydrologic conditions of concern is considered less than significant.

### **7.3.2 Effects on Pollutants of Concern**

The pollutants of concern include TSS; nutrients; potentially toxic constituents such as trace metals, pesticides, hydrocarbons, and chlorine; and trash and debris. These constituents will be addressed through a multi-tiered approach that combines site design, source control, and treatment control, consistent with the Local WQMP requirements. The site design and source control BMPs which would be implemented for the Project as a whole are discussed in Chapter 4. The specific configuration of combined control system facilities will vary depending on proposed land uses and specific environmental conditions in each sub-basin. In this alternative located in a sandy terrain, treatment facilities will be designed to bypass high flows and thereby not interrupt the coarse sediment supply balance that sustains the stream equilibrium. These proposed developments also are underlain in part by Monterey Shale and other formations that may contribute nutrients, especially phosphorous. Treatability depends on the form of the pollutants, and according to the Baseline Report (PCR et al, 2002) heavy loads of fine sediment should favor the adsorbed phases of trace metals and pesticides in the Central San Juan sub-basin. The proposed treatment facilities for this alternative will include wetland treatment for dry weather flows, and detention and infiltration for wet weather flows. To the extent that pollutants are associated with particulates, treatment effectiveness will increase.

The significance criteria for pollutants of concern are: increases in loads and concentration compared to existing conditions; exceedances of regulatory water quality standards, and meeting regulatory requirements for the development and implementation of a WQMP, including the provision for treatment controls that are sized to meet the MEP standard. Based on the modeling results conducted for similar conditions with the B-4 alternative, post-development concentrations tend to decrease with development, whereas post-development loads decrease or increase depending on the pollutant. The modeling results also indicate that projected water quality meets water quality standards for those pollutants having numerical standards. For pollutants without numerical standards, projected water quality is usually as good as if not better than observed in the receiving stream. The WQMP proposed for the project was developed specifically following the Local WQMP requirements and meet the MEP sizing criteria specified in the MS4 Permit. On the basis of these considerations, the impact of the B-5 Alternative, when considering the anticipated treatment effectiveness of the proposed WQMP, on pollutants of concern is considered less than significant.

## **7.4 IMPACTS ASSOCIATED WITH THE B-6 ALTERNATIVE**

The B-6 alternative calls for approximately 6,740 acres of development (Table 7-1). In the San Juan watershed, the B-6 Alternative is similar to the B-5 alternative except that no development would occur in Chiquita and western Gobernadora (this is the area referred to as PA 2 in the B-4 alternative) and only 35 acres of development would occur in Verdugo Canyon. In the San Mateo watershed, proposed development would entail about 1,826 acres intended to be located in areas which have been affected by past land use practices, including areas in the Cristianitos, Gabino, Blind, and Talega sub-basins. These areas are located in approximately the same areas as PAs 7, 8, and 9A under the B-4 alternative and the impacts would be similar in type, if not extent, as described in Chapter 5. Since the major change with the B-6 alternative, compared with the B-5 alternative, is additional development in the San Mateo watershed, the following discussion focuses on this watershed.

### **7.4.1 Effects on Hydrologic Conditions of Concern**

The proposed development in the Cristianitos and Gabino sub-basins would be about 1236 acres. The past land use practices in this area includes clay mining in Cristianitos and Gabino. This is an area with relatively poorly infiltrating soils, so that the pre-development runoff is high relative to areas having more infiltrative capacity. Because of the concern that increased runoff with development could adversely affect the stability of lower Cristianitos Creek, grading would be conducted to route as much of the proposed development in Cristianitos Creek to the Gabino sub-basin. Flow control facilities could be located on the individual development pads, or in one or more of the quarry ponds in Lower Gabino. The quarry ponds reflect groundwater levels and water levels may change as much as 25 feet seasonally. Water in the quarry ponds currently infiltrates into the groundwater; there are no outlets. Given their size, these quarry ponds could potentially serve as flow and water quality control basins, provided there is pretreatment to protect groundwater quality and outlets or bypasses for large runoff events. Such control would help protect the habitat for Arroyo Toads in lower Gabino Creek.

The B-6 alternative includes new development in Upper Gabino in an area that has experienced extensive erosion because of natural erosive conditions coupled with past agricultural practices. Because of a combination of erodible clays and sands, Upper Gabino is a source of fine as well as coarse sediment. The Gabino sub-basin is underlain by clayey and crystalline terrains that generally produce high runoff volumes. So in this case, urbanization may not substantially increase post-development runoff. With development, grading, landscaping, and the incorporation of flow control facilities including recycling of stormwater for irrigation are all factors that would reduce runoff volumes and rates into middle and lower Gabino Creek. Moreover, if development types are similar to the B-4 alternative, the type of development in this area is likely to be less dense with lower impervious areas.

The B-6 alternative also calls for development that would ultimately replace the Northrop-Grumman (formerly TRW) facility. This development bubble would affect approximately 440

acres in Talega Canyon, 150 acres in the lower Cristianitos Creek, and about 30 acres in Lower Gabino. Because of the concern for modifying the hydrologic conditions in Lower Talega, which supports a large population of arroyo toads, the portion of the development area in the Talega sub-basin would be routed either north to Blind Canyon or west to Lower Cristianitos. Under this routing plan, the post-development hydrologic conditions within Talega would approximate the pre-development condition. Flow control would be implemented on the individual development pads or in Blind Canyon in order to preserve arroyo toad habitat in lower Cristianitos Creek.

The hydrologic conditions of concern are: increased runoff volumes, flows and durations; changes in infiltration and effects on groundwater recharge; and changes in base flows and effects on habitat. Post-development runoff can be controlled to closely match pre-development conditions. For example, the proposed utilization of quarry ponds, if properly modified, could be quite effective in reducing post-development runoff. With respect to effect on habitat, this alternative focuses development in the San Mateo watershed only in areas where past land use practices have compromised the habitat, and the proposed development will help restore some habitat. Also this alternative calls for grading areas so that runoff is directed away from sensitive habitats. On the basis of these considerations, the impact of the B-6 Alternative on hydrologic conditions of concern is considered less than significant.

#### **7.4.2 Impacts on Pollutants of Concern**

The WQMP for this alternative would include the site design, source control, and treatment concepts that have been described above and in Chapter 4. For the proposed developments in the San Mateo watershed, soil and channel substrate conditions tend to be more erodible clays and silts and therefore there is the potential for increased fines to be discharged if development increases runoff flows. Combined control system facilities would be tailored to sub-basin conditions, and for this alternative would take advantage of quarry ponds in Lower Gabino that could be modified to provide water quality treatment. Such ponds could potentially provide sufficient detention time to effectively treat the fines and associated pollutants. Treatment facilities for the proposed development of the TRW area would be located in lower Blind Canyon and would include wetlands for treating low flows, and detention and infiltration for treating storm flows. Consistent with stormwater practices in meeting the MEP standard, facilities would be sized to capture the majority of the mean annual runoff, with bypass facilities provided for large, infrequent events (e.g., 10 to 100 year storms).

The significance criteria for pollutants of concern are: increases in loads and concentration compared to existing conditions; exceedances of regulatory water quality standards, and meeting regulatory requirements for the development and implementation of a WQMP, including the provision for treatment controls that are sized to meet the MEP standard. Although quantitative analysis has not been conducted for this alternative, the modeling conducted under the B-4 alternative addressed similar areas to those proposed under this alternative, including areas in the



San Mateo watershed. Those results indicate that the impacts of this alternative, when considering the WQMP, on pollutants of concern is considered less than significant.

## **7.5 IMPACTS ASSOCIATED WITH THE B-8 ALTERNATIVE**

The B-8 alternative would involve approximately 3,680 acres of new development, all of which would be located in three development bubbles: Ortega Gateway primarily in Narrow Canyon, Gobernadora Canyon, and Central San Juan/Trampas Canyon (Figure 7-1). These three development bubbles are very similar to PAs 1, 3 and 5 in the B4 alternative. The potential effects of these development bubbles have been addressed in Chapters 5. About two-thirds of the total proposed developed area or 2,470 acres would be located in Central San Juan/Trampas. This is primarily a sandy terrain where, as discussed above, matching of pre-development hydrologic conditions is difficult because pre-development runoff is quite low. However, hydrologic modeling in similar terrains has indicated that infiltration basins can achieve 80 to 90 percent reduction in post-development runoff. The modest 10 to 20 percent increases can generally be accommodated in central San Juan Creek, whose geomorphology is governed by larger scale watershed conditions.

On the basis of the above considerations, the impact of the B-8 Alternative on hydrologic conditions of concern is considered less than significant.

The WQMP for this alternative would include the site design, source control, and treatment concepts that have been described above and in Chapter 4. Combined control system facilities in this sandy terrain area include detention and infiltration, the latter of which takes advantage of the infiltrative soils. The combination of detention followed by infiltration provides effective treatment for most pollutants associated with urbanization, including phosphorous that may be elevated by natural sources and other pollutants that tend to partition to particulates.

On the basis of the above considerations, the impact of the B-8 Alternative on pollutants of concern is considered less than significant.

## **7.6 IMPACTS ASSOCIATED WITH THE REGIONAL HOUSING PLAN ALTERNATIVE**

The B-10 alternative calls for approximately 7,683 acres of development (Table 7-1). The B-10 alternative is very similar to the B-9 alternative except that there would be a 250 acre golf course and 115 acres of estate housing in the Cristianitos Sub-basin and 166 acres of estate housing in the Gabino Sub-basin. Since the major change with the B-10 alternative, compared with the B-9 alternative, is additional estate development in the San Mateo watershed, the following discussion focuses on the estate development.

### 7.6.1 Effects on Hydrologic Conditions of Concern

The proposed estate development in the Cristianitos and Gabino Sub-basins would be about 281 acres. The past land use practices in this area includes clay mining in Cristianitos and Gabino Sub-basins. This is an area with relatively poorly infiltrating soils, so that the pre-development runoff is high relative to areas having more infiltrative capacity. Estate housing in the Cristianitos Sub-basin is located in the northwestern portion of the sub-basin upgradient of the proposed golf course. In lieu of infiltration, the flow management plan would propose to treat and store excess runoff for non-potable supply including irrigation water for the golf course. Treatment and storage could be integrated into the water features of the golf course. Alternatively, because the estate housing is quite low density, low impact site design control options could be utilized. Such options could include utilization of vegetated swales rather than traditional curb and gutter designs.

Runoff from the 166 acres of estate housing planned for the Gabino Sub-basin could be managed with infiltration facilities given that soils are primarily sandy loam in this portion of the Gabino Sub-basin. Alternatively flow control facilities could be located in one or more of the quarry ponds in Lower Gabino. The quarry ponds reflect groundwater levels and water levels may change as much as 25 feet seasonally. Water in the quarry ponds currently infiltrates into the groundwater; there are no outlets. Given their size, these quarry ponds could potentially serve as flow and water quality control basins, provided there is pretreatment to protect groundwater quality and outlets or bypasses for large runoff events. Such control would help protect the habitat for Arroyo Toads in lower Gabino Creek.

The hydrologic conditions of concern are: increased runoff volumes, flows and durations; changes in infiltration and effects on groundwater recharge; and changes in base flows and effects on habitat. Post-development runoff can be controlled to closely match pre-development conditions. For example, the proposed utilization of quarry ponds, if properly modified, could be quite effective in reducing post-development runoff. With respect to effect on habitat, this alternative focuses development in the San Mateo Creek watershed only in areas where past land use practices have compromised the habitat, and the proposed development will help restore some habitat. On the basis of these considerations, the impact of the B-6 alternative on hydrologic conditions of concern is considered less than significant.

### 7.6.2 Impacts on Pollutants of Concern

The WQMP for this alternative would include the site design, source control, and treatment concepts that have been described above and in Chapter 4. For the proposed estate developments in the San Mateo Creek watershed, soil and channel substrate conditions tend to be more erodible clays and silts and therefore there is the potential for increased fines to be discharged if development increases runoff flows. Combined control system facilities would be tailored to sub-basin conditions, and for this alternative would take advantage of quarry ponds in Lower Gabino that could be modified to provide water quality treatment. Such ponds could potentially

provide sufficient detention time to effectively treat the fines and associated pollutants. In the Cristianitos Sub-basin, the combined control system would take advantage of the potential to treat, store, and recycle runoff for irrigating the proposed golf course.

The significance criteria for pollutants of concern are: increases in loads and concentration compared to existing conditions; exceedances of regulatory water quality standards; and meeting regulatory requirements for the development and implementation of a WQMP, including the provision for treatment controls that are sized to meet the MEP standard. Although quantitative analysis has not been conducted for this alternative, the modeling conducted under the B-9 alternative addressed similar areas to those proposed under this alternative, including areas in the San Mateo watershed. Those results indicate that the impacts of this alternative, when considering the WQMP, on pollutants of concern is considered less than significant.

## **7.7 IMPACTS ASSOCIATED WITH THE B-11 ALTERNATIVE**

The B-11 alternative calls for approximately 8,621 acres of development including the planning reserve (Table 7-1). It is very similar to the B-10 alternative except for a planning reserve that could affect future development in the San Mateo Creek watershed and in the middle portion of the Chiquita Sub-basin. Since the distinctive feature of this alternative is the planning reserve, the following discussion focuses on the development areas that are covered by the planning reserve.

### **7.7.1 Effects on Hydrologic Conditions of Concern**

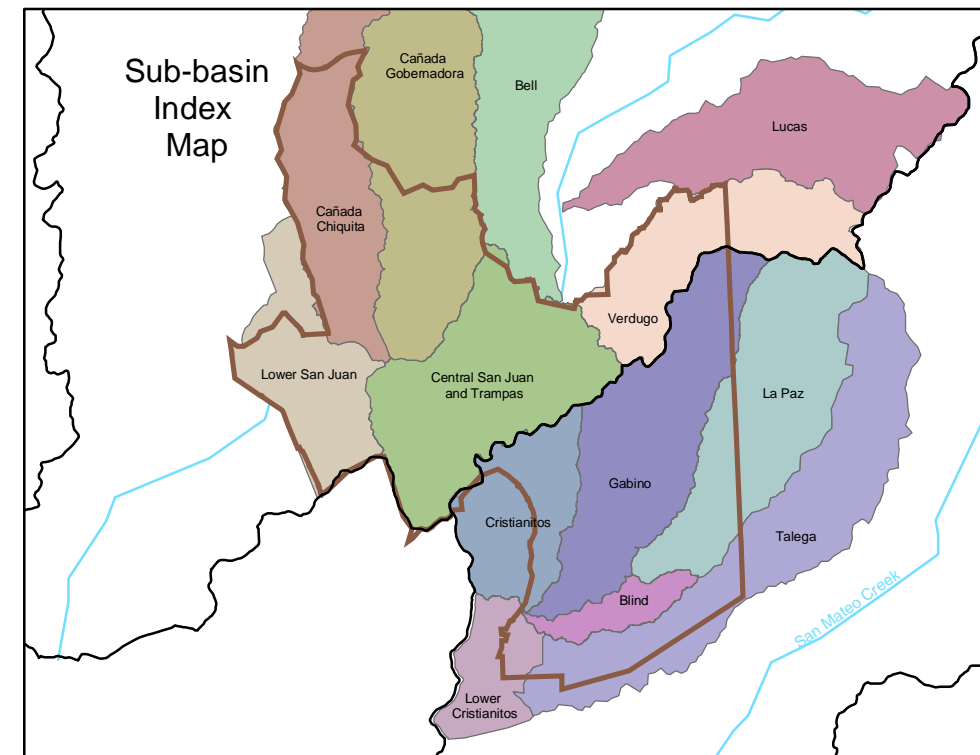
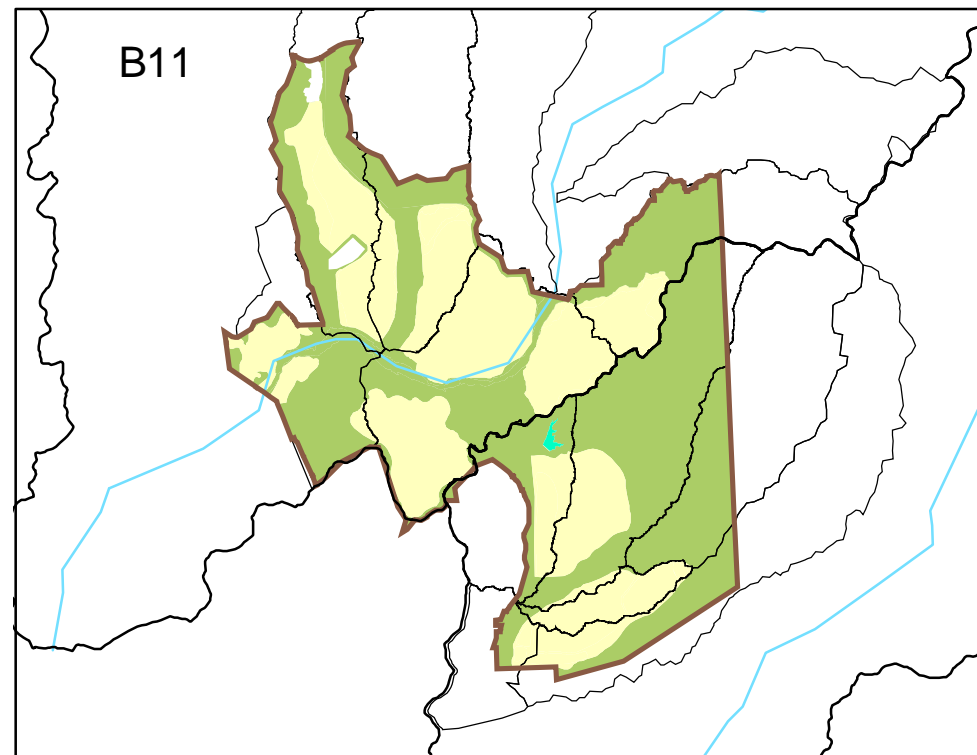
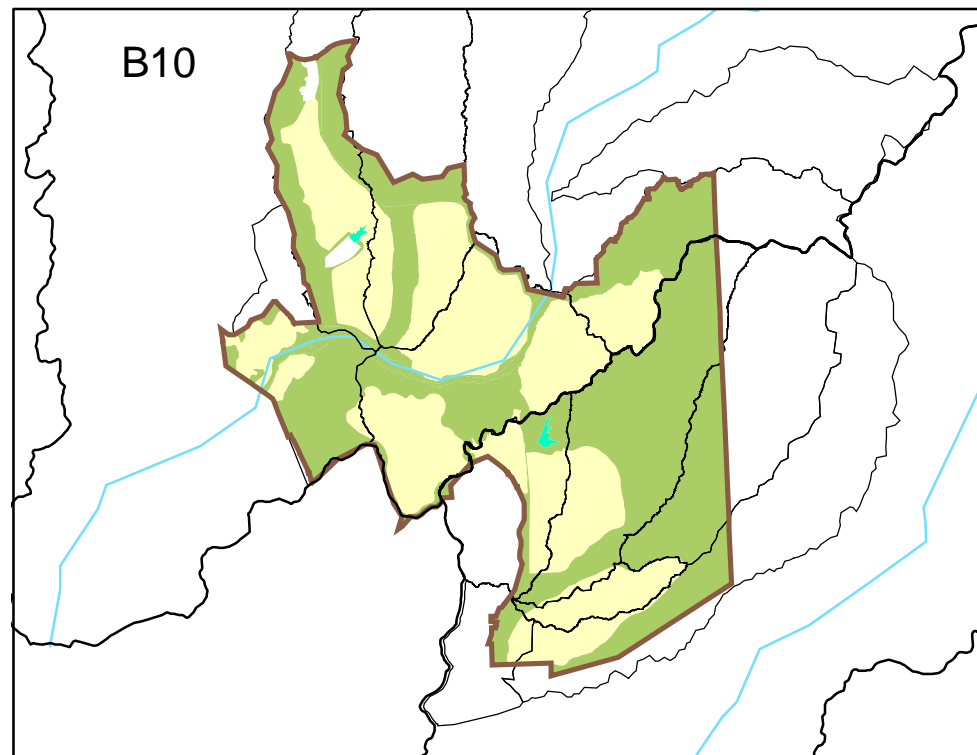
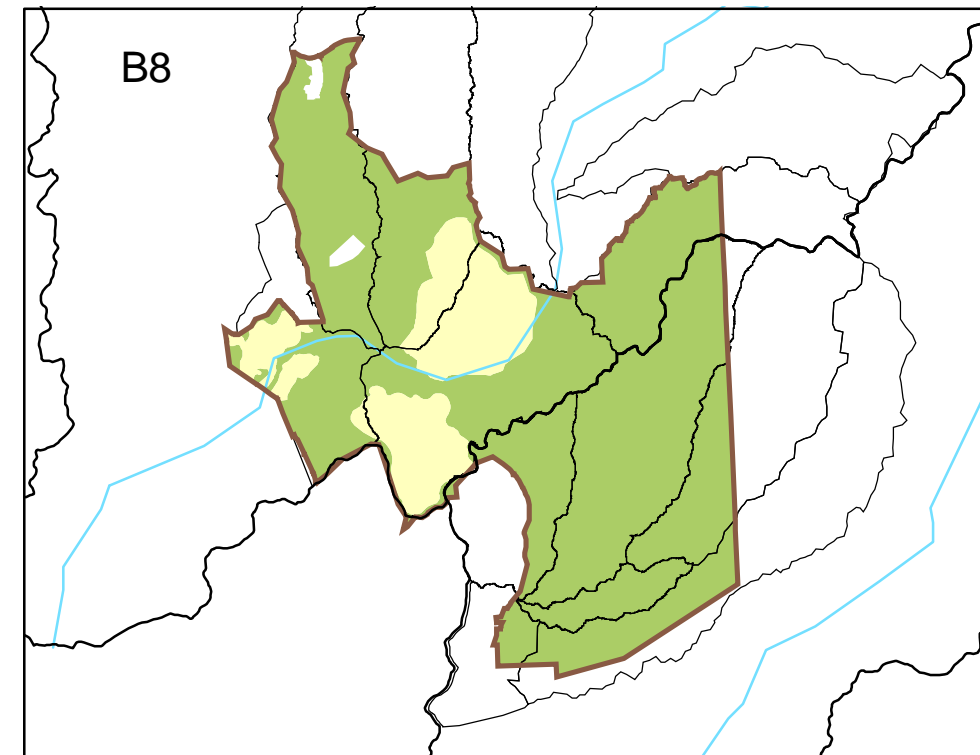
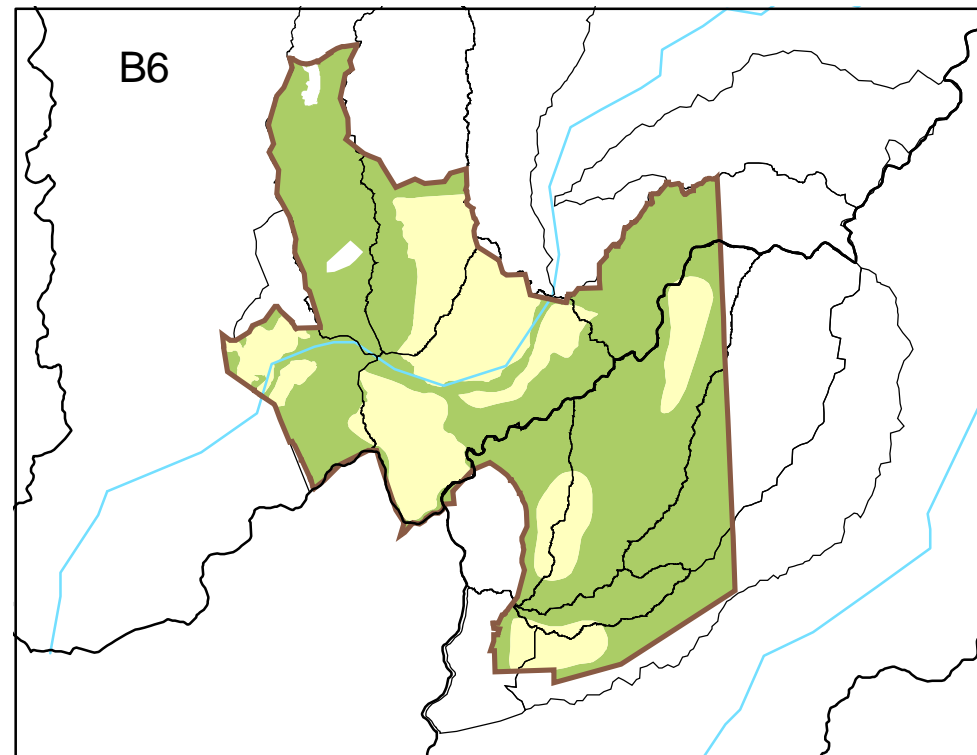
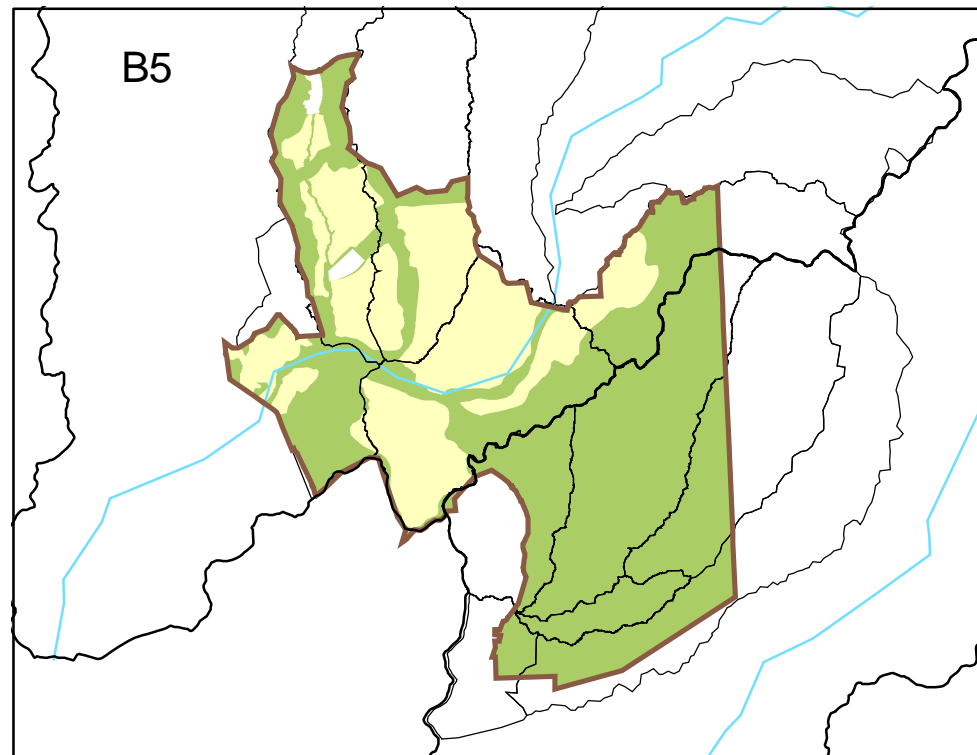
The middle portion of the Chiquita Sub-basin (north of the WWTP) is in the planning reserve. This area is underlain by sandy alluvial deposits that provide good infiltration capacity and facilitates the utilization of infiltration basins for flow duration control. Modeling conducted for the B4 Alternative verified that a combined control system could effectively mimic pre-development flow duration and water balance conditions.

In the San Mateo Creek watershed, the planning reserve would encompass the proposed development bubble in the Cristianitos and Gabino Sub-basins, and the development bubble that would cover portions of Talega and Blind Canyons and the Lower Cristianitos Sub-basin. The effects of development of the Cristianitos/Gabino bubble (PA 7) has been addressed and modeled under the B4 alternative, whereas proposed development in the Talega and Blind Sub-basins (PA 8) has been addressed in both the B-4 and B-9 modeling. The results of that work indicate that there are ample opportunities and options for effective flow duration control, and on this basis, the impact of the B-11 alternative on hydrologic conditions of concern is considered less than significant.

### **7.7.2 Impacts on Pollutants of Concern**

The WQMP for this alternative would include the site design, source control, and treatment concepts that have been described in Chapter 4. Although quantitative analysis has not been

conducted for this alternative, the modeling conducted under the B-4 and B-9 alternatives addressed similar areas to those proposed under this alternative, including areas in the San Mateo watershed. Those results indicate that the impacts of this alternative, when considering the WQMP, on pollutants of concern are considered less than significant.



**Legend**

- Planning Area
- Open Space
- Proposed Reservoir
- Stream
- Road
- Sub-basin Boundary
- Rancho Mission Viejo Boundary
- San Juan and San Mateo Watershed Boundaries

0 30,000  
Feet

**Figure 7-1**  
**Alternate Planning Area Maps**

March 2004	Water Quality Management Plan Rancho Mission Viejo	
------------	---	--

## **8 CUMULATIVE IMPACT ANALYSIS**

This chapter addresses the cumulative effects of the proposed project in the San Juan Creek watershed and the San Mateo Creek watershed. The analysis was conducted by aggregating the results of the sub-basin modeling results for the B-4 and B-9 alternatives provided in Chapter 5. For the B-9 alternative, modeling was conducted only for those planning areas (PA 4 and PA 8) that were substantially different from the comparable planning areas for the B-4 alternative. For modeled planning areas other than PA 4 and PA 8, the runoff and pollutant load estimates for the B-9 alternative were assumed to be identical to that for the B-4 alternative. This is somewhat conservative in that the development areas for the B-4 alternative are larger than those for the B-9 alternative. For the two planning areas that were not modeled for either alternative (PA 1 and PA 9), runoff and load estimates were made based on area-scaling of the modeled results from other representative planning areas.

### **8.1 SAN JUAN CREEK WATERSHED**

The cumulative impacts of the proposed project in the San Juan Creek watershed were assessed by comparing the estimated increases in mean annual flows and pollutant loads generated by the project with the mean annual flows and loads calculated from monitoring data collected at the downstream gauging station at La Novia. The available monitoring data at this station is the most comprehensive of any downstream gauging station and therefore provides the best opportunity for assessing cumulative project effects on existing conditions.

It is important to note however that the gauging information only addresses the surface water component of the aquifer water balance and what flows past the gauges is a combination of (a) flow on the surface, (b) flow below the surface, and (c) what has been withdrawn from the alluvial aquifer upstream of the gauges. Although data on items (b) and (c) are limited, the importance of these elements of the overall water balance is discussed as it provides the appropriate context for the cumulative impact analysis.

#### **8.1.1 Stormwater Runoff Volume**

The La Novia gauging station is located about one mile downstream of RMV and just upstream of the I-5 freeway in the City of the San Juan Capistrano (Figure 1-7). The USGS maintains a streamflow gauging station at this location (Station No. 11046530) from which average daily discharge measurements for a period of 17 years (WY 1987-2002) were obtained. These data show that stream flows are ephemeral at this location, with frequent zero readings in late summer and early fall.

The daily discharge data were analyzed to estimate the mean annual stormwater runoff volumes for the 17 year record. A review of the data indicated that one cfs was an appropriate cutoff to distinguish between dry weather base flows and stormwater flows. The average annual stormwater runoff volume for WY 1987-2002 is approximately 16,000 acre-ft/yr. Most of the available stream gauging data were collected during the wet period trend from WY 1991-2001,

including the very wet years in 1995 and the El Nino water year 1998. Thus the data set is more representative of runoff during above average rainfall conditions.

Figure 8-1 illustrates the changes in the estimated annual stormwater runoff volumes from each sub-basin in the San Juan Creek watershed resulting from the proposed project. The total cumulative change in stormwater runoff volume along San Juan Creek is based on summing the sub-basin contributions. Note that the runoff contributions from the project do not include runoff from the existing developed areas in Coto de Caza and Wagon Wheel as this is an existing offsite condition. The effects of Coto de Caza, which was initially developed in the 1960's, on runoff are incorporated in the measured gauge flows at La Novia. The total cumulative runoff volume below RMV is compared with the estimated annual stormwater runoff at the La Novia Station in Table 8-1. This comparison shows that the increase in runoff volumes from the proposed alternatives with PDFs is about two percent of the average annual storm runoff at La Novia.

**Table 8-1: Comparison of Estimated Average Annual Stormwater Volumes at the La Novia Gauging Station and the Estimated With-Project Cumulative Increase in Flows Below RMV**

<b>Alternative</b>	<b>Period of Record of Measured Data at La Novia Gauge</b>	<b>Estimated Average Annual Stormwater Volume at La Novia based on Observations<sup>1</sup> (acre-ft/yr)</b>	<b>Change in Annual Volume below RMV with Project<sup>2</sup> (acre-ft/yr)</b>	<b>Change in Annual Stormwater Volume below RMV as % of Volume at La Novia</b>
B4	WY 1987-2002	15982	332	2.1%
B9	WY 1987-2002	15982	312	2.0 %

<sup>1</sup>Estimated based on 17 years of measured daily flow data (WY 1987-2002).

<sup>2</sup>Estimated based on 53 year precipitation record and SWMM modeling (WY 1949-2001).

### **8.1.2 Stormwater Runoff Pollutant Loads and Concentrations**

The OCPFRD has collected wet-weather water quality monitoring data at La Novia since 1991 (see Section 1.7.4). Average concentrations of stormwater monitoring data at the La Novia Station shown in Table 8-2 were used to estimate average annual stormwater loads at the La Novia Station.

**Table 8-2: Average Stormwater Pollutant Concentrations from OCPFRD Monitoring at the La Novia Station used to Estimate Average Annual Pollutant Loads.**

	TSS (mg/L)	Nitrate-N (mg/L)	Phosphate-P (mg/L)	Dissolved Copper (ug/L)	Dissolved Lead (ug/L)	Dissolved Zinc (ug/L)
Sample Years	1991-1999	1991-1999	1991-1999	2001-2002	2001-2002	2001-2002
No. of Samples	43	15	15	16	16	16
No. of Non-Detects	1	0	0	1*	16*	9*
Average Concentration	326	1.2	0.6	6.2	2.0	11.4

\* The method detection limit (MDL) value was used for reported values below the MDL.

The estimated annual stormwater loads in the San Juan Watershed resulting from the proposed project are compared with the estimated average annual loads at the La Novia Station in Table 8-3 and Figure 8-2. Table 8-3 shows that the estimated average annual TSS and nitrate-nitrogen loads decrease by about two to three percent for both alternatives. Total phosphorus loads are estimated to increase by less than two percent for both alternatives.

**Table 8-3: Average Annual Stormwater Loads and Concentrations at the La Novia Gauging Station and Cumulative Increase in Loads and Concentrations from Project Based on Modeling**

Parameter	Estimated Loads			Estimated Concentration			
	Existing Average Annual Load at La Novia	Estimated Cumulative Change in Loads at La Novia	Change in Loads below RMV as % of Loads at La Novia	Existing Average Storm Concn. at La Novia	Average Storm Concn. at La Novia with Project	Estimated % Change in Storm Concn. with Project	CTR Criteria at hardness of 120 mg/L
<b>ALTERNATIVE B-4</b>							
TSS	7084 (tons)	-130 (tons)	-1.8%	326 (mg/L)	314 (mg/L)	-3.8%	
Nitrate-N	52151 (lbs)	-1277 (lbs)	-2.4%	1.2 (mg/L)	1.15 (mg/L)	-4.4%	
Phosphate-P	26076 (lbs)	283 (lbs)	1.1%	0.6 (mg/L)	0.59 (mg/L)	-1.0%	
Diss. Copper	270 (lbs)	15 (lbs)	5.6%	6.2 (ug/L)	6.4 (ug/L)	3.4%	15.9 (ug/L)
Diss. Lead	87 (lbs)	5 (lbs)	5.8%	2 (ug/L)	2.1 (ug/L)	3.7%	78.7 (ug/L)
Diss. Zinc	497 (lbs)	34 (lbs)	6.9%	11.4 (ug/L)	12.0 (ug/L)	4.8%	137 (ug/L)
<b>ALTERNATIVE B-9</b>							
TSS	7084 (tons)	-151 (tons)	-2.1%	326 (mg/L)	313 (mg/L)	-4.0%	
Nitrate-N	52151 (lbs)	-1444 (lbs)	-2.8%	1.2 (mg/L)	1.14 (mg/L)	-4.6%	
Phosphate-P	26076 (lbs)	412 (lbs)	1.6%	0.6 (mg/L)	0.60 (mg/L)	-0.3%	



Parameter	Estimated Loads			Estimated Concentration			
	Existing Average Annual Load at La Novia	Estimated Cumulative Change in Loads at La Novia	Change in Loads below RMV as % of Loads at La Novia	Existing Average Storm Concn. at La Novia	Average Storm Concn. at La Novia with Project	Estimated % Change in Storm Concn. with Project	CTR Criteria at hardness of 120 mg/L
Diss. Copper	270 (lbs)	17 (lbs)	6.3%	6.2 (ug/L)	6.5 (ug/L)	4.3%	15.9 (ug/L)
Diss. Lead	87 (lbs)	7 (lbs)	7.9%	2 (ug/L)	2.1 (ug/L)	5.9%	78.7 (ug/L)
Diss. Zinc	497 (lbs)	31 (lbs)	6.2%	11.4 (ug/L)	11.9 (ug/L)	4.2%	137 (ug/L)

Dissolved metal loads are estimated to increase by about six to eight percent for both alternatives. Average trace metal concentrations at La Novia are projected to increase only slightly and are well below the CTR criteria calculated at a hardness value of 400 mg/L (Table 8-4). Actual monitoring data at La Novia show hardness values consistently greater than 400 mg/L.

**Table 8-4: Comparison of Estimated Average Trace Metal Concentrations Below RMV and at La Novia with the CTR Criteria.**

Parameter	Units	Average Concentration At La Novia Without Project <sup>1</sup>	Average Concentration At La Novia With Project <sup>2</sup>	CTR Criteria at hardness of 400 mg/L
Dissolved Copper	(ug/L)	6.2	8.9	50
Dissolved Lead	(ug/L)	2.0	3.1	280
Dissolved Zinc	(ug/L)	11.4	10.2	380

<sup>1</sup>Estimated from available monitoring data (see Table 2)

<sup>2</sup>Estimated by added the incremental change in concentration below RMV to average concentrations from observed monitoring at La Novia

## 8.2 SAN MATEO CREEK WATERSHED

The cumulative impacts of the proposed project in the San Mateo Creek watershed were assessed by comparing the estimated flows and pollutant concentrations generated by the project with those calculated from available monitoring data in Lower Cristianitos Creek and San Mateo Creek.

### 8.2.1 Stormwater Runoff Volumes

Average daily discharge data downstream of RMV are available from three USGS gauging stations. Table 8-5 summarizes the estimated average annual runoff at these stations based on the daily flow information. As in the San Juan Creek watershed, only flows above one cfs were assumed to be stormwater related. Two of the stations were located on Cristianitos Creek not far downstream of RMV. The third station is located on the main stem of San Mateo Creek near I-5

and the coast. The periods of record for the data at each gauge vary and the records reflect either dry or wet periods as indicated in the table. Most of the available stream gauging data at the Cristianitos Creek below Talega Gauge and San Mateo Creek gauge was collected during periods of below average rainfall (dry periods) as defined in Figure 1-5, resulting in relatively low runoff volumes. The lower station on Cristianitos Creek was in operation during extremely wet years in 1995 and 1998 and consequently this gauge shows higher runoff than the downstream San Mateo Creek gauge. For the purpose of developing a benchmark condition representative of a mix of dry and wet years, annual estimates of runoff from the two gauges in Lower Cristianitos Creek were pooled to provide an approximate estimate of average runoff of 2,000 acre-ft/yr.

Review of the gauging data indicated that during certain conditions the flow at the San Mateo Creek gauge was actually less than the corresponding flow at the upstream Cristianitos gauge. This occurs because the alluvial aquifer system is pumped to irrigate crops on leased lands along San Mateo and Cristianitos Creek and for water supply for Camp Pendleton. The volumes of water utilized by agriculture and Camp Pendleton are uncertain, however, based on the area under cultivation, agricultural pumpage is probably in the low thousands of acre feet per year.

**Table 8-5: Average Annual Stormwater Runoff Volumes at USGS Gauging Stations in the San Mateo Watershed.**

USGS Gauge Number	Gauge Location	Drainage Area (square miles)	Period of Record	Dry / Wet Period Data	Average Annual Stormwater Flows (AF/yr)
11046350	Cristianitos Crk Below Talega	29	WY 1951-67	Dry	1100
11046360	Cristianitos Crk Above San Mateo	31.6	WY1994-2002	Wet	3580
11046370	San Mateo Crk at I-5	132	WY 1947-67, WY1984-85	Dry	2830

The estimated increase in the mean annual stormwater runoff volumes in the San Mateo Creek watershed resulting from the proposed project are shown in the form of “stick diagrams” for the B-4 and B-9 alternatives in Figure 8-3. The values are in acre-ft and reflect the estimated increase in runoff from each sub-basin. The increases in runoff volume from each sub-basin are accumulated along the main stem of Cristianitos Creek. These values then represent the cumulative increase in mean annual runoff volume in acre-ft.

Table 8-6 compares the existing runoff volume based on the USGS data with the estimated cumulative increase in runoff volumes from the proposed project. The USGS data used in the table is for the Cristianitos Creek data only. The B-4 alternative is estimated to increase runoff volumes in lower Cristianitos Creek by about 480 acre-ft/yr or 24 percent. The primary

contributing sub-basin to this increase is Lower Gabino (Figure 8-3). However, as discussed above, this volume is small compared to the annual volumes of water extracted from the aquifer for water supply purposes. Therefore the increased surface water flows are considered a benefit to providing additional surface flows in a system that is heavily pumped.

The B-9 alternative is projected to increase runoff in Lower Cristianitos Creek by less than one percent. The limited increase in runoff under the B-9 alternative is mainly due to the lack of development in the Cristianitos and Lower Gabino sub-basins (PA 7).

**Table 8-6: Estimated Project Effects on Average Annual Stormwater Runoff Volumes**

Alternative	Period of Record of Measured Data at Lower Cristianitos Creek Gauges	Estimated Average Annual Stormwater Volume based on Observations <sup>1</sup> (acre-ft/yr)	Change in Annual Volume below RMV with Project <sup>2</sup> (acre-ft/yr)	Change in Annual Stormwater Volume below RMV as % of Volume at Lower Cristianitos
B4	WY 1951-1967 WY 1994-2002	2000	482	24%
B9	WY 1951-1967 WY 1994-2002	2000	1	0.1 %

<sup>1</sup>Based on pooled USGS monitoring data at 2 Lower Cristianitos Creek gauges (see Table 8-5).

<sup>2</sup>Based on modeling results for 53 year period of record (WY 1949-2001).

### **8.2.2 Stormwater Runoff Pollutant Loads and Concentrations**

There is very little stormwater quality monitoring data available in the San Mateo Creek watershed. RMV has recently initiated stormwater monitoring, and the limited data are described in Section 1.7.4. One of the RMV stations (SW-8) is located on Cristianitos Creek, below Gabino Creek and above Talega Creek. Water quality monitoring data from this station were used to assess impacts of the proposed project.

The estimated increases in average annual stormwater pollutant loads in the San Mateo Creek watershed resulting from the proposed project are shown in Figure 8-4. The cumulative increases along the main stem of Lower Gabino Creek and Lower Cristianitos Creek are also shown. Both the B-4 and B-9 alternatives exhibit relatively small estimated increases in cumulative pollutant loads, and in some cases reductions in cumulative pollutant loads, especially with Alternative B-9. This occurs because of the use of infiltration BMPs and runoff recycling where feasible, both of which effectively reduce pollutant loads. Also, there is a moderate amount of existing development in Blind Canyon and Talega Canyon (Northrop Grumman), which was modeled as a light industrial land-use. Pollutant concentrations from light industrial development are greater than from residential development (based on LA County monitoring information), and therefore the modeled land use type changes in these areas result in reduced loads under post-development.

Table 8-7 compares the estimated existing loads at SW-8, based on RMV monitoring information, with the estimated cumulative increase in loads from the proposed project based on the modeling. Under the B-4 alternative, TSS and nutrient loads in Lower Cristianitos Creek are estimated to increase slightly, while TSS and nutrient concentrations are estimated to decrease due to dilution with increased runoff volumes. Estimated changes in metal loads vary from a reduction of 16 percent for lead to an increase of about 80 percent for copper. However, concentrations in Lower Cristianitos Creek exhibit small increases, and in all cases are well below the CTR criteria calculated at a conservative hardness value of 120 mg/L.

Results for the B-9 alternative exhibit smaller impacts than Alternative B-4. Reasons for this are the reduced scope of the development plan, the use of infiltration BMPs and runoff recycling, and because of the land-use type changes in the development area.

**Table 8-7: Estimated Changes in Pollutant Loads and Concentrations at SW-8.**

Parameter	Estimated Loads			Estimated Concentrations			
	Existing Annual Load at SW-8	Estimated Cumulative Change in Loads at SW-8	Change in Loads below RMV as % of Loads at SW-8	Existing Average Concn. at SW-8	Average Concn. at SW-8 with Project	Estimated % Change in Concn. with Project	CTR Criteria at hardness of 120 mg/L
<b>ALTERNATIVE B-4</b>							
TSS	12963 (tons)	0 (tons)	0%	4767 (mg/L)	3852 (mg/L)	-19.2%	
Nitrate-N	3263 (lbs)	292 (lbs)	9%	0.6 (mg/L)	0.53 (mg/L)	-11.6%	
Phosphate-P	3481 (lbs)	338 (lbs)	10%	0.64 (mg/L)	0.57 (mg/L)	-11.5%	
Dissolved Copper	35 (lbs)	10 (lbs)	29%	6.5	6.7 (ug/L)	2.5%	15.9 (ug/L)
Dissolved Lead	3.2 (lbs)	2.6 (lbs)	81%	0.58	0.8 (ug/L)	46.1%	78.7 (ug/L)
Dissolved Zinc	63 (lbs)	-10 (lbs)	-16%	11.5	7.8 (ug/L)	-32.2%	137 (ug/L)
<b>ALTERNATIVE B-9</b>							
TSS	12963 (tons)	-15 (tons)	-0.1%	4767 (mg/L)	4759 (mg/L)	-0.2%	
Nitrate-N	3263 (lbs)	-35 (lbs)	-1.1%	0.6 (mg/L)	0.59 (mg/L)	-1.1%	
Phosphate-P	3481 (lbs)	-10 (lbs)	-.3%	0.64 (mg/L)	0.64 (mg/L)	0.2%	
Dissolved Copper	35 (lbs)	-2 (lbs)	-6%	6.5 (ug/L)	6.1 (ug/L)	-5.6%	15.9 (ug/L)
Dissolved Lead	3 (lbs)	-0.8 (lbs)	-27%	0.58 (ug/L)	0.4 (ug/L)	-26.6%	78.7 (ug/L)
Dissolved Zinc	63 (lbs)	-47 (lbs)	-75%	11.5 (ug/L)	2.9 (ug/L)	-74.6%	137 (ug/L)

Collectively, analyses described above indicate that regional treatment BMPs would limit cumulative increases in runoff volumes to moderate levels (about 20 to 30 percent) and would effectively control pollutant loads and concentrations.

### **8.3 FINDINGS OF SIGNIFICANCE**

The following are the findings of significance with regard to the cumulative impacts of Alternative B-4 and Alternative B-9 in the San Juan Creek watershed and the San Mateo Creek watershed.

#### **8.3.1 San Juan Creek Watershed**

In the San Juan Creek watershed, the projected increase in mean annual runoff at the La Novia bridge is about 2 percent for the B-4 and B-9 alternatives. This increase does not take into account the runoff from existing upland development in Coto de Caza and Wagon Wheel, and would be less if these areas were included in the analysis. The additional stormwater flows, although modest, along with the dry weather base flow contributions would benefit the system by replenishing the aquifer, especially during dry years, and would help support arroyo toads breeding downstream of the “key location”. On this basis, the cumulative impact of the proposed development under the B-4 and B-9 alternatives on flows in San Juan Creek is considered less than significant.

Projected changes in pollutant loads in the San Juan Creek watershed vary depending on pollutant. For TSS, pollutant loads are projected to decrease by about two percent for both the B-4 and B-9 alternatives. For nutrients, nitrate-nitrogen loads are projected to decrease by about 2.5 percent, whereas phosphate loads are projected to increase by about one to 1.5 percent. Nutrient concentrations are projected to decrease and therefore algal growth should not be stimulated with development. Trace metal loads are projected to increase by about five to eight percent depending on constituent and the alternative. Trace metal concentrations however are well below CTR criteria. On this basis, the cumulative effect of the proposed development under the B-4 and B-9 alternatives is considered less than significant.

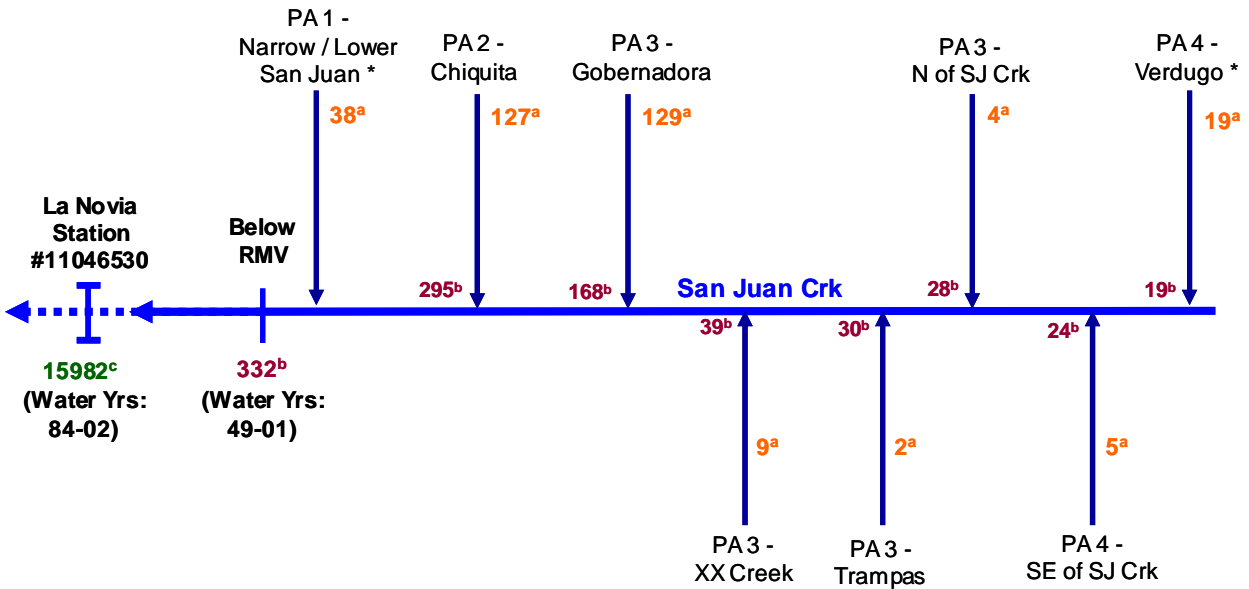
#### **8.3.2 San Mateo Creek Watershed**

In the San Mateo Creek watershed, the projected increase in mean annual runoff at the Lower Cristianitos gauges is about 480 acre-ft/yr or 24 percent for the B-4 alternative and less than one percent for the B-9 alternative. The increase for the B-4 alternative is caused by the projected excess flows from the Lower Gabino Sub-basin associated with Planning Area 7. Alternative B-9 does not call for development in the Cristianitos or Gabino sub-basins. Nonetheless, this increase does not take into account the fact that the Lower Cristianitos/San Mateo system is a “losing system” in which surface water runoff infiltrates into the stream bed and becomes part of the sub-surface flow system. The primary cause of this effect is the extensive groundwater pumping conducted at Camp Pendleton. This de-watering of the San Mateo system also has adversely impacted the arroyo toad habitat in the affected reaches. Additional runoff flows from

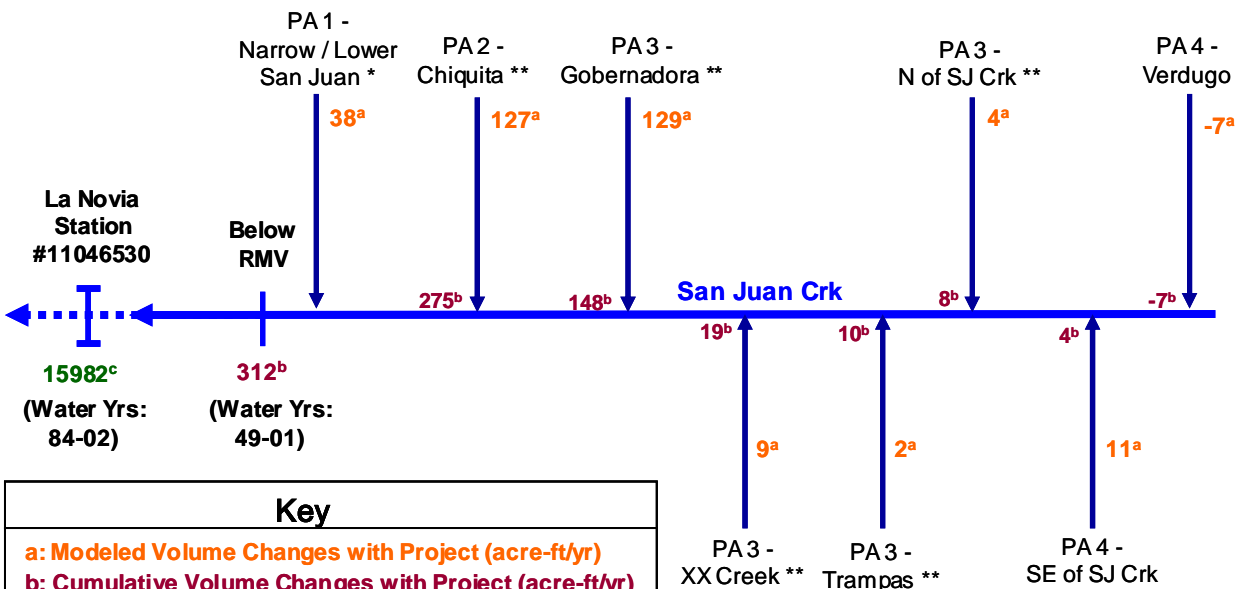
the proposed development, especially under the B-4 alternative, would augment in-stream flows and potentially improve arroyo toad habitat in this area. On this basis, the cumulative impact of the proposed development under the B-4 and B-9 alternatives on flows in San Mateo Creek is considered less than significant.

Projected changes in pollutant loads in Lower Cristianitos Creek at sampling station SW-8 vary depending on pollutant and alternative. For TSS, pollutant loads are projected to remain unchanged under the B-4 and B-9 alternatives. For nutrients, nitrate-nitrogen and phosphate loads are projected to increase by about 10 percent under the B-4 alternative and decrease slightly under the B-9 alternative. Nutrient concentrations are projected to essentially remain unchanged, and therefore the potential for stimulating algal growth is limited. Trace metal loads are projected to generally decrease except for dissolved copper and lead which are projected to increase by about 30 percent and 80 percent respectively for the B-4 alternative. Trace metal concentrations however are well below CTR criteria. On this basis, the cumulative effect of the proposed development under the B-4 and B-9 alternatives is considered less than significant.

### B4 Alternative



### B9 Alternative



Key
a: Modeled Volume Changes with Project (acre-ft/yr)
b: Cumulative Volume Changes with Project (acre-ft/yr)
c: Observed Average Stormwater Volumes (acre-ft/yr)
*Volumes estimated by scaling modeling results from other planning areas.
** Not modeled with proposed B9 Land-use. Used B4 modeling results.

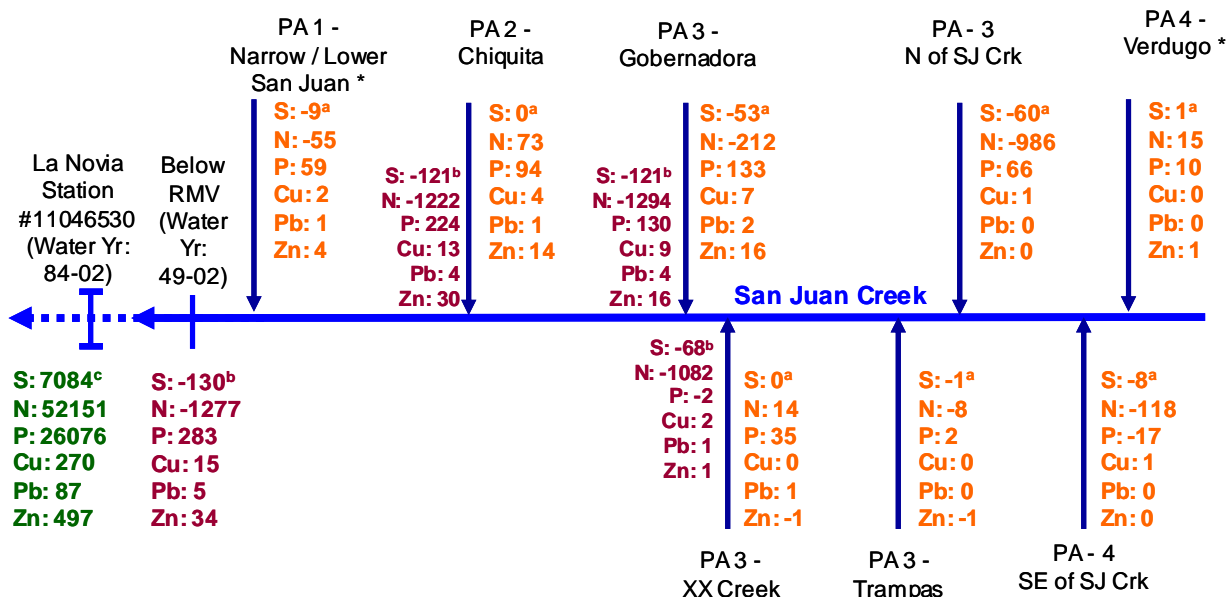
**Figure 8-1**  
**Cumulative Increases in Annual Storm Runoff Volumes in the San Juan Watershed**

March 2004

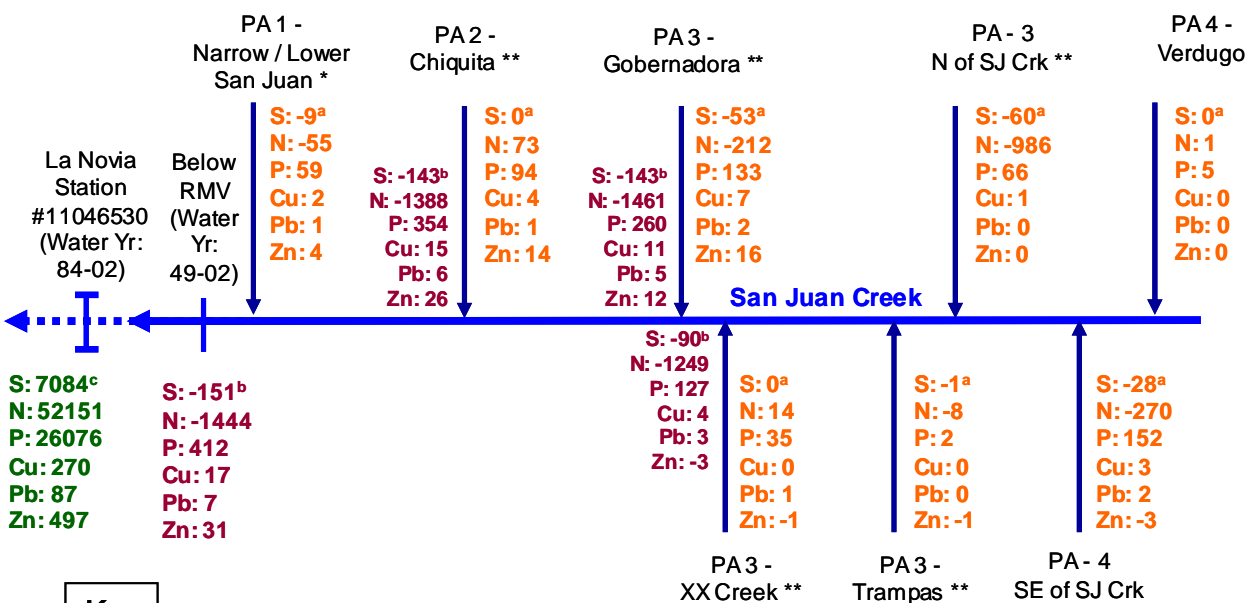
Water Quality Management Plan  
 Rancho Mission Viejo



### B4 Alternative



### B9 Alternative



#### Key

- a: Modeled Load Changes with Project (acre-ft/yr)
- b: Cumulative Load Changes with Project (acre-ft/yr)
- c: Observed Average Stormwater Loads (acre-ft/yr)

\*Loads estimated by scaling modeling results from other planning areas.

\*\* Not modeled with proposed B9 Land-use. Used B4 modeling results.

#### Modeled Constituents:

- S: TSS load (tons/yr)
- N: Nitrate-N load (lbs/yr)
- P: Phosphate-P load (lbs/yr)
- Cu: Dissolved Copper Load (lbs/yr)
- Pb: Dissolved Lead Load (lbs/yr)
- Zn: Dissolved Zinc Load (lbs/yr)

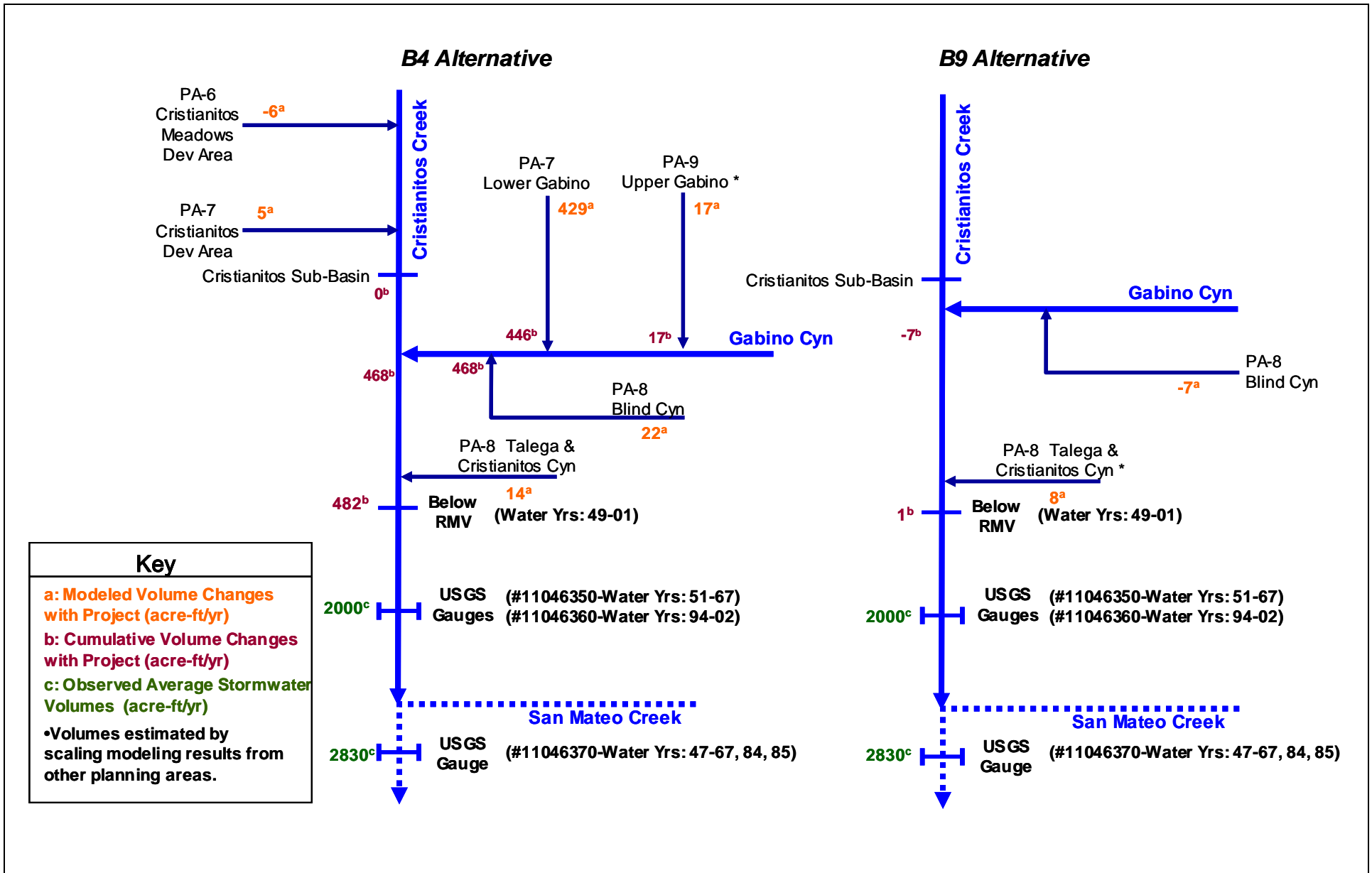
**Figure 8-2**  
**Cumulative Increases in Annual Pollutant Loads in the San Juan Watershed**

March 2004

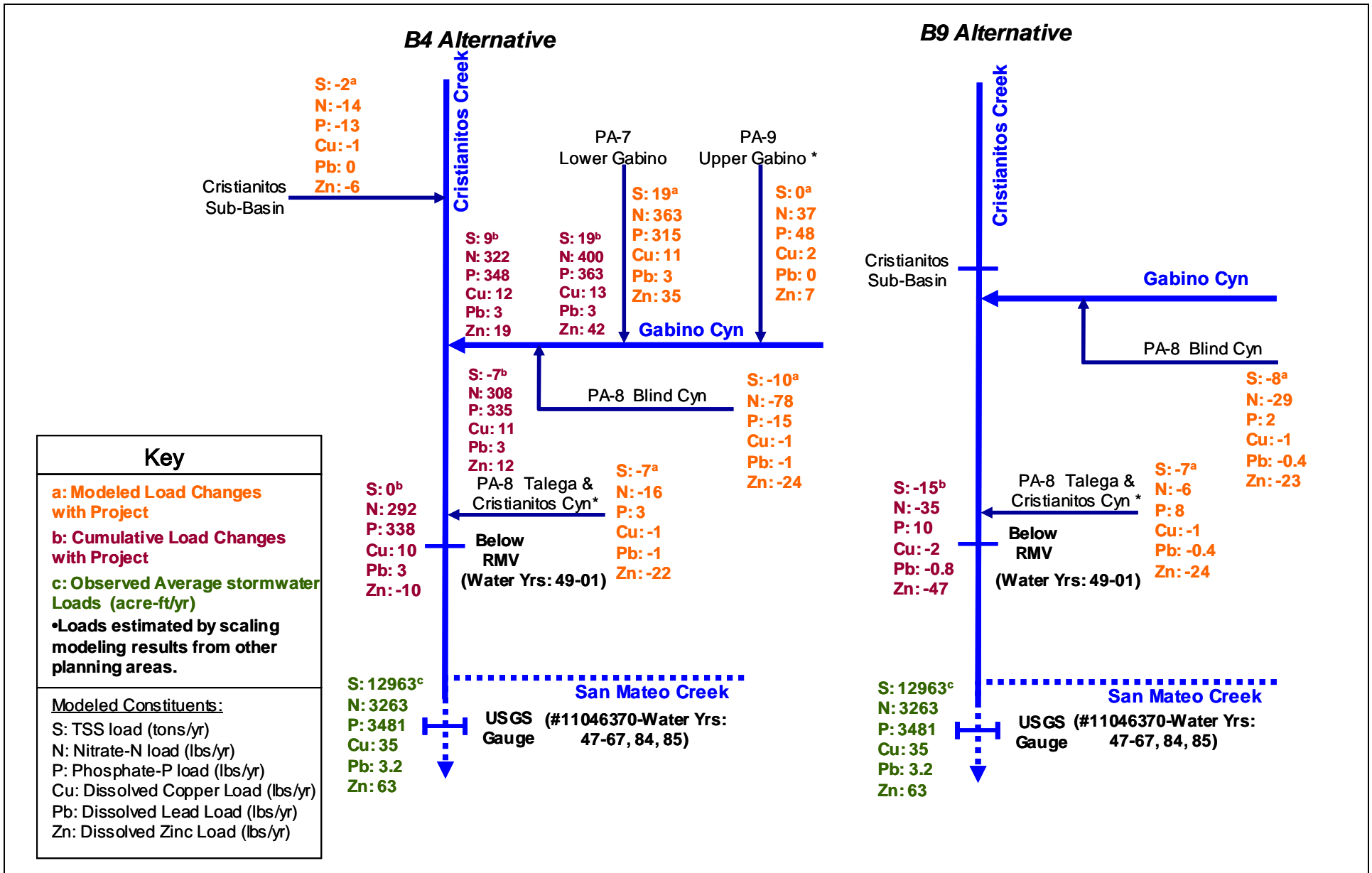
Water Quality Management Plan  
Rancho Mission Viejo







**Figure 8-3**  
**Cumulative Increases in Annual Storm Runoff Volumes in the San Mateo Watershed**



**Figure 8-4**  
**Cumulative Increases in Annual Pollutant Loads in the San Mateo Watershed**

## 9 GLOSSARY

Definitions that are denoted with an asterisk were obtained from the San Diego Regional Water Quality Control Board, Orange County NPDES Permit (SDRWQCB, February 2002).

**Aggradation:** The deposition and accumulation of sediment that was eroded and transported from the upstream watershed, resulting in an elevated streambed.

**Alluvium:** Silt, sand and gravel deposited by flowing water.

**Base Flow:** The normal day-to-day flow in the channel of a watershed from groundwater and spring contributions [Viessman et al., 1977].

**Clay:** Hydrous aluminum silicate minerals with platy structure, typically less than 1/256-mm in diameter.

**Colluvium:** Material deposited by gravity at the foot of a slope.

**Best Management Practices (BMPs)\*:** BMPs. are defined in 40 CFS 122.2 as schedules of activities, prohibitions of practices, maintenance procedures, and other management practices to prevent or reduce the pollution of waters of the United States. BMPs also include treatment requirements, operating procedures and practices to control plant site runoff, spillage or leaks, sludge or waste disposal, or drainage from raw material storage. In the case of municipal storm water permits, BMPs are typically used in place of numeric effluent limits.

**Bioaccumulate\*:** The progressive accumulation of contaminants in the tissues of organisms through any route including respiration, ingestion, or direct contact with contaminated water, sediment, pore water or dredged material to a higher concentration than in the surrounding environment. Bioaccumulation occurs with exposure and is independent of the trophic level.

**Clean Water Act Section 402(p)\*:** is the federal statute requiring municipal and industrial dischargers to obtain NPDES permits for their discharges of storm water.

**Clean Water Act Section 303(d) Water Body\*:** An impaired water in which water quality does not meet applicable water quality standards and/or is not expected to meet water quality standards, even after the application of technology based pollution controls required by the CWA. The discharge of urban runoff to these water bodies by the co-permittees is significant because these discharges can cause or contribute to violations of applicable water quality standards.

**Dry season:** April 1 to September 30.

**Dry weather flow:** In general, dry weather flows are flows in stream channels and storm drain systems that do not originate from precipitation events, such as flows generated from urban

activities (car washing, landscape irrigation, draining of swimming pools) and from natural base flow sources, primarily groundwater discharge.

**Erosion\***: When land is diminished or worn away due to wind, water, or glacial ice. Often the eroded debris (silt or sediment) becomes a pollutant via storm water runoff. Erosion occurs naturally but can be intensified by land clearing activities such as farming, development, road building, and timber harvesting.

**Geomorphology**: The study of forms and characteristics of the earth's surface and the physical and chemical processes that affect landforms. Weathering, erosion and transport are the fundamental geomorphic processes that break down mountains and supply sediment to stream channels.

**Hardpan**: A layer of hard subsoil or clay.

**Hydrology**: The scientific study of the properties, distribution, and effects of water on the earth's surface, in the soil and underlying rocks, and in the atmosphere.

**Hydrologic processes**: The extent to which precipitation is intercepted by vegetation, infiltrates into the ground, or results in overland flow, influencing the rate and magnitude of stream flows.

**Hydromodification**: The change in the natural watershed hydrologic processes and runoff characteristics (i.e., interception, infiltration, overland flow, interflow and groundwater flow) caused by urbanization or other land use changes that result in increased stream flows and sediment transport.

**Impervious surfaces**: A hard surface area that either prevents or retards the entry of water into the soil mantle. A hard surface area which causes water to run off the surface in greater quantities or at an increased rate of flow from the flow present under natural conditions prior to development. Common impervious surfaces include: roofs, roadways, walkways, driveways, parking lots, patios, concrete or asphalt paving, gravel roads, and packed earthen material.

**Incision**: The hydrologic processes of stream flow that exceeds the available sediment load and erodes streambeds, resulting in a deepening channel.

**Knickpoint**: The point of a stream bed where there is an abrupt change in slope, governed by regimen and by the structure and composition of the bed and bank materials of the river.

**Load**: the amount of pollutant, usually expressed in mass, such as pounds or tons, that is discharged to a receiving water body during a specified period of time. Examples of typical load units are lbs/day (pounds per day) and tons/year (tons per year).

**Loam**: Soil composed of a mixture of sand, clay, silt, and organic matter.

**Municipal Separate Storm Sewer System (MS4)\*** : A Municipal Separate Storm Sewer System is a conveyance or system of conveyances (including roads with drainage systems, municipal streets, catch basins, curbs, gutters, ditches, natural drainages features or channels, modified natural channels man-made channels, or storm drains): (i) Owned or operated by the State, city town, borough, county, parish, district, association, or other public body (created by or pursuant to State law) having jurisdiction over disposal of sewage, industrial wastes, storm water, or other waters, including special districts under State law such as a sewer district, flood control district or drainage district,, or similar entity, or an Indian tribe or an authorized Indian tribal organization, or designated and approved management agency under Section 208 of the CWA that discharges to waters of the United States; (ii) Designated or used for collecting or conveying storm water; (iii) Which is not a combined sewer; (iv) Which is not part of the Publicly Owned Treatment Works as defined at 40 CFR 1222.2.

Historic and current developments make use of natural drainage patterns and features as conveyances for urban runoff. Urban streams used in this manner are part of the municipalities MS4 regardless of whether they are natural, man-made, or partially modified features. In these cases, the urban stream is both an MS4 and a receiving water.

**National Pollution Discharge Elimination System (NPDES)\*** : These permits pertain to the discharge of waste to surface waters only. All State and Federal NPDES permits are also WDRs.

**Non Point Source (NPS)\*** : Non point sources refers to diffuse, widespread sources of pollution. These sources may be large or small, but are generally numerous throughout a watershed. Non Point sources include but are not limited to urban, agricultural, or industrial areas, roads, highways, construction sites, communities served by septic systems, recreational boating activities, timber harvesting mining, livestock grazing, as well as physical changes to stream channels, and habitat degradation. NPS pollution can occur year round and time rainfall snowmelt, irrigation, or any other source of water runs over land or through the ground, picks up pollutants from these numerous, diffuse sources and deposits them into rivers, lakes, and coastal waters or introduces them into ground water.

**Non-Storm Water\*** : Non-storm water consists of all discharges to and from a stormwater conveyance system that do not originate from precipitation events (i.e. all discharges from a conveyance system other than storm water).

**Nuisance Flows**: Persistent low flows in the dry season, originating from urban and agricultural activities.

**Pollutant\*** : A pollutant is broadly defined as any agent that may cause or contribute to the degradation of water quality such that a condition of pollution or contamination is created or aggravated.

**Sediment\***: Soil, sand, and minerals washed from land into water. Sediment resulting from anthropogenic sources (i.e. human induced land disturbance activities) is considered a pollutant. The NPDES permit regulates only the discharges of sediment from anthropogenic sources and does not regulate naturally occurring sources of sediment. Sediment can destroy fish-nesting areas, clog animal habitats, and cloud waters so that sunlight does not reach aquatic plants.

**Silt**: particles with diameters between 0.75 and 0.002-mm.

**Siltation**: The settling of soil and sedimentary particles in lakes, rivers and streams.

**Small storm events**: Storm flow runoff from about 1-inch of precipitation or less.

**Stormwater\***: Urban runoff and snowmelt runoff consisting only of discharges that originate from precipitation events. Stormwater is that portion of precipitation that flows across a surface to the storm drain system or receiving waters. Examples of this phenomenon include: the water that flows off a building's roof when it rains (runoff from an impervious surface); and the water that flows from a vegetated surface when rainfall is in excess of the rate at which it can infiltrate into the underlying soil (runoff from a pervious surface). When all factors are equal, runoff increases as the perviousness of a surface decreases. During precipitation events in urban areas, rain water picks up and transports pollutants through stormwater conveyance systems, and ultimately to water of the United States.

**Sub-basin**: The catchment area of a stream tributary or series of stream tributaries.

**Total Maximum Daily Load (TMDL)\***: The TMDL is the maximum amount of a pollutant that can be discharged into a water body from all sources (point and non-point) and still maintain water quality standards. Under Clean Water Act section 303(d), TMDLs must be developed for all water bodies that do not meet water quality standards after application of technology-based controls.

**Tributary**: A stream or river flowing into a larger body of water.

**Urbanization**: The transformation of land into residential, commercial, and industrial properties and associated infrastructure such as drainages, roads, and sewers.

**Urban Runoff\***: Urban runoff is defined as all flows in a storm water conveyance system and consists of the following components: (1) storm water (wet weather flows) and (2) non-storm water illicit discharges (dry weather flows).

**Water Quality Objective\***: Numerical or narrative limits on constituents or characteristics of water designated to protect designated beneficial uses of the water. [California Water Code Section 13050(h)]. California's water quality objectives are established by the State and Regional Water Boards in the Water Quality Control Plans. Water quality objectives are also called water quality criteria in the Clean Water Act.

**Water Quality Standards\*:** Are defined as the beneficial uses (e.g., swimming, fishing, municipal drinking water supply, etc.) of water and the water quality objectives necessary to protect those uses.

**Watershed\* :** The geographical area which drains to a specified point on a water course, usually a confluence of streams or rivers (also known as drainage area, catchment, or river basin).

**Water Year:** October 1 to September 30.

**Wet season:** October 1 to March 31.

## 10 REFERENCES

- Balance Hydrologics, 2001a. Appendix B, Baseline Water Quality Conditions, San Juan/San Mateo Creeks Special Area Management Plan (SAMP), Southern Orange County, California. September 2001.
- Balance Hydrologics, 2001b. Appendix C, Groundwater Sustaining Landscape-Scale Wetland Functions, San Juan and San Mateo Watersheds, Southern Orange County, California. September 2001.
- Brown and Caldwell, 1984. Fresno Nationwide Urban Runoff Program Project Final Report. Fresno Metropolitan Flood Control District. May 1984.
- CASQA 2003. California Stormwater BMP Handbook, New Development and Redevelopment. California Stormwater Quality Association. January 2003. [www.cabmphandbooks.com](http://www.cabmphandbooks.com).
- CIMIS, 2003. California Reference Evapotranspiration Map, California Irrigation Management Information System, <http://www.cimis.water.ca.gov/>.
- Grizzard, T., Randall, C., Weand, B., and K. Ellis, 1986. Effectiveness of Extended Detention Ponds. Published in *Urban Runoff Quality – Impact and Quality Enhancement Technology*, edited by Ben Urbonas and Larry Roesner, 1986.
- Irvine Ranch Water District, 2003. San Diego Creek Watershed Natural Treatment System Draft Master Plan. Prepared by GeoSyntec Consultants for the Irvine Ranch Water District. March 2003.
- King County, 1998. King County, Washington Surface Water Design Manual. King County Department of Natural Resources. September 1998.
- Leopold, L., 1997. *Waters, Rivers, and Creeks*. University Science Books, Sausalito, California.
- Los Angeles County, 2000. Los Angeles County 1994-2000 Integrated Receiving Water Impacts Report. Los Angeles County Department of Public Works, Alhambra, California. September 2000.
- Moore, Douglas, D. Ferguson, and E.J. Gonzalez, 2002. San Juan Creek Watershed Bacterial Study, Final Report. Study funded by California Regional Water Quality Control Board, San Diego Region, Agreement #9-182-190-0 issued to County of Orange Public Facilities and Resources Department. Study Conducted by Orange County Public Health Laboratory.
- NCCP/SAMP Working Group, 2003a. Draft Watershed and Sub-basin Planning Principles, San Juan/Western San Mateo Watersheds. Orange County, California. February 2003.



- NCCP/SAMP Working Group, 2003b. Draft NCCP/HCP Planning Guidelines. Southern Subregion. Orange County, California. April 2003.
- Orange County Public Facilities Resources Department (OCPFRD), 2003. Drainage Area Management Plan (DAMP). July 2003. A Cooperative Project of the County of Orange, the Cities of Orange County, and the Orange County Flood Control District.
- PCR Services Corporation and Dudek and Associates, 2002. Geomorphic and Hydrologic Needs of Aquatic and Riparian Endangered Species, Agency Review Draft. Prepared for Rancho Mission Viejo, August 2002.
- PCR Services Corporation; PWA, Ltd.; and Balance Hydrologics, Inc.; 2002. Baseline Geomorphic and Hydrologic Conditions, Final Version. Prepared for Rancho Mission Viejo, February 2002.
- Pitt, Robert, Shirley Clark, and Keith Parmer, 1994. Potential Groundwater Contamination From Intentional and Non-Intentional Stormwater Infiltration – 1993 Research Report. Risk Reduction Engineering Laboratory, US EPA. January 1994.
- Pitt, Robert, Alex Maestre, and Renee Morquecho, 2003. The National Stormwater Quality Database (NSQD, version 1.0). Presented at the National Conference on Urban Stormwater, Chicago Botanical Gardens and US EPA, Chicago, February 2003.
- Psomas, 2003. Water Quality Management Plan for Arroyo Trabuco Golf Course. Prepared for DMB/San Juan Golf Associates. June 2003.
- PWA, 2004. Alternatives Analysis: Hydrologic Comparison of Baseline and Alternative Land Use Conditions for San Juan and San Mateo Watersheds. Prepared for Rancho Mission Viejo. February 2004.
- Ribes, Sandra, B. Van Drooge, J. Dachs, O. Gustafsson, and J.O. Grimalt, Influence of Soot Carbon on the Soil-Air Partitioning of Polycyclic Aromatic Hydrocarbons, *Environ. Sci. Technol.* 37, 2675-2680.
- San Diego Regional Water Quality Control Board (SDRWQCB), 1994. Water Quality Control Plan, San Diego Basin (9).
- NCCP Science Advisors, 1997. Principles of Reserve Design, Species Conservation, and Adaptive Management for the Proposed Southern Orange County NCCP. The Southern Orange County NCCP Science Advisors, 1997.
- SDRWQCB, February 2002. Waste Discharge Requirements for Discharges of Urban Runoff from the Municipal Separate Storm Sewer Systems (MS4s) Draining the Watersheds of the County of Orange, the Incorporated Cities of Orange County, and the Orange County Flood

Control District within the San Diego Region (ORDER NO. R9-2002-0001, NPDES No. CAS0108740).

Strecker, E.W., M.M. Quigley, B.R. Urbonas, J.E. Jones, and J.K. Clary, 2001. "Determining Urban Storm Water BMP Effectiveness," ASCE Journal of Water Resources Planning and Management, Vol. 125 NO. 3, pp. 144-149, May/June 2001.

SWRCB, 2000. Nonpoint Source Program Strategy and Implementation Plan, 1998-2013 (PROSIP). State Water Resources Control Board and the California Coastal Commission, January 2000.

Tetra Tech, 2003. Santa Margarita Water District Plan of Works for Improvement Districts 4C, 4E, 5, and 6. November 2003.

US Army Corps of Engineers and the County of Orange, 2002. San Juan Creek Watershed Management Plan. September 2002.

U.S. Environmental Protection Agency (USEPA) California Toxics Rule (CTR), 40 C.F.R. §131.38.

USEPA, 2002a. National Management Measures to Control Nonpoint Source Pollution from Urban Areas— Draft. EPA 842-B-02-003. U.S Environmental Protection Agency Office of Wetlands, Oceans, and Watersheds Nonpoint Source Control Branch, July 2002.

USEPA, 2002b. Office of Water, National Recommended Water Quality Criteria 2002 , EPA 822-R-02-047 (November 2002). <http://www.epa.gov/waterscience/standards/wqcriteria.html>

USEPA, 2000. Guidance for Assessing Chemical Contaminant Data for Use in Fish Advisories Volume 1: Fish Sampling and Analysis, Third Edition. EPA 823-B-00-007. U.S. Environmental Protection Agency, Office of Science and Technology, Washington, DC.

Schroeder, 1995. Potential for Chemical Transport Beneath a Storm-Runoff Recharge (Retention) Basin for an Industrial Catchment in Fresno, California. U.S. Geological Survey Water Resources Investigations Report 93-4140, prepared in cooperation with the Fresno Metropolitan Flood Control District. 1995.

Sharma, Mukesh; Edward A. McBean; and Jiri Marsalek, 1997. Source Characterization of Polycyclic Aromatic Hydrocarbons in Street and Creek Sediments. Water Quality Research Journal of Canada, 32(1): 23-25 (1997).

Ventura County Flood Control Department (VCFCD) July 2001. *Ventura Countywide Stormwater Monitoring Program: 2000/01 Monitoring Status Report*.

Ventura County Flood Control Department (VCFCD) November 1999. *Ventura Countywide Stormwater Monitoring Program: Annual Report for Permit Year 5*.

Ventura County Flood Control Department (VCFCD) November 1998. *Ventura Countywide Stormwater Monitoring Program: Annual Report for Permit Year 4.*

Ventura County Flood Control Department (VCFCD) November 1, 1997. *Ventura Countywide Stormwater Monitoring Program: Annual Report for Permit Year 3.*

Viessman, W., J.W. Knapp, G.L. Lewis, T.E. Harbaugh, 1977. *Introduction to Hydrology*, Harper & Row, New York.

WEF, 1998. Water Environment Federation Manual of Practice No. 23/ASCE Manual of Practice No. 87, Urban Runoff Quality Management, 1998.

Wetland Research Associates, Inc., 2002. Draft Technical Memorandum, Aquatic Ecological Screening and Potential Chemicals of Concern for Southwestern Arroyo Toad, Southern Steelhead, and Tidewater Goby. Prepared for Ranch Mission Viejo. November 2002.

Winer, R. 2000. National Pollutant Removal Performance Database for Stormwater Treatment Practices: 2nd Edition. Center for Watershed Protection. Ellicott City, MD.

**Appendix A:**  
**Continuous Hydrologic Simulation and Water Balance Analyses**

## Table of Contents

A-1	Introduction.....	1
A-1.1	Problem Statement.....	1
A-1.2	Hydrologic Characteristics and the Relation to Development Plans.....	2
A-1.3	Hydromodification Assessment Approach.....	4
A-2	Swmm Input Requirments and General Parameterization Approach.....	5
A-2.1	Data Requirements and Data Sources.....	5
A-2.2	Subcatchment Delineation and Disaggregation.....	6
A-2.3	Subcatchment Properties.....	7
A-2.3.1	Geometry.....	7
A-2.3.2	Slope.....	8
A-2.3.3	Stream Network.....	8
A-2.4	Rainfall.....	8
A-2.4.1	Available Rainfall Records and Gauge Selection.....	8
A-2.4.2	Construction of Continuous Rainfall Records.....	9
A-2.4.3	Determination of Dry and Wet Cycles.....	10
A-2.4.4	Adjustment for Orographic Effects.....	11
A-2.5	Soil Properties and Infiltration Parameters.....	12
A-2.5.1	Soil Properties.....	12
A-2.5.2	Imperviousness.....	13
A-2.6	Evapotranspiration.....	14
A-2.7	Irrigation.....	17
A-2.8	Model Calibration.....	23
A-3	Hydrologic Simulation Parameters and SWMM Calibration Results of the Modeled Sub-Basins.....	25
A-3.1	SWMM Model of the Cañada Chiquita Sub-Basin.....	25
A-3.1.1	Cañada Chiquita Model - Subcatchment Delineation.....	25
A-3.1.2	Cañada Chiquita Model - Land-Use.....	28
A-3.1.3	Cañada Chiquita Model - Soils.....	29
A-3.1.4	Cañada Chiquita Model - Calibration.....	29
A-3.2	SWMM Model of the Cañada Gobernadora Sub-Basin.....	30
A-3.2.1	Cañada Gobernadora Model - Subcatchment Delineation.....	30
A-3.2.2	Cañada Gobernadora Model - Land-Use.....	33
A-3.2.3	Cañada Gobernadora Model - Subcatchment Soils.....	34
A-3.2.4	Cañada Gobernadora Model - Calibration.....	34
A-3.3	SWMM Model of the Central San Juan Sub-Basin.....	35
A-3.3.1	Central San Juan Model - Subcatchment Delineation.....	35
A-3.3.2	Central San Juan Sub-Basin Model - Land-Use.....	40
A-3.3.3	Central San Juan Sub-Basin Model - Subcatchment Soils.....	41
A-3.3.4	Central San Juan Sub-Basin Model – Calibration.....	41
A-3.4	Cristianitos Sub-Basin – SWMM Simulation Parameters.....	42
A-3.4.1	Cristianitos Sub-Basin Model - Subcatchment Delineation.....	42
A-3.4.2	Cristianitos Sub-Basin Model - Land-Use.....	45
A-3.4.3	Cristianitos Sub-Basin Model - Subcatchment Soils.....	46

A-3.4.4	Cristianitos Sub-Basin Model – Calibration .....	46
A-3.5	Gabino Sub-Basin Model.....	46
A-3.5.1	Gabino Sub-Basin Model - Subcatchment Delineation .....	46
A-3.5.2	Gabino Sub-Basin Model - Land-Use.....	50
A-3.5.3	Gabino Sub-Basin Model - Subcatchment Soils.....	51
A-3.5.4	Gabino Sub-Basin Model – Calibration.....	51
A-3.6	Blind Canyon and Talega Canyons Model .....	51
A-3.6.1	Blind Canyon and Talega Model - Subcatchment Delineation .....	51
A-3.6.2	Blind Canyon and Talega Model - Land-Use .....	53
A-3.6.3	Blind Canyon and Talega Model - Subcatchment Soils .....	54
A-3.6.4	Blind Canyon and Talega Model – Calibration .....	54
A-3.7	Verdugo Canyon Model.....	55
A-3.7.1	Verdugo Canyon - Subcatchment Delineation .....	55
A-3.7.2	Verdugo Sub-Basin Model - Land-Use .....	56
A-3.7.3	Verdugo Sub-Basin Model - Subcatchment Soils .....	56
A-3.7.4	Verdugo Sub-Basin Model – Calibration .....	57
A-4	Monthly Water Balance .....	57
A-4.1	Water Balance Calculation Procedure .....	57
A-4.2	BMP Sizing and Inclusion in the Monthly Water Balance.....	58
A-4.2.1	Detention Basin – Sizing and Inclusion in Water Balance .....	58
A-4.2.2	Flow Duration Basin – Sizing and Inclusion in Water Balance .....	58
A-4.2.3	Infiltration Basin – Sizing and Inclusion in Water Balance .....	59
A-4.2.4	Bioinfiltration Swale – Sizing and Inclusion in Water Balance Sizing .....	60
A-4.2.5	Storage of Non-Potable Water for Golf Course Irrigation.....	60
A-5	References.....	61

## List of Tables

Table A-1: Data Summary of Selected Hourly Rain Gauges .....	9
Table A-2: Comparison of Summary Statistics for Original and Constructed Rainfall Records at the Trabuco Gauge for WY 1949-2001 .....	10
Table A-3: Estimated Average Annual Rainfall by Elevation.....	11
Table A-4: Soil Properties of Soil Texture Classes .....	13
Table A-5: Percent Impervious Coverage Values Used the SWMM Models .....	13
Table A-6: Compilation of Monthly ET Rates for Various Vegetation Type .....	15
Table A-7: Vegetation Group $E_t$ , Scaling Factor and Annual ET .....	17
Table A-8: Average Annual Water Usage for Landscape Irrigation .....	17
Table A-9: Average Monthly Water Usage for Landscape Irrigation .....	20
Table A-10: Irrigated Fraction of Development Areas and Annual Irrigation Depths.....	23
Table A-11: Modeled Watershed Areas .....	25
Table A-12: Cañada Chiquita Model – Pre-Development Subcatchment Parameters .....	26
Table A-13: Cañada Chiquita Model – Post-Development Subcatchment Parameters.....	27
Table A-14: Cañada Chiquita Model – Pre- and Post- Development Land Use .....	29
Table A-15: Cañada Chiquita Model – Calibration Data and Calibration Results.....	30
Table A-16: Cañada Gobernadora – Pre-Development Subcatchment Parameters.....	31
Table A-17: Cañada Gobernadora – Post-Development Subcatchment Parameters .....	32
Table A-18: Cañada Gobernadora – Pre- and Post- Development Land Use in the RMV Project Area (excludes Wagonwheel and Coto de Caza).....	33
Table A-19: Cañada Gobernadora Model – Calibration Data and Calibration Results.....	34
Table A-20: Central San Juan Sub-Basin Model – Pre-Development Subcatchment Parameters	36
Table A-21: Central San Juan Sub-Basin Model – Post-Development Subcatchment Parameters .....	38
Table A-22: Central San Juan Sub-Basin Model – Pre- and Post- Development Land Use .....	41
Table A-23: Cristianitos Model – Pre-Development Subcatchment Parameters.....	42
Table A-24: Cristianitos Model – Post-Development Subcatchment Parameters .....	44
Table A-25: Cristianitos Sub-Basin Model – Pre- and Post- Development Land Use .....	45
Table A-26: Cristianitos Sub-Basin Model - Calibration Data and Calibration Results .....	46
Table A-27: Gabino Sub-Basin Model – Pre-Development Subcatchment Parameters.....	47
Table A-28: Gabino Sub-Basin Model – Post-Development Subcatchment Parameters .....	49
Table A-29: Gabino Sub-Basin Model – Pre- and Post- Development Land Use.....	50
Table A-30: Gabino Sub-Basin Model - Calibration Data and Calibration Results.....	51
Table A-31: Blind Canyon and Talega Model – Pre-Development Subcatchment Parameters ...	52
Table A-32: Blind Canyon and Talega Model – Post-Development Subcatchment Parameters .	53
Table A-33: Blind Canyon and Talega Model – Pre- and Post- Development Land Use .....	54
Table A-34: Verdugo Sub-Basin Model – Pre-Development Subcatchment Parameters .....	55
Table A-35: Verdugo Sub-Basin Model – Post-Development Subcatchment Parameters.....	55
Table A-36: Verdugo Sub-Basin Model – Pre- and Post- Development Land Use .....	56

## **List of Figures**

*(All Figures follow the Appendix)*

- Figure A-1: Hydrologic Cycle
- Figure A-2: Conceptualization of Sub-basin Disaggregation
- Figure A-3: Location of Selected Rain Gauges in Orange County
- Figure A-4: Elevation Profiles Between Selected Rain Gauges
- Figure A-5: Rainfall Correlations for Monthly, Annual, and Storm Event Accumulations of Hourly Precipitation Data
- Figure A-6: Rainfall Wet and Dry Cycles
- Figure A-7: Planning Area Location Map
- Figure A-8: Cañada Chiquita Sub-basin Pre- and Post-Development Land Use
- Figure A-9: Cañada Chiquita Sub-basin Soil Texture Distribution
- Figure A-10: Cañada Gobernadora Sub-basin Pre- and Post-Development Land Use
- Figure A-11: Cañada Gobernadora Sub-basin Soil Texture Distribution
- Figure A-12: Comparison of Measured and Simulated Hydrographs for Upper Gobernadora
- Figure A-13: Central San Juan and Trampas Sub-basin Pre- and Post-Development Land Use
- Figure A-14: Central San Juan and Trampas Sub-basin Soil Texture Distribution
- Figure A-15: Cristianitos Sub-basin Pre- and Post-Development Land Use
- Figure A-16: Cristianitos Sub-basin Soil Texture Distribution
- Figure A-17: Gabino Sub-basin Pre- and Post-Development Land Use
- Figure A-18: Gabino Sub-basin Soil Texture Distribution
- Figure A-19: Blind and Talega Sub-Basins Pre- and Post-Development Land Use
- Figure A-20: Blind and Talega Sub-Basins Soil Texture Distribution
- Figure A-21: Verdugo Sub-Basins Pre- and Post-Development Land Use
- Figure A-22: Verdugo Sub-Basins Soil Texture Distribution



## **A-1 INTRODUCTION**

Proposed development in Rancho Mission Viejo (RMV) can potentially cause changes in the hydrologic characteristics of the sub-basins. This appendix presents a detailed description of hydrologic analyses performed to quantify potential changes in the hydrologic regime from urban development, and to evaluate the effectiveness of Best Management Practices (BMPs) to mitigate potential impacts.

This appendix is divided into three sections:

1. Problem Statement and General Assessment Approach
2. Detailed Model Description and Parameterization Procedures
3. Model Description for Individual Watersheds

### **A-1.1 Problem Statement**

Changes to the hydrologic regime from urban development are referred to as hydromodification. Hydromodification includes two elements:

1. Changes in the low flow hydrology, including base flows and durations of elevated flows following storm events. These changes result from changes in the runoff pattern to existing infiltration area, irrigation of landscape areas and golf course watering, pavement and car washing, as well as the increase in runoff durations from storm events.

The impact of these flows is primarily on the wetting of riparian areas and can result in a type change in vegetation. Other impacts can include water quality if such low flows are higher in nutrients or other materials that can be leached from soils.

2. Changes in runoff characteristics from small and moderate size storm events, including peak values and duration of in-stream flows where the resulting impacts include changes in sediment transport, stream erosion and/or sedimentation, and ultimately habitat. Hydromodification effects on stream stability are most significant for a range of flows from the lowest flow that initiates bedload sediment transport to the bankfull flow. The return period of such “geomorphically significant flows” varies but is generally considered some fraction (say 1/3 to 1/2) of the bankfull flow up to the bankfull flow. The return period of the bankfull flow will vary depending on the stream but is generally considered to be around the 1.5 to 2 year event, but could be as high as a 10-year event. Hydromodification is a cumulative effect in that the more frequent geomorphically significant flows over time contribute far more energy for sediment transport compared to the less frequent large events, even though the larger events clearly transport more sediment on an event basis.

The goals for hydromodification control are to insure that project-induced changes to the hydrologic regime do not adversely affect the duration of those flows that are primarily responsible for hydromodification.

## **A-1.2 Hydrologic Characteristics and the Relation to Development Plans**

A detailed description of hydrologic characteristics in the study area is presented in the Baseline Geomorphic and Hydrologic Conditions report (RMV, February 2002). These descriptions are summarized below in the context of hydrologic abstractions shown Figure A-1. Planning principles of the proposed development are based to a large extent on the recognition and understanding of hydrologic responses of different terrains at the watershed and sub-basin scale (RMV, July 2002). Included below are summaries of pertinent planning principles associated with the hydrologic abstractions, and a description of how the principles are addressed in the hydrologic analysis.

- **Precipitation.** In the absence of development, precipitation is the main source of water to the watershed. Urban development and associated importation of domestic water supplies will increase water inputs to the basins. Precipitation occurs primarily as rain from general winter storms during the wet season from October through March. Little rainfall occurs during the dry season from April through September. The average annual rainfall in the study area is about 15 inches.

Cyclical periods of above average and below average rainfall are common. The baseline conditions report (RMV, February 2002) states that a protracted dry cycle from 1945 to 1977 lowered groundwater levels and reduced the extent of riparian corridors in the study area. Hamilton (2000) found the magnitude of hydrologic effects from long-term dry and wet cycles were similar or greater to the anticipated effects of proposed development in Muddy Canyon (western Orange County). A planning tenant is the consideration of longer-term wet/dry cycles and how such cycles influence hydrologic conditions (Planning Principle 5, RMV, July 2002). Therefore, hydrologic conditions during dry and wet periods were considered in this assessment. In addition, the hydrologic analyses take into account effects from importation of water for landscape irrigation.

- **Storm Runoff.** The amount of surface runoff from precipitation depends on the rainfall intensity, surface coverage, slope, the soil properties, and the antecedent soil moisture. Impervious areas associated with urban development can dramatically increase surface runoff if hydrologic responses are not considered and/or hydrologic source controls are inadequate.

Applicable planning principles are: recognize the hydrologic responses of different terrains; and emulate, to the extent feasible, existing runoff patterns by locating proposed developed in areas characterized by high runoff rates/ low infiltration (Planning Principle 1 & 2, RMV, July 2002). A major portion of the hydrologic assessment was devoted to the comparison of pre- and post-development runoff patterns and the evaluation of proposed hydrologic source control measures.

- **Infiltration.** The vast majority of the precipitation will infiltrate into the subsurface. The amount and rate of infiltration depends on the soil type, vegetation coverage, slope, and soil moisture. Infiltration diminishes over the duration of storm events and in relation to the time

from preceding storms. Urban development can potentially cause hydromodification by altering runoff patterns to existing infiltration areas.

Applicable planning principles are protect and mimic existing infiltration patterns to the maximum extent feasible by limiting new impervious development in major side canyons and swales; provide setbacks from the main stem channel to retain high infiltration capacity of the valley floor; where feasible, route drainage from development areas detention/infiltration in sandy terrains; and where possible, restore native grasslands to reduce erosion and increase stormwater infiltration (Planning Principle 1, 2, & 7, RMV, July 2002). The hydrologic assessment was based on modeling of rainfall/runoff/infiltration processes over a long-term continuous rainfall record. This permits a direct accounting of infiltration volumes and the potential impacts of development on infiltration, as well as, the assessment of infiltration BMPs for mitigating potential impacts.

- **Groundwater Discharge and Base Flows.** Groundwater discharge supports dry season streamflow and wet season base flow between storms. The duration and aerial extent of groundwater flows varies among the RMV sub-basins, influenced by the geologic and hydrologic characteristics of the sub-basins. Sandy sub-basins (Chiquita and Gobernadora) support perennial or near perennial flows. Other sub-basins only sustain ephemeral streamflow following the rainy season because the geologic conditions do not enable the movement of substantial volumes of water to the creek.

Applicable planning principles are: address potential effects of future land use changes on dry season streamflow; protect existing groundwater recharge areas supporting slope wetlands and riparian zones; and maximize groundwater recharge of alluvial aquifers to the extent consistent with aquifer capacity and habitat management goals (Planning Principle 3 & 8, RMV, July 2002). The modeling approach used to assess hydrologic conditions includes groundwater routines to model groundwater storage and discharge. This allows the continuous simulation of dry and wet weather streamflow and permits a quantitative evaluation of development impacts on groundwater discharge and dry weather streamflow, as well as assessment of infiltration BMPs.

- **Evapotranspiration.** Evapotranspiration (ET) is the sum of the amount of water transpired by vegetation and the amount of water evaporated from the soil or intercepted by vegetation. Much of the precipitation in the study is lost to ET consumption (Young and Blaney, 1942). ET rates strongly depend on local conditions and are influenced by a number of factors including: vegetation type, coverage and distribution, temperature, humidity, wind speed, soil type, soil moisture, and precipitation. Changes in land-use (e.g. conversion of rangeland or agricultural land to urban development, restoration of grazing areas) can potentially alter ET patterns through changes in the type and distribution of vegetation coverage, as well as the water availability to native and landscape vegetation.

Applicable planning principles are: address potential effects of future land use changes on hydrology, and where feasible restore native upland and riparian habitat to reduce erosion

and reduce pollutant loadings (Planning Principle 1, 3 & 9, RMV, July 2002). ET losses are quantified and differentiated by vegetation groups as part of this hydrologic assessment.

### **A-1.3 Hydromodification Assessment Approach**

Hydromodification effects were quantified with the USEPA Storm Water Management Model (SWMM). SWMM is a public domain model that is widely used for modeling hydrologic and hydraulic processes affecting runoff from urban and natural drainages. The model can simulate all aspects of the urban hydrologic and quality cycles, including rainfall, surface and subsurface runoff, flow routing through the drainage network, storage and treatment.

Two main measures were used to gauge hydromodification in this hydrologic assessment:

1. A Monthly Water Balance
2. Flow Duration Curves

**Water Balance.** A water balance is a direct accounting of the hydrologic abstractions discussed above. Comparison of the water balance for pre- and post-development conditions provides an indication of potential development impacts on the hydrologic regime.

The SWMM model is well suited for quantifying water balances because it is capable of simulating all aspects of the hydrologic cycle. The water balance was calculated on a monthly basis because hydrologic processes are seasonal. In addition, water balances were determined for dry and wet periods to evaluate natural variation in the hydrologic regime in comparison with potential impacts from development.

**Flow Duration Curves.** A flow duration curve relates streamflow and the total duration of time in which the flow rate is exceeded. The flow duration curves are a measure of the range of geomorphically significant flows that could potentially impact beneficial uses. Matching of the pre- and post- development flow duration curves was used as a criterion for sizing of hydrologic sources control BMPs.

## **A-2 SWMM INPUT REQUIRMENTS AND GENERAL PARAMETERIZATION APPROACH**

### **A-2.1 Data Requirements and Data Sources**

Data requirements for continuous hydrologic simulation using SWMM are extensive. Data requirements include:

- Catchment characteristics and geometry – area, slope, imperviousness, roughness, width (a shape factor), depression and interception storage, overland flow roughness coefficients
- Infiltration parameters – soil distribution, soil conductivity, suction pressure, moisture deficit
- Subsurface characteristics – average conductivity, depth, moisture retention properties, relative hydraulic conductivity properties
- Channel characteristics – length, slope, shape, roughness
- Precipitation records – hourly precipitation data for the period of continuous simulation; irrigation estimates (volume and timing) for post-development conditions
- Evapotranspiration (ET) properties – vegetation type and distribution, average monthly evapotranspiration rates for representative vegetation types
- Measured discharge hydrographs or point estimates for model calibration
- Land-use information for existing conditions and for proposed development
- BMP identification and sizing estimates

#### **Sources of data used to construct the SWMM input included the following:**

- Topographic maps (2 and 5 foot contour intervals) were obtained from Edaw Inc in digital AutoCAD format.
- Existing vegetative and land-use coverage (WES data) was provided by PWA Consultants in digital Geographical Information System (GIS) format.
- Proposed land-use coverage (B4 and B9 Plans) was obtained from Edaw Inc in digital GIS format. These are planning level concept plans that do not include detailed development types. Edaw Inc also provided GIS maps delineating proposed areas for coastal sage restoration.
- Detailed development concepts and grading plans in the Chiquita Canyon watershed were provided by Edaw Inc. The development plans were provided in PDF format, which was then traced into GIS format. The grading plan was provided in AutoCAD format.
- Soils data were obtained from the US Dept of Agriculture Soil Survey of Orange County and Western Part of Riverside County, California (1978). In addition, GIS files of the

perched hardpans areas mapped by Morton (1974) were obtained from Balance Hydrologics. Detailed descriptions of local geomorphic conditions are found in the Base Conditions Report (RMV, February 2003) and in Technical Appendix A (PWA, May 2002) and Appendix C (Balance, September 2001).

- Precipitation data were obtained from the National Climatic Data Center.
- Evaporation data and information was obtained from a variety of sources discussed in Section A-2.6.
- Data used to calibrate the SWMM models include: flow monitoring data collected by Wildermuth Environmental (July, 2003); base flow measurements collected by Balance Hydrologics (September 2001); and peak flow estimates determined from high water marks (Balance, 2003b)

The following describes the procedures and general approach used to compile and parameterize data inputs for SWMM.

### **A-2.2 Subcatchment Delineation and Disaggregation**

To account for variability in spatial properties the study watersheds were subdivided into subcatchments that are idealized in SWMM as having spatially lumped properties. The number of required subcatchments depends on the amount of hydrologic/hydraulic detail that must be modeled. A high-degree of basin disaggregation is generally not necessary for continuous simulations because reasonable agreement is possible between hydrographs produced by coarse and fine catchment discretization (James, 2000). Therefore, it was desirable to disaggregate the study watershed by as few subcatchments as possible, consistent with the needs for hydraulic detail within the catchment.

A conceptualization of the watershed desaggregation is shown in Figure A-2. The criteria used to disaggregate the study area watersheds are described below:

- Stream networks. The total watershed was divided into a reasonable number subcatchments based on the stream network based on topography. Each subcatchment typically includes the drainage area from one or a few major side canyons of the main stem channel. Smaller subcatchments were delineated in the development areas or in areas with anticipated changes (e.g. coastal scrub restoration areas); slightly larger subcatchments were typically delineated in areas with no anticipated changes.
- Topography. As shown in Figure A-2, each subcatchment was subdivided into a valley subcatchment and a ridge subcatchment based on topography. The valley subcatchments typically have milder average slopes, permeable alluvial deposits, and more riparian habitat. Each of these factors affects the volume of the surface runoff, infiltration, ET, and groundwater recharge as computed by SWMM.

Routing between the ridge and valley subcatchments in SWMM is depicted in Figure A-2. Surface runoff from the ridge subcatchment was routed to the valley subcatchment, and surface runoff from the valley subcatchment was routed to the stream channel. Both ridge and valley subcatchments were modeled with a groundwater compartment. The groundwater compartment receives recharge from water that infiltrates and percolates through the unsaturated zone. Discharge from the groundwater compartment is the source of dry weather base flows, and is routed to the stream channel in the valley subcatchment. SWMM tracks on a continuous basis, the height of the groundwater table, soil moisture in the unsaturated zone, ET losses from the subsurface, and groundwater discharge to the valley stream.

- Development areas were modeled in two ways:
  - a. The development areas were disaggregated into separate catchments to facilitate the assessment of development impacts and the sizing and effectiveness of BMPs. Six development watershed types were defined: residential, estate, transportation, commercial, parks, golf course. Runoff from the development subcatchments were routed in accordance to their location within ridge or valley areas, and/or in accordance to the type of BMP treatment applied to the development. This approach was used to model the Chiquita Watershed and in all watershed where specific BMPs are explicitly modeled with SWMM (e.g. detention basins, infiltration basins).
  - b. In some watersheds BMPs were not modeled with SWMM but are addressed through separate quantitative or qualitative analyses. In these watersheds, the development areas were not disaggregated but were retained within the valley/ridge subcatchments. Impacts of the development area are captured in SWMM through the appropriate representation of the imperviousness area and vegetative coverage.

### **A-2.3 Subcatchment Properties**

#### **A-2.3.1 Geometry**

Subcatchments are idealized in SWMM as rectangular in shape (see Figure A-2) with dimensions defined by area, length, and width (area = length times width). GIS tools were used to determine the subcatchment areas. The subcatchment lengths were estimated as the maximum overland flow length based on topographic information. The basin width was calculated from the area and length (width = area divided by length).

### **A-2.3.2 Slope**

The GIS contour maps were used to construct Digital Elevation Models (DEM) of the study watersheds. A DEM is a collection of spatially averaged elevations at discrete nodes throughout the watershed. The average slope of the modeled subcatchments was calculated from the DEM using available GIS tools.

### **A-2.3.3 Stream Network**

Channel networks in the study watersheds were modeled as a main stem channel fed by tributary channels in the valley subcatchments (see Figure A-2). The channel network is input into the SWMM as a sequence of channel segments, each with separate dimensions, geometry, and slope. The channel segments were modeled as trapezoidal in shape with varying width and surface roughness. The length and slope of the channel segments was determined from the DEM of the study watersheds.

## **A-2.4 Rainfall**

The hydrologic assessment is based on modeling rainfall-runoff processes over a long-term and continuous period. Hydromodification studies with SWMM require, at a minimum, the use of hourly rainfall records to quantify storm intensities. Daily precipitation data do not accurately represent storm intensity because storm durations are typically less than 24 hours. Periods of greatest rainfall intensity are generally short in duration, often less than one hour.

### **A-2.4.1 Available Rainfall Records and Gauge Selection**

The location of hourly gauging stations in Orange County is shown in Figure A-3 on the County isohyetal map for comparative purposes. Daily rainfall gauges at El Toro and Tustin are also shown, as these gauges have long-term records and are often used in local hydrological studies. Station information of the hourly gauges is summarized in Table A-1 for gauges shown in Figure A-3, as well as additional gauges in neighboring counties.

The most suitable hourly gaging stations on the basis of general proximity to the study area and quantity and quality of data are the Santiago Dam and Trabuco gauges north of the project area, and the Laguna Beach gauge to the west (see Table A-1). Orographic influences were also considered in the gauge selection through the inspection of elevation profiles along two transects shown in Figure A-3. The transect between the Laguna and Santiago Dam gauges shows the Santiago Dam gauge is located behind a ridge that could reduce the orographic influence on precipitation. Similar effects are less evident between the Laguna and Trabuco gauges.

The hourly precipitation data from the Trabuco gauge is the most representative of the study area because it is the closest of the available hourly gauges, it has second least amount of missing records, and it best represents orographic conditions in the study area. Precipitation data from the Trabuco gauge were used in the SWMM modeling



**Table A-1: Data Summary of Selected Hourly Rain Gauges**

Rain Gauge	Elevation (ft)	Approximate Distance to Study Area (miles)	Available Period of Record	Approximate Number of Missing Days Between 1948-2001
Oceanside PP	30	30	'53 – '01	
Laguna Beach No. 2	210	10	'49 – '01	1628
Brea Dam	255	28	'49 – '81, '83 – '01	
Fullerton Dam	340	27	'49 – '81, '83 – '01	
Fallbrook	660	25	'49 – '93	
San Juan Guard Station	730	6	'49 – '71, '79 – '01	6110
Santiago Dam	855	16	'48-'80, '83-'01	2170
Trabuco Canyon	970	5	'49 – '01	1760
Silverado Ranger Station	1095	12	'49 – '81, '83 – '01	3048
Elsinore	1285	18	'67 - '01	
Santiago Peak	5638	10	'72 – '01	

#### A-2.4.2 Construction of Continuous Rainfall Records

The hourly rainfall records from the Trabuco, Santiago Dam, and Laguna Beach Stations each contain missing and deleted records (Table A-1). Many of the data gaps are continuous over months, and in some cases years, such that large blocks of missing records occur at some stations. These missing records can potentially lead to inaccurate representation of streamflow hydrographs and water balance results. A procedure to construct a continuous rainfall record was developed.

Monthly and annual rainfall totals at the Trabuco, Santiago Dam, and Laguna Beach stations were found to correlate reasonably well among all three stations (Figure A-5). The monthly data were screened such that only months with no (or minor amounts of) missing records at both stations are included in the correlation. The annual data were screened to exclude records with a substantial amount of missing records. To check that the monthly accumulations are representative of storm events, the storm events at the Trabuco and Santiago stations were paired and plotted (Figure A-5a). A correlation equation for the storm events was found to be similar to that for the monthly and annual accumulations, suggesting that correlation equations developed with the monthly data can be reasonably applied to the hourly data.

The linear regression equations for the monthly accumulations were used to transpose hourly precipitation data between the three stations. A priority was assigned as to which stations would be used if corresponding data were available at more than one station. The following relations were used to estimate missing data at Trabuco gauge:

1. Use data from Santiago if available:  $V_{\text{Trabuco}} = 1.25 V_{\text{Santiago}}$
2. If data at Santiago are not available use data from Laguna:  $V_{\text{Trabuco}} = 1.46 V_{\text{Laguna}}$

The relations above were applied only during periods of missing records and when records at the other stations showed measurable rainfall during the period of missing records. In many instances the period of missing records corresponded to an absence of measurable rainfall at the other stations, sometimes for quite extensive periods during the dry season. For this situation it was assumed that there was no measurable rainfall during the period of missing record. If during the period of missing data, rainfall was recorded at the alternate stations, then only data recorded during the missing period was transposed. All data recorded at the Trabuco gauge were retained in constructing the continuous record. In a few instances, missing records occurred simultaneously at all three stations. In this case the missing records were retained in the dataset. The duration of the retained missing records is minor compared to the total duration of the rainfall records.

Summary statistics of the original (unaltered) and extended precipitation data are compared in Table A-2. The extended records have few missing records, which is reflected by greater average annual rainfall and more storms per year. There are relatively minor differences in the average storm features (volume, duration, and intensity). This confirms that the additional (transposed) rainfall records do not appreciably change the storm characteristics of the stations.

**Table A-2: Comparison of Summary Statistics for Original and Constructed Rainfall Records at the Trabuco Gauge for WY 1949-2001**

	Average Annual Rainfall (in)	Total Missing Records (days)	Average Number of Storms per Year	Total Number of Storms:	Average Storm Volume (in):	Average Storm Duration (hrs):	Average Storm Intensity (in/hr)
Original Record	16.8	1762	18.1	958	0.86	11.6	0.086
Constructed Record	18.7	10	20.5	1084	0.85	11.6	0.087

#### A-2.4.3 Determination of Dry and Wet Cycles

Figure A-6 shows a plot of cumulative residuals (i.e. difference from the mean annual rainfall volume) for rainfall records at five gauges. The residual plots highlight dry periods, as indicated by decreasing cumulative residuals, and wet period, as indicated by increasing trends. Note that the plot for the El Toro gauge is shifted upward because available data from this gauge begins in 1965. For comparison among stations, the trend in the cumulative residuals is more informative than the magnitude of the residual. Trends in plots of cumulative residual for the Trabuco gauge are similar to trends in cumulative residual plots for rainfall data from the El Toro and Tustin gauges (unaltered). This indicates that the extended rainfall data at the Trabuco gauge captures

general dry and wet period trends as reflected in the historical data from El Toro and Tustin gauges.

The cumulative residual diagrams indicate a dry period from WY 1949-1978 and a general wet period from WY 1979-2000. The Baseline Conditions Report (RMV, February 2002) notes that the extended dry period began earlier in 1944, however the plots in Figure A-6 are based on available hourly data beginning in late 1948. The wet-period trend between WY 1978-2001 is intersected by a short period of rainfall deficits between 1984-1990. The following wet and dry periods are used for comparisons in this study:

- Dry periods: WY 1949-1977 and WY 1984-1990 (36 years total)
- Wet periods: WY 1978-1983 and WY 1991-2001 (17 years total)

#### A-2.4.4 Adjustment for Orographic Effects

The extended precipitation data at the Trabuco gauge were adjusted for orographic influence. A regression procedure was used to relate rainfall and elevation at the Trabuco, El Toro, and Laguna Beach gauges. Based on regression equations, the following expression was used to determine an elevation correction factor for precipitation data at the Trabuco gauge:

$$\frac{P_x}{P_{trabuco}} = 1 + \frac{0.0083(El_x - El_{trabuco})}{18.68}$$

where  $P_x$  is the average annual rainfall at a variable elevation denoted by  $El_x$ . This expression was used to construct continuous hourly precipitation data sets for a total of five representative elevations in the study area by multiplying the hourly rainfall at the Trabuco gauge by the correction factor obtained from the equation above. The selected elevations are between the elevations of the Laguna and Trabuco gauges; there was no extrapolation beyond this range. Table A-3 lists the representative elevations, correction factors, and average annual rainfall of the constructed datasets.

**Table A-3: Estimated Average Annual Rainfall by Elevation.**

Dataset	Elevation (ft)	Correction Factor	Average Annual Rainfall of Hourly Dataset (WY 49-01)
1 (Trabuco Gauge)	970	1	18.7
2	835	0.94	17.5
3	700	0.88	16.7
4	500	0.79	14.9
5	300	0.70	13.1

SWMM accounts for orographic effects on rainfall by assigning representative rainfall data (hyetographs) to each subcatchment area. For SWMM analysis of the study area sub-basins, each of the modeled subcatchment was assigned the closest of the five rainfall datasets

corresponding to the average subcatchment elevation. The average elevation of the subcatchment was obtained from the DEM of the subcatchment.

## **A-2.5 Soil Properties and Infiltration Parameters**

### **A-2.5.1 Soil Properties**

Soils information was obtained from the US Dept of Agriculture Soil Survey of Orange County and Western Part of Riverside County, California (1978). Digitized versions of the soils maps in GIS format were obtained from the USDA. The soils survey provides information about the distribution and physical properties of specific soil types. To simplify parameterization of the soils, the soil types were grouped into texture classes as identified in soil survey report. GIS based maps of soil textual class were developed.

Summit areas in portions Chiquita Canyon and Gobernadora Canyon have surficial deposits of expansive clays (hardpans). The perched hardpan clays expand as they become saturated, restricting infiltration and increasing surface runoff. The hardpan areas have been mapped by Morton (1974) and were recently field checked by personnel from Balance Hydrologics (Balance, 2003a). GIS maps of the perched hardpans were obtained from Balance Hydrologics.

The hardpan areas mapped by Morton generally correspond to Bosanko clays mapped in the USDA soil survey, however, there is some discrepancy in soil types between the two maps. The hardpan areas mapped by Morton were verified in field checks (Balance, 2003a), therefore, these areas were modeled as clay soils. All other areas were modeled with soils mapped in the USDA soil survey report.

The soil properties of each texture class were determined from a variety of literature information and are presented in Table A-4. The texture class value for saturated hydraulic conductivity is presented as a range to permit adjustment of this parameter during model calibration.

Infiltration-related input parameters are entered into SWMM on a subcatchment basis, i.e., infiltration is modeled in SWMM as occurring uniformly over the pervious region of each subcatchment. Thus the infiltration parameters are representative of average soil conditions over the entire subcatchment area. Average soil properties for each subcatchment were quantified with an aerial weighted average (i.e. percentage of area) of the texture properties listed in Table A-4.

Under post-developed conditions, grading in development areas would result in some blending and mixing of surficial soils and possibly deeper soil layers. The extent to which such mixing would occur is unknown, and therefore it is not possible to accurately estimate the distribution of soil properties under post-grading conditions. For modeling purposes, the USDA soil maps were used to determine the surficial soil distribution for both pre- and post- development conditions.

**Table A-4: Soil Properties of Soil Texture Classes**

Texture Class	Saturated Hydraulic Conductivity Range (in/hr) <sup>(2)</sup>	Hydraulic Conductivity Starting Value (in/hr)	Porosity <sup>(3)</sup>	Wilting Point <sup>(3)</sup>	Field Capacity <sup>(3)</sup>	Green-Ampt Entry Pressure (in) <sup>(2)</sup>
Clay	0.001 - 0.04	0.004	0.5	0.21	0.33	24
Loam	0.12 - 0.8	0.4	0.48	0.1	0.26	8
Clay loam	0.02 - 0.16	0.08	0.5	0.15	0.32	12
Silty clay loam	0.01 - 0.08	0.04	0.43	0.13	0.3	6
Sandy loam	0.4 - 3.9	2	0.41	0.05	0.17	3
Gravelly loam <sup>(1)</sup>	0.4 - 3.9	2	0.41	0.05	0.17	3
Loamy sand	2 - 7.9	5	0.4	0.04	0.14	1.5

(1) Used values for sandy loam.

(2) Determined from Rawls and Brakensiek (1989).

### A-2.5.2 Imperviousness

Impervious areas greatly influence the amount of runoff and infiltration from storm events. For development areas the percentage of impervious area was determined on the basis of land-use type. Recommended values from the Orange County Hydrology Manual (OCHM) (1986) were used where appropriate. Table A-5 lists the imperviousness fractions assigned to land-use type in the modeled areas. An average imperviousness for each subcatchment was calculated as an area-weighted average.

**Table A-5: Percent Impervious Coverage Values Used the SWMM Models**

Land Use	Percent Impervious Coverage
Natural or Agriculture <sup>1</sup>	0
Public Park <sup>1</sup>	15
Nursery	15
Golf Course	10-15
Golf Resort	65
School <sup>1</sup>	40
Single Family Residential <sup>2</sup>	40
Multi-Family Residential – Condominiums <sup>1</sup>	65
Multi-Family Residential – Apartments <sup>1</sup>	80
Commercial, Downtown Business or Industrial <sup>1</sup>	90
Existing Development	50
Quarry	30-90

1) OCHM recommended value

2) OCHM recommended value for 3-4 dwellings/acre

## A-2.6 Evapotranspiration

Available ET data was compiled and is summarized in Table A-6. The ET data were grouped into vegetation classes based on PWA Codes defined in Table 2-6 of the Baseline Hydrologic Conditions (PWA, May 2001). Some of the PWA classifications were further consolidated into broad vegetation groups because distribution and coverage of individual plant species is unknown and ET data for specific types of vegetation are limited. The ET data in Table A-6 are also differentiated by potential and actual ET rates. Potential ET is the amount of ET consumption that could occur if water availability is unrestricted. Actual ET is the measured ET rate for the specific measurement conditions.

ET is modeled by SWMM using potential ET rates specified on a monthly basis. The reference ET rates ( $ET_o$ ) used in this study were obtained from the California Irrigation Management Information System (CIMIS) website (CIMIS, 2003) and represent average year ET rates for grass as the reference crop. The reference ET rates are defined by region. The study area is located in reference ET zone 4 (south coast inland plains) (See Table A-6). For comparison, average monthly  $ET_o$  rates at the CIMIS Climate Station in Irvine are included in Table A-6. To estimate evapotranspiration rates for a specific plant types ( $ET_c$ ), the reference ET ( $ET_o$ ) is multiplied by the crop coefficient ( $K_c$ ):

$$ET_c = ET_o * K_c \quad (1)$$

$K_c$  is dependent on the plant and the season.  $K_c$  values have been determined for a wide variety of plant types (CIMIS, 2003). A similar approach is used by SWMM to calculate ET for different vegetation cover. The monthly  $ET_o$  rates are multiplied by a constant  $ET_o$  scaling factor ( $K_s$ ) that is defined on the subcatchment basis.  $K_s$  is analogous to  $K_c$  in eq 1, except that it is not allowed to be seasonally dependent and therefore is applied equally to all months. An area weighted scaling factor was determined for each subcatchment based on the percentage of each vegetation type in the subcatchment.

The  $ET_o$  scaling factors used in the SWMM model were estimated from literature information in Table A-6 and are grouped for vegetation classes based on PWA Codes. Table A-7 presents the vegetation group scaling factors used to determine area weighted scaling factors for each subcatchment. For comparison, Table A-7 also shows the associated annual ET for each vegetation group.

**Table A-6: Compilation of Monthly ET Rates for Various Vegetation Type**

PWA Code	Vegetation Cover / Conditions	Jan	Feb	Mar	Apr	May	Jun	July	Aug	Sept	Oct	Nov	Dec	Total	ET	k <sub>c</sub>	Source	Assumption/ Additional Information	
	CIMIS Reference ET	1.86	2.24	3.41	4.50	5.27	5.70	5.89	5.58	4.50	3.41	2.40	1.86	<b>46.62</b>	Potential		CIMIS	Reference ET for grass, Zone 4 (south coast inland plains)	
		2.24	2.45	3.67	4.73	5.17	5.91	6.35	6.17	4.62	3.57	2.71	2.30	<b>49.88</b>	Potential		CIMIS	Reference ET for grass, CIMIS Station 75 (Irvine), All data 1988-2001	
		2.56	2.84	4.05	4.25	5.09	5.75	6.54	5.49	4.45	2.93	2.69	2.45	<b>49.09</b>	Potential		CIMIS	Reference ET for grass, CIMIS Station 75 (Irvine), Dry Period 1988-1990	
		2.15	2.34	3.57	4.87	5.19	5.95	6.30	6.35	4.66	3.75	2.71	2.26	<b>50.09</b>	Potential		CIMIS	Reference ET for grass, CIMIS Station 75 (Irvine), Wet Period 1991-2001	
	Average Rainfall	4.24	3.92	3.25	1.32	0.43	0.15	0.04	0.13	0.39	0.37	1.91	2.52	<b>18.68</b>			Rainfall data	Average Rainfall at the Trabuco Station (WY 1949-2001)	
10201-10306	Natural Habitat													<b>19.60</b>	Actual		Bulletin 50 / Rainfall	Native Brush in Clay loam. Annual ET distributed monthly based on monthly rainfall	
														<b>16.50-19.10</b>	Actual		Bulletin 50 / Rainfall	Native Brush in Gravelly Sand. Annual ET distributed monthly based on monthly rainfall	
															<b>18.82-27.00</b>	Potential		Bulletin 50 / Rainfall	Native Brush in Gravelly Sand. Precipitation was supplemented with precipitation.
															<b>12.66-16.35</b>	Actual		Bulletin 50 / Rainfall	Native Brush in Rocky sandy loam. Annual ET distributed monthly based on monthly rainfall
		1.37	1.65	1.22	0.82	0.24	0.12	0.01	0.12	0.22	0.21	1.16	1.25	<b>7.16</b>	Actual		Hamilton, 2000	ET in Muddy Canyon (used CIMIS)	
		0.62	0.84	1.55	1.50	2.17	0.75	1.09	0.78	0.45	0.62	0.30	0.62	<b>11.28</b>	Actual		USGS, 2001	ET from desert-shrub (sagebrush, rabbitbrush) in NV not using groundwater	
		0.62	0.84	1.86	1.20	2.17	3.00	2.79	1.86	0.90	0.16	0.30	0.31	<b>16.01</b>	Potential		USGS, 2001	ET from saltgrass, rabbitbrush, wildrye, greasewood in NV using groundwater	
		0.00	0.03	0.19	0.76	1.93	3.10	3.23	2.08	0.78	0.19	0.03	0.00	<b>12.33</b>	Potential	0-0.55	Steinwand, 2001	ET of Three Shrubs (applied k <sub>c</sub> values to CIMIS)	
					2.22	2.53	3.0	1.39	1.26	1.10						Potential		Wight et al, 1986	Measured sagebrush/grassland with lysimeter in SW Idaho
0.26	0.31	0.47	0.62	0.72	0.78	0.81	0.77	0.62	0.47	0.33	0.26	<b>6.41</b>	Potential	0.138	CIMIS	Assumed sage scrub and chaparral are in equal acreage (VL and L mix)			
10401	Grassland	0.37	0.45	0.68	0.90	1.05	1.14	1.18	1.12	0.90	0.68	0.48	0.37	<b>9.32</b>	Potential	0.2	CIMIS	Assumes elymus and needlegrass	
															<b>10.0</b>	Potential		Bulletin 50	Native grass and weeds in gravelly loam (San Bernardino, 1928-29)
															<b>13.5-15.5</b>	Potential		Bulletin 50	Native grass and weeds in stony sand (Cucomonga, 1927-30)
															<b>12.58</b>	Potential		Bulletin 50	Native grass and weeds in fine sandy loam (Anaheim, 1927-28)
															<b>12.7-14.1</b>	Potential		Bulletin 50	Native grass and weeds in sand (Ontario, 1927-28)
															<b>13.3-13.9</b>	Potential		Bulletin 50	Native grass and weeds in loam (Cucomonga & Wineville, 1927-28)
															<b>9.84</b>	Actual		Wever et al, 2002	ET for grasslands in Canada
10501 & 10502	Woodland and Riparian Habitat & Riparian Willow	0.93	1.12	1.71	2.25	2.64	2.85	2.95	2.79	2.25	1.71	1.20	0.93	<b>23.31</b>	Potential	0.5	CIMIS	assumes 1/3 Riparian Habitat (willow, cottonwood) and 2/3 Woodland (sycamore, oak, alder)	
		1.21	1.46	2.22	2.93	3.43	3.71	3.83	3.63	2.93	2.22	1.56	1.21	<b>30.30</b>	Potential	0.65	CIMIS	Assumed willow and cottonwood	
															<b>36.51</b>	Potential		Scott, et al., 2000	ET of willows/cottonwood/mesquite in AZ (max temp 76.64 °F)
			2.00	3.92	5.72	4.76	4.48	7.34	7.80	6.63	5.36	3.54	2.12	<b>53.67</b>	Potential		Bulletin 50	ET of red willows measured in Santa Ana (11 months: July 1930-June 1931)	
10503	Forest (Woodland)													<b>47.09</b>	Potential		Scott, et al., 2000	ET of willows growing next to a river in AZ (max temp 76.64 °F)	
		0.65	0.78	1.19	1.58	1.84	2.00	2.06	1.95	1.58	1.19	0.84	0.65	<b>16.32</b>	Potential	0.35	CIMIS	Assumed oak, alder, sycamore, needlegrass, and elymus grass	
															<b>24.45</b>	Potential		Scott, et al., 2000	ET of mesquite growing next to a river in AZ (max temp 76.64 °F)
															<b>75.4</b>	Potential		Lewis et al, 2000	ET for oak growing in sierra Nevada near Sacramento
													<b>14.49</b>	Actual		Lewis et al, 2000	ET for oak growing in sierra Nevada near Sacramento		
10601	Meadow and Marsh	0.62	0.84	2.79	4.20	5.27	7.95	10.08	7.75	4.95	2.33	1.20	0.62	<b>48.59</b>	Potential		USGS, 2001	ET from bulrush marsh in Nevada	
															<b>63.3</b>	Potential		Bulletin 50	Estimated consumptive use by round and triangular stem tules and cattails in Santa Ana (adjusted for large area)
20101	General Agriculture	0.47	2.15	3.58	3.85	2.09	0.00	0.00	0.00	0.00	0.00	0.79	0.71	<b>13.65</b>	Potential	0.2 - 1.05	CIMIS	Assumes barley. Growing season November 1 to May 30	
20401	General Orchards	1.28	1.55	2.35	3.11	3.64	3.93	4.06	3.85	3.11	2.35	1.66	1.28	<b>32.17</b>	Potential	0.69	CIMIS	Assumes Citrus (Lemons)	
30201-30203	Residential													<b>27.0</b>	Potential	0.58	Santa Margarita Water District	Landscape vegetation Assumed 25% shrubs, 75% turf, using landscape coefficients of 0.5 for shrubs, and 0.81 for turf.	
30501	General Parks (Golf)	1.02	1.21	2.59	3.24	4.16	3.88	4.18	3.96	2.79	1.84	1.39	1.02	<b>31.29</b>	Potential	0.54-	CIMIS	Assumes Bermuda Grass or Paspalum	

PWA Code	Vegetation Cover / Conditions	Jan	Feb	Mar	Apr	May	Jun	July	Aug	Sept	Oct	Nov	Dec	Total	ET	k <sub>c</sub>	Source	Assumption/ Additional Information
	Courses)															0.71		
														28.2-34.4	Actual		Bulletin 50	Bermuda Grass grown in San Bernardino
														37.0	Potential	0.81	Santa Margarita Water District	Landscape coefficient for turf

References:

Bulletin No. 50. 1942. Use of water by native vegetation. State of California, Department of Public Works, Division of Water Resources.

CIMIS. 2003. [www.cimis.water.ca.gov](http://www.cimis.water.ca.gov)

Hamilton, D. 2000. The response of the Muddy Canyon (Crystal Cove Area, California) watershed water balance to multi-decadal shifts in climate/rainfall patterns and development. Report prepared for LSA Associates, Inc.

Lewis, D., M.J. Singer, R.A. Dahlgren, and K.W. Tate. 2000. Hydrology in a California oak woodland watershed: a 17-year study. *Journal of Hydrology*. 240:106-117.

Santa Margarita Water District, 2003. Preliminary Landscape Irrigation Water Usage Analysis 2001.

Scott, R.L., W.J. Shuttleworth, D.C. Goodrich, and T. Maddock III. 2000. The water use of two dominant vegetation communities in a semiarid riparian ecosystem. *Agricultural and Forest Meteorology*. 105:241-256.

Steinwand, A.L., R.F. Harrington, and D.P. Groeneveld. 2001. Transpiration coefficients for three Great Basin Shrubs. *Journal of Arid Environments*. 49:555-567.

USGS Water-Resources Investigations Report 01-4195. 2001. R.J. Laczniak, J.L. Smith, P.E. Elliot. G.A. DeMeo, M.A. Chatigny, US Geological Survey, and G.J. Roemer, GeoTrans. Ground-water discharge determined from estimates of evapotranspiration, Death Valley Regional Flow System, Nevada and California. [water.usgs.gov/pubs/wri/wri014195/index.htm](http://water.usgs.gov/pubs/wri/wri014195/index.htm)

Waterright. 2003. [www.waterright.org/site2/reference/selectcrop.asp](http://www.waterright.org/site2/reference/selectcrop.asp)

Wever, L.A., L.B. Flanagan, and P.J. Carlson. 2002. Seasonal and interannual variation in evapotranspiration, energy balance and surface conductance in a northern temperate grassland. *Agriculture and Forest Meteorology* 112: 31-49.

Wight, J.R., C.L. Hanson, and K.R. Cooley. 1986. Modeling evapotranspiration from sagebrush-grass rangeland. *Journal of range management*. 39(1):81-85.



**Table A-7: Vegetation Group Et, Scaling Factor and Annual ET**

PWA Code Vegetation Cover	Vegetation Group	Scale factor (K <sub>s</sub> )		Annual ET	
		Estimated Range	Representative Value	Estimated Range	Representative Value
10201-10306	Scrub &	0.3-0.5	0.4	14.0-23.3	18.6
10401	Grassland	0.2-0.3	.25	9.3-14.0	11.6
10501 & 10502	Woodland & Riparian	0.9-1.2	1.1	42.0-55.9	51.3
10503	Forest (Woodland)	0.3-0.4	0.35	14.0-18.6	16.3
10601	Meadow and Marsh	0.9-1.2	1.0	42.0-55.9	46.6
20101, 20201, 20302	Agriculture	0.3-0.7	0.6	14.0-32.6	28.0
20401	Orchard		0.69		32.2
30201-30203	Residential		0.58		
30501	Park / Golf Course	0.6-0.81	0.73	30.37.8	34.0

**A-2.7 Irrigation**

Water usage for landscape irrigation in development areas was quantified with information from the Santa Margarita Water District Landscape Irrigation Water Usage Analysis (2003a). In this study water usage for landscape irrigation was metered for a total of 867 domestic and non-domestic users. The landscape area receiving irrigation was verified for a fraction of the accounts. Results summarized in Table A-8 show that the top 25 users with verified landscape areas used on average about 64-inches/unit area of water for landscape irrigation in 2001. This value drops substantially to about 41-inches/unit area for the top 100 users with verified landscape areas, indicating considerable over-watering by the top 25 users. The average annual water usage for landscape irrigation in 2001 by all monitored domestic and non-domestic users (867 accounts), including accounts with non-verified areas and under-usage was about 50-inches/unit area.

**Table A-8: Average Annual Water Usage for Landscape Irrigation**

	Verified Areas for All Uses	Total Area (acres)	Annual Water Usage (in/area)	Annual Water Usage (acre-ft)	Budgeted Water Usage (acre-ft)	Potential Savings (%)
<b>Top 25 users with verified areas:</b>						
Domestic (16 accounts)	Yes	25.96	63.84	138.08	77.98	44 %
Non-domestic (9 accounts)		19.20	64.38	103.42	57.67	44 %
Total (25 accounts)		45.17	64.2	241.5	135.65	44 %
<b>Top 100 users with verified areas:</b>						
Domestic (57 accounts)	Yes	68.75	42.72	244.71	206.48	27 %
Non-domestic (43 accounts)		64.86	38.64	208.79	194.81	25 %
Total (100 accounts)		133.61	40.62	453.50	453.5	26 %
<b>All users excluding accounts with under usage</b>	No					

	Verified Areas for All Uses	Total Area (acres)	Annual Water Usage (in/area)	Annual Water Usage (acre-ft)	Budgeted Water Usage (acre-ft)	Potential Savings (%)
Domestic (408 accounts)		322.95	67.92	1828	1064	42 %
Non-domestic (166 accounts)		289.85	62.28	1503	955	36 %
Total (574 accounts)		612.8	65.28	3331	2020	39 %
<b>All users</b>						
Domestic (566 accounts)	No	552.26	53.76	2474	1820	26 %
Non-domestic (301 accounts)		621.75	47.28	2448	2049	16 %
Total (867 accounts)		1174.01	50.28	4922	3869	19 %

Source: Santa Margarita Water District (2003)

The Santa Margarita Water District Study includes an analysis of the potential water saving if efficient irrigation practices are adopted. Such practices include the use drought tolerant plants and irrigation controllers that use real-time weather data to adjust irrigation schedules. The water budget for landscape irrigation shown in Table A-8 indicates that potential savings from efficient irrigation practices ranges from about 20-40 %. The water budgets calculated in the Santa Margarita Water District Study are based on the following assumptions and calculations:

1. The water required by landscape irrigation was determined by calculating the  $ET_{lv}$  requirements of landscape vegetation using equation 1.

$$ET_{lv} = ET_o * K_c \quad (1)$$

A value of 45.71 inches was used for the  $ET_o$ . The crop coefficient ( $K_c$ ) for landscape vegetation was 0.5775, which is based on the assumption that 25% of the landscape consists of turf ( $K_c=0.81$ ) and 75% is shrubs ( $K_c=0.5$ ).

2. A portion of the annual precipitation contributes to irrigation of the landscape vegetation, but not all of the rainfall will contribute to landscape irrigation because only a portion will penetrate the soil surface and will be usable to the plants. This fraction is known as the effective rainfall. The Santa Margarita Water District found that of the 12.85 inches of precipitation in 2001, 24% (3.04 inches) was effective in reducing the irrigation requirements of landscape vegetation.
3. The irrigation water usage per unit area (WU) is calculated as the ET requirements less the effective rainfall (ER), divided by the irrigation efficiency factor (Eff):

$$WU_{lv} = (ET_{lv} - ER) / \text{Eff} \quad (2)$$

The irrigation efficiency factor accounts for losses such as evaporation and runoff from over watering and non-uniform watering. Irrigation efficiency can range from 30 to 90% depending on the type of irrigation system (e.g. spray head, drip,), the application rate

and distribution. An irrigation efficiency of 65% was used in the Santa Margarita Water District Analysis (2003).

The Santa Margarita Water District also conducted an analysis of monthly water usage of the top 25 users of all accounts to highlight potential water savings. Table A-9 shows the monthly irrigation budget analysis, as well as the monthly water usage and potential savings of the top 25 water users (without verified areas).

**Table A-9: Average Monthly Water Usage for Landscape Irrigation**

	Jan	Feb	Mar	Apr	May	Jun	Jul	Aug	Sep	Oct	Nov	Dec	Total
Monthly Irrigation Budget for 2001*													
Monthly ETo (inches)	2.35	1.95	3.12	4.03	4.81	5.8	6.12	5.95	4.59	3.11	1.94	1.94	45.71
Crop Coefficient for Turf	0.61	0.65	0.85	1	1	0.95	0.9	0.85	0.8	0.72	0.69	0.6	
Crop Coefficient for Scrubs	0.5	0.5	0.5	0.5	0.5	0.5	0.5	0.5	0.5	0.5	0.5	0.5	
Composite Crop Coefficient (25% turf, 75% scrubs)	0.5275	0.5375	0.5875	0.6250	0.6250	0.6125	0.6000	0.5875	0.5750	0.5550	0.5475	0.5250	
Monthly ET of landscape vegetation (inches) (ETo x Crop Coefficient)	1.24	1.05	1.83	2.52	3.01	3.55	3.67	3.50	2.64	1.73	1.06	1.02	26.81
Monthly rainfall - 2001 (inches)	3.39	5.48	0.3	1.01	0.21	0.02	0	0	0	0	1.02	1.42	12.85
Effective Rainfall (24% x rainfall)	0.81	1.32	0.07	0.24	0.05	0.00	0.00	0.00	0.00	0.00	0.24	0.34	3.08
Assumed irrigation efficiency	0.65	0.65	0.65	0.65	0.65	0.65	0.65	0.65	0.65	0.65	0.65	0.65	
Monthly irrigation requirement (inches)	0.66		2.71	3.50	4.55	5.46	5.65	5.38	4.06	2.66	1.26	1.04	36.92
Monthly Water Usage by Top 25 Accounts*													
Water Usage (inches/unit area)	2.43	1.06	4.22	5.87	10.30	12.94	14.37	11.94	10.80	7.15	3.43	3.20	87.71
Budgeted Water Usage (from above)	0.66		2.71	3.50	4.55	5.46	5.65	5.38	4.06	2.66	1.26	1.04	36.92
Potential Savings (inches/unit area)	1.77	1.06	1.51	2.37	5.76	7.48	8.72	6.57	6.74	4.49	2.17	2.16	50.80
Potential Saving (%)	73%	100%	36%	40%	56%	58%	61%	55%	62%	63%	63%	67%	58%
Monthly Water Usage Used in SWMM Model													
Average monthly rainfall (1949-2001)	3.38	3.13	2.60	1.06	0.35	0.13	0.03	0.10	0.31	0.29	1.53	2.02	14.93
Average Effective Rainfall (24%)	0.81	0.75	0.62	0.25	0.08	0.03	0.01	0.02	0.08	0.07	0.37	0.48	3.58
Crop Coefficient for Golf Courses, Parks and Schools (100% turf)	0.61	0.65	0.85	1	1	0.95	0.9	0.85	0.8	0.72	0.69	0.6	
Crop Coefficient for Landscape Areas in Residential & Commercial Development (50% turf, 50% scrubs)	0.555	0.575	0.675	0.750	0.750	0.725	0.700	0.675	0.650	0.610	0.595	0.550	
Irrigation Efficiency for Golf Courses, Parks and Schools	0.73	0.73	0.73	0.73	0.73	0.73	0.73	0.73	0.73	0.73	0.73	0.73	
Irrigation Efficiency for Residential & Commercial Areas	0.65	0.65	0.65	0.65	0.65	0.65	0.65	0.65	0.65	0.65	0.65	0.65	
Monthly Irrigation Requirement for Residential & Commercial Development Areas (inches/unit area)	0.76	0.57	2.28	4.26	5.42	6.42	6.58	6.14	4.47	2.81	1.21	0.90	41.8
Monthly Irrigation Requirement for Golf Courses, Parks, and Schools (inches/unit area)	0.85	0.71	2.78	5.17	6.47	7.51	7.54	6.89	4.93	2.97	1.33	0.93	48.0

\* From the Santa Margarita Water District Landscape Irrigation Water Usage Analysis (2003a)

## DRAFT

The impacts of landscape irrigation on the water balance and hydromodification was assessed through the continuous simulation of the 53-year rainfall record using SWMM. For modeling purposes, it was assumed that all irrigation water is imported into the subcatchments. The rate of irrigation was calculated on a monthly basis using the monthly irrigation volumes shown in Table A-9. Following the approach used in the Santa Margarita Water District Plan of Works (2003b), an annual irrigation depth of about 42 inches was used for residential and commercial development areas, and an annual irrigation depth of about 48 inches was used for golf courses, parks, and schools. The monthly apportionment of these annual depths (Table A-9) is based on the Santa Margarita Water District irrigation budget described above. However, in order to approximately match the annual depths used in the Plan of Works Report, the irrigation efficiency for turf was increased to 0.73 and a 50/50 mix of turf and scrubs was assumed for residential and commercial development areas (see Table A-9).

The areas receiving irrigation are based on information obtained from the Santa Margarita Water District Plan of Works (2003b) and were defined in the model as a percentage of the pervious region of each land-use in the development areas (see Table A-10). For modeling purposes a daily irrigation period of four hours was assumed. Irrigation was not modeling during periods of rainfall.

**Table A-10: Irrigated Fraction of Development Areas and Annual Irrigation Depths**

Land Use	Percent Impervious	Percent Pervious	Percent Pervious Area Irrigated	Percent Total Area Irrigated*	Annual Irrigation Depth (inches)*
Golf Course	10	90	55.56	50	48.0
Parks	15	85	58.82	50	48.0
School	40	60	83.33	50	48.0
Transportation	100	0	0	0	
Single Family Residential	40	60	41.67	25	41.8
Multi-Family Residential	65	35	100	35	41.8
Estate	20	80	25	20	41.8
Water Treatment Plant	60	40	0	0	
Commercial	72.5	27.5	100	27.5	41.8

- From the Santa Margarita Water District Plan of Works (2003b)

### A-2.8 Model Calibration

The SWMM hydrologic simulation model was calibrated to three types of available streamflow measurements:

1. **Dry-Weather Base Flows.** Balance Hydrologics measured dry-weather base flows at various drainages throughout RMV (Balance, 2001). Flows measured between November 1999 and May 2000 were used for model calibration.
2. **Indirect Wet-weather Peak Discharge Estimates.** Balance Hydrologics estimated wet-weather peak discharges from measured high-water marks collected on various drainages throughout RMV (Balance, 2003b). The indirect peak discharge estimates from storms between February 1998 and February 2000 were used for model calibration.

## DRAFT

- 3. Continuous Stream Flow Hydrographs.** Wildermuth Environmental (2003) conducted continuous flow monitoring at two locations in RMV during the 2003 rainy season. Flow measurements collected on Gobernadora Creek downstream of Coto de Caza were used to calibrate the hydrologic model of this area.

Model calibration entailed systematically varying selected SWMM input parameters and comparing the measured discharge values to the corresponding value in continuous output hydrograph generated by SWMM. The selected calibration parameters were the groundwater storage volume, subsurface conductivity, overland flow roughness, and surface depression storage. These parameters are not easily quantified and subject to uncertainty. Parameters that were readily quantified from GIS mapping (e.g. slope, elevation, soil and vegetation distribution) were not varied.

The most sensitive calibration parameters were found to be those that affected the groundwater storage volume (thickness, field capacity, porosity) the rate of downward percolation, and lateral movement to the stream channel (conductivity, lateral flow length). These parameters affected predictions of both base flows and peak discharges.



### A-3 HYDROLOGIC SIMULATION PARAMETERS AND SWMM CALIBRATION RESULTS OF THE MODELED SUB-BASINS

The SWMM model was used for continuous hydrologic simulation of the study area watersheds. SWMM models were developed separately for areas delineated on the basis of major watershed drainage boundaries. The RMV planning areas (Figure A-7) sometimes span major drainage basins, in which case portions of the planning area were divided between different SWMM model boundaries. Table A-11 lists the modeled watersheds and the planning areas included in the SWMM model. The subsequent sections describe the SWMM model inputs and calibration results of the modeled watersheds.

**Table A-11: Modeled Watershed Areas**

Name of Modeled Area	Major Drainage Channel	Planning Areas Included in Model
Cañada Chiquita Model	Chiquita Creek	PA-2
Cañada Gobernadora Model	Gobernadora Creek	PA-2, PA-3
Central San Juan Model	San Juan Creek, Trampas Creek	PA-3, PA-4, PA-5
Cristianitos Model	Cristianitos Creek	PA-6, PA-7
Gabino/Blind Canyon Model	Gabino and Blind Canyon Creeks	PA-7, PA-8
Talega Development Area Model	Talega and Blind Canyon Creeks	PA-8A and PA-8B

#### A-3.1 SWMM Model of the Cañada Chiquita Sub-Basin

##### A-3.1.1 Cañada Chiquita Model - Subcatchment Delineation

The Chiquita Canyon SWMM Model is defined by the catchment area that is directly tributary to Chiquita Creek, and development area immediately south of Chiquita Canyon that is directly tributary to San Juan Creek (see Figure A-8). The majority of PA-2 is in this watershed area. Development plans for PA-2 are the most detailed of any currently available, including detailed plans for grading, development types, and distribution.

The 4000-acre Chiquita Canyon watershed was divided into 18 subcatchments as shown in Figure A-8. Catchment 1-17 are tributary to Chiquita Creek and catchment 18 drains to San Juan Creek. Different subcatchment areas and shapes were delineated for pre- and post-development areas because grading plans alter the topographic boundaries between drainage subcatchments.

The 18 subcatchments were disaggregated into valley and ridge subcatchments, as well as, subcatchments based on land-use designation. Table A-12 and Table A-13 lists the parameters of the modeled subcatchments for the pre- and post-development scenarios, respectively.

DRAFT

**Table A-12: Cañada Chiquita Model – Pre-Development Subcatchment Parameters**

Sub-catchment		Area (acres)	Average Slope (ft/ft)	Percent Impervious	Hydraulic Conductivity (in/hr)	ET Scale Coefficient
Name	Land Use					
1-Valley	Open Space	24.5	0.079	0.0	1.4	0.72
1-Ridge	Open Space	156.6	0.303	0.0	1.8	0.40
2-Valley	Open Space	61.8	0.086	0.0	1.6	0.61
2-Ridge	Open Space	157.8	0.29	0.0	2.0	0.40
3-Valley	Open Space	66.7	0.147	0.0	1.5	0.67
3-Ridge	Open Space	170.3	0.294	0.0	1.9	0.49
4-Valley	Open Space	33.1	0.089	0.0	2.2	0.74
4-Ridge	Open Space	231.5	0.299	0.0	0.7	0.45
5-Valley	Open Space	21.8	0.056	0.0	1.0	0.71
5-Valley	School	20.9	0.055	40.0	0.9	0.35
5-Ridge	Open Space	138.4	0.282	0.0	0.6	0.47
6-Valley	Open Space	26.3	0.101	7.4	1.0	0.56
6-Valley	School	16.8	0.101	40.0	0.2	0.35
6-Ridge	Open Space	113.6	0.271	0.0	0.6	0.47
6-Ridge	Transportation	2.9	0.271	100.0	0.7	0.00
7-Valley	Open Space	57.1	0.097	0.0	1.1	0.65
7-Ridge	Open Space	410.1	0.241	0.0	1.3	0.50
8-Valley	Open Space	162.5	0.09	0.0	1.7	0.61
8-Valley	Transportation	2.0	0.09	100.0	2.2	0.00
8-Ridge	Open Space	552.9	0.232	0.0	2.2	0.49
8-Ridge	Transportation	2.1	0.232	100.0	2.2	0.00
9-Valley	Open Space	116.2	0.102	0.0	1.7	0.61
9-Valley	School	21.7	0.232	40.0	1.1	0.35
9-Valley	Transportation	1.2	0.1	100.0	2.2	0.00
9-Ridge	Open Space	201.0	0.246	0.0	2.2	0.49
9-Ridge	Transportation	1.0	0.246	100.0	2.1	0.00
10-Valley	Open Space	13.7	0.095	0.0	2.2	0.60
10-Ridge	Open Space	153.5	0.245	0.0	2.2	0.44
11-Valley	Open Space	40.3	0.071	0.0	2.2	0.62
11-Ridge	Open Space	79.3	0.244	0.0	2.2	0.49
12-Valley	Open Space	30.7	0.119	0.0	1.8	0.59
12-Ridge	Open Space	187.4	0.235	0.0	1.7	0.50
13-Valley	Open Space	35.9	0.077	0.0	0.9	0.57
13-Ridge	Open Space	91.8	0.249	0.0	0.1	0.55
14-Valley	Open Space	24.2	0.114	0.0	0.5	0.55
14-Ridge	Open Space	146.2	0.255	0.0	0.1	0.55
15-Valley	Open Space	23.6	0.101	0.0	2.0	0.55
15-Valley	POWTP	24.9	0.101	72.5	0.5	0.16
15-Ridge	Open Space	100.4	0.249	1.5	0.4	0.48
15-Ridge	Parks	55.8	0.249	15.0	0.4	0.62
16-Valley	Open Space	15.8	0.115	5.1	1.6	0.57
16-Ridge	Open Space	136.2	0.265	16.4	1.1	0.46
17-Valley	Open Space	17.2	0.122	0.0	2.3	0.59
17-Ridge	Open Space	68.8	0.275	0.5	1.3	0.63
18-Valley	Open Space	62.2	0.018	0.0	2.3	0.76
18-Ridge	Open Space	123.5	0.215	0.0	2.0	0.58

DRAFT

**Table A-13: Cañada Chiquita Model – Post-Development Subcatchment Parameters**

Sub-catchment		Area (acres)	Average Slope (ft/ft)	Percent Impervious	Hydraulic Conductivity (in/hr)	ET Scale Coefficient
Name	Land Use					
1-Valley	Open Space	24.5	0.079	0.0	1.4	0.63
1-Ridge	Open Space	156.6	0.303	0.0	1.8	0.40
2-Valley	Open Space	51.7	0.086	0.0	1.6	0.58
2-Valley	Golf Course	10.0	0.080	15.0	1.5	0.62
2-Ridge	Open Space	157.8	0.290	0.0	2.0	0.40
3-Valley	Open Space	51.2	0.147	0.0	1.4	0.55
3-Valley	Golf Course	16.9	0.109	15.0	1.6	0.62
3-Ridge	Open Space	168.8	0.294	0.0	1.9	0.49
4-Valley	Open Space	23.7	0.089	0.0	2.4	0.65
4-Valley	Golf Course	25.7	0.067	15.0	1.8	0.62
4-Ridge	Open Space	215.3	0.299	0.0	0.7	0.44
5-Valley	Open Space	15.6	0.056	0.0	0.8	0.70
5-Valley	Golf Course	8.5	0.055	15.0	1.5	0.62
5-Valley	School	20.9	0.055	40.0	0.9	0.35
5-Ridge	Open Space	136.1	0.282	0.0	0.6	0.46
6-Valley	Open Space	26.3	0.101	7.4	1.0	0.56
6-Valley	School	16.8	0.101	40.0	0.2	0.35
6-Ridge	Open Space	113.6	0.271	0.0	0.6	0.47
6-Ridge	Transportation	2.9	0.271	100.0	0.7	0.00
7-Valley	Open Space	57.1	0.097	0.0	1.1	0.65
7-Ridge	Open Space	410.1	0.241	0.0	1.3	0.50
8-Valley	Open Space	162.5	0.090	0.0	1.7	0.61
8-Valley	Transportation	2.0	0.090	100.0	2.2	0.00
8-Ridge	Open Space	552.9	0.232	0.0	2.2	0.49
8-Ridge	Transportation	2.1	0.232	100.0	2.2	0.00
9-Valley	Open Space	74.0	0.102	0.0	1.8	0.63
9-Valley	MF Residential	33.1	0.051	65.0	1.7	0.20
9-Valley	Parks	3.2	0.040	15.0	1.9	0.62
9-Valley	School	21.7	0.102	40.0	1.1	0.35
9-Valley	Transportation	11.7	0.100	100.0	1.5	0.00
9-Valley	Golf Course	2.3	0.060	15.0	2.2	0.62
9-Ridge	Open Space	185.1	0.246	0.0	2.2	0.49
9-Ridge	Transportation	9.0	0.246	100.0	2.2	0.00
10-Valley	Open Space	10.6	0.095	0.0	2.2	0.61
10-Valley	Golf Course	2.8	0.063	15.0	2.2	0.62
10-Ridge	Open Space	139.1	0.245	0.0	2.2	0.43
10-Ridge	Estate	11.1	0.089	20.0	2.2	0.46
10-Ridge	Transportation	4.2	0.143	100.0	2.2	0.00
11-Valley	Open Space	26.9	0.071	0.0	2.2	0.63
11-Valley	Golf Course	14.0	0.040	15.0	2.2	0.62
11-Ridge	Open Space	44.0	0.244	0.0	2.2	0.50
11-Ridge	Estate	20.1	0.077	20.0	2.2	0.46
11-Ridge	Transportation	3.1	0.064	100.0	2.2	0.00
12-Valley	Open Space	10.9	0.119	0.0	2.1	0.59
12-Valley	Golf Course	22.5	0.061	15.0	1.4	0.62
12-Ridge	Open Space	174.3	0.235	0.0	1.7	0.48
12-Ridge	Estate	23.8	0.095	20.0	1.0	0.46
12-Ridge	Transportation	11.7	0.063	100.0	1.4	0.00
13-Valley	Open Space	23.3	0.077	0.0	1.2	0.56
13-Valley	Golf Course	17.5	0.064	15.0	0.2	0.62
13-Ridge	Open Space	58.9	0.249	0.0	0.1	0.54
13-Ridge	Estate	28.9	0.087	20.0	0.05	0.46

DRAFT

Sub-catchment		Area (acres)	Average Slope (ft/ft)	Percent Impervious	Hydraulic Conductivity (in/hr)	ET Scale Coefficient
Name	Land Use					
14-Valley	Open Space	11.7	0.114	0.0	0.8	0.49
14-Valley	Golf Course	14.0	0.066	15.0	0.2	0.62
14-Ridge	Open Space	100.6	0.255	0.0	0.2	0.54
14-Ridge	Estate	29.7	0.097	20.0	0.1	0.46
15-Valley	Open Space	24.1	0.101	0.0	2.0	0.55
15-Valley	POWTP	23.6	0.101	60.0	0.5	0.23
15-Ridge	Open Space	100.3	0.249	1.3	0.4	0.48
15-Ridge	Parks	55.8	0.249	15.0	0.4	0.62
16-Valley	Open Space	11.9	0.115	6.8	1.7	0.57
16-Ridge	Open Space	36.1	0.265	16.6	1.2	0.47
16-Ridge	Residential	90.2	0.043	40.0	1.3	0.35
16-Ridge	Parks	2.9	0.09	52.5	0.3	0.35
16-Ridge	School	3.3	0.038	40.0	1.3	0.35
17-Valley	Open Space	17.3	0.122	0.0	2.3	0.59
17-Ridge	Open Space	31.7	0.275	1.0	1.5	0.72
17-Ridge	School	7.7	0.036	40.0	0.2	0.35
17-Ridge	Residential	26.7	0.045	40.0	1.0	0.35
17-Ridge	Parks	12.7	0.032	15.0	0.3	0.62
18-Valley	Open Space	59.5	0.018	0.0	1.1	0.75
18-Valley	Transportation	2.7	0.215	100.0	0.8	0.00
18-Ridge	Open Space	59.5	0.215	0.0	2.1	0.59
18-Ridge	Residential	44.5	0.215	40.0	2.2	0.35
18-Ridge	Transportation	15.4	0.215	100.0	2.2	0.00
18-Ridge	Commercial	3.4	0.215	60.0	2.2	0.23
18-Ridge	Parks	1.1	0.37	15.0	3.0	0.62

**A-3.1.2 Cañada Chiquita Model - Land-Use**

Pre- and post-development land-use in Cañada Chiquita is shown in Figure A-7 and tabulated in Table A-14. The modeled pre-development conditions are based on the PWA land-use maps. For pre-development conditions, the lower half of the Canyon is predominantly used for agriculture and the upper half is open space grassland and native vegetation. Existing development includes the publicly owned treatment plant, the Arroyo Trabuco High School, and roads.

The modeled development conditions were based on the B4 development alternative, the B4 principle roads plan, and the habitat restoration plan. These proposed development and habitat restoration plans were superimposed on the PWA land-use maps for existing conditions. The modeled post-development conditions are the amalgamation of these existing and proposed land-uses.

The proposed development includes single and multi-family residential housing, estates, and a golf course. The main arterial road in PA-2 is a six-lane highway with an assumed impervious width of 120 feet. Detailed information about the specific development types and distribution was incorporated into the model. Additionally, there are significant areas in the Chiquita Canyon

that are proposed for restoration with native vegetation under post-development conditions. This information was also incorporated into the SWMM model in terms of the effect on ET.

**Table A-14: Cañada Chiquita Model – Pre- and Post- Development Land Use**

<b>PWA Code</b>	<b>Land-Cover</b>	<b>Pre-Development Scenario (acres)</b>	<b>Post-Development Scenario (acres)</b>
20101, 20201, 20202, 20401	Agriculture & Orchard	1913	1442
10201-10306	Scrub & Chaparral	1718	1701
10401	Grassland	200	187
10501-10502, 10601	Woodland, Riparian, Forest, Meadow & Marsh	196	182
30202	Single Family Residential		117
30203	Multi-Family Residential		33
30202	Estate		90
30101	School	59	70
30401	Transportation	11	40
30101	Development - (treatment plant)	24	24
30501	Park	56	73
30501	Golf Course		134
	Undefined	23	74

**A-3.1.3 Cañada Chiquita Model - Soils**

The distribution of soil texture is shown in Figure A-9. Sandy soils are predominant in the upper half of the canyon with some clay loam soils on the ridges in the western side of the canyon. Clay loam and clay soils comprise a large portion of the lower half of the canyon, especially of the eastern side of the canyon. Hardpan clays mapped by Morton (1974) are also concentrated in these areas. Comparison of soil texture map (Figure A-9) and the land use coverage map (Figure A-8) shows that much of the proposed residential and estates development is in clayey terrain.

**A-3.1.4 Cañada Chiquita Model - Calibration**

The Chiquita Canyon Model was calibrated to dry-weather low flow measurements (Balance, 2001) and peak discharge estimates based on observations of high water marks (Balance, 2003b). Calibration results are presented in Table A-15 below.

**Table A-15: Cañada Chiquita Model – Calibration Data and Calibration Results**

<b>Flow Condition / Location</b>	<b>Date</b>	<b>Time</b>	<b>Measured or Estimated Discharge (cfs)</b>	<b>Predicted Discharge from SWMM (cfs)</b>
<b><u>Low Flow</u></b>				
Narrows	5/4/2000	11:22	0.29	0.28
Lower Chiquita	11/17/1999	17:00	0.2	0.20
	5/4/2000	10:30	0.33	0.32
<b><u>Peak Discharge</u></b>				
Narrows	2/23/1998	--	428	398
	2/21/2000	--	23	24
Lower Chiquita	2/23/1998	--	1900	1624
	2/21/2000	--	103	121

**A-3.2 SWMM Model of the Cañada Gobernadora Sub-Basin**

**A-3.2.1 Cañada Gobernadora Model - Subcatchment Delineation**

The Cañada Gobernadora SWMM Model is defined by the catchment area that is directly tributary to Gobernadora Creek. The approximately 7100-acre Gobernadora model includes large areas of existing upstream development outside of the RMV Boundary. Upper Gobernadora Canyon upstream of the RMV boundary is approximately 3900 acres, with a high proportion of development (Coto de Caza). The 1000-acre Wagonwheel Canyon is a major tributary joining Gobernadora Creek near the upstream RMV boundary. Wagonwheel Canyon also has significant areas of existing development. The RMV project area that is directly tributary to Gobernadora Creek is approximately 2200 acres. The proposed development areas are within PA-3 and PA 2 (Figure A-7).

The 7100-acre Gobernadora Canyon watershed was divided into 12 subcatchments as shown in Figure A-10. The off-site areas in Upper Gobernadora (Coto de Caza) and in Wagonwheel Canyon were each modeled as single large subcatchments. The parameters of the Coto de Caza subcatchment were determined through calibration with available runoff data. Due to lack of runoff data from Wagonwheel, the fitted runoff parameters for Coto de Caza were used to model runoff from Wagonwheel Canyon. Also, model results for the post-development scenario do not include effects of the proposed modulation basin below the confluence of Wagonwheel and Gobernadora Creeks.

A total of 10 subcatchments were defined in the RMV project area. These subcatchments were disaggregated into valley and ridge subcatchments on the basis of topography. Different subcatchment areas and shapes were delineated for pre- and post-development areas because grading plans alter the topographic boundaries between drainage subcatchments. For post-development conditions, the subcatchments were further disaggregated on the basis of land-use. Table A-16 and Table A-17 lists the parameters of the modeled subcatchments for the pre- and post-development scenarios, respectively.

DRAFT

**Table A-16: Cañada Gobernadora – Pre-Development Subcatchment Parameters**

Sub-catchment		Area (acres)	Average Slope (ft/ft)	Percent Impervious	Hydraulic Conductivity (in/hr)	ET Scale Coefficient
Name	Land Use					
1-Valley	Open Space	5.6	0.160	0.0	1.8	0.40
1-Ridge	Open Space	302.0	0.290	0.0	1.0	0.53
2-Valley	Open Space	69.2	0.140	0.0	1.5	0.32
2-Ridge	Open Space	56.9	0.340	0.0	2.1	0.42
3-Valley	Open Space	131.3	0.060	0.3	1.3	0.14
3-Ridge	Open Space	227.7	0.310	24.2	1.5	0.39
4-Valley	Open Space	4.5	0.060	19.5	1.8	0.04
4-Ridge	Open Space	184.0	0.340	45.5	1.0	0.26
5-Valley	Open Space	49.6	0.080	0.9	1.7	0.43
5-Ridge	Open Space	285.4	0.310	9.7	1.7	0.49
6-Valley	Open Space	44.3	0.050	0.0	2.3	0.16
6-Ridge	Open Space	27.6	0.370	0.0	1.9	0.45
7-Valley	Open Space	57.9	0.030	0.0	1.0	0.20
7-Ridge	Open Space	89.9	0.240	0.0	0.9	0.57
8-Valley	Open Space	39.1	0.100	0.0	1.4	0.48
8-Ridge	Open Space	296.7	0.280	0.0	0.5	0.53
9-Valley	Open Space	17.8	0.100	0.0	1.0	0.46
9-Ridge	Open Space	136.7	0.330	26.1	1.2	0.39
10-Valley	Open Space	78.7	0.092	0.0	2.1	0.58
10-Ridge	Open Space	34.8	0.330	0.0	2.1	0.57
11- Wagonwheel	High K	965.8	0.17	21.4	1.96	0.29
11- Wagonwheel	Low K	67.8	0.17	2	0.03	0.29
11- Wagonwheel	Impervious	1.5	0.17	100	0.0	0.29
12- Coto de Caza	High K	3595.2	0.17	27	1.5	0.29
12- Coto de Caza	Low K	215.5	0.17	2	0.05	0.29
12- Coto de Caza	Impervious	63.1	0.17	100	0.0	0.29

DRAFT

**Table A-17: Cañada Gobernadora – Post-Development Subcatchment Parameters**

Sub-catchment		Area (acres)	Average Slope (ft/ft)	Percent Impervious	Hydraulic Conductivity (in/hr)	ET Scale Coefficient
Name	Land Use					
1-Valley	Open Space	4.8	0.16	0.0	1.7	0.42
1-Valley	SF Residential	0.8	0.16	40.0	2.1	0.35
1-Ridge	Open Space	32.6	0.29	0.0	0.8	0.50
1-Ridge	SF Residential	259.7	0.29	40.0	1.0	0.35
1-Ridge	Transportation	8.9	0.29	100.0	1.1	0.00
2-Valley	Open Space	68.9	0.14	0.1	1.5	0.32
2-Ridge	Open Space	56.5	0.34	0.0	2.1	0.42
2-Ridge	SF Residential	0.3	0.34	40.0	2.2	0.35
3-Valley	Open Space	84.4	0.06	0.0	1.0	0.13
3-Valley	SF Residential	43.2	0.06	40.0	2.0	0.35
3-Valley	Transportation	3.5	0.06	100.0	1.8	0.00
3-Ridge	Open Space	0.8	0.31	0.0	2.2	0.24
3-Ridge	SF Residential	211.8	0.31	40.0	1.5	0.35
3-Ridge	Transportation	15.5	0.31	100.0	2.0	0.00
4-Valley	Open Space	3.7	0.06	23.7	1.7	0.04
4-Valley	SF Residential	0.8	0.06	40.0	2.2	0.35
4-Ridge	Open Space	16.0	0.34	42.8	1.3	0.24
4-Ridge	SF Residential	163.8	0.34	40.0	1.0	0.35
4-Ridge	Transportation	4.2	0.34	100.0	1.2	0.00
5-Valley	Open Space	33.6	0.08	1.4	1.5	0.47
5-Valley	SF Residential	15.0	0.08	40.0	2.2	0.35
5-Valley	Transportation	1.4	0.08	100.0	2.1	0.00
5-Ridge	Open Space	94.5	0.31	9.2	1.9	0.53
5-Ridge	Estate	35.2	0.31	20.0	1.8	0.46
5-Ridge	SF Residential	148.1	0.31	40.0	1.6	0.35
5-Ridge	Transportation	7.6	0.31	100.0	1.4	0.00
6-Valley	Open Space	44.3	0.05	0.0	2.3	0.16
6-Ridge	Open Space	26.1	0.37	0.2	1.8	0.43
6-Ridge	Transportation	1.6	0.37	100.0	2.2	0.00
7-Valley	Open Space	51.6	0.03	0.0	1.0	0.18
7-Valley	Estate	3.2	0.03	20.0	2.1	0.46
7-Valley	Transportation	3.7	0.03	100.0	0.5	0.00
7-Ridge	Open Space	35.9	0.24	0.0	1.0	0.56
7-Ridge	Estate	53.2	0.24	20.0	0.8	0.46
7-Ridge	Transportation	0.7	0.24	100.0	2.3	0.00
8-Valley	Open Space	34.4	0.1	0.0	1.5	0.37
8-Valley	SF Residential	3.1	0.1	46.7	1.5	0.25
8-Valley	Transportation	2.5	0.1	100.0	0.6	0.00
8-Ridge	Open Space	174.1	0.28	0.0	0.6	0.49
8-Ridge	SF Residential	37.9	0.28	40.0	0.3	0.35
8-Ridge	Transportation	10.8	0.28	100.0	0.3	0.00
8-Ridge	Golf-Residential	32.9	0.28	20.0	0.1	0.46
9-Valley	Open Space	11.8	0.1	0.0	1.2	0.38
9-Valley	Estate	6.0	0.1	20.0	0.5	0.46
9-Ridge	Open Space	100.1	0.33	35.2	1.1	0.32
9-Ridge	Estate	36.5	0.33	20.0	1.3	0.46
10-Valley	Open Space	73.2	0.092	0.0	2.2	0.58
10-Valley	Estate	5.2	0.092	20.0	0.8	0.46
10-Ridge	Open Space	34.8	0.33	0.0	2.1	0.57
11- Wagonwheel	High K	965.8	0.17	21.4	1.96	0.29
11- Wagonwheel	Low K	67.8	0.17	2	0.03	0.29



DRAFT

Sub-catchment		Area (acres)	Average Slope (ft/ft)	Percent Impervious	Hydraulic Conductivity (in/hr)	ET Scale Coefficient
Name	Land Use					
11- Wagonwheel	Impervious	1.5	0.17	100	0.0	0.29
12- Coto de Caza	High K	3595.2	0.17	27	1.5	0.29
12- Coto de Caza	Low K	215.5	0.17	2	0.05	0.29
12- Coto de Caza	Impervious	63.1	0.17	100	0.0	0.29

**A-3.2.2 Cañada Gobernadora Model - Land-Use**

Pre- and post-development land-use in Cañada Gobernadora is shown in Figure A-10 and is tabulated in Table A-18. The modeled pre-development conditions are based on the PWA land-use maps. The existing land-use in the Gobernadora model is dominated by existing development areas in Upper Gobernadora (Coto de Caza) and Wagonwheel Canyon. The existing land-use in the RMV project area includes a mixture of agriculture and open space areas.

**Table A-18: Cañada Gobernadora – Pre- and Post- Development Land Use in the RMV Project Area (excludes Wagonwheel and Coto de Caza)**

PWA Code	Land-Cover	Pre-Development Scenario	Post-Development Scenario
20101, 20201, 20202, 20401	Agriculture & Orchard	621	233
20501	Nurseries	30	
10201-10306	Scrub & Chaparral	726	324
10401	Grassland	121	82
10501-10502, 10601	Woodland, Riparian, Forest, Meadow & Marsh	183	88
10701	Rock Outcrops	199	52
90101	General Disturbed Areas	258	203
30202	Single Family Residential		884
30203	Multi-Family Residential		
30202	Estate & Golf Residential		173
30401	Transportation		61
30501	Park	1	
	Undefined		24

The modeled development conditions were based on the B4 development alternative, the B4 principle roads plan, and the habitat restoration plan. These proposed development and habitat restoration plans were superimposed on the PWA land-use maps for existing conditions. The modeled post-development conditions are the amalgamation of these existing and proposed land-uses.

The proposed development includes single-family residential housing, and estates. The main arterial road in PA-2 and PA-3 (through catchments 3-8) was modeled as six-lane highway with an assumed impervious width of 120 feet. The smaller arterial roads (catchments 1/8 and 4/5)

were modeled with an impervious width of 56 feet. Proposed habitat restoration areas were incorporated into the SWMM model in terms of the effect on ET.

**A-3.2.3 Cañada Gobernadora Model - Subcatchment Soils**

The distribution of surficial soils in the Cañada Gobernadora model is shown in Figure A-11. Sandy loams are predominant throughout the canyon. In the lower half of the canyon, however, there are large areas of hardpan clays, clayey soils, and rock outcrops. Comparison of the land use coverage map (Figure A-10) and the soil texture map (Figure A-11) shows that much of the proposed residential and estates development is in terrains with hardpan clays, clayey soils, and rock outcrop.

**A-3.2.4 Cañada Gobernadora Model - Calibration**

The Gobernadora Canyon Model was calibrated to measured and estimated storm flow and dry-weather base flows.

The parameters of the upper Gobernadora catchment (Coto de Caza) were determined through calibration with continuous flow measurements collected at the bottom end of the Coto de Caza development (Wildermuth Environmental, 2003). The fitted model was able to replicate, quite well, the measured wet and dry weather runoff. Figure A-12 is a sample of the measured and modeled hydrographs for one of the monitored storm in February 2003.

Catchments in the lower Gobernadora drainage were calibrated to low flow measurements (Balance, 2001) and peak discharge estimates based on observations of high water marks (Balance, 2003b). Calibration results are presented in Table A-19 below.

**Table A-19: Cañada Gobernadora Model – Calibration Data and Calibration Results**

Flow Condition / Location	Date	Time	Measured or Estimated Discharge (cfs)	Predicted Discharge from SWMM (cfs)
<b>Low Flow</b>				
Gobernadora Crk below Coto de Caza	11/18/1999	9:40	0.2-0.3	1.0
	5/3/2000	17:00	0.5	0.55
Lower Gobernadora Creek	11/16/1999	16:00	1.8	1.45
	5/4/2000	9:00	0.25	1.63
<b>Peak Flow</b>				
Gobernadora Crk @ Lower Gauge	12/7/1997 or			
	2/23/1998	--	2214	2278
	2/21/2000	--	258	315
Gobernadora Creek above Sulfur	12/7/1997 or			
	2/23/1998	--	1457	1450
	2/21/2000	--	532	234

### **A-3.3 SWMM Model of the Central San Juan Sub-Basin**

#### **A-3.3.1 Central San Juan Model - Subcatchment Delineation**

The Central San Juan SWMM Model is defined by the catchments that drain to San Juan Creek, and catchments that are tributary to Trampas Creek, XX-Creek, and smaller tributaries of San Juan Creek in Planning Areas 3, 4, and 5.

The existing quarry area in the Trampas Sub-Basin was modeled in two ways under the pre-development scenario: 1) as open space under assumed pre-quarry conditions, and 2) under existing quarry conditions with the area divided into two regions – one with catchments that drain to Trampas Creek, and a second region in which catchments drain to a terminal reservoir. Water stored water is used re-circulated in conjunction with quarry operations.

Figure A-13 shows the catchments used to model pre- and post-development conditions in the Central San Juan Sub-Basin. The Sub-Basin was divided into 26 catchments under pre-development conditions, and 38 catchments under proposed post-development conditions. All catchments were disaggregated into valley and ridge subcatchments on the basis of topography, and on the basis of land-use. Table A-20 and Table A-21 lists the subcatchment properties for pre- and post-development conditions, respectively.

DRAFT

**Table A-20: Central San Juan Sub-Basin Model – Pre-Development Subcatchment Parameters**

Sub-catchment		Area (acres)	Average Slope (ft/ft)	Percent Impervious	Hydraulic Conductivity (in/hr)	ET Scale Coefficient
Name	Land Use					
13-Valley	Open Space	50.7	0.164	6.8	1.25	0.408
13-Ridge	Open Space	59.1	0.419	48.4	1.12	0.451
13-Ridge	Transportation	2.5	0.419	100.0	1.93	0.000
14-Valley	Open Space	30.4	0.078	2.6	1.81	0.659
14-Ridge	Open Space	59.0	0.367	29.7	1.19	0.377
14-Ridge	Transportation	2.6	0.367	100.0	1.28	0.000
15-Valley	Open Space	46.3	0.050	0.0	2.70	0.607
15-Ridge	Open Space	15.1	0.150	0.0	2.35	0.323
15-Ridge	Nursery	6.0	0.150	15.0	2.20	0.621
16-Valley	Open Space	25.8	0.071	0.0	2.90	0.900
16-Valley	Existing Dev	3.1	0.071	50.0	3.00	0.290
16-Ridge	Open Space	228.7	0.187	34.7	1.32	0.295
16-Ridge	Existing Dev	21.2	0.187	50.0	2.13	0.290
16-Valley	Park	4.9	0.071	15.0	3.00	0.621
16-Ridge	Nursery	96.5	0.187	15.0	2.17	0.621
17-Valley	Open Space	23.5	0.221	7.6	1.06	0.302
17-Ridge	Open Space	115.7	0.378	14.5	1.70	0.390
17-Ridge	Transportation	1.8	0.378	100.0	2.20	0.000
18-Ridge	Open Space	198.2	0.346	8.9	1.95	0.409
19-Valley	Open Space	23.4	0.103	0.0	2.20	0.678
19-Ridge	Open Space	25.1	0.387	0.0	2.20	0.451
19-Ridge	Transportation	4.1	0.387	100.0	2.20	0.000
20-Valley	Open Space	27.1	0.082	0.0	2.69	0.732
20-Valley	Existing Dev	4.3	0.082	48.0	3.00	0.302
20-Valley	Park	13.7	0.820	15.0	2.99	0.621
21-Valley	Open Space	41.8	0.051	0.0	2.73	0.481
21-Valley	Existing Dev	7.0	0.051	50.0	2.64	0.290
21-Ridge	Open Space	9.7	0.091	0.0	2.33	0.425
21-Ridge	Existing Dev	0.3	0.091	50.0	2.20	0.290
21-Valley	Park	3.9	0.051	15.0	2.40	0.621
21-Ridge	Nursery	25.3	0.091	15.0	2.20	0.621
22-Valley	Open Space	9.1	0.108	0.0	1.46	0.390
22-Valley	Transportation	0.5	0.108	100.0	1.90	0.000
22-Ridge	Open Space	118.6	0.302	0.0	1.96	0.489
22-Ridge	Transportation	0.8	0.302	100.0	2.20	0.000
23-Pre Quarry	Open Space	370.9	0.269	12.6	1.72	0.470
25-Pre Quarry	Open Space	559.3	0.320	1.9	1.69	0.430
23-Ridge	Open Space	319.2	0.269	15.6	1.67	0.518
23-Ridge	Existing Dev	19.4	0.269	50.0	1.54	0.290
24-Valley	Open Space	55.1	0.087	0.0	1.92	0.562
24-Valley	Transportation	3.5	0.087	100.0	0.80	0.000
24-Ridge	Open Space	257.7	0.320	0.1	1.93	0.494
24-Ridge	Transportation	4.0	0.320	100.0	2.07	0.000
25-Ridge	Open Space	199.6	0.320	0.0	1.94	0.454
26-Valley	Open Space	71.2	0.057	0.1	2.62	0.594
26-Valley	Existing Dev	10.7	0.057	49.0	2.91	0.296
26-Ridge	Open Space	214.7	0.221	12.6	1.95	0.299
26-Ridge	Existing Dev	0.6	0.221	47.4	2.45	0.305
26-Ridge	Nursery	24.3	0.221	15.0	2.20	0.621
27-Ridge	Open Space	244.5	0.031	39.4	1.21	0.250
28-Valley	Open Space	28.3	0.084	3.1	2.20	0.39

DRAFT

Sub-catchment		Area (acres)	Average Slope (ft/ft)	Percent Impervious	Hydraulic Conductivity (in/hr)	ET Scale Coefficient
Name	Land Use					
28-Valley	Existing Dev	21.9	0.084	50.0	2.51	0.29
28-Ridge	Open Space	126.7	0.190	0.3	2.19	0.31
28-Ridge	Existing Dev	1.2	0.190	50.0	2.31	0.29
29-Valley	Open Space	22.7	0.092	1.1	2.20	0.43
29-Valley	Existing Dev	3.2	0.092	50.0	2.35	0.29
30-Valley	Open Space	13.6	0.140	0.7	2.29	0.68
30-Valley	Transportation	0.7	0.140	100.0	2.20	0.00
30-Ridge	Open Space	5.0	0.259	0.0	2.20	0.39
30-Ridge	Transportation	0.5	0.259	100.0	2.20	0.00
31-Valley	Open Space	8.9	0.088	0.0	2.81	0.33
31-Valley	Transportation	1.2	0.088	100.0	2.69	0.00
31-Ridge	Open Space	265.4	0.418	17.7	1.32	0.31
31-Ridge	Transportation	0.9	0.418	100.0	2.37	0.00
32-Valley	Open Space	63.1	0.067	0.5	2.39	0.51
32-Valley	Transportation	4.0	0.067	86.5	2.52	0.08
32-Ridge	Open Space	155.5	0.566	25.0	1.62	0.29
32-Ridge	Transportation	0.9	0.566	100.0	2.22	0.00
33-Valley	Open Space	61.9	0.070	0.7	2.21	0.40
33-Valley	Existing Dev	4.5	0.070	69.5	2.27	0.18
33-Ridge	Open Space	33.5	0.096	0.0	2.20	0.50
34-Valley	Open Space	20.1	0.071	5.5	2.19	0.33
34-Valley	Transportation	1.9	0.071	100.0	2.46	0.00
34-Valley	Parks	8.3	0.071	15.0	2.60	0.62
34-Ridge	Open Space	108.9	0.513	46.5	1.18	0.26
35-Ridge	Open Space	248.4	0.565	56.0	0.97	0.20
36-Valley	Open Space	30.0	0.069	0.0	2.31	0.85
36-Valley	Transportation	3.6	0.069	100.0	2.20	0.00
36-Ridge	Open Space	89.6	0.244	0.2	2.20	0.38
37-Valley	Open Space	14.3	0.046	0.0	2.50	0.89
37-Ridge	Open Space	140.4	0.416	0.0	1.79	0.44
38-Valley	Open Space	53.2	0.066	0.0	2.46	0.82
38-Valley	Existing Dev	4.8	0.066	50.0	2.32	0.29
38-Valley	Transportation	3.7	0.066	100.0	2.46	0.00
36-Valley	Parks	35.7	0.069	15.0	2.54	0.62
38-Ridge	Nursery	15.0	0.066	15.0	2.59	0.62
38-Ridge	Open Space	75.5	0.316	12.9	1.92	0.41
23-Quarry	Quarry	38.2	0.269	14.8	2.19	0.01
25a-Quarry	Open Space	300.4	0.320	3.6	1.42	0.38
25a-Quarry	Quarry	26.3	0.320	15.0	2.12	0.00
23-Quarry	Water	4.0	0.269	100.0	0.00	1.00

DRAFT

**Table A-21: Central San Juan Sub-Basin Model – Post-Development Subcatchment Parameters**

Sub-catchment		Area (acres)	Average Slope (ft/ft)	Percent Impervious	Hydraulic Conductivity (in/hr)	ET Scale Coefficient
Name	Land Use					
13-Valley	Open Space	34.3	0.164	3.0	1.20	0.50
13-Valley	Residential	4.3	0.160	40.0	1.81	0.29
13-Ridge	Open Space	51.2	0.419	48.0	1.12	0.50
13-Ridge	Residential	7.6	0.419	40.0	1.14	0.29
13-Ridge	Transportation	2.9	0.419	100.0	1.93	0.00
14-Valley	Open Space	29.6	0.078	0.0	1.86	0.68
14-Ridge	Open Space	43.8	0.367	20.6	1.27	0.47
14-Ridge	Residential	12.2	0.367	40.0	0.76	0.29
14-Ridge	Transportation	2.6	0.367	100.0	1.28	0.00
15-Valley	Open Space	46.3	0.050	0.0	2.70	0.61
15-Ridge	Open Space	9.1	0.150	0.0	2.37	0.35
15-Ridge	Residential	1.3	0.150	40.0	2.30	0.29
16-Valley	Open Space	12.0	0.071	0.8	2.76	0.86
16-Valley	Residential	20.4	0.071	40.0	3.00	0.29
16-Valley	Transportation	1.4	0.071	100.0	2.97	0.00
16-Ridge	Open Space	2.9	0.187	0.0	2.79	0.37
16-Ridge	Residential	3.6	0.187	40.0	2.96	0.29
16-Ridge	Transportation	3.4	0.187	100.0	2.33	0.00
17-Valley	Open Space	7.3	0.221	0.0	2.21	0.54
17-Ridge	Open Space	28.0	0.378	3.4	2.12	0.49
17-Ridge	Residential	38.6	0.378	40.0	1.68	0.29
17-Ridge	Transportation	3.7	0.378	100.0	2.20	0.00
18a-Ridge	Open Space	8.1	0.346	0.0	2.20	0.45
18a-Ridge	Residential	3.5	0.346	40.0	2.20	0.29
18a-Ridge	Transportation	1.6	0.346	100.0	2.20	0.00
18b-Ridge	Open Space	6.1	0.346	0.0	2.20	0.36
18b-Ridge	Residential	0.7	0.346	40.0	2.20	0.29
19-Valley	Open Space	22.1	0.103	0.0	2.20	0.68
19-Valley	Transportation	1.3	0.103	100.0	2.20	0.00
19-Ridge	Open Space	24.6	0.387	0.0	2.20	0.45
19-Ridge	Transportation	4.5	0.387	100.0	2.20	0.00
20-Valley	Open Space	20.2	0.082	0.4	2.42	0.77
20-Valley	Residential	23.9	0.082	40.0	3.00	0.29
20-Valley	Transportation	1.0	0.082	100.0	2.26	0.00
21-Valley	Open Space	11.2	0.051	3.0	2.20	0.37
21-Valley	Residential	37.6	0.051	40.0	2.87	0.29
22-Valley	Open Space	9.1	0.108	0.0	1.46	0.39
22-Ridge	Open Space	56.2	0.302	0.0	1.97	0.67
22-Ridge	Residential	12.5	0.302	40.0	2.08	0.29
22-Ridge	Transportation	0.8	0.302	100.0	2.09	0.00
23-Ridge	Open Space	24.0	0.441	89.3	0.17	0.03
23-Ridge	Residential	19.2	0.441	40.0	1.77	0.29
24-Valley	Open Space	55.1	0.087	0.0	1.92	0.56
24-Valley	Transportation	3.5	0.087	100.0	0.80	0.00
24-Ridge	Open Space	257.7	0.320	0.1	1.93	0.49
24-Ridge	Transportation	4.0	0.320	100.0	2.07	0.00
25a-Ridge	Open Space	30.9	0.350	24.5	0.36	0.20
25a-Ridge	Residential	54.6	0.350	40.0	0.75	0.29
25b-Ridge	Open Space	97.4	0.384	0.0	2.07	0.42
25b-Ridge	Residential	3.3	0.384	40.0	2.14	0.29
25b-Ridge	Transportation	2.1	0.384	100.0	2.20	0.00

DRAFT

Sub-catchment		Area (acres)	Average Slope (ft/ft)	Percent Impervious	Hydraulic Conductivity (in/hr)	ET Scale Coefficient
Name	Land Use					
26-Valley	Open Space	16.1	0.057	0.2	2.20	0.54
26-Valley	Residential	46.0	0.057	40.0	2.78	0.29
27-Ridge	Open Space	75.7	0.031	42.9	1.20	0.23
27-Ridge	Residential	6.6	0.031	40.0	1.47	0.29
28-Valley	Open Space	3.9	0.068	0.6	2.20	0.54
28-Valley	Residential	5.0	0.068	40.0	2.20	0.29
29-Valley	Open Space	22.5	0.096	0.2	2.20	0.51
29-Valley	Residential	0.6	0.096	40.0	2.20	0.29
30-Valley	Open Space	13.6	0.140	0.0	2.28	0.73
30-Valley	Transportation	1.2	0.140	100.0	2.30	0.00
30-Ridge	Open Space	5.0	0.259	0.0	2.20	0.39
31-Valley	Open Space	8.9	0.088	0.0	2.81	0.33
31-Valley	Transportation	1.2	0.088	100.0	2.69	0.00
31-Ridge	Open Space	260.4	0.418	18.1	1.30	0.32
31-Ridge	Transportation	0.9	0.418	100.0	2.37	0.00
32-Valley	Open Space	19.3	0.067	0.0	2.21	0.56
32-Valley	Estates	42.9	0.067	20.0	2.50	0.46
32-Valley	Transportation	4.5	0.067	100.0	2.30	0.00
32-Ridge	Open Space	144.8	0.566	26.9	1.57	0.29
32-Ridge	Estates	10.7	0.566	20.0	2.23	0.46
32-Ridge	Transportation	0.9	0.070	100.0	2.22	0.00
33-Valley	Open Space	29.1	0.070	0.4	2.20	0.61
33-Valley	Residential	7.3	0.070	40.0	2.20	0.29
33-Valley	Estates	1.7	0.070	20.0	2.25	0.46
33-Valley	Transportation	1.0	0.070	100.0	2.20	0.00
33-Ridge	Residential	2.5	0.096	40.0	2.20	0.29
34-Valley	Open Space	0.7	0.071	0.0	2.20	0.24
34-Valley	Estates	27.6	0.071	20.0	2.30	0.46
34-Valley	Transportation	0.6	0.071	100.0	2.36	0.00
34-Ridge	Open Space	55.7	0.513	53.2	1.03	0.20
34-Ridge	Estates	53.1	0.513	20.0	1.33	0.46
35-Ridge	Open Space	248.4	0.565	56.0	0.97	0.20
36-Valley	Open Space	22.9	0.069	0.1	2.20	0.85
36-Valley	Estates	42.3	0.069	20.0	2.55	0.46
36-Valley	Transportation	3.5	0.069	100.0	2.45	0.00
36-Ridge	Open Space	24.5	0.244	0.0	2.20	0.53
36-Ridge	Residential	14.2	0.244	40.0	2.20	0.29
36-Ridge	Estates	1.2	0.244	20.0	2.20	0.46
36-Ridge	Transportation	1.1	0.244	100.0	2.20	0.00
37-Valley	Open Space	14.3	0.046	0.0	2.50	0.89
37-Ridge	Open Space	60.3	0.416	0.0	1.74	0.45
37-Ridge	Residential	11.4	0.416	40.0	1.89	0.29
38-Valley	Open Space	44.7	0.066	4.3	2.35	0.75
38-Valley	Estates	27.2	0.066	20.0	2.68	0.46
38-Valley	Transportation	5.7	0.066	100.0	2.59	0.00
38-Ridge	Open Space	67.7	0.316	14.4	1.88	0.41
38-Ridge	Estates	7.1	0.316	20.0	2.20	0.46
38-Ridge	Transportation	0.8	0.316	100.0	2.20	0.00
PA3-1	Residential	22.7	0.090	40.0	2.23	0.29
PA3-1	Transportation	2.3	0.090	100.0	2.33	0.00
PA3-2	Residential	8.7	0.078	40.0	2.76	0.29
PA3-2	Residential	175.5	0.078	40.0	2.23	0.29
PA3-2	Transportation	4.8	0.078	100.0	2.06	0.00

DRAFT

Sub-catchment		Area (acres)	Average Slope (ft/ft)	Percent Impervious	Hydraulic Conductivity (in/hr)	ET Scale Coefficient
Name	Land Use					
PA3-3	Residential	66.8	0.126	40.0	2.44	0.29
PA3-3	Residential	69.4	0.126	40.0	2.26	0.29
PA3-3	Transportation	3.6	0.126	100.0	2.24	0.00
PA3-4	Residential	19.7	0.075	40.0	2.20	0.29
PA3-4	Residential	65.1	0.075	40.0	2.20	0.29
PA3-4	Transportation	0.2	0.075	100.0	2.20	0.00
PA3-5	Residential	345.9	0.098	40.0	1.67	0.29
PA3-5	Transportation	4.6	0.098	100.0	1.72	0.00
PA3-6	Residential	140.2	0.052	40.0	1.61	0.29
PA3-6	Transportation	3.0	0.052	100.0	1.20	0.00
PA3-7	Residential	134.7	0.064	40.0	1.09	0.29
PA3-7	Transportation	3.1	0.064	100.0	1.82	0.00
PA3-8	Transportation	1.9	0.072	100.0	2.16	0.00
PA3-8	Residential	108.1	0.072	40.0	1.36	0.29
PA5-1	Open Space	3.5	0.156	0.0	2.20	0.33
PA5-1	Residential	85.9	0.156	40.0	2.08	0.29
PA5-1	Transportation	2.9	0.156	100.0	2.20	0.00
PA5-2	Residential	43.0	0.209	40.0	0.56	0.29
PA5-2	Open Space	24.5	0.209	10.0	0.33	0.39
PA5-2	Residential	196.6	0.209	40.0	1.42	0.29
PA5-2	Transportation	1.6	0.209	100.0	2.20	0.00
PA5-3	Residential	195.9	0.080	40.0	1.92	0.29
PA5-3	Transportation	6.5	0.080	100.0	2.03	0.00
PA5-4	Open Space	49.7	0.175	0.7	1.25	0.40
PA5-4	Residential	487.8	0.175	40.0	1.80	0.29
PA5-4	Transportation	6.7	0.175	100.0	1.30	0.00

**A-3.3.2 Central San Juan Sub-Basin Model - Land-Use**

Pre- and post-development land-use in Central San Juan Sub-Basin is shown in Figure A-14 and is tabulated in Table A-22. The modeled pre-development conditions are based on the PWA land-use maps. The existing land-use in the Gobernadora model is dominated by existing development areas in Upper Gobernadora (Coto de Caza) and Wagonwheel Canyon. The existing land-use in the RMV project area includes a mixture of agriculture and open space areas.



**Table A-22: Central San Juan Sub-Basin Model – Pre- and Post- Development Land Use**

<b>PWA Code</b>	<b>Land-Cover</b>	<b>Pre-Development Scenario – (Pre Quarry)</b>	<b>Pre-Development Scenario – (With Quarry)</b>	<b>Post-Development Scenario</b>
20101, 20201, 20202, 20401	Agriculture & Orchard	129	129	17
20501	Nurseries	167	167	
10201-10306	Scrub & Chaparral	1873	1799	985
10401	Grassland	929	881	250
10501-10502, 10601	Woodland, Riparian, Forest, Meadow & Marsh	737	692	405
10701	Rock Outcrops	648	635	360
30101	General Development	82	101	2497
30202	Estate			214
30401	Transportation	38	38	95
30501	Park	68	68	4
	Undefined	127	252	71
	Water		37	

The modeled development conditions were based on the B4 development alternative, the B4 principle roads plan, and the habitat restoration plan. These proposed development and habitat restoration plans were superimposed on the PWA land-use maps for existing conditions. The modeled post-development conditions are the amalgamation of these existing and proposed land-uses.

The proposed development includes single-family residential housing, and estates. The main arterial road in PA-2 and PA-3 (through catchments 3-8) was modeled as six-lane highway with an assumed impervious width of 120 feet. The smaller arterial roads (catchments 1/8 and 4/5) were modeled with an impervious width of 56 feet. Proposed habitat restoration areas were incorporated into the SWMM model in terms of the effect on ET.

**A-3.3.3 Central San Juan Sub-Basin Model - Subcatchment Soils**

The distribution of surficial soils in the Central San Juan Sub-Basin model is shown in Figure A-14. Sandy loams occur in much of the Sub-Basin. There are large areas of hardpan clays, clayey soils, and rock outcrops in northern and eastern portions of the Sub-Basin, coinciding with much of the proposed development area in PA-3 (Figure A-13).

**A-3.3.4 Central San Juan Sub-Basin Model – Calibration**

Low flow measurements (Balance, 2001) and peak discharge estimates based on observations of high water marks (Balance, 2003b) are available only for the tributary to San Juan Creek, east of Color Spot. The Central San Juan Sub-Basin Model was not calibrated. Rather, it was assumed that the calibrated parameters from the Gobernadora Sub-Basin Model were applicable for the in the Central San Juan Sub-Basin.

**A-3.4 Cristianitos Sub-Basin – SWMM Simulation Parameters**

**A-3.4.1 Cristianitos Sub-Basin Model - Subcatchment Delineation**

The Cristianitos Sub-Basin SWMM Model is defined by the catchment area that is directly tributary to Cristianitos Creek, upstream of the confluence with Gabino Creek. Development areas in the Cristianitos Sub-Basin include PA-6, and a large portion of PA-7. However, due to habitat sensitivity of Cristianitos Creek, a majority of the runoff from the proposed development areas in PA-7 would be directed to the Gabino Sub-Basin. As a result the total watershed area would be reduced from 2370 in the pre-development setting to 2190 acres under proposed post-development conditions.

The entire Cristianitos Sub-Basin was modeled for pre-development conditions to facilitate model calibration with measured and estimated flows. The Cristianitos Sub-Basin was divided into 25 catchments under pre-development conditions (Figure A-15).

For post-development conditions, the subcatchments in development areas were delineated on the basis of grading plans and drainage objectives. A total of 31 catchments were defined for post-development conditions (Figure A-15).

Both pre- and post-development subcatchments were disaggregated into valley and ridge subcatchments, as well as, subcatchments based on land-use designation. Table A-23 and Table A-24 lists the parameters of the modeled subcatchments for the pre- and post-development scenarios, respectively.

**Table A-23: Cristianitos Model – Pre-Development Subcatchment Parameters**

Sub-catchment		Area (acres)	Average Slope (ft/ft)	Percent Impervious	Hydraulic Conductivity (in/hr)	ET Scale Coefficient
Name	Land Use					
39-Valley	Open Space	38.7	0.136	0.0	1.7	0.320
39-Valley	Transportation	1.6	0.136	100.0	1.7	0.000
39-Ridge	Open Space	2.8	0.208	0.0	1.2	0.284
40-Valley	Open Space	9.3	0.145	0.0	1.5	0.520
40-Ridge	Open Space	8.7	0.290	0.0	1.7	0.295
41-Valley	Open Space	31.7	0.157	0.0	1.3	0.778
41-Ridge	Open Space	170.3	0.402	0.0	1.8	0.489
42-Valley	Open Space	71.3	0.154	0.0	1.8	0.682
42-Ridge	Open Space	303.6	0.298	0.0	1.8	0.499
43-Valley	Open Space	17.7	0.162	0.0	0.9	0.355
43-Valley	Transportation	0.6	0.162	100.0	0.9	0.000
43-Ridge	Open Space	21.8	0.307	0.0	1.4	0.339
43-Ridge	Quarry	15.4	0.307	30.0	1.4	0.020
44-Valley	Open Space	5.3	0.140	0.0	1.0	0.282
44-Valley	Quarry	0.3	0.140	30.0	1.0	0.020
44-Ridge	Open Space	16.8	0.227	0.0	1.5	0.205
44-Ridge	Quarry	15.6	0.227	30.0	1.5	0.020
45-Valley	Open Space	13.4	0.169	0.0	1.7	0.339
46-Valley	Open Space	7.3	0.172	0.0	0.8	0.453
46-Valley	Transportation	1.1	0.172	100.0	0.8	0.000

DRAFT

Sub-catchment		Area (acres)	Average Slope (ft/ft)	Percent Impervious	Hydraulic Conductivity (in/hr)	ET Scale Coefficient
Name	Land Use					
46-Ridge	Open Space	15.4	0.421	0.0	1.7	0.466
47-Valley	Open Space	13.4	0.131	0.0	1.6	0.268
47-Valley	Quarry	1.1	0.131	30.0	1.6	0.020
47-Ridge	Open Space	23.6	0.235	0.0	1.7	0.251
47-Ridge	Quarry	11.3	0.235	30.0	1.7	0.020
48-Valley	Open Space	14.0	0.135	0.0	0.9	0.323
48-Valley	Quarry	0.9	0.135	30.0	0.9	0.020
48-Valley	Transportation	1.2	0.135	100.0	0.9	0.000
48-Ridge	Open Space	10.1	0.236	0.0	0.2	0.291
48-Ridge	Quarry	6.3	0.236	30.0	0.2	0.020
49-Valley	Open Space	6.8	0.158	0.0	0.9	0.359
49-Valley	Transportation	0.6	0.158	100.0	0.9	0.000
49-Ridge	Open Space	22.7	0.388	0.0	1.8	0.460
50-Valley	Open Space	29.3	0.157	0.0	1.6	0.816
50-Valley	Transportation	0.1	0.157	100.0	1.6	0.000
50-Ridge	Open Space	223.0	0.296	0.0	1.6	0.552
51-Valley	Open Space	41.6	0.138	0.0	0.4	0.296
51-Valley	Transportation	1.8	0.138	100.0	0.4	0.000
51-Valley	Quarry	2.1	0.138	30.0	0.4	0.020
51-Ridge	Open Space	84.6	0.286	0.0	0.0	0.280
52-Valley	Open Space	19.9	0.149	0.0	1.4	0.459
52-Valley	Transportation	1.0	0.149	100.0	1.4	0.000
52-Ridge	Open Space	8.8	0.312	0.0	1.6	0.342
53-Valley	Open Space	22.8	0.179	0.0	1.7	0.560
53-Ridge	Open Space	72.4	0.305	0.0	1.7	0.440
54-Valley	Open Space	17.2	0.158	0.0	1.4	0.292
54-Valley	Transportation	0.2	0.158	100.0	1.4	0.000
54-Ridge	Open Space	131.3	0.362	0.0	0.1	0.328
55-Valley	Open Space	48.9	0.108	0.0	1.4	0.283
55-Ridge	Open Space	44.6	0.292	0.0	0.8	0.300
56-Valley	Open Space	35.7	0.188	0.0	1.6	0.355
56-Valley	Transportation	0.3	0.188	100.0	1.6	0.000
56-Valley	Existing Dev	10.1	0.188	50.0	1.6	0.290
56-Ridge	Open Space	0.0	0.071	0.0	1.8	0.311
57-Valley	Open Space	71.9	0.141	0.0	1.3	0.297
57-Ridge	Open Space	61.0	0.260	0.0	0.4	0.300
58-Valley	Open Space	6.9	0.134	0.0	0.9	0.406
58-Ridge	Open Space	240.2	0.383	0.0	0.1	0.469
59-Valley	Open Space	15.3	0.129	0.0	1.2	0.285
59-Ridge	Open Space	39.7	0.340	0.0	1.8	0.448
60-Valley	Open Space	31.3	0.167	0.0	1.5	0.335
60-Valley	Transportation	2.0	0.167	100.0	1.5	0.000
60-Valley	Existing Dev	26.2	0.167	50.0	1.5	0.290
60-Ridge	Open Space	15.4	0.255	0.0	1.8	0.480
61-Valley	Open Space	19.2	0.137	0.0	1.5	0.390
61-Valley	Transportation	0.6	0.137	100.0	1.5	0.000
61-Valley	Existing Dev	0.5	0.137	50.0	1.5	0.290
61-Ridge	Open Space	48.6	0.246	0.0	1.8	0.359
62-Valley	Open Space	6.5	0.120	0.0	1.8	0.324
62-Ridge	Open Space	41.0	0.271	0.0	1.8	0.462
63-Valley	Open Space	45.1	0.156	0.0	1.6	0.278
63-Valley	Transportation	1.4	0.156	100.0	1.6	0.000
63-Ridge	Open Space	21.4	0.300	0.0	1.7	0.384

DRAFT

**Table A-24: Cristianitos Model – Post-Development Subcatchment Parameters**

Sub-catchment		Area (acres)	Average Slope (ft/ft)	Percent Impervious	Hydraulic Conductivity (in/hr)	ET Scale Coefficient
Name	Land Use					
39-Valley	Open Space	38.59	0.136	7.7	1.66	0.323
39-Ridge	Open Space	1.04	0.208	0.3	1.80	0.251
40-Valley	Open Space	9.32	0.145	4.5	1.49	0.520
40-Ridge	Open Space	8.73	0.290	0.0	1.69	0.295
41-Valley	Open Space	31.71	0.157	0.0	1.26	0.778
41-Ridge	Open Space	170.32	0.402	0.0	1.76	0.489
42-Valley	Open Space	71.26	0.154	0.0	1.75	0.682
42-Ridge	Open Space	303.6	0.298	0.0	1.78	0.500
43-Valley	Open Space	9.15	0.162	10.4	0.75	0.389
44-Valley	Open Space	2.92	0.140	4.7	1.05	0.311
44-Ridge	Open Space	2.20	0.227	0.0	1.12	0.311
45-Valley	Open Space	11.12	0.169	1.9	1.70	0.357
46-Valley	Open Space	8.33	0.172	10.6	0.78	0.453
46-Ridge	Open Space	15.37	0.421	0.0	1.69	0.466
47-Valley	Open Space	5.54	0.131	0.0	1.79	0.303
48-Valley	Open Space	9.11	0.135	2.5	0.97	0.361
48-Ridge	Open Space	2.72	0.236	0.0	0.59	0.349
49-Valley	Open Space	7.44	0.158	12.0	0.92	0.359
49-Ridge	Open Space	22.72	0.388	0.0	1.79	0.460
50-Valley	Open Space	29.41	0.157	0.1	1.64	0.816
50-Ridge	Open Space	223.0	0.296	0.0	1.59	0.553
51-Valley	Open Space	12.58	0.138	7.4	0.38	0.383
52-Valley	Open Space	18.00	0.149	6.2	1.34	0.489
52-Ridge	Open Space	8.77	0.312	0.0	1.59	0.342
53-Valley	Open Space	22.83	0.179	0.0	1.72	0.560
53-Ridge	Open Space	72.42	0.305	0.0	1.69	0.440
54-Valley	Open Space	13.65	0.169	6.3	1.62	0.338
54-Valley	Residential	4.16	0.169	40.0	1.37	0.348
54-Ridge	Residential	4.20	0.169	40.0	0.32	0.348
55-Valley	Open Space	5.97	0.107	0.0	1.80	0.254
55-Valley	Residential	15.24	0.107	40.0	1.40	0.348
55-Valley	Transportation	1.15	0.107	100.0	1.80	0.000
55-Valley	Golf Course	5.75	0.107	10.0	1.80	0.657
55-Ridge	Residential	4.14	0.107	40.0	1.41	0.348
57-Valley	Open Space	16.50	0.141	0.0	0.24	0.250
57-Ridge	Open Space	51.27	0.260	0.0	0.10	0.292
58-Valley	Open Space	4.11	0.134	0.0	0.51	0.347
58-Valley	Residential	1.93	0.134	40.0	1.65	0.348
58-Ridge	Open Space	223.45	0.383	0.0	0.07	0.480
58-Ridge	Residential	8.37	0.383	40.0	0.004	0.348
59-Valley	Open Space	29.51	0.129	1.2	0.97	0.363
59-Ridge	Open Space	39.66	0.340	0.0	1.78	0.448
61-Valley	Open Space	11.24	0.137	0.0	1.26	0.315
61-Ridge	Open Space	41.66	0.246	0.0	1.80	0.461
63-Valley	Open Space	22.23	0.156	0.0	1.37	0.283
63-Ridge	Open Space	20.30	0.300	0.0	1.67	0.389
63-Valley	Transportation	1.12	0.300	100.0	1.80	0.000
PA6-1	Golf Course	38.62	0.162	10.0	1.57	0.657
PA6-1	Transportation	1.86	0.162	100.0	0.92	0.000
PA6-2	Open Space	8.16	0.103	0.0	1.80	0.376
PA6-2	Golf Course	57.57	0.103	10.0	1.75	0.657
PA6-2	Transportation	7.03	0.103	100.0	1.72	0.000

DRAFT

Sub-catchment		Area (acres)	Average Slope (ft/ft)	Percent Impervious	Hydraulic Conductivity (in/hr)	ET Scale Coefficient
Name	Land Use					
PA6-2	Residential	23.76	0.103	40.0	1.78	0.348
PA6-3	Open Space	2.67	0.352	0.0	1.79	0.334
PA6-3	Transportation	3.53	0.352	100.0	1.66	0.000
PA6-3	Residential	22.41	0.352	40.0	1.74	0.348
PA6-4	Open Space	17.31	0.229	0.0	1.77	0.408
PA6-4	Golf Course	95.65	0.229	10.0	1.72	0.657
PA6-4	Residential	2.62	0.229	40.0	1.80	0.348
PA7-9	Open Space	4.20	0.136	0.0	1.29	0.256
PA7-9	Residential	46.57	0.136	40.0	1.12	0.348
PA7-9	Transportation	4.75	0.136	100.0	1.04	0.000
PA7-10	Open Space	2.47	0.129	0.0	0.56	0.250
PA7-10	Residential	64.24	0.129	40.0	1.07	0.348
PA7-10	Transportation	4.15	0.129	100.0	1.29	0.000
PA7-11	Open Space	1.27	0.149	0.0	1.80	0.263
PA7-11	Residential	67.74	0.149	40.0	0.33	0.348
PA7-11	Transportation	8.83	0.149	100.0	0.12	0.000
PA7-14	Residential	28.26	0.185	40.0	0.85	0.348
PA7-14	Transportation	2.14	0.185	100.0	1.22	0.000
PA7-16	Residential	31.34	0.355	40.0	0.44	0.348

**A-3.4.2 Cristianitos Sub-Basin Model - Land-Use**

Pre- and post-development land-use in Cristianitos Sub-Basin is shown in Figure A-15 and is tabulated in Table A-25. The modeled pre-development conditions are based on the PWA land-use maps. There is little existing development in the pre-development conditions. Clay pit quarries are present in the southeastern portion of the watershed.

**Table A-25: Cristianitos Sub-Basin Model – Pre- and Post- Development Land Use**

PWA Code	Land-Cover	Pre-Development Scenario	Post-Development Scenario
10201-10306	Scrub & Chaparral	960	805
10401	Grassland	980	483
10501-10502, 10601	Woodland, Riparian, Forest, Meadow & Marsh	328	304
90101	General Disturbed Areas (roads, residential, quarry)	93	49
30202	Single Family Residential		326
30401	Transportation		49
30501	Golf Course		198

The modeled development conditions were based on the B4 development alternative, the B4 principle roads plan, and the habitat restoration plan. These proposed development and habitat restoration plans were superimposed on the PWA land-use maps for existing conditions. The modeled post-development conditions are the amalgamation of these existing and proposed land-uses.

The proposed development includes single-family residential housing in PA-6 and PA-7, and a golf course in PA-7. The main arterial road in the B4 principle roads plan crosses through PA-6 and the upper section of PA-7. The road was modeled as six-lane highway with an assumed impervious width of 120 feet. Proposed habitat restoration areas in Upper Cristianitos were incorporated into the SWMM model in terms of the effect on ET.

**A-3.4.3 Cristianitos Sub-Basin Model - Subcatchment Soils**

The distribution of surficial soils in the Cristianitos Sub-Basin is shown in Figure A-16. Surficial deposits of sandy loams are dominant throughout the watershed, however, many areas are underlain by clayey deposits at shallow depths. Surficial deposits of clayey soils are dominant in the northern and eastern portions of the watershed. Comparison of the land use coverage map (Figure A-15) and the soil texture map (Figure A-16) shows that much of the proposed residential in PA-7 is located in areas with clayey soils.

**A-3.4.4 Cristianitos Sub-Basin Model – Calibration**

The Cristianitos Sub-Basin Model for pre-development conditions was to low flow measurements (Balance, 2001) and peak discharge estimates based on observations of high water marks (Balance, 2003b). Calibration results are presented in Table A-26 below.

**Table A-26: Cristianitos Sub-Basin Model - Calibration Data and Calibration Results**

Flow Condition / Location	Date	Time	Measured or Estimated Discharge (cfs)	Predicted Discharge using SWMM (cfs)
<b>Low Flow</b>				
Upper Cristianitos Canyon	11/17/1999	7:00	Dry	0.003
Cristianitos Crk upstream of Gabino	11/17/1999	8:00	Dry	0.001
<b>Peak Discharge</b>				
Cristianitos Crk upstream of Gabino	12/7/1997 or 2/23/1998	--	296	76 on 12/7/1997 345 on 2/23/98

**A-3.5 Gabino Sub-Basin Model**

**A-3.5.1 Gabino Sub-Basin Model - Subcatchment Delineation**

The Gabino Sub-Basin SWMM Model is defined by the catchment area that is directly tributary to Gabino Creek, excluding La Paz Canyon and Blind Canyon. Development areas in the Gabino Sub-Basin include PA-9, a portion of PA-7, and a small section of PA-8C.

The entire Gabino Sub-Basin was modeled for pre-development conditions to facilitate model calibration with measured and estimated flows above the confluence with La Paz Canyon. The Gabino Sub-Basin was divided into 37 catchments under pre-development conditions (Figure A-17).

DRAFT

A water balance evaluation for post-development conditions was conducted for development areas in PA-7 and PA-8, however, the analysis for PA-9 was handled qualitatively. Thus, only catchments that drain to Lower Gabino Canyon were modeled in the post-development scenario. These catchments are the numbers catchments 68-80 and development catchments in PA-7 and PA-8 (see Figure A-17). The development areas were delineated on the basis of grading plans and drainage objectives. A total of 24 catchments were defined for post-development conditions.

Both pre- and post-development subcatchments were disaggregated into valley and ridge subcatchments, as well as, subcatchments based on land-use designation. Table A-27 and Table A-28 lists the parameters of the modeled subcatchments for the pre- and post-development scenarios, respectively.

**Table A-27: Gabino Sub-Basin Model – Pre-Development Subcatchment Parameters**

Sub-catchment		Area (acres)	Average Slope (ft/ft)	Percent Impervious	Hydraulic Conductivity (in/hr)	ET Scale Coefficient
Name	Land Use					
68-Valley	Open Space	83.8	0.091	4.3	2.68	0.63
68-Ridge	Open Space	74.5	0.240	3.0	1.80	0.29
69-Valley	Open Space	15.8	0.132	31.9	2.09	0.20
69-Ridge	Open Space	256.7	0.243	5.1	0.75	0.27
69-Ridge	Existing Dev	11.2	0.125	50.0	0.04	0.29
70-Valley	Open Space	33.3	0.101	4.2	2.84	0.73
70-Ridge	Open Space	66.3	0.306	2.3	0.33	0.35
70-Ridge	Existing Dev	0.1	0.798	50.0	0.03	0.29
71-Valley	Open Space	2.9	0.059	0.0	4.72	1.03
71-Ridge	Open Space	58.6	0.423	0.0	0.04	0.44
72-Valley	Open Space	27.3	0.121	0.0	2.24	0.94
72-Valley	Existing Dev	3.6	0.097	50.0	1.89	0.29
72-Ridge	Open Space	51.6	0.353	0.0	0.40	0.42
72-Ridge	Existing Dev	6.3	0.270	50.0	1.59	0.29
73-Valley	Open Space	0.3	0.084	0.0	3.88	1.10
73-Ridge	Open Space	55.2	0.421	0.2	0.13	0.36
73-Ridge	Existing Dev	0.7	0.250	50.0	0.11	0.29
74-Valley	Open Space	21.8	0.092	0.0	1.94	0.68
74-Ridge	Open Space	114.3	0.382	1.6	1.03	0.47
74-Ridge	Existing Dev	2.0	0.151	50.0	0.01	0.29
75-Valley	Open Space	0.0	0.401	0.0	2.92	0.40
75-Ridge	Open Space	39.2	0.427	0.0	1.48	0.57
76-Ridge	Open Space	113.9	0.344	0.4	1.29	0.37
76-Ridge	Existing Dev	7.1	0.225	50.0	0.40	0.29
77-Ridge	Open Space	316.4	0.402	0.0	1.61	0.42
78-Valley	Open Space	30.1	0.094	0.0	1.38	0.66
78-Ridge	Open Space	62.1	0.350	0.0	1.63	0.50
79-Valley	Open Space	4.2	0.165	0.0	2.05	1.08
79-Ridge	Open Space	57.9	0.419	0.0	1.79	0.45
80-Valley	Open Space	20.8	0.129	0.0	2.48	0.65
80-Ridge	Open Space	27.6	0.485	0.0	1.49	0.52
81-Valley	Open Space	3.9	0.191	0.0	3.13	0.74
81-Ridge	Open Space	360.0	0.418	0.0	1.81	0.41
82-Valley	Open Space	25.4	0.162	0.0	2.86	0.86
82-Ridge	Open Space	39.9	0.478	0.0	1.36	0.46
83-Valley	Open Space	30.0	0.142	0.0	3.49	0.89

DRAFT

Sub-catchment		Area (acres)	Average Slope (ft/ft)	Percent Impervious	Hydraulic Conductivity (in/hr)	ET Scale Coefficient
Name	Land Use					
83-Ridge	Open Space	363.1	0.402	0.0	1.60	0.46
84-Valley	Open Space	35.6	0.154	0.0	2.93	0.90
84-Ridge	Open Space	89.9	0.418	0.0	1.75	0.42
85-Valley	Open Space	2.3	0.153	0.0	2.14	0.93
85-Ridge	Open Space	198.6	0.325	0.0	1.66	0.42
86-Valley	Open Space	16.9	0.153	0.0	3.23	0.88
86-Ridge	Open Space	20.5	0.440	0.0	1.65	0.40
87-Valley	Open Space	0.4	0.346	0.0	4.26	0.65
87-Ridge	Open Space	236.8	0.331	0.0	1.78	0.41
88-Valley	Open Space	53.3	0.194	0.0	1.38	0.57
88-Ridge	Open Space	76.4	0.406	0.0	0.89	0.40
89-Valley	Open Space	6.9	0.215	0.0	0.32	0.35
89-Ridge	Open Space	54.4	0.396	0.0	0.12	0.43
90-Valley	Open Space	5.3	0.126	0.0	2.41	0.54
90-Ridge	Open Space	48.9	0.373	0.0	1.63	0.45
91-Valley	Open Space	7.7	0.148	0.0	0.63	0.29
91-Ridge	Open Space	128.6	0.288	0.0	0.73	0.37
92-Valley	Open Space	4.3	0.137	0.0	2.85	0.48
92-Ridge	Open Space	61.2	0.313	0.0	0.11	0.31
93-Valley	Open Space	23.5	0.167	0.0	1.74	0.46
93-Ridge	Open Space	7.3	0.258	0.0	0.28	0.30
94-Valley	Open Space	2.2	0.120	0.0	3.51	0.33
94-Ridge	Open Space	132.3	0.225	0.0	0.90	0.32
94-Ridge	Existing Dev	0.1	0.225	50.0	0.08	0.29
95-Valley	Open Space	30.0	0.109	0.0	3.15	0.55
95-Ridge	Open Space	41.8	0.239	0.0	0.95	0.33
96-Valley	Open Space	6.9	0.172	0.0	3.40	0.64
96-Ridge	Open Space	38.5	0.223	0.0	0.72	0.40
97-Valley	Open Space	7.3	0.111	0.0	2.45	0.34
97-Ridge	Open Space	122.6	0.267	0.0	0.73	0.30
98-Valley	Open Space	1.9	0.332	0.0	1.97	0.40
98-Ridge	Open Space	74.4	0.276	0.0	0.81	0.40
99-Valley	Open Space	8.9	0.308	0.0	2.36	0.65
99-Ridge	Open Space	16.3	0.389	0.0	1.45	0.36
100-Valley	Open Space	4.6	0.316	0.0	2.89	0.87
100-Ridge	Open Space	106.8	0.307	0.0	0.98	0.35
101-Valley	Open Space	15.6	0.133	0.0	3.53	0.45
101-Ridge	Open Space	37.4	0.188	0.0	1.82	0.38
102-Valley	Open Space	27.1	0.149	0.0	1.28	0.36
102-Ridge	Open Space	123.7	0.267	0.0	0.82	0.37
103-Ridge	Open Space	127.4	0.376	0.0	1.96	0.40
104-Ridge	Open Space	213.5	0.356	0.4	1.90	0.40



DRAFT

**Table A-28: Gabino Sub-Basin Model – Post-Development Subcatchment Parameters**

Sub-catchment		Area (acres)	Average Slope (ft/ft)	Percent Impervious	Hydraulic Conductivity (in/hr)	ET Scale Coefficient
Name	Land Use					
68-Ridge	Open Space	31.4	0.240	2.6	1.81	0.32
68-Valley	Open Space	75.9	0.091	3.7	2.73	0.67
68-Valley	Transportation	2.4	0.091	100.0	3.06	0.00
69-Ridge	Open Space	11.1	0.243	30.4	2.29	0.27
69-Valley	Open Space	6.7	0.132	24.5	2.91	0.50
70-Ridge	Open Space	20.5	0.306	1.3	0.56	0.51
70-Valley	Open Space	30.9	0.101	4.4	2.97	0.77
71-Ridge	Open Space	34.7	0.423	0.0	0.06	0.53
71-Valley	Open Space	2.9	0.059	0.0	4.72	1.03
72-Ridge	Open Space	47.2	0.353	0.0	0.56	0.42
72-Ridge	Estate	8.8	0.353	20.0	0.59	0.46
72-Valley	Open Space	30.9	0.121	0.0	2.20	0.86
73-Ridge	Open Space	44.2	0.421	0.3	0.14	0.38
73-Ridge	Estate	16.3	0.421	20.0	0.16	0.46
74-Ridge	Open Space	102.5	0.382	1.4	1.05	0.49
74-Ridge	Existing Dev	0.4	0.151	50.0	0.03	0.29
74-Ridge	Estate	12.1	0.382	20.0	0.81	0.46
74-Valley	Open Space	21.8	0.092	0.0	1.94	0.68
75-Ridge	Open Space	37.6	0.427	0.0	1.47	0.58
75-Ridge	Estate	1.6	0.427	20.0	1.80	0.46
76-Ridge	Open Space	74.0	0.344	0.7	1.64	0.41
76-Ridge	Existing Dev	2.8	0.225	50.0	0.29	0.29
76-Ridge	Estate	47.7	0.344	20.0	0.64	0.46
77-Ridge	Open Space	288.0	0.402	0.0	1.65	0.43
77-Ridge	Estate	24.9	0.402	20.0	1.28	0.46
78-Ridge	Open Space	62.1	0.350	0.0	1.63	0.50
78-Valley	Open Space	30.1	0.094	0.0	1.38	0.66
79-Ridge	Open Space	57.9	0.419	0.0	1.79	0.45
79-Valley	Open Space	4.2	0.165	0.0	2.05	1.08
80-Ridge	Open Space	27.6	0.485	0.0	1.49	0.52
80-Valley	Open Space	20.8	0.129	0.0	2.48	0.65
PA7-1	Open Space	6.9	0.314	22.4	3.00	0.21
PA7-1	Residential	1.8	0.314	40.0	3.08	0.35
PA7-1	Transportation	3.6	0.314	100.0	3.01	0.00
PA7-2	Open Space	6.0	0.132	0.9	22.80	0.27
PA7-2	Estate	3.6	0.132	20.0	23.99	0.46
PA7-2	Residential	85.7	0.132	40.0	9.51	0.35
PA7-3	Residential	65.1	0.075	40.0	5.87	0.35
PA7-3	Transportation	1.2	0.075	100.0	11.96	0.00
PA7-4	Open Space	5.0	0.139	0.0	20.96	0.26
PA7-4	Estate	1.0	0.139	20.0	24.00	0.46
PA7-4	Residential	29.0	0.139	40.0	21.06	0.35
PA7-5	Residential	53.3	0.125	40.0	18.48	0.35
PA7-6	Open Space	15.1	0.088	10.8	20.82	0.27
PA7-6	Estate	7.6	0.088	20.0	16.81	0.46
PA7-6	Residential	50.6	0.088	40.0	22.98	0.35
PA7-7	Open Space	9.1	0.148	1.3	20.16	0.27
PA7-7	Estate	3.2	0.148	20.0	14.60	0.46
PA7-7	Residential	9.2	0.148	40.0	18.43	0.35
PA7-12	Residential	27.7	0.133	40.0	15.66	0.35
PA7-12	Transportation	0.2	0.133	100.0	23.93	0.00
PA7-13	Open Space	1.9	0.167	0.0	24.00	0.25

DRAFT

Sub-catchment		Area (acres)	Average Slope (ft/ft)	Percent Impervious	Hydraulic Conductivity (in/hr)	ET Scale Coefficient
Name	Land Use					
PA7-13	Residential	36.7	0.167	40.0	18.56	0.35
PA7-15	Open Space	12.0	0.185	0.0	23.45	0.27
PA7-15	Estate	1.3	0.185	20.0	24.00	0.46
PA7-15	Residential	66.9	0.185	40.0	16.84	0.35
PA6-12	Golf Course	20.3	0.128	10.0	0.33	0.66
PA6-14	Open Space	6.0	0.317	0.0	0.01	0.36
PA6-14	Golf Course	29.7	0.317	10.0	0.01	0.66

**A-3.5.2 Gabino Sub-Basin Model - Land-Use**

Pre- and post-development land-use in Gabino Sub-Basin is shown in Figure A-18 and is tabulated in Table A-29 for the Lower Gabino catchments. Note that the area of the Lower Gabino Watershed increases from pre- to post-development because runoff from some development areas in the Cristianitos Watershed are routed to Gabino Creek.

**Table A-29: Gabino Sub-Basin Model – Pre- and Post- Development Land Use**

PWA Code	Land-Cover	Pre-Development Scenario (Catchments 68-80)	Post-Development Scenario (Catchments 68-80; PA7-1-7, 13, 15; PA-6 12,14)
10201-10306	Scrub & Chaparral	707	586
10401	Grassland	525	277
10501-10502, 10601	Woodland, Riparian, Forest, Meadow & Marsh	229	224
90101	General Disturbed Areas (roads, existing dev, quarry)	105	42
30202	Single Family Residential		426
30202	Estate		128
30401	Transportation		7
30501	Golf Course		50

The modeled pre-development conditions are based on the PWA land-use maps. The vast of majority of the Lower Gabino Watershed is undeveloped open space, with some small pockets of existing development.

The modeled development conditions were based on the B4 development alternative, the B4 principle roads plan, and the habitat restoration plan. These proposed development and habitat restoration plans were superimposed on the PWA land-use maps for existing conditions. The modeled post-development conditions are the amalgamation of these existing and proposed land-uses.

The proposed development includes single-family residential and estate housing in PA-7, and a portion of the proposed golf course in PA-8C. The main arterial road in the B4 principle roads plan is aligned north to south near the western boundary of the watershed. The road was modeled as six-lane highway with an assumed impervious width of 120 feet.

**A-3.5.3 Gabino Sub-Basin Model - Subcatchment Soils**

The distribution of surficial soils in the Gabino Sub-Basin is shown in Figure A-18. Surficial deposits of sandy loams are dominant throughout the watershed, however, there are large area of clayey soils in the upper and lower portions of the watershed. Comparison of the land use coverage map (Figure A-17) and the soil texture map (Figure A-18) shows that much of the proposed residential in the Gabino Sub-basin is located in areas with clayey soils.

**A-3.5.4 Gabino Sub-Basin Model – Calibration**

The Gabino Sub-Basin Model for pre-development conditions was to low flow measurements (Balance, 2001) and peak discharge estimates based on observations of high water marks (Balance, 2003b). Calibration results are presented in Table A-26 below.

**Table A-30: Gabino Sub-Basin Model - Calibration Data and Calibration Results**

Flow Condition / Location	Date	Time	Measured or Estimated Discharge (cfs)	Predicted Discharge using SWMM (cfs)
<b><u>Low Flow</u></b>				
Gabino Creek above La Paz	11/17/1999	11:00	Dry	0.0
	5/4/2000	15:30	Dry	0.01
<b><u>Peak Discharge</u></b>				
Gabino Creek above La Paz	12/7/1997 or			
	2/23/1998	--	786	795 on 2/23/98
	2/21/2000	--	20	29

**A-3.6 Blind Canyon and Talega Canyons Model**

**A-3.6.1 Blind Canyon and Talega Model - Subcatchment Delineation**

Proposed development in PA-8 is primarily situated within Blind Canyon, with some development proposed along the ridge between Blind and Talega Canyons. Blind Canyon is a 700-acre watershed that is tributary to Gabino Creek. Talega Canyon is a large watershed with the majority of the drainage outside of the RMV boundary. Only a small portion of the proposed development in PA-8 drains towards Talega Canyon, and under post-development conditions, most of the runoff from the development area would be directed to Gabino. For these reasons, the Blind Canyon and Talega Model encompasses all areas tributary to Blind Canyon Creek and only proposed development areas in Talega Canyon.

For the pre-development scenario, 4 catchments are defined in Blind Canyon, and 6 catchments are defined in Talega Canyon (Figure A-19). For post-development conditions, 7 catchments are

DRAFT

defined in PA-8A and 8B, 3 catchments are defined in PA8-C, and 3 catchments are defined in open space areas in Blind Canyon (see Figure A-19). All catchments would drain to Gabino Creek, with the exception that some runoff from development areas in Talega Canyon would be routed to Talega Creek to maintain pre-development hydrology.

Both pre- and post-development subcatchments were disaggregated into valley and ridge subcatchments, as well as, subcatchments based on land-use designation. Table A-31 and Table A-32 lists the parameters of the modeled subcatchments for the pre- and post-development scenarios, respectively.

**Table A-31: Blind Canyon and Talega Model – Pre-Development Subcatchment Parameters**

Sub-catchment		Area (acres)	Average Slope (ft/ft)	Percent Impervious	Hydraulic Conductivity (in/hr)	ET Scale Coefficient
Name	Land Use					
64-Valley	Open Space	93.5	0.161	0.0	1.59	0.58
64-Ridge	Open Space	212.4	0.323	0.0	1.05	0.47
64-Ridge	TRW	30.6	0.403	90.0	1.63	0.06
65-Valley	Open Space	2.7	0.193	0.0	0.30	0.28
65-Ridge	Open Space	120.0	0.329	0.0	0.59	0.38
66-Valley	Open Space	11.6	0.142	0.0	2.93	0.43
66-Ridge	Open Space	197.9	0.339	0.0	1.06	0.43
66-Ridge	Existing Dev	0.5	0.183	50.0	1.79	0.29
67-Valley	Open Space	10.1	0.156	0.0	0.23	0.28
67-Ridge	Open Space	53.8	0.273	0.0	0.03	0.30
PA8-3	Open Space	78.3	0.336	0.0	1.80	0.30
PA8-3	TRW	0.1	0.336	90.0	1.80	0.06
PA8-4	Open Space	103.5	0.605	0.0	1.80	0.35
PA8-4	TRW	9.0	0.605	90.0	1.80	0.06
PA8-5	Open Space	80.3	0.526	0.0	1.25	0.33
PA8-5	TRW	21.0	0.526	90.0	1.53	0.06
PA8-6	Open Space	129.0	0.759	0.0	1.23	0.34
PA8-6	TRW	3.7	0.759	90.0	1.60	0.06
PA8-7	Open Space	31.2	0.827	0.0	1.37	0.37
PA8-8	Open Space	15.1	0.603	0.0	1.00	0.34
PA8-9a	Open Space	0.4	0.209	0.0	0.15	0.32
PA8-9b	Open Space	1.6	0.463	0.0	0.74	0.36

**Table A-32: Blind Canyon and Talega Model – Post-Development Subcatchment Parameters**

Sub-catchment		Area (acres)	Average Slope (ft/ft)	Percent Impervious	Hydraulic Conductivity (in/hr)	ET Scale Coefficient
Name	Land Use					
64-Ridge	Open Space	64.5	0.323	0.0	1.21	0.62
64-Ridge	Golf Course	5.0	0.323	10.0	0.38	0.66
64-Ridge	Transportation	2.1	0.323	100.0	1.80	0.00
64-Ridge	Residential	36.4	0.323	40.0	1.42	0.35
64-Valley	Open Space	36.7	0.161	0.0	2.16	0.74
64-Valley	Golf Course	1.5	0.161	10.0	1.33	0.66
64-Valley	Transportation	1.2	0.161	100.0	3.52	0.00
65-Ridge	Open Space	43.6	0.329	0.0	0.07	0.48
65-Ridge	Golf Course	0.8	0.329	10.0	0.01	0.66
65-Ridge	Estate	5.6	0.329	20.0	0.50	0.46
65-Valley	Open Space	1.6	0.193	0.0	0.27	0.28
66-Ridge	Open Space	181.1	0.339	0.0	1.16	0.44
66-Valley	Open Space	9.5	0.142	0.0	3.28	0.42
PA8-3	Open Space	0.8	0.336	0.0	1.80	0.55
PA8-3	Residential	102.6	0.336	40.0	1.80	0.35
PA8-3	Transportation	5.8	0.336	100.0	1.80	0.00
PA8-4	Residential	123.3	0.605	40.0	1.80	0.35
PA8-4	Transportation	5.6	0.605	100.0	1.80	0.00
PA8-5	Residential	137.0	0.526	40.0	1.32	0.35
PA8-6	Open Space	2.0	0.759	0.0	1.27	0.33
PA8-6	Residential	130.6	0.759	40.0	1.23	0.35
PA8-6	Estate	13.0	0.759	20.0	0.14	0.46
PA8-7	Estate	33.5	0.827	20.0	1.36	0.46
PA8-8	Estate	18.7	0.603	20.0	0.80	0.46
PA8-9	Open Space	4.2	0.173	0.0	0.60	0.33
PA8-9	Estate	60.5	0.173	20.0	1.00	0.46
PA8-10	Open Space	4.9	0.095	0.0	1.06	0.26
PA8-10	Residential	72.8	0.095	40.0	0.91	0.35
PA8-10	Golf Course	58.0	0.095	10.0	1.34	0.66
PA8-10	Transportation	1.8	0.095	100.0	1.80	0.00
PA8-11	SFR	4.1	0.111	40.0	0.27	0.35
PA8-11	Golf Course	73.8	0.111	10.0	0.72	0.66
PA8-13	Golf Course	10.8	0.181	10.0	0.13	0.66
PA8-13	Golf Resort	13.8	0.181	65.0	0.23	0.20

**A-3.6.2 Blind Canyon and Talega Model - Land-Use**

Pre- and post-development land-use in Blind and Talega Canyons is shown in Figure A-19 and is tabulated in Table A-33.

The modeled pre-development conditions are based on the PWA land-use maps. Commercial development (TRW) is present along the ridge between Blind and Talega Canyon. The remaining modeled area is primarily open space.

The modeled development conditions were based on the B4 development alternative, the B4 principle roads plan, and the habitat restoration plan. These proposed development and habitat

DRAFT

restoration plans were superimposed on the PWA land-use maps for existing conditions. The modeled post-development conditions are the amalgamation of these existing and proposed land-uses (see Figure A-19).

The proposed development includes single-family residential and estate housing, a golf course and a golf resort. The main arterial road in the B4 principle roads plan is aligned north to south near the western edge of the modeled area. The road was modeled as six-lane highway with an assumed impervious width of 120 feet.

**Table A-33: Blind Canyon and Talega Model – Pre- and Post- Development Land Use**

<b>PWA Code</b>	<b>Land-Cover</b>	<b>Pre-Development Scenario – Drainage to Blind Canyon (Catchments 64-67)</b>	<b>Pre-Development Scenario – Drainage to Talega Canyon (Catchments PA8 – 3-8, 9a, 9b)</b>	<b>Post-Development Scenario (Catchments 64-66; PA8 – 3-11, 13)</b>
10201-10306	Scrub & Chaparral	261	241	166
10401	Grassland	329	197	109
10501-10502, 10601	Woodland, Riparian, Forest, Meadow & Marsh	113	1	74
	Existing Development – TRW	31	34	
30202	Single Family Residential			606
30202	Estate			132
30401	Transportation			16
30501	Golf Course			150
30203	Golf Resort			14

**A-3.6.3 Blind Canyon and Talega Model - Subcatchment Soils**

The distribution of surficial soils in Blind Canyon and the Talega development area is shown in Figure A-20. Surficial deposits of sandy loams are dominant throughout the area, however, there are large regions of clayey soils in the middle portions of the Blind Canyon, extending south into Talega Canyon. Similar to other areas in RMV, comparison of the land use coverage map (Figure A-19) and the soil texture map (Figure A-20) shows that major portions of the proposed residential development are located in areas with clayey soils.

**A-3.6.4 Blind Canyon and Talega Model – Calibration**

Low flow measurements (Balance, 2001) and peak discharge estimates based on observations of high water marks (Balance, 2003b) were not collected or estimated in the Blind and Talega Canyons. Thus, data similar to that used to calibrate the SWMM models for other sub-basins in RMV were not available for the Blind Canyon and Talega Model. Therefore, it was assumed that the calibrated parameters from the Gabino Sub-Basin Model were applicable for the Blind Canyon and Talega Model.

**A-3.7 Verdugo Canyon Model**

**A-3.7.1 Verdugo Canyon - Subcatchment Delineation**

Proposed development in PA-4 within the Verdugo Sub-Basin was modeled only for the B9 Alternative. Impacts from the B4 Alternative were qualitatively evaluated and are discussed in Section 5.8.

Modeling of the Verdugo Sub-Basin was limited to the proposed development areas in the lower portion of the Canyon. For the pre-development scenario, 6 catchments are defined in Verdugo Canyon (Figure A-21), while 10 catchments were modeled in for the post-development conditions.

Both pre- and post-development subcatchments were disaggregated into valley and ridge subcatchments, as well as, subcatchments based on land-use designation. Table A-34 and Table A-35 lists the parameters of the modeled subcatchments for the pre- and post-development scenarios, respectively.

**Table A-34: Verdugo Sub-Basin Model – Pre-Development Subcatchment Parameters**

Sub-catchment		Area (acres)	Average Slope (ft/ft)	Percent Impervious	Hydraulic Conductivity (in/hr)	ET Scale Coefficient
Name	Land Use					
120-Valley	Open Space	34.20	0.98	0.0	2.97	0.61
120-Ridge	Open Space	74.28	0.86	0.0	2.20	0.42
121-Ridge	Open Space	428.16	0.29	9.9	1.91	0.40
122-Ridge	Open Space	218.58	1.01	0.0	1.86	0.43
123-Valley	Open Space	40.09	0.99	0.0	2.32	0.58
123-Ridge	Open Space	231.86	0.41	0.0	2.20	0.40
124-Valley	Open Space	11.41	0.95	0.0	2.99	0.52
124-Ridge	Open Space	146.45	0.29	0.0	1.31	0.50
125-Valley	Open Space	41.58	1.35	0.0	2.96	0.66
125-Ridge	Open Space	287.49	0.72	0.0	1.76	0.44

**Table A-35: Verdugo Sub-Basin Model – Post-Development Subcatchment Parameters**

Sub-catchment		Area (acres)	Average Slope (ft/ft)	Percent Impervious	Hydraulic Conductivity (in/hr)	ET Scale Coefficient
Name	Land Use					
120-Valley	Open Space	34.2	0.98	0	2.97	0.61
120-Ridge	Open Space	73.1	0.86	0	2.20	0.42
120-Ridge	Residential	0.0	0.86	40	2.20	0.35
120-Ridge	Transportation	0.7	0.86	100	2.20	0.00
121a-Ridge	Open Space	17.9	1.02	0	1.88	0.40
121a-Ridge	Residential	17.5	1.02	40	1.72	0.35
121b-Ridge	Open Space	60.7	0.98	0	2.05	0.34
121b-Ridge	Residential	49.7	0.98	40	2.07	0.35

DRAFT

Sub-catchment		Area (acres)	Average Slope (ft/ft)	Percent Impervious	Hydraulic Conductivity (in/hr)	ET Scale Coefficient
Name	Land Use					
121c-Ridge	Open Space	18.5	0.84	0	2.20	0.55
121c-Ridge	Residential	0.9	0.84	40	2.20	0.35
121c-Ridge	Transportation	1.2	0.84	100	2.20	0.00
122-Ridge	Open Space	70.5	1.15	0	1.98	0.39
122-Ridge	Residential	19.5	1.15	40	1.90	0.35
123-Valley	Open Space	39.8	0.99	0	2.31	0.58
123-Ridge	Open Space	231.9	0.41	0	2.20	0.40
124-Valley	Open Space	11.4	0.95	0	2.99	0.52
124-Ridge	Open Space	146.4	0.29	0	1.31	0.50
125-Valley	Open Space	41.6	1.35	0	2.96	0.66
125-Ridge	Open Space	287.5	0.72	0	1.76	0.44
PA4-4	Open Space	61.9	0.91	15	1.88	0.42
PA4-4	Residential	146.5	0.91	40	1.59	0.35
PA4-4	Transportation	6.5	0.91	100	2.10	0.00
PA4-5	Residential	236.2	0.93	40	1.97	0.35
PA4-5	Transportation	1.9	0.93	100	2.20	0.00

**A-3.7.2 Verdugo Sub-Basin Model - Land-Use**

Pre- and post-development land-use in Verdugo Sub-Basin Model is shown in Figure A-21 and is tabulated in Table A-36.

**Table A-36: Verdugo Sub-Basin Model – Pre- and Post- Development Land Use**

PWA Code	Land-Cover	Pre- Development Scenario	Post- Development Scenario
10201-10306	Scrub & Chaparral	1203	878
10401	Grassland	126	99
10501-10502, 10601	Woodland, Riparian, Forest, Meadow & Marsh	142	108
10701	Rock Outcrops	43	8
30202	Single Family Residential		470
30401	Transportation		10

**A-3.7.3 Verdugo Sub-Basin Model - Subcatchment Soils**

The distribution of surficial soils in Blind Canyon and the Talega development area is shown in Figure A-22. Surficial deposits of sandy loams are dominant throughout the area, however, there are large regions of clayey soils in catchments 122 and 124.



#### **A-3.7.4 Verdugo Sub-Basin Model – Calibration**

Available calibration data in the Verdugo Sub-Basin were upstream of the modeled catchments. Therefore, no calibration was conducted for the Verdugo Sub-Basin Model. Model parameters are based on the calibrated model from the Gobernadora Sub-Basin.

### **A-4 MONTHLY WATER BALANCE**

The SWMM hydrologic simulation model was used to develop a monthly water balance for the modeled Sub-Basins. To enable assessment of potential impacts from proposed development, water balances were developed for three scenarios:

1. Pre-development conditions
2. Post-development conditions without BMPs
3. Post-development conditions with BMPs

The water balances of the first two scenarios were developed directly from output of the continuous hydrologic simulations using SWMM. Water balances of the third scenario were determined through subsequent analyses. The proposed BMPs were not modeled with SWMM. Rather, separate analyses were conducted to quantify the hydrologic effects of proposed BMPs, and to incorporate these effects into the water balance. All water balance results are presented in Appendix D.

#### **A-4.1 Water Balance Calculation Procedure**

The SWMM hydrologic simulation model was adapted to provide the following monthly output for each modeled subcatchment:

- Accumulated volume of precipitation
- Accumulated volume of irrigation
- Accumulated volume of surface flows from the catchment
- Accumulated volume of ET losses from the surface and subsurface
- Accumulated volume of surface flows from the catchment
- Accumulated volume of groundwater flows from the catchment

For each of the modeled catchments, the SWMM model generates 53-years of accumulated monthly output. The results can then be summed, on a monthly basis, for all catchments in the Sub-Basin, or if desired, for a subset of catchments in the Sub-Basin. The water-balance results for the first two scenarios are then simply the monthly average of the accumulated monthly

output over the Sub-Basin. Monthly averages were calculated for complete 53-record, and for the dry and wet periods.

#### **A-4.2 BMP Sizing and Inclusion in the Monthly Water Balance**

BMPs were not modeled directly with SWMM, and therefore separate analyses were required to incorporate the hydrologic effects of BMPs into the water balance. The following describes the methods used to size various BMPs and the approach used to incorporate the hydrologic effects from these BMPs into the water balance.

##### **A-4.2.1 Detention Basin – Sizing and Inclusion in Water Balance**

Water quality detention basins were sized with the Water Environment Federation (WEF) standard method and criteria for sizing water quality (WQ) facilities for treatment of stormwater. Detention basins for WQ treatment were designed to capture 80 percent of the total runoff volume that achieves 80 percent reduction in pollutant loads, resulting in an overall pollutant load reduction of about 64 percent.

Following the sizing of the WQ basin, a separate analysis was used to incorporate the hydrologic effects of the WQ basin into the water balance. The main hydrologic effects of the WQ Basins are to alter the timing of surface discharges, and to increase ET. Infiltration occurring in the WQ basin was not incorporated into the water balance.

Output hydrographs generated from SWMM were routed through the WQ basins. These output hydrographs represent the predicted runoff (on a continuous basis) generated from the proposed development areas. Results from this routing analysis provides the inflows to the WQ Basin, the treated outflows routed to the stream, the untreated bypass flows routed to the stream, and ET losses, each expressed as accumulated monthly volumes over the 53-year simulation period. These monthly results were then incorporated into the water balance by appropriately modifying the monthly surface runoff and total ET.

##### **A-4.2.2 Flow Duration Basin – Sizing and Inclusion in Water Balance**

Hydrologic source control BMPs were sized to match pre- and post- development flow duration curves. With flow duration (FD) matching, 60% to 80% of the total runoff volume is captured and infiltrated, thus achieving 60% to 80% overall load reduction. Flow duration matching was designed to maintain the pre-development runoff volume as well as the distribution of hourly flows. For example, if 1000 hours of 50 cfs flows occur under pre-urban conditions, than about 1000 hours of 50 cfs flows must be maintained to match flow duration. This criterion is applied to the full range of flows under pre-developed conditions from near zero to the 10-peak flow.

The size of the FD/WQ basin was determined through an iterative process of adjusting basin storage and selecting and adjusting orifice sizes in the outlet structure until pre- and post-development flow duration curves were similar within an acceptable range. The basin was

initially sized to capture the increase in runoff volume that is generated from the impervious surfaces. This capture volume is not arbitrary, but depends on the development characteristics and the soil types, and the magnitude of change in runoff created by the proposed development.

Once the lower portion of the basin was sized to capture the correct volume of runoff, the upper portion of the basin was established to detain and discharge larger flows through a specific set of orifice holes in such a way to reproduce the flow duration curve. The number, diameter and elevation of these orifice holes are determined by trial and error and by experience. The combination of sizing the lower portion of the FD/WQ basin and the upper portion to detain and discharge high flows has the affect of capturing the correct volume of runoff and matching the pre-urban distribution of hourly flows.

Similar to the WQ Basin, a separate analysis was used to incorporate the hydrologic effects of the FD/WQ basin into the water balance. The main hydrologic effects of the FD/WQ Basins are to reduce and alter the timing of surface discharges, and to increase ET. Infiltration occurring in the FD/WQ basin was not incorporated into the water balance.

Output hydrographs generated from SWMM were routed through the FD/WQ basins. Results from this routing analysis provides the inflows to the WD/WQ Basin, the treated outflows that are routed to the infiltration basin, the bypass flows routed to the stream, and ET losses, each expressed as accumulated monthly volumes over the 53-year simulation period. These monthly results were then incorporated into the water balance by appropriately modifying the monthly surface runoff and total ET.

#### **A-4.2.3 Infiltration Basin – Sizing and Inclusion in Water Balance**

The infiltration basins were sized to infiltrate the increase in the volume caused by the proposed development. The volume and surface area required for infiltration was determined through an iterative process using a spreadsheet model. The model requires the user to input the infiltration rate, evaporation rate and surface area of the infiltration basin as well as the time series discharged through the bottom orifice of the FD/WQ basin. An infiltration rate of 1 in/hr was used to approximate infiltration into sandy soils. The evaporation rate was approximated at 4 in/month to represent typical wintertime evaporation rates.

The size of the infiltration basin was determined by first specifying the area of the basin (assuming vertical sidewalls), then routing the times series output of the WQ/FD basin discharges through the infiltration basin. The basin volume is tracked for each time increment and the maximum volume that occurred within the time series is recorded. The required basin depth is then estimated by dividing the maximum volume by the area. The basin surface area is modified iteratively until a maximum basin depth of 2-ft is achieved. A maximum design depth of 2-ft was used to allow for the growth of emergent vegetation for improved water treatment.

Once the infiltration basin was sized, a separate analysis was used to incorporate the hydrologic effects of the infiltration basin into the water balance. The main hydrologic effects of the

infiltration basin are to increase infiltration into the subsurface, and to increase ET. The output hydrograph generated from the spreadsheet infiltration model was converted into accumulated monthly infiltration volumes. These monthly volumes were then added to the GW flows in the water balance, and subtracted from the surface runoff.

#### **A-4.2.4 Bioinfiltration Swale – Sizing and Inclusion in Water Balance Sizing**

The bioinfiltration swales were sized using the same concepts that were utilized in sizing the infiltration basins. One main difference is that the swales can be sized to discharge runoff to the receiving streams rather than infiltrating the entire flow. As with the infiltration basins, the user defines the infiltration rate, evaporation rate, and surface area. Evaporation rates and infiltration rates were approximated at 0.0055 in/hr and 1.0 in/hr, respectively. The user also defines the swale depth. Swales were assumed to have an overflow depth of 1-ft. Depths in excess of 1-ft would not allow adequate contact between the runoff and vegetation, thus reducing treatment efficiency.

Similar to the WQ Basin, a separate analysis was used to incorporate the hydrologic effects of the swales into the water balance. The main hydrologic effects of the swale are to increase infiltration into the subsurface, and to increase ET. Output from the swale sizing program are accumulated into monthly infiltration volumes, discharge volumes to the stream, and ET volumes. These monthly totals were then appropriately incorporated into the water balance.

#### **A-4.2.5 Storage of Non-Potable Water for Golf Course Irrigation**

A potential BMP for development areas adjacent to golf courses is to capture and store urban runoff as a source of non-potable water for golf course irrigation. The potential benefits of this concept include a reduction of runoff volumes typically associated with urban development and a reduction of water importation to meet irrigation demands. The storage facilities would additionally function as a wet pond for treatment of the stormwater, prior to use for irrigation. The main limitation is that runoff and peak irrigation demands are seasonally out of phase (runoff occurs in the wet season and peak irrigation demands are in the dry season). Larger storage volumes can mitigate this limitation, however, there is point at which increased costs of larger storage facilities negate the marginal increases in benefits.

An analysis of 53-years of monthly runoff volumes from development areas and monthly irrigation demands was conducted to determine the average annual volume of runoff that could be stored as a non-potable water supply. The runoff volumes were determined from the SWMM simulations and the monthly irrigation demands are given in Table A-9. Using an assumed storage capacity, a monthly routing procedure was used to determine storage volume, irrigation withdrawals, bypass volumes, and ending storage volume. Monthly averages were then determined over the total 53-year record, as well as, during the dry and wet periods. The analysis was repeated for a range of storage capacities. A plot of storage capacity versus average

## DRAFT

irrigation usage was then used to select a favorable storage volume, one that balances the maximum irrigation usage and minimum facility size. To insure that the water quality treatment requirements are met, the selected storage volume was compared to the sizing requirements for water quality treatment, as determined by WEF method described above.

### A-5 REFERENCES

Balance Hydrologics, Inc, September 2001. Groundwater Sustaining Landscape-Scale Wetland Function, San Juan and San Mateo Watersheds, Southern Orange County, California, Appendix C to the Baseline Geomorphic and Hydrologic Conditions Report.

Balance Hydrologics, Inc, 2003a. Memorandum, Chiquadora Ridge Perched Soils, from Scott Brown, Bonnie Mallory, and Barry Hecht to Laura Coley Eisenberg, August 7, 2003.

Balance Hydrologics, Inc, 2003b. Memorandum, RMV Peak Flows, from Scott Brown and Barry Hecht to Laura Coley Eisenberg, August 10, 2003.

CIMIS, 2003. California Irrigation Management Information System, [www.cimis.water.ca.gov](http://www.cimis.water.ca.gov)

County of Orange, October 1986. Orange County Hydrology Manual, Orange County, California Environmental Management Agency.

County of Orange, 2002. Hydrologic Data Report, 2001-2002 Season, Volume XXXVII, Public Facilities and Recourses Department.

Hamilton, D., 2000. The Response of the Muddy Canyon (Crystal Cove Area California) Watershed Water Balance to Multi-decadal Shifts in Climate/Rainfall Patterns and Development, Exponent, Inc., Costa Mesa, CA.

James, W., W.C. Huber, R. E. Pitt, R.E. Dickinson, W.R. James, 2002. Water Systems Models Hydrology, A guide to the Rain, Temperature, Runoff, Combine and Statistics modules of the USEPA SWMM4, Computational Hydraulics International, Guelph, Ontario, Canada.

Morton, P.K., 1974. Geology and engineering geologic aspects of the south half of the Canada Gobernadora quadrangle, Orange County, California: CDMG Special Report 111, 30 p.

Lacznia, R.J., J.L. Smith, P.E. Elliot, G.A. DeMeo, M.A. Chatigny, and G.J. Roemer, 2001. Ground-water discharge determined from estimates of evapotranspiration, Death Valley Regional Flow System, Nevada and California, USGS Water-Resources Investigations Report 01-4195, [water.usgs.gov/pubs/wri/wri014195/index.htm](http://water.usgs.gov/pubs/wri/wri014195/index.htm)

Lewis, D., M.J. Singer, R.A. Dahlgren, and K.W. Tate, 2000. Hydrology in a California oak woodland watershed: a 17-year study, Journal of Hydrology, 240:106-117.

## DRAFT

PWA, May 2001. Technical Appendix A, Baseline Hydrologic Conditions, San Juan & Upper San Mateo Watersheds, prepared by Philip Williams & Associates.

Rawls, W.J. and D.L. Brakensiek, 1989. Estimation of soil water retention and hydraulic properties, in *Unsaturated Flow in Hydrologic Modeling* (H.J Morel-Seytoux Ed), Kluwer Academic, Dordrecht.

RMV, February 2002. Final Report, Baseline Geomorphic and Hydrologic Conditions – RMV: Portions of the San Juan & Western San Mateo Watersheds, prepared by PCR Services, Philip Williams & Associates, and Balance Hydrologics.

RMV, July 2002. Watershed and Sub-Basin Planning Principles, prepared by Rancho Mission Viejo Consultant Team.

Santa Margarita Water District, 2003a. Preliminary Landscape Irrigation Water Usage Analysis 2001, prepared by Water Concern LTD.

Santa Margarita Water District, 2003b. Plan of Works for Improvement Districts 4C, 4E, 5 & 6, prepared by Tetra Tech.

Scott, R.L., W.J. Shuttleworth, D.C. Goodrich, and T. Maddock III, 2000. The water use of two dominant vegetation communities in a semiarid riparian ecosystem, *Agricultural and Forest Meteorology*, 105:241-256.

Steinwand, A.L., R.F. Harrington, and D.P. Groeneveld, 2001. Transpiration coefficients for three Great Basin Shrubs, *Journal of Arid Environments*, 49:555-567.

USDA, 1978. Soil Survey of Orange County and Western Part of Riverside County, California, US Dept of Agriculture, Soil Conservation Service and Forest Service in cooperation with the University of California Agricultural Experiment Station.

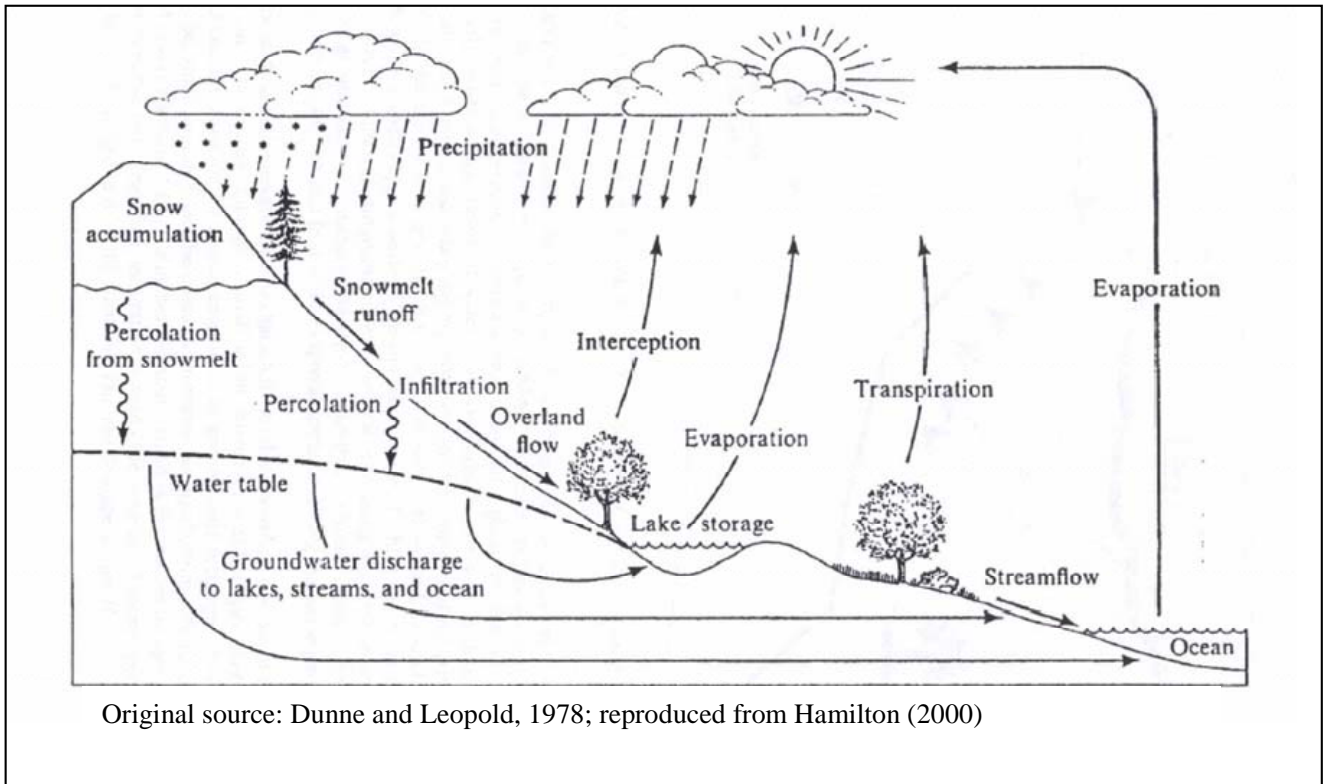
Wateright, 2003. [www.wateright.org/site2/reference/selectcrop.asp](http://www.wateright.org/site2/reference/selectcrop.asp)

Wever, L.A., L.B. Flanagan, and P.J. Carlson, 2002. Seasonal and interannual variation in evapotranspiration, energy balance and surface conductance in a northern temperate grassland, *Agricultural and Forest Meteorology* 112: 31-49.

Wight, J.R., C.L. Hanson, and K.R. Cooley, 1986. Modeling evapotranspiration from sagebrush-grass rangeland, *Journal of range management*, 39(1):81-85.

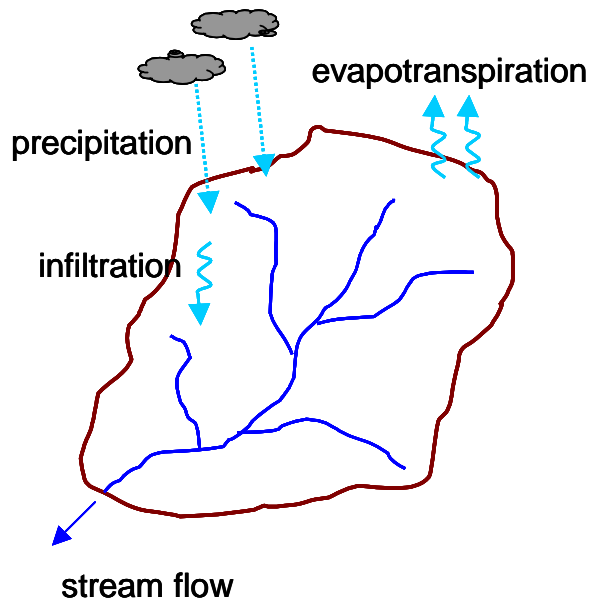
Wildermuth Environmental, 2003. Surface Water Monitoring Program, July 22, 2003.

Young, A.A. and H.F. Blaney, 1942. Use of water by native vegetation, Bulletin No. 50, State of California, Department of Public Works, Division of Water Resources.

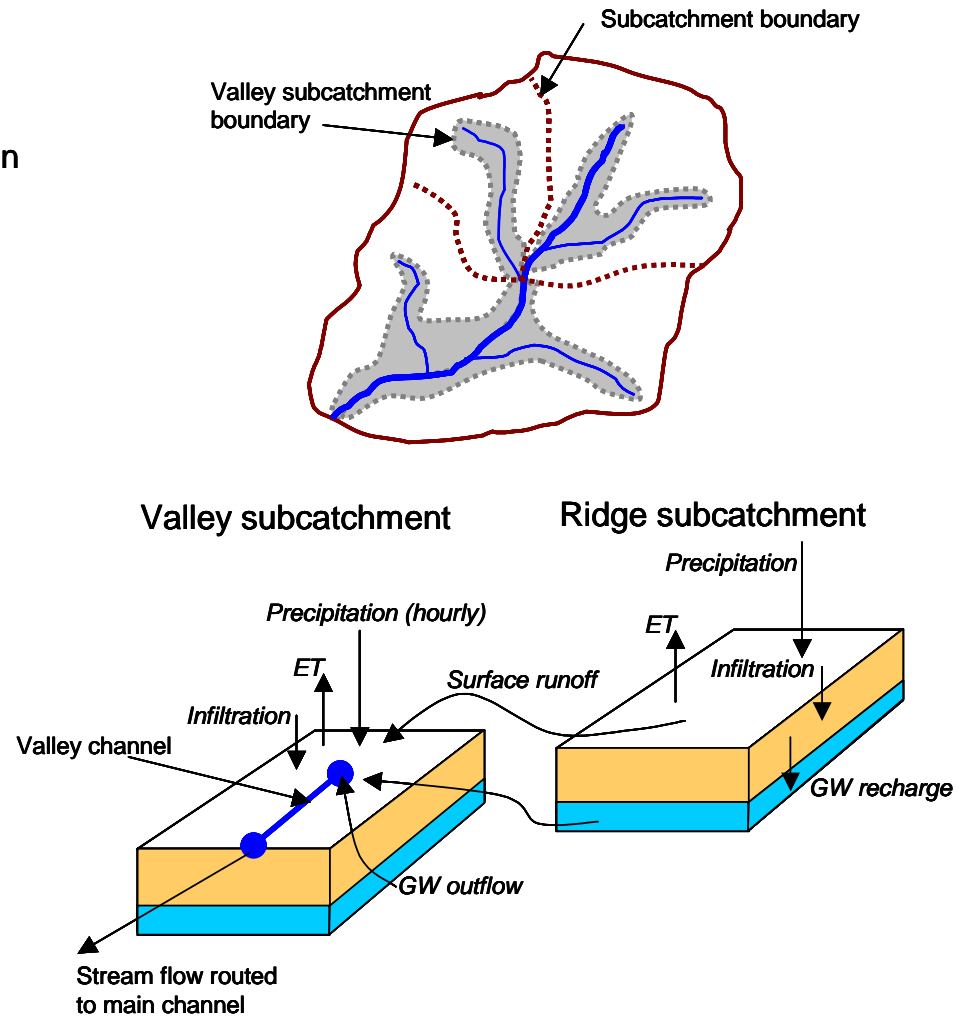


**Figure A-1  
Hydrologic Cycle**

# Hydrologic Processes



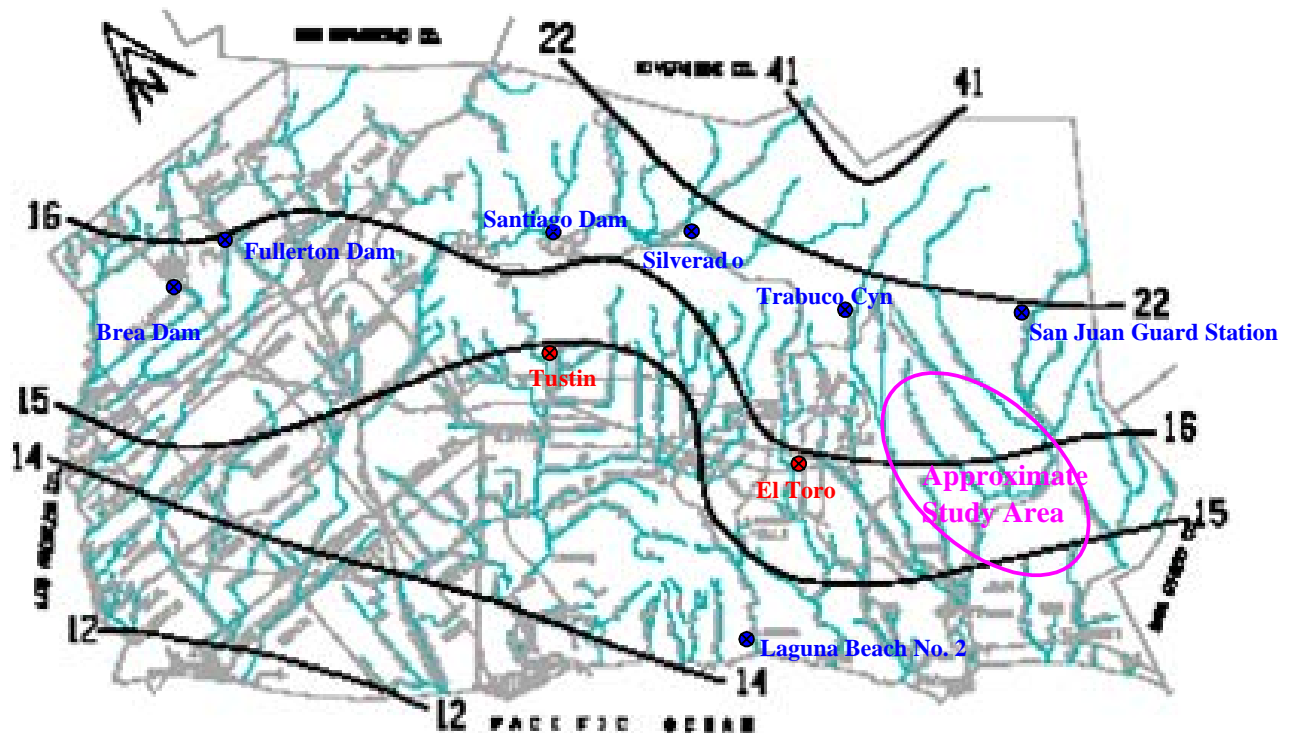
# SWMM Representation



**Figure A-2**  
**Conceptualization of Sub-basin Disaggregation**



**Figure A**  
**Isohyetal Map – 25 Year Mean 1974-1999**



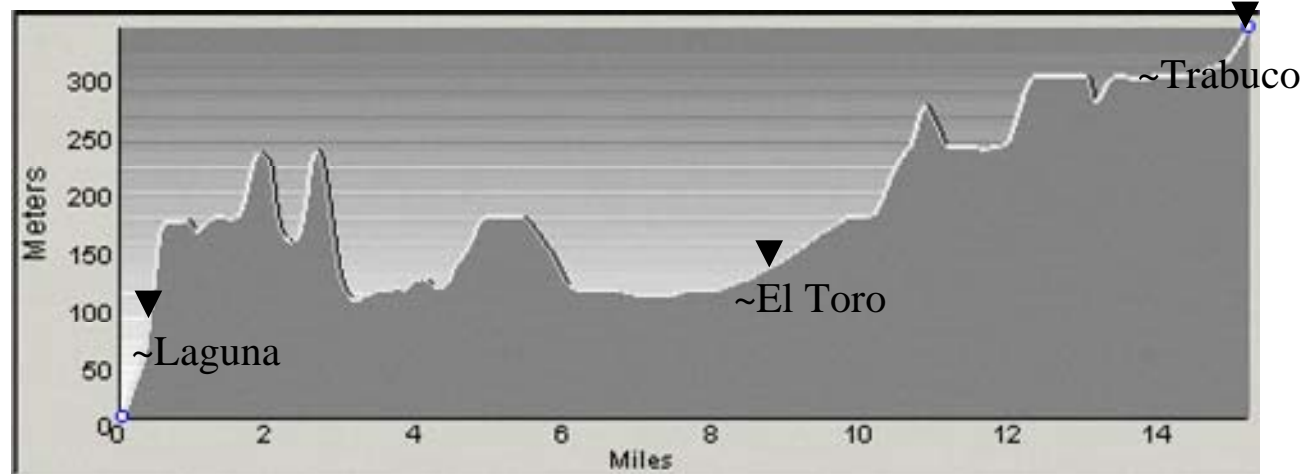
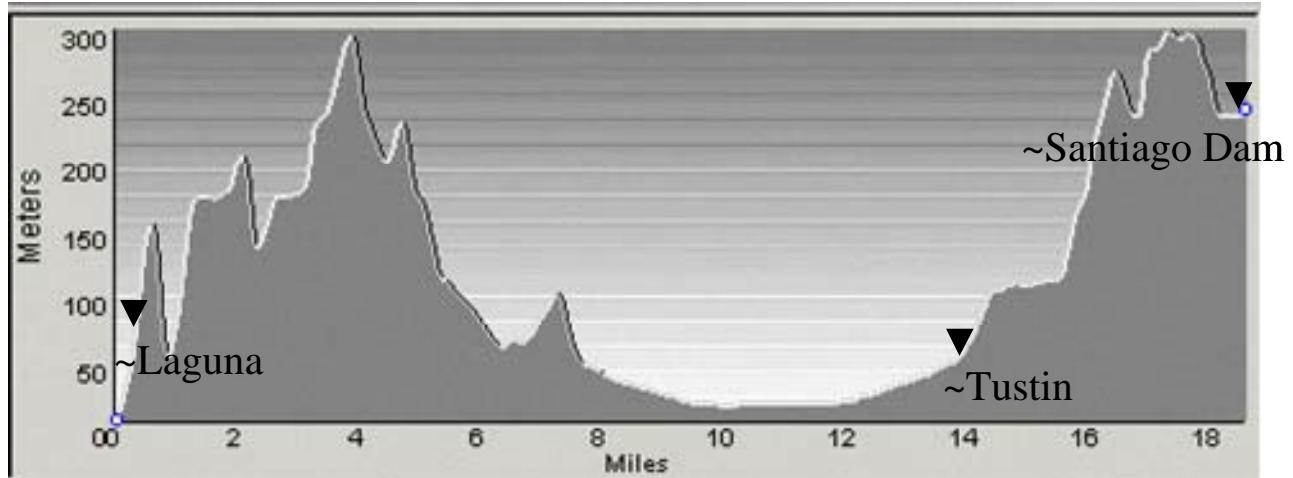
Isohyetal Map Source: County of Orange, Hydrologic Data Report, 2001 -2002 Season

**Figure A-3**  
**Location of Selected Rain Gauges in Orange County**

March 2004

Water Quality Management Plan  
 Rancho Mission Viejo





Source: USGS topographic map for Santa Ana (33117-E1-TM-100), 1983.

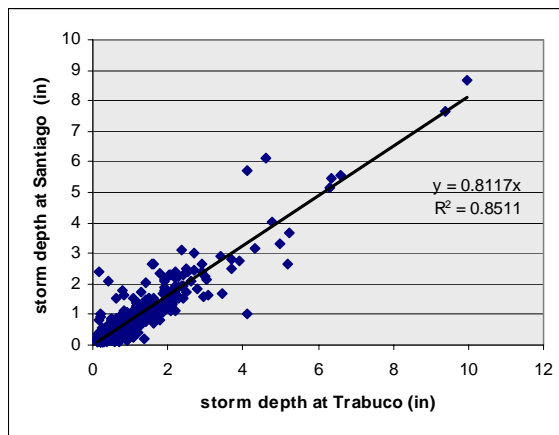
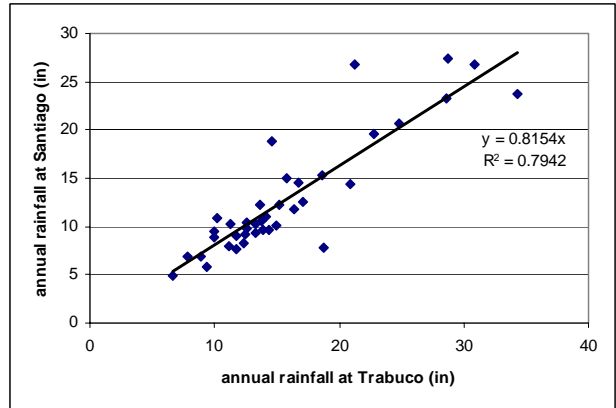
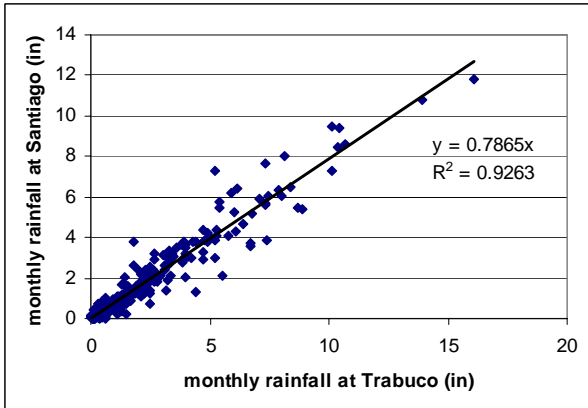
**Figure A-4**  
**Elevation Profiles Between Selected Rain Gauges**

March 2004

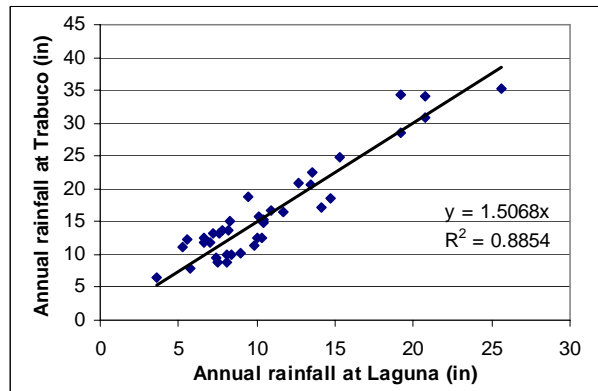
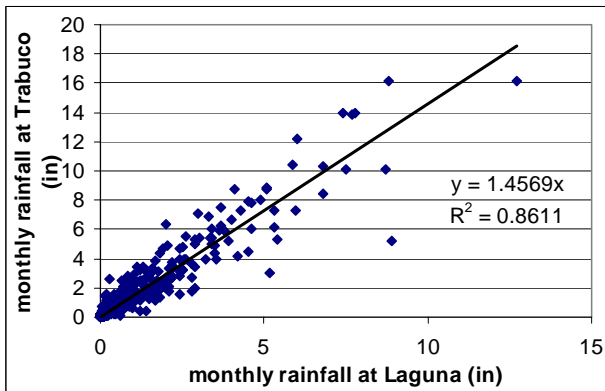
Water Quality Management Plan  
 Rancho Mission Viejo



a) Trabuco-Santiago Dam Correlations



b) Laguna Beach-Trabuco Correlations

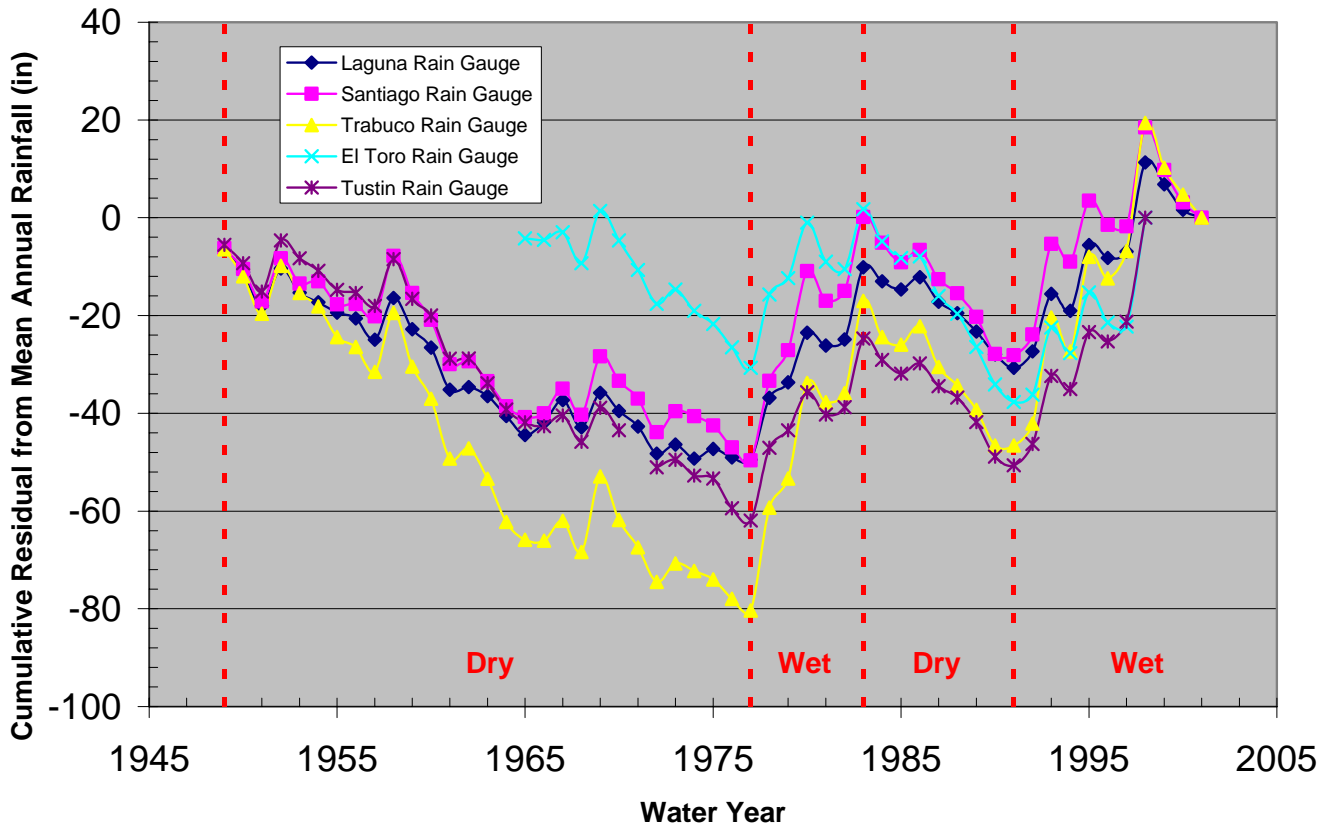


**Figure A-5**  
**Rainfall Correlations for Monthly, Annual, and Storm Event Accumulations of Hourly Precipitation Data**

March 2004

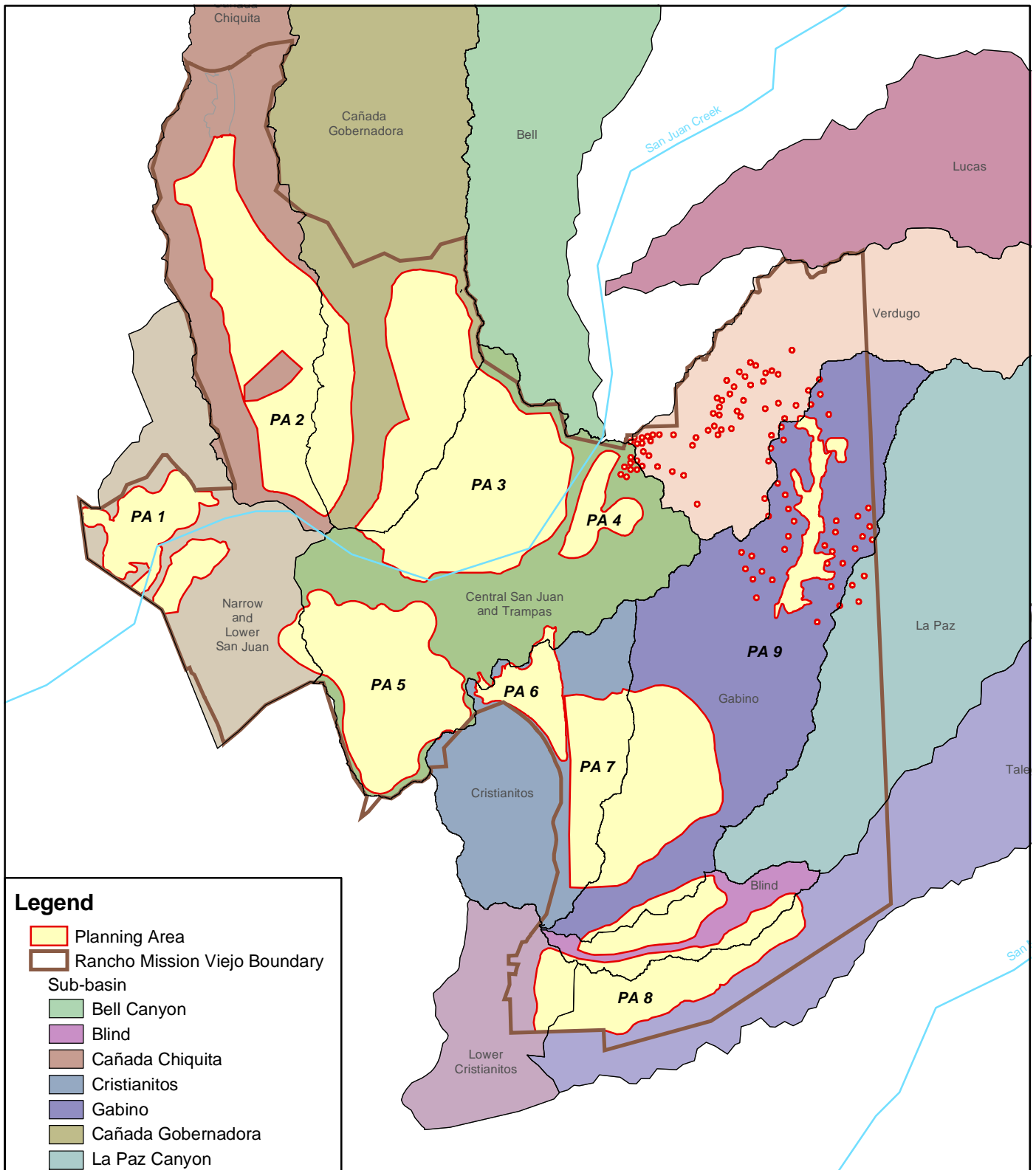
Water Quality Management Plan  
Rancho Mission Viejo





Rain Gauge	Elevation (ft)	Mean annual rainfall (inches/ Water Year)	Median annual rainfall (inches/ Water Year)
Laguna	210	12.36	10.15
Santiago	855	14.43	11.86
Trabuco	970	18.68	15.02
El Toro	445	15.64	12.17
Tustin-Irvine	118	12.99	10.44

**Figure A-6**  
**Rainfall Wet and Dry Cycles**



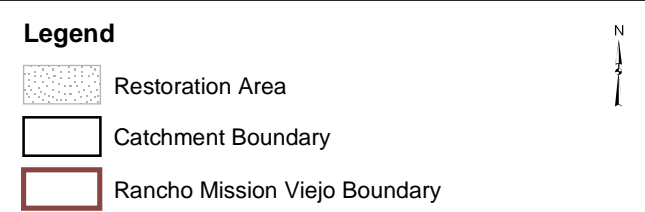
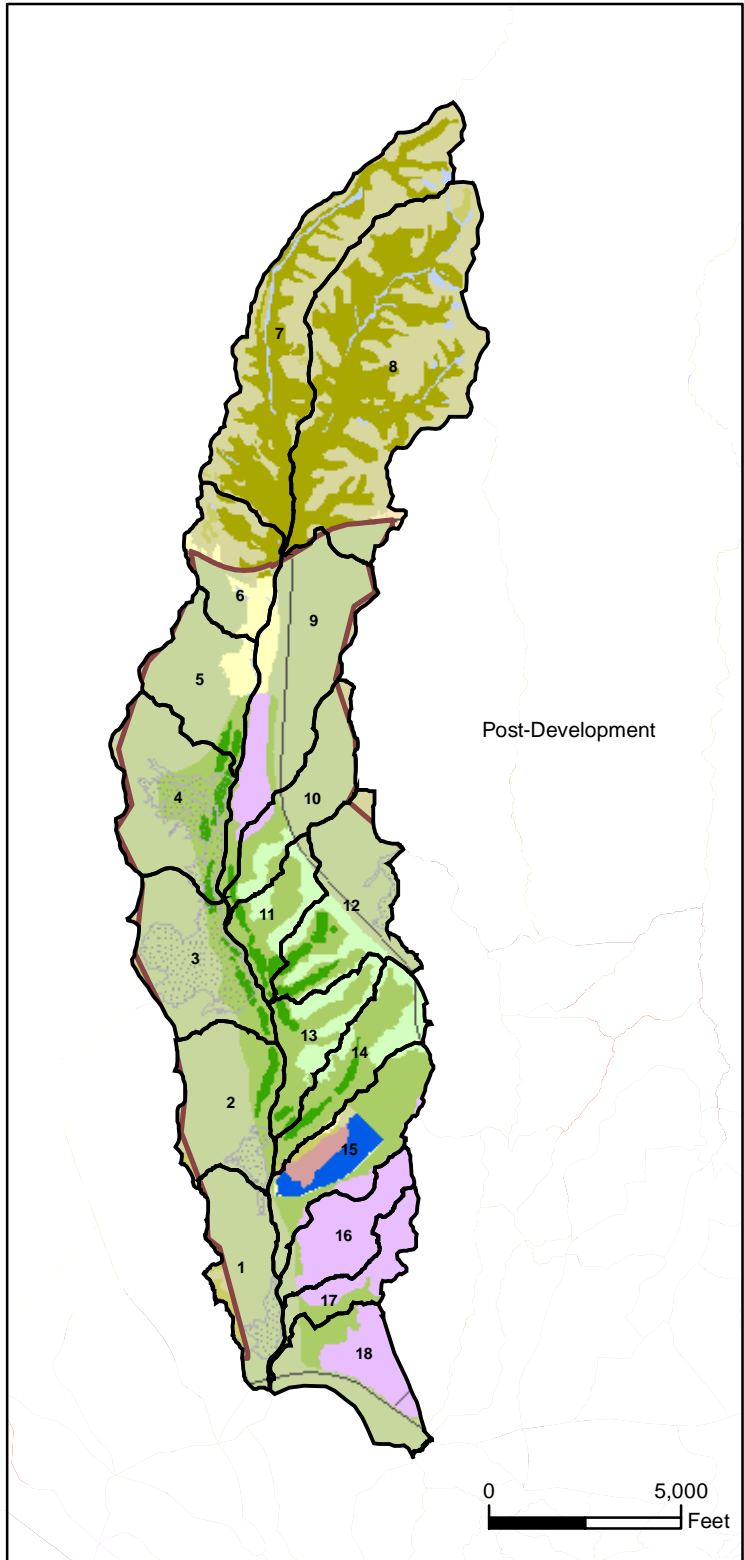
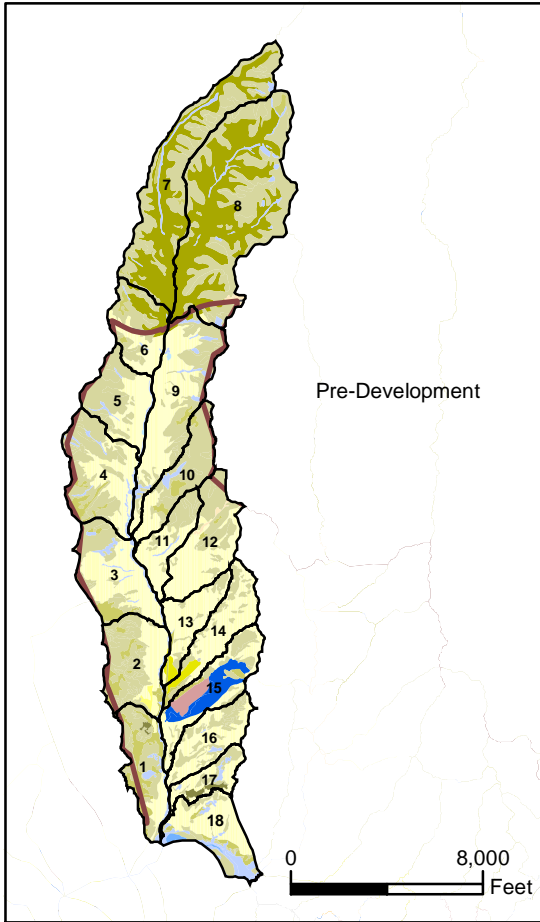
**Figure A-7  
Planning Area Location Map**

0 14,000  
Feet

March 2004

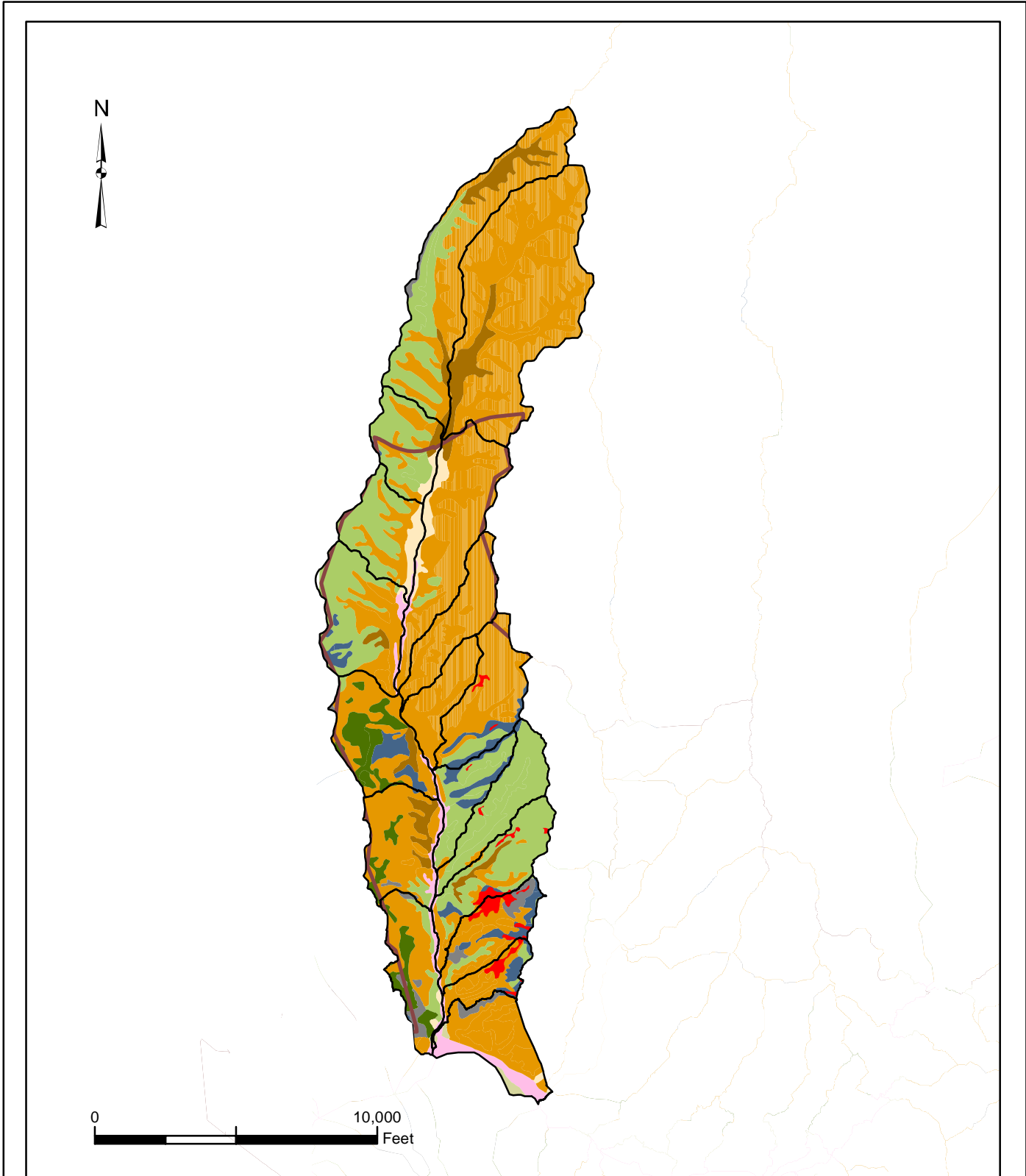
Water Quality Management Plan  
Rancho Mission Viejo








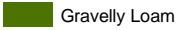

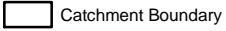


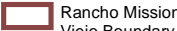
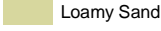
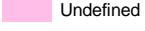
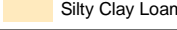
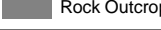
**Figure A-8**  
**Cañada Chiquita Sub-basin**  
**Pre- and Post-Development Land Use**

P:\GIS\RMV\project\WQMP\feb04\FigA8.mxd



**Legend**

**Soil Textures**

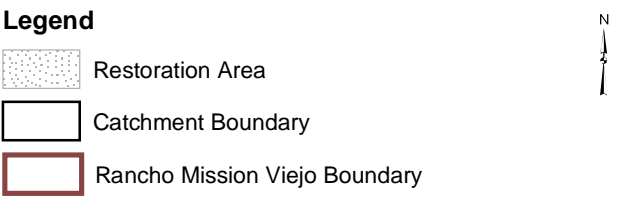
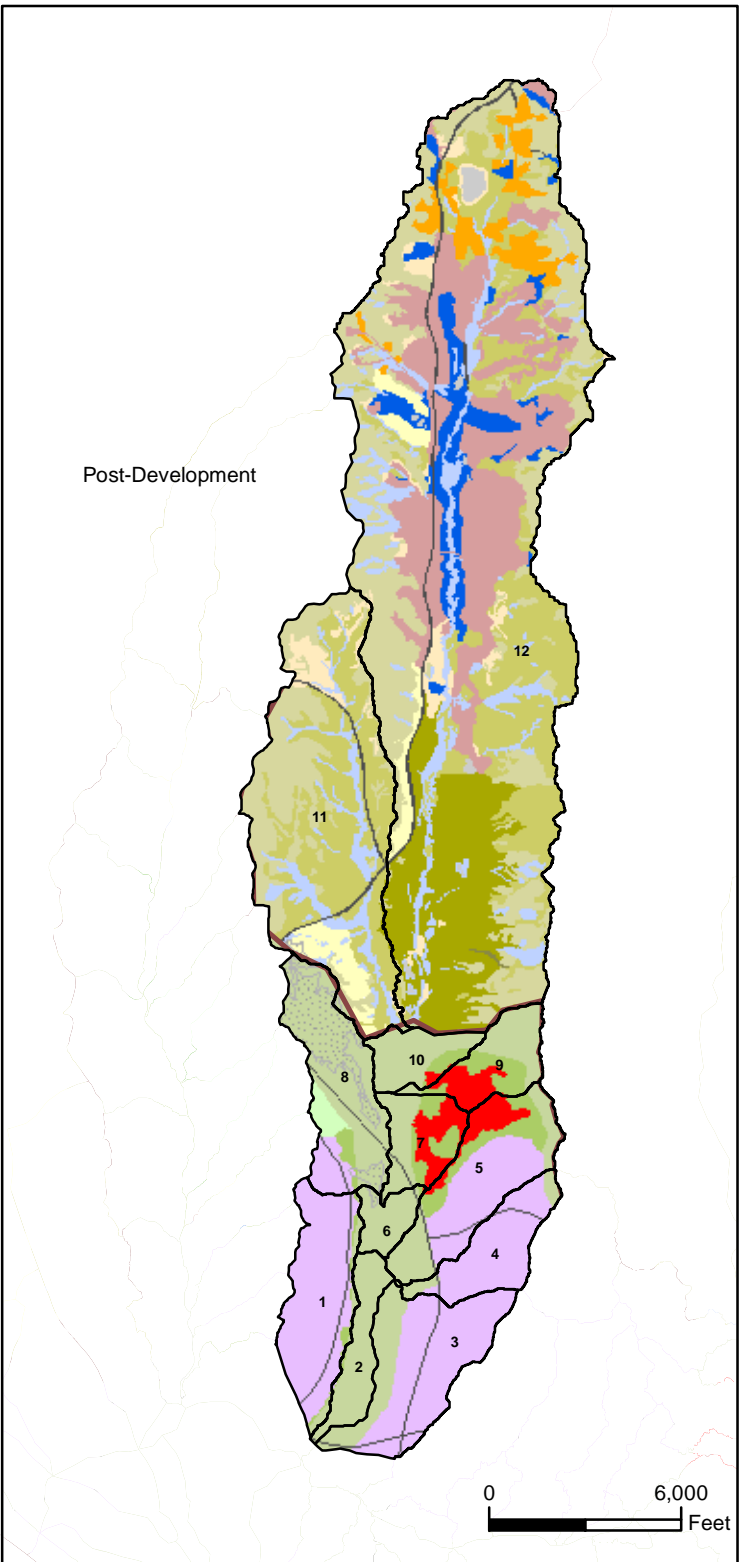
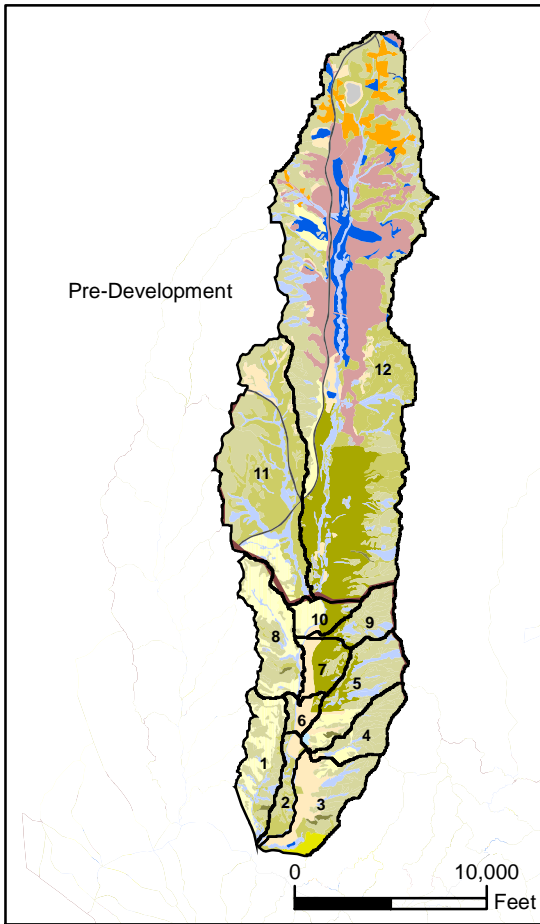
- |   |  |   |
|---|--|---|
|  Clay            |  Sand         |  Hardpan                       |
|  Gravelly Loam   |  Sandy Loam   |  Catchment Boundary            |
|  Clay Loam       |  Loam         |  Rancho Mission Viejo Boundary |
|  Loamy Sand      |  Undefined    |   |
|  Silty Clay Loam |  Rock Outcrop |   |

**Figure A-9**  
**Cañada Chiquita Sub-basin**  
**Soil Texture Distribution**

March 2004

Water Quality Management Plan  
 Rancho Mission Viejo

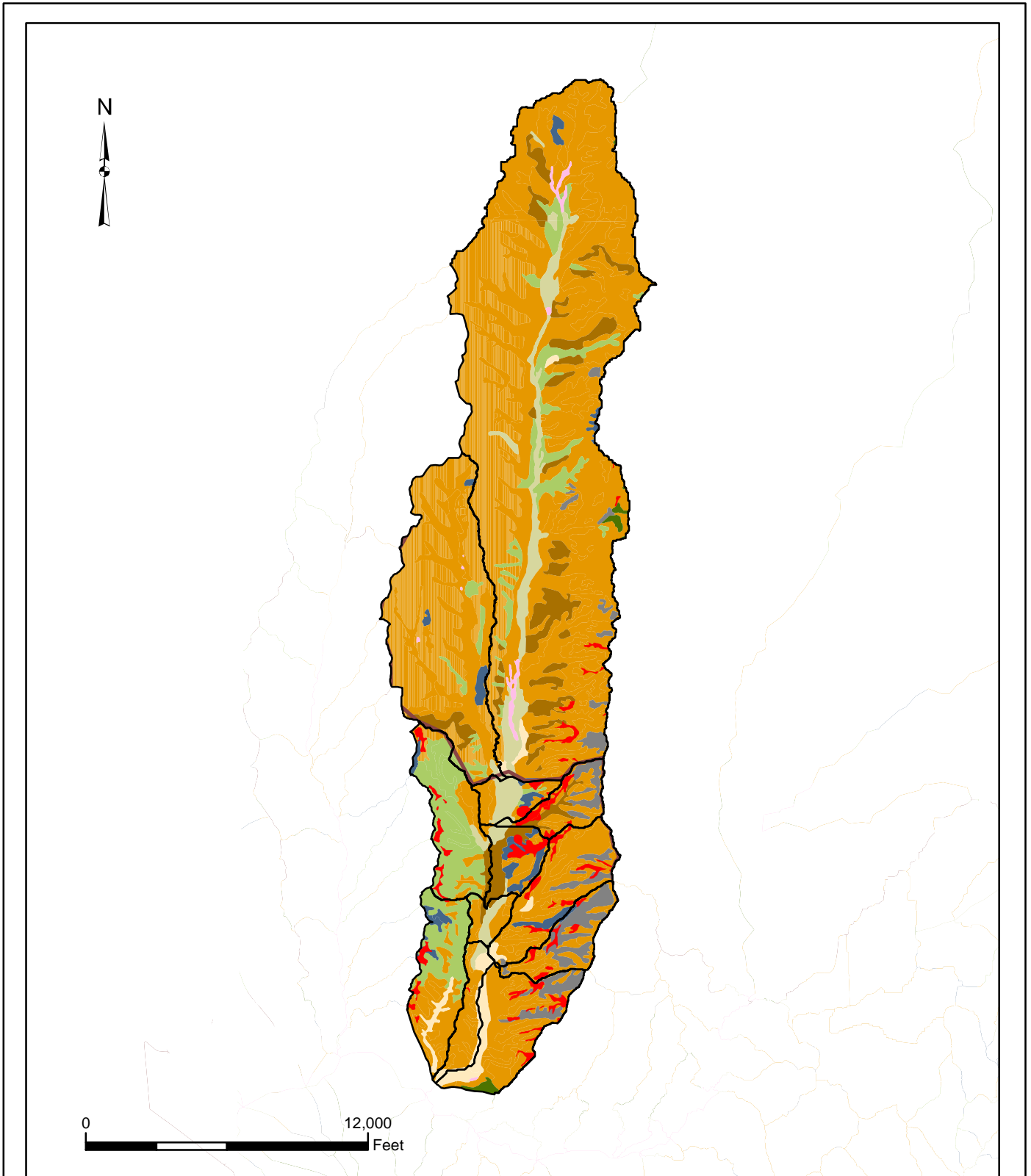




**Figure A-10**  
**Cañada Gobernadora Sub-basin**  
**Pre- and Post-Development Land Use**

P:\GIS\RMV\project\WQMP\Feb04\FigA10.mxd





**Legend**

**Soil Textures**

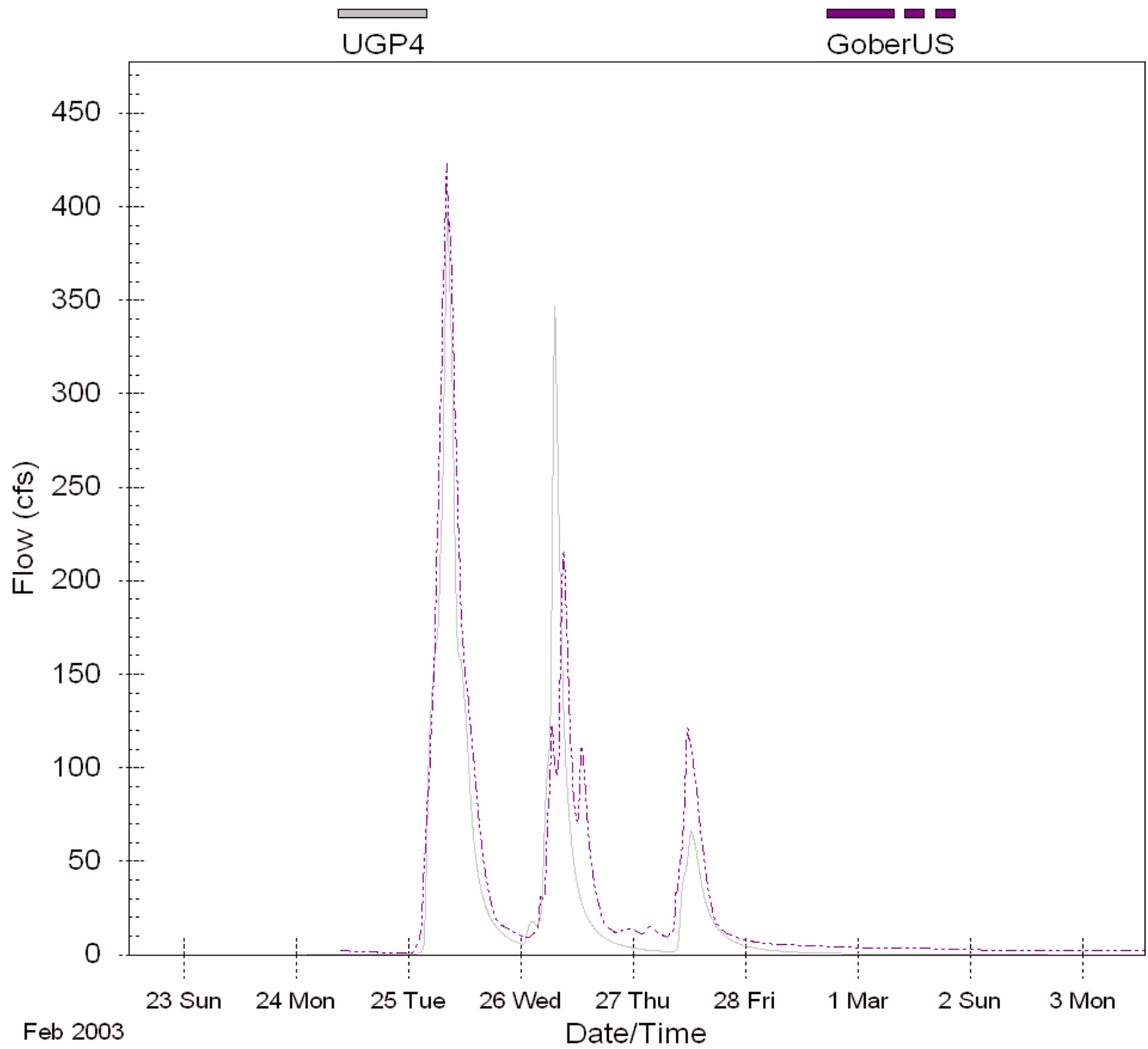
- |                 |              |                               |
|-----------------|--------------|-------------------------------|
| Clay            | Sand         | Hardpan                       |
| Gravelly Loam   | Sandy Loam   | Catchment Boundary            |
| Clay Loam       | Loam         | Rancho Mission Viejo Boundary |
| Loamy Sand      | Undefined    |                               |
| Silty Clay Loam | Rock Outcrop |                               |

**Figure A-11**  
**Cañada Gobernadora Sub-basin**  
**Soil Texture Distribution**

March 2004

Water Quality Management Plan  
 Rancho Mission Viejo





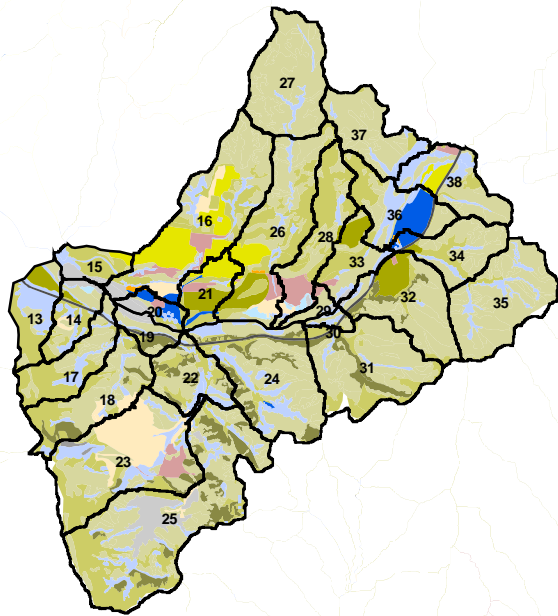
**Figure A-12**  
**Comparison of Measured and Simulated Hydrographs for Upper Gobernadora**

March 2004

Water Quality Management Plan  
 Rancho Mission Viejo

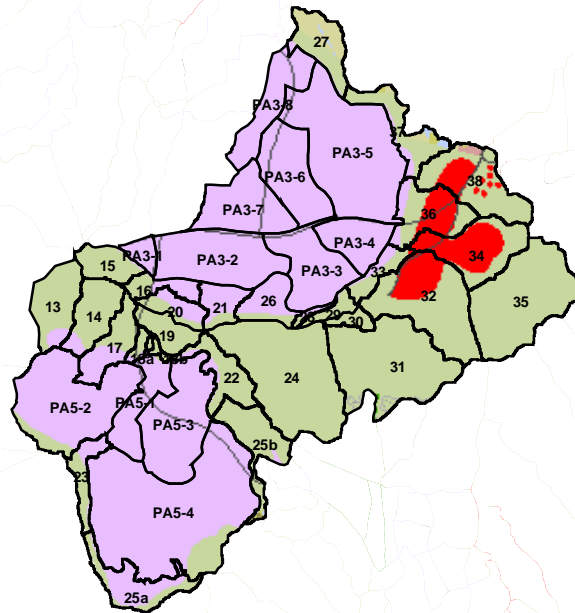


Pre-Development



0 7,000 Feet

Post-Development

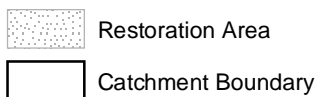


0 7,000 Feet

**Land Use**



**Legend**

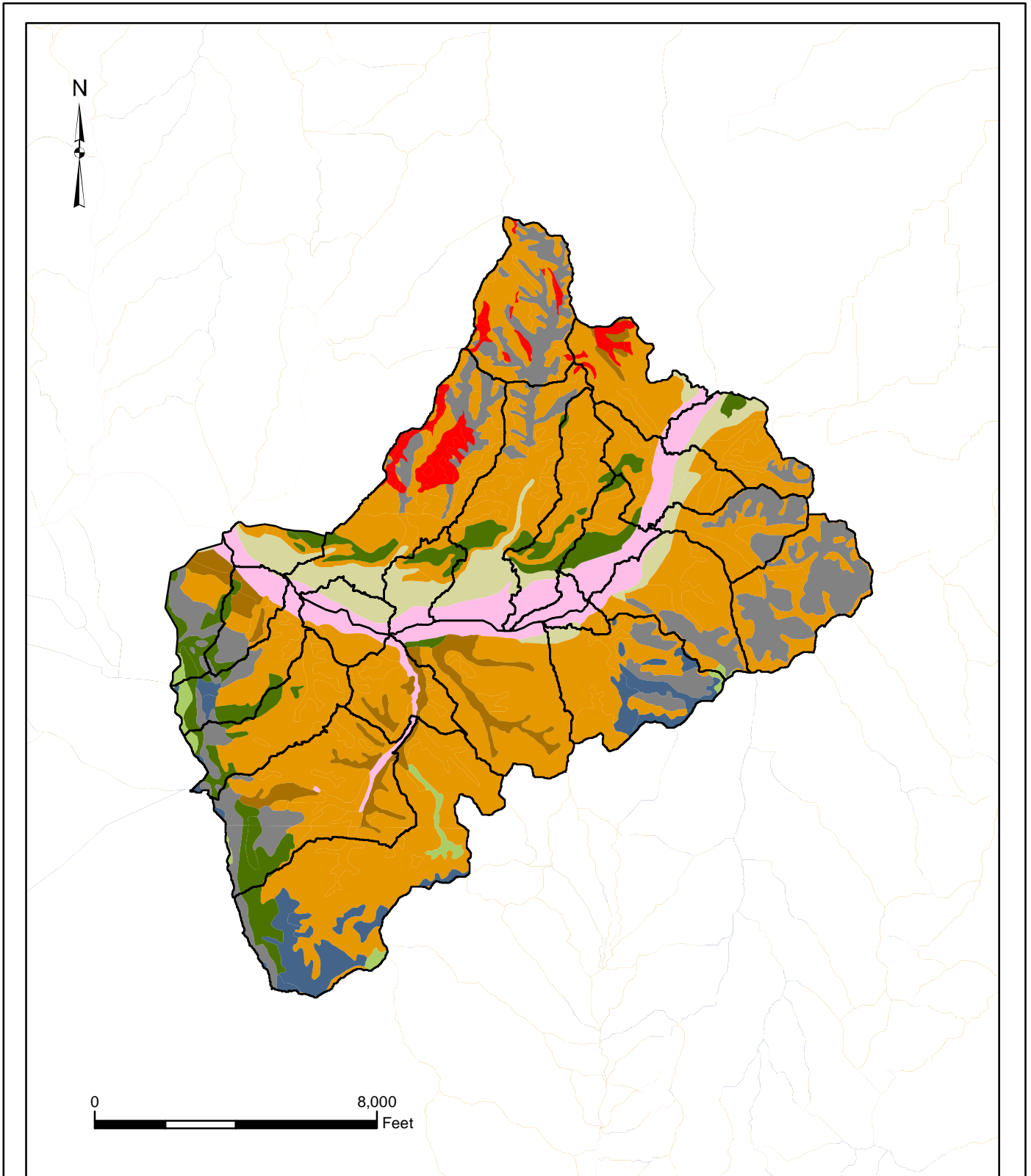


**Figure A-13**  
**Central San Juan and Trampas Sub-basin**  
**Pre- and Post-Development Land Use**

March 2004




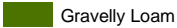

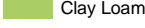

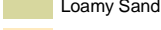
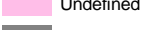
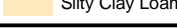
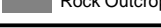

Water Quality Management Plan  
 Rancho Mission Viejo





**Legend**

**Soil Textures**

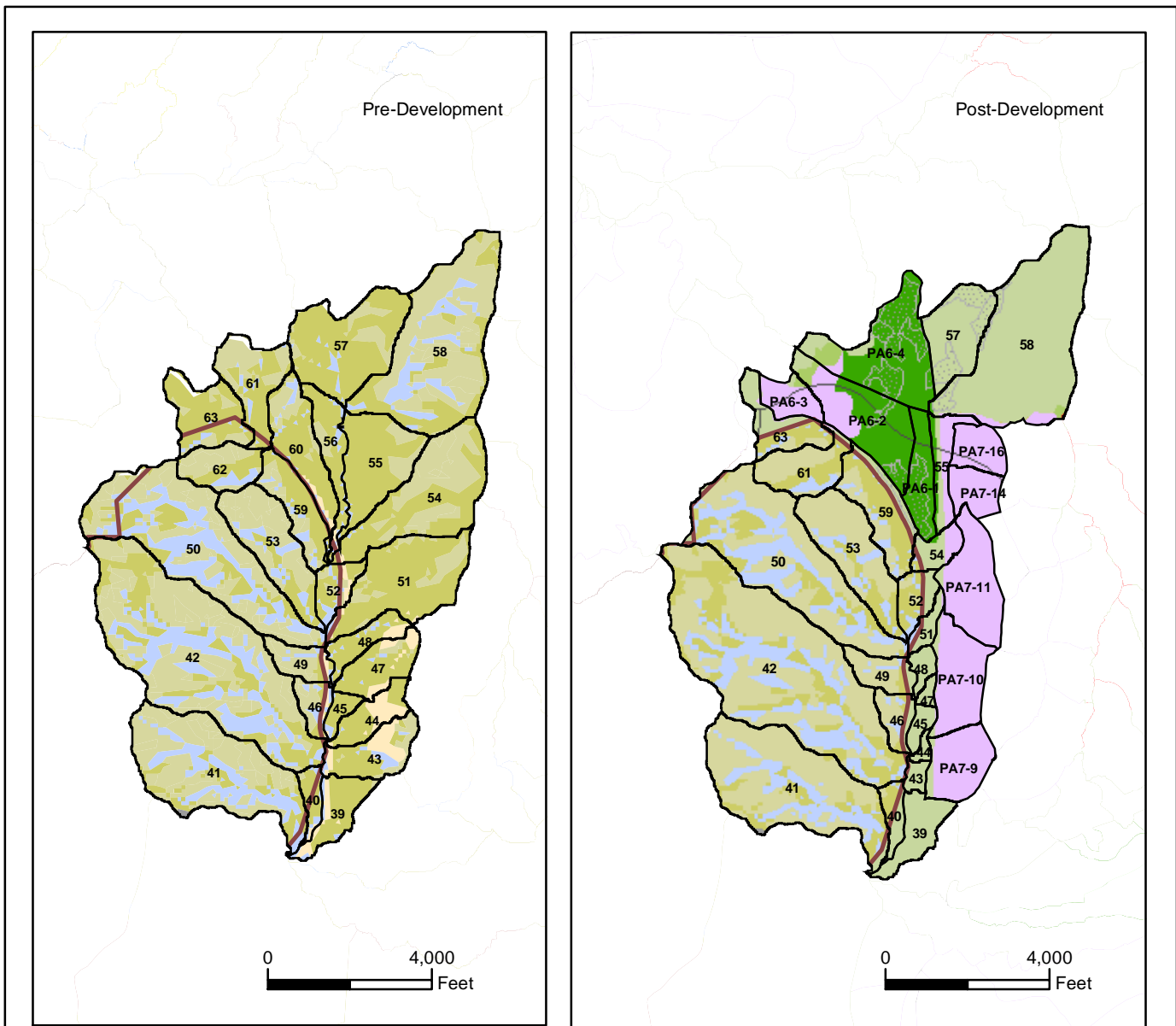
- |   |  |  |
|---|--|--|
|  Clay            |  Sand         |  Hardpan            |
|  Gravelly Loam   |  Sandy Loam   |  |
|  Clay Loam       |  Loam         |  |
|  Loamy Sand      |  Undefined    |  |
|  Silty Clay Loam |  Rock Outcrop |  |
|   |  |  Catchment Boundary |

**Figure A-14**  
**Central San Juan and Trampas Sub-basin**  
**Soil Texture Distribution**

March 2004

Water Quality Management Plan  
 Rancho Mission Viejo





Land Use			
	General Agriculture		Non Reserve Open Space
	Orchards		Reserve Open Space
	Nurseries		Proposed Developed Area
	Barren		Existing Developed Area
	Dunes		Casitas
	Native Vegetation		Estate
	Grassland		Rural Residential
	Forest		Meadow/Marsh
			Riparian & Willow
			Streams & Creeks
			Parks
			Golf Residential
			Golf Resort
			Golf Planned
			Quarry
			Rocks, Cliffs & Outcrop
			Transportation

Legend	
	Restoration Area
	Catchment Boundary
	Rancho Mission Viejo Boundary

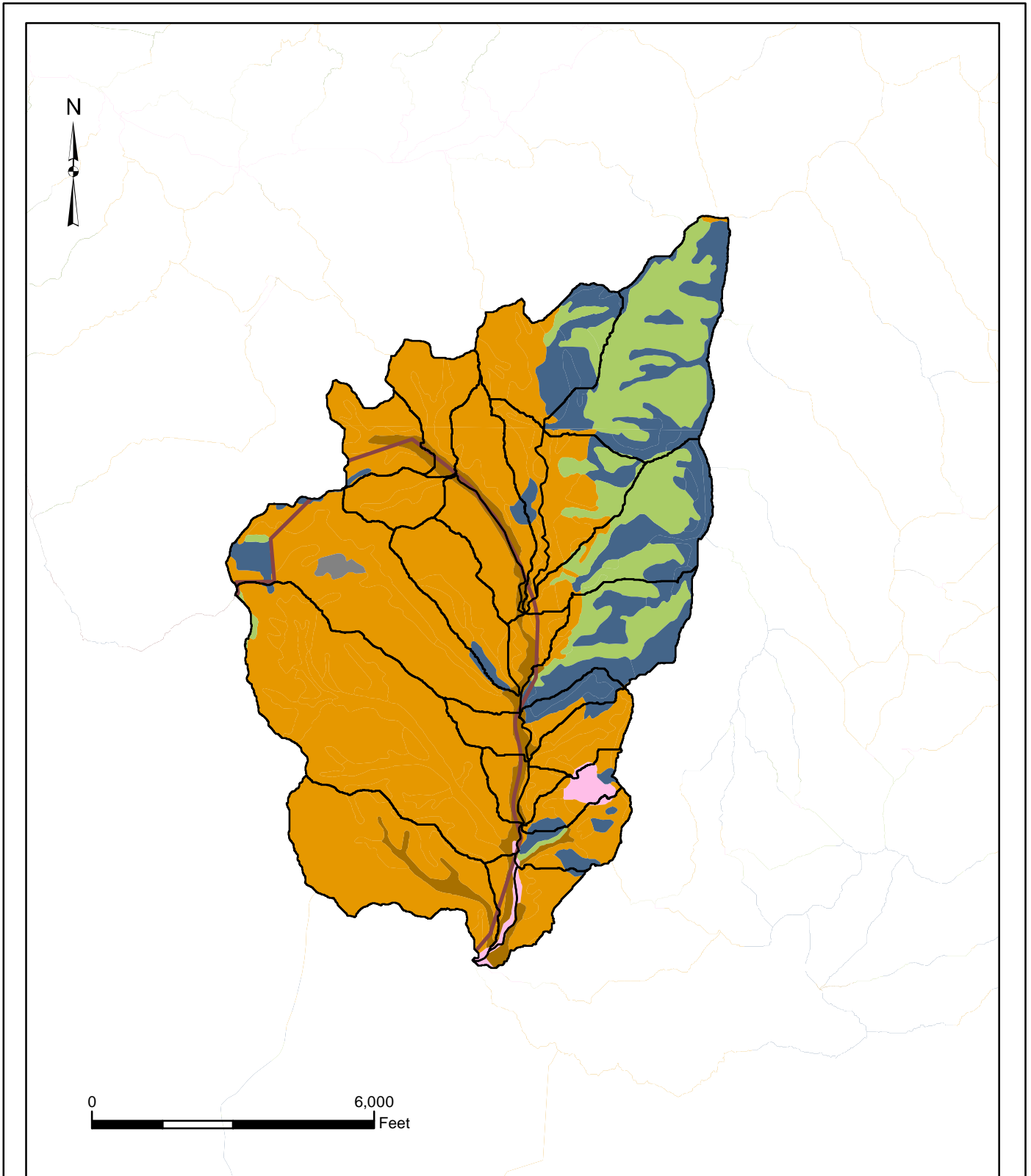


**Figure A-15**  
**Crisianitos Sub-basin**  
**Pre- and Post-Development Land Use**

March 2004




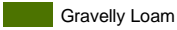




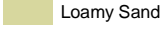
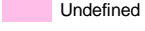
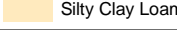
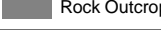
Water Quality Management Plan  
 Rancho Mission Viejo





**Legend**

**Soil Textures**

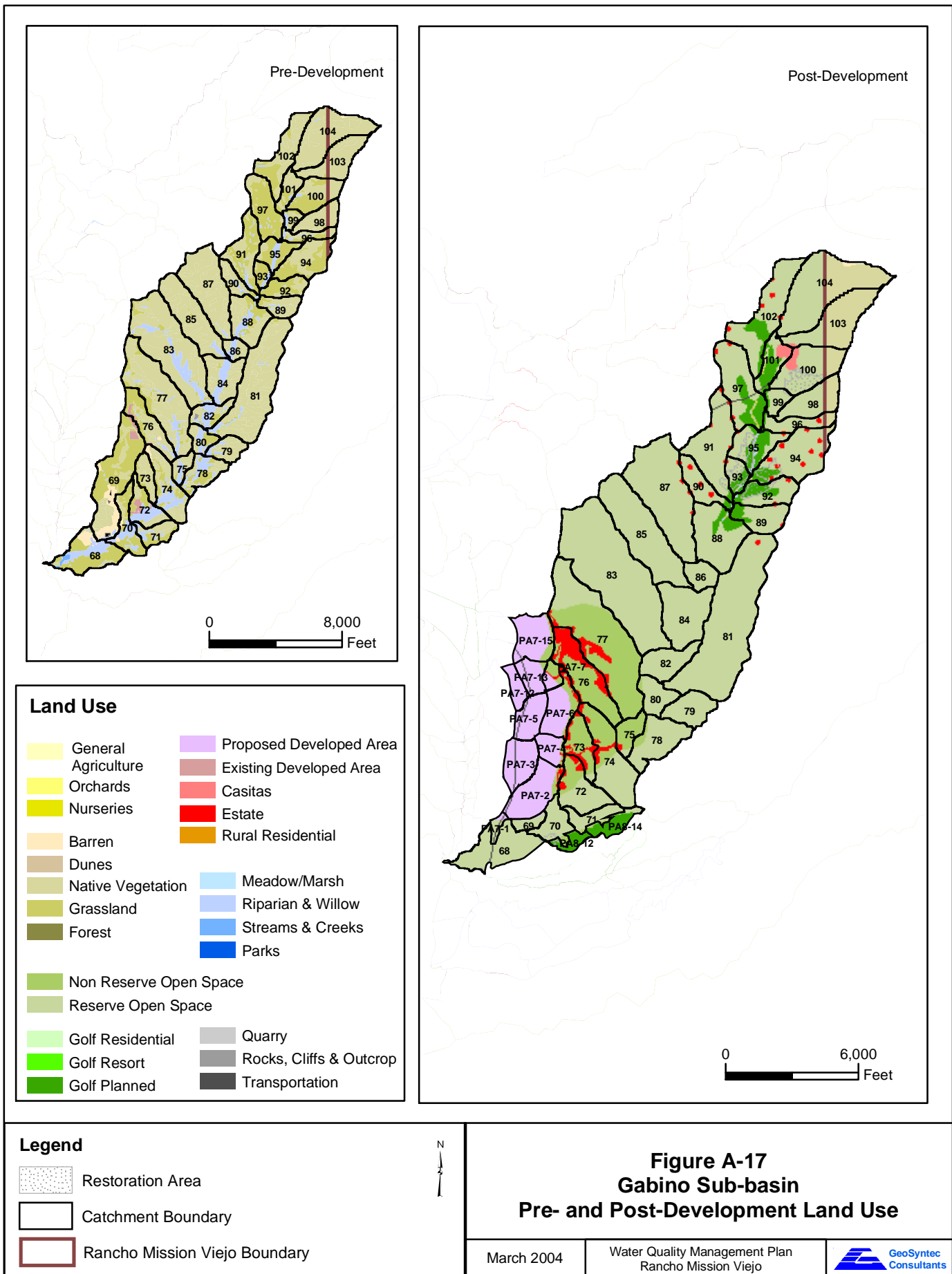
- |   |  |   |
|---|--|---|
|  Clay            |  Sand         |  Catchment Boundary            |
|  Gravelly Loam   |  Sandy Loam   |  Rancho Mission Viejo Boundary |
|  Clay Loam       |  Loam         |   |
|  Loamy Sand      |  Undefined    |   |
|  Silty Clay Loam |  Rock Outcrop |   |

**Figure A-16**  
**Cristianitos Sub-basin**  
**Soil Texture Distribution**

March 2004

Water Quality Management Plan  
 Rancho Mission Viejo





Pre-Development

Post-Development

0 8,000 Feet

0 6,000 Feet

**Land Use**

- |                        |                         |
|------------------------|-------------------------|
| General Agriculture    | Proposed Developed Area |
| Orchards               | Existing Developed Area |
| Nurseries              | Casitas                 |
| Barren                 | Estate                  |
| Dunes                  | Rural Residential       |
| Native Vegetation      | Meadow/Marsh            |
| Grassland              | Riparian & Willow       |
| Forest                 | Streams & Creeks        |
|                        | Parks                   |
| Non Reserve Open Space |                         |
| Reserve Open Space     |                         |
| Golf Residential       | Quarry                  |
| Golf Resort            | Rocks, Cliffs & Outcrop |
| Golf Planned           | Transportation          |

**Legend**

- Restoration Area
- Catchment Boundary
- Rancho Mission Viejo Boundary

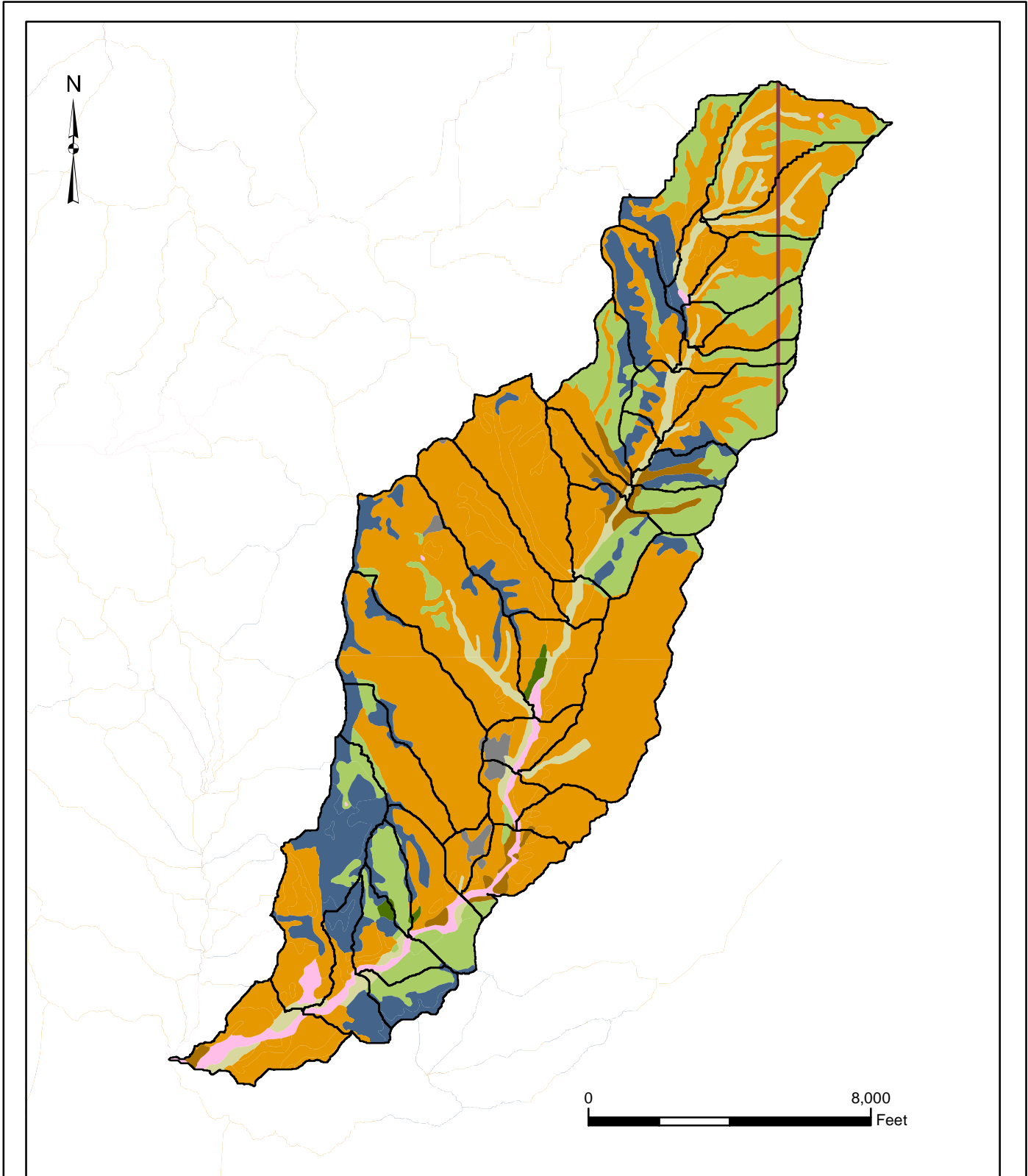


**Figure A-17**  
**Gabino Sub-basin**  
**Pre- and Post-Development Land Use**

March 2004

Water Quality Management Plan  
 Rancho Mission Viejo





**Legend**

**Soil Textures**

- |                 |              |   |
|-----------------|--------------|---|
| Clay            | Sand         | Catchment Boundary<br>Rancho Mission Viejo Boundary |
| Gravelly Loam   | Sandy Loam   |   |
| Clay Loam       | Loam         |   |
| Loamy Sand      | Undefined    |   |
| Silty Clay Loam | Rock Outcrop |   |

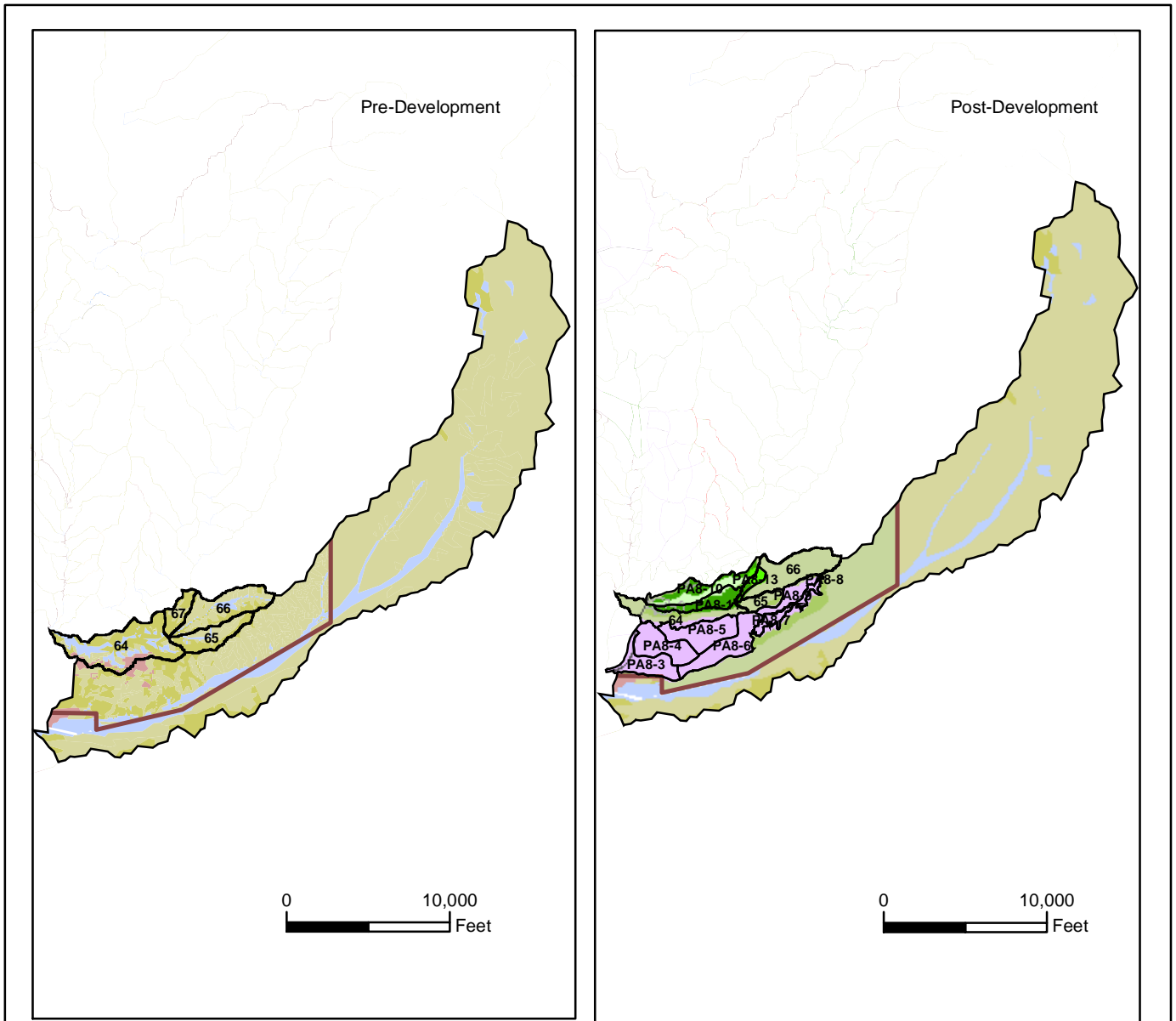
**Figure A-18**  
**Gabino Sub-basin**  
**Soil Texture Distribution**

March 2004

Water Quality Management Plan  
Rancho Mission Viejo







**Land Use**

General Agriculture	Non Reserve Open Space	Proposed Developed Area	Meadow/Marsh
Orchards	Reserve Open Space	Existing Developed Area	Riparian & Willow
Nurseries	Golf Residential	Casitas	Streams & Creeks
Barren	Golf Resort	Estate	Parks
Dunes	Golf Planned	Rural Residential	Quarry
Native Vegetation			Rocks, Cliffs & Outcrop
Grassland			Transportation
Forest			

**Legend**

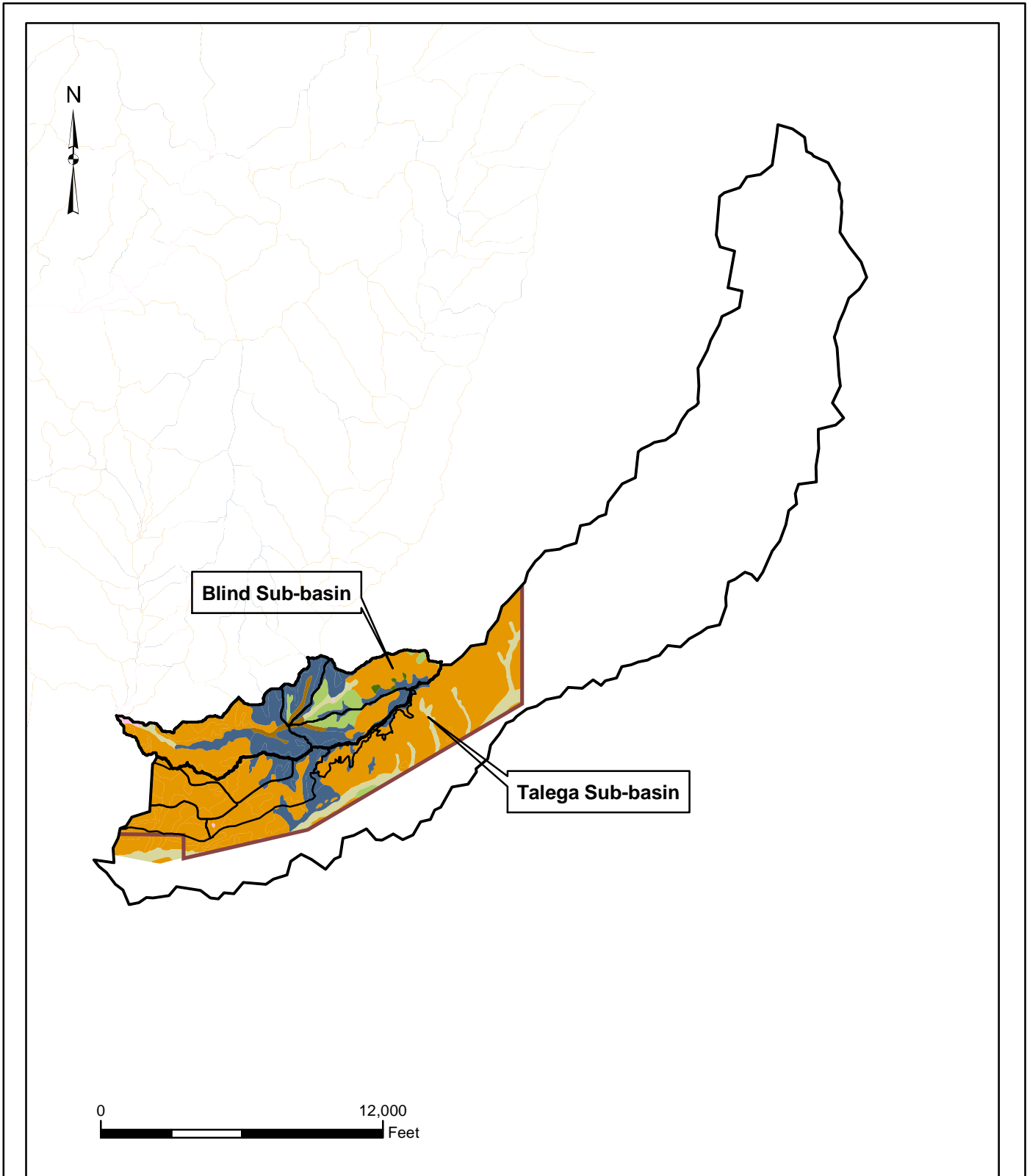
Restoration Area

Catchment Boundary

N  
↑  
↓

**Figure A-19**  
**Pre- and Post-Development**  
**Land Uses in the Talega**  
**and Blind Sub-basins**

March 2004	Water Quality Management Plan Rancho Mission Viejo	
------------	---	--



**Legend**

**Soil Textures**

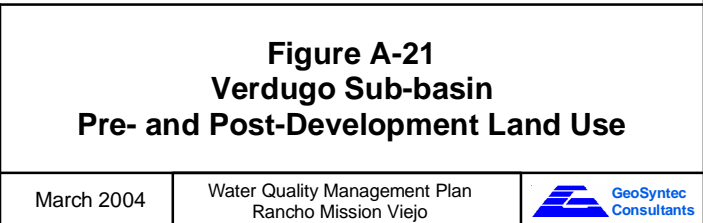
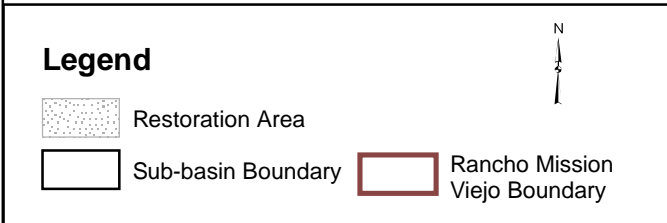
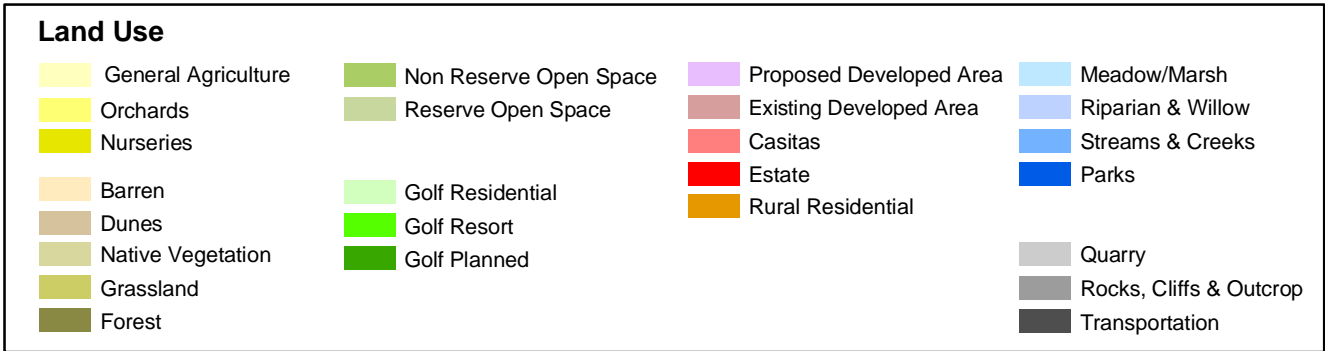
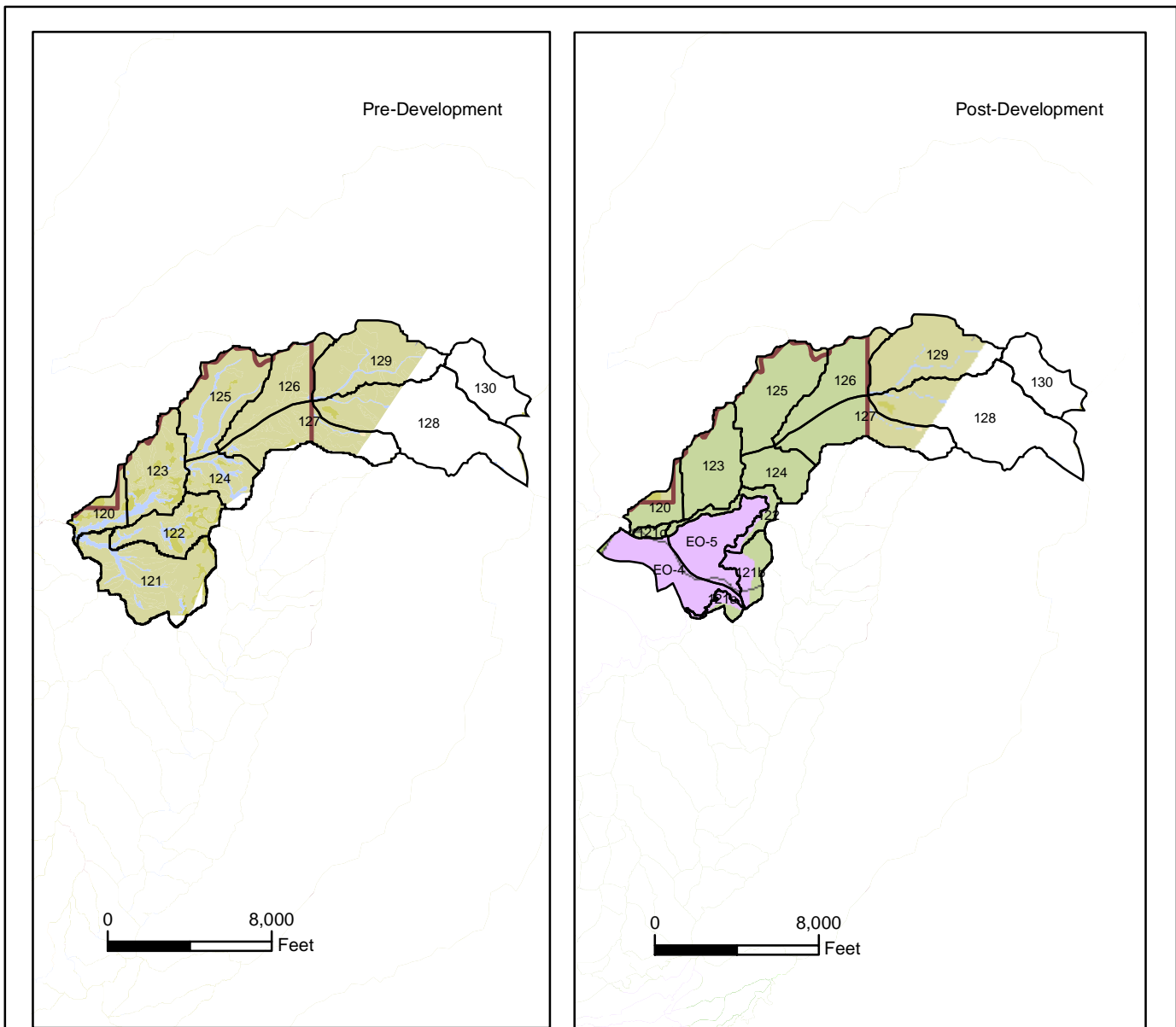
- |                 |              |                               |
|-----------------|--------------|-------------------------------|
| Clay            | Sand         | Catchment Boundary            |
| Gravelly Loam   | Sandy Loam   | Sub-basin Boundary            |
| Clay Loam       | Loam         | Rancho Mission Viejo Boundary |
| Loamy Sand      | Undefined    |                               |
| Silty Clay Loam | Rock Outcrop |                               |

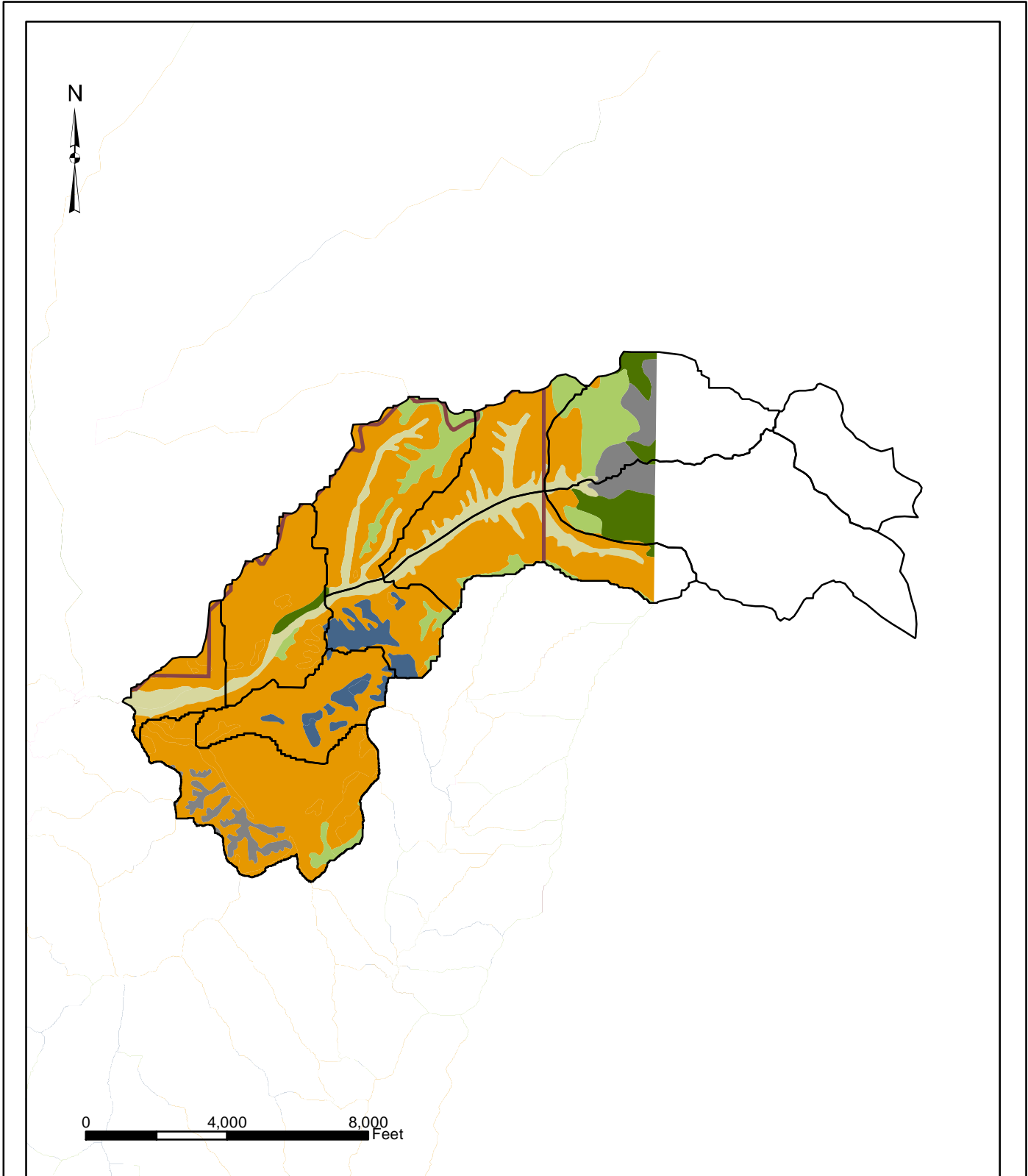
**Figure A-20**  
**Blind and Talega Sub-basins**  
**Soil Texture Distribution**

March 2004

Water Quality Management Plan  
 Rancho Mission Viejo



















**Legend**

**Soil Textures**

- |   |  |   |
|---|--|---|
|  Clay            |  Sand         |  Sub-basin Boundary<br> Rancho Mission Viejo Boundary |
|  Gravelly Loam   |  Sandy Loam   |   |
|  Clay Loam       |  Loam         |   |
|  Loamy Sand      |  Undefined    |   |
|  Silty Clay Loam |  Rock Outcrop |   |

**Figure A-22**  
**Verdugo Sub-basin**  
**Soil Texture Distribution**

March 2004

Water Quality Management Plan  
 Rancho Mission Viejo



**Appendix B:**  
**Water Quality Model Description**

## Table of Contents

B-1	Introduction.....	B-1
B-2	Water Quality Model Methodology.....	B-2
B-2.1	Average Annual Pollutant Loads.....	B-2
B-2.2	Average Annual Pollutant Concentrations.....	B-3
B-2.3	BMP Treatment.....	B-3
B-3	Model Inputs Parameters .....	B-4
B-3.1	Pre- and Post Development Land Uses.....	B-5
B-3.2	EMC Monitoring Data .....	B-5
B-3.2.1	LA County Stormwater Monitoring Program.....	B-5
B-3.2.2	Ventura County Monitoring Program.....	B-9
B-3.2.3	Statistical Analysis.....	B-9
B-3.3	Average Annual Runoff Volume .....	B-14
B-3.4	BMP Effluent Quality .....	B-14
B-4	References.....	B-16

**List of Tables**

Table B-1: Land Use Stations Monitored in the LA County Monitoring Program..... B-7  
Table B-2: Monitoring Data Detection Limits and % of Detects for Modeled Parameters & Land Uses..... B-11  
Table B-3: Estimated Arithmetic Mean EMC Values for Modeled Parameters & Land Uses.....B-12  
Table B-4: Estimated Coefficient of Variation for Modeled Parameters & Land Uses ..... B-13  
Table B-5: BMP Performance- Modeled Effluent Concentration for Stormwater Treatment in Detention Basins and Vegetated Swales..... B-15

**List of Figures**

Figure B-1 An Example Illustration of TSS Loads and Concentrations for Canada Chiquita

## **B-1 INTRODUCTION**

A water quality model was developed to assess the potential impacts of the proposed development in Rancho Mission Viejo on the receiving water quality, and to evaluate the effectiveness of the proposed stormwater treatment systems. Three different conditions were evaluated with the water quality model:

1. pre-development
2. post-development without treatment
3. post-development with treatment

The water quality model is an empirical model that applies monitored water quality data to modeled stormwater runoff flows. The model was developed to provide a simple yet reasonably reliable method for predicting pollutant loads and concentrations that occur as a result of development. Average annual loads and concentrations are calculated and presented for the dry, wet and total period of record. The model also predicts the improvement in water quality due to the implementation of Best Management Practices (BMPs). The objectives of the water quality model are as follows:

- Compare predicted loads and concentrations for pre-development, post-development, and post-development with BMP conditions (example shown in Figure B-1).
- Estimate the percent change in pollutant loads and concentrations by comparing pre-development condition to post-development conditions with BMPs.
- Compare concentrations of pollutants in post-development condition with BMPs with the appropriate water quality criteria, and/or water quality design standards.

The water quality model was used to evaluate the following pollutants for pre-development conditions and post-development conditions with and without treatment:

- Total Suspended Solids
- Total Phosphorus
- Dissolved Phosphorus
- Nitrogen (total, nitrate)
- Total Aluminum
- Dissolved Cadmium
- Total and Dissolved Copper
- Total and Dissolved Lead
- Total and Dissolved Zinc

These pollutants are commonly associated with runoff from urban areas. The pollutant event mean concentrations (EMCs) used in the model were adapted from local monitoring data.



As with all environmental modeling, the accuracy of model results is heavily dependent on how well the hydrologic, water quality, and BMP effectiveness data describe the actual site characteristics. Consequently, local and regional data (as opposed to national data) are used to the fullest extent possible. This particular model allows for the selection of inputs that reflect regional conditions such as local water quality monitoring data and modeled runoff volumes that incorporate site-specific rainfall, soil and vegetation parameters. BMP effectiveness was estimated using The National Stormwater Best Management Practices Database (UWRRC, 2000).

## **B-2 WATER QUALITY MODEL METHODOLOGY**

In general, pollutant loads are calculated by first estimating average annual runoff volumes for each land use within a given catchment. Runoff volumes from each land use are then multiplied by their corresponding pollutant EMCs to estimate the pollutant loads. BMP effectiveness was determined by multiplying monitored BMP effluent quality by the treated runoff volume. The EMCs and BMP effluent data utilized in the water quality model are summarized in subsequent sections of this appendix. The following sections describe the methodologies and equations used in water quality model.

### **B-2.1 Average Annual Pollutant Loads**

Pollutant loads for each land use were estimated by multiplying the average annual runoff volumes by the corresponding land use EMCs:

$$L_{lu} = Q_{lu} * C_{lu} * 2.719 \frac{lbs / acre - ft}{mg / L} \quad (1)$$

Where:

$L_{lu}$  = Average annual pollutant load for each land use (lbs/yr)

$Q_{lu}$  = Annual runoff volume for each land use (acre-ft/yr)

$C_{lu}$  = EMC for each land use (mg/L)

This provides the average annual pollutant load for each land use within a given catchment. The pollutant loads are then summed for each land use within a sub-basin to provide the total annual pollutant load:

$$L_T = \sum L_{lu} \quad (2)$$

Where:

$L_T$  = Average annual pollutant load for each sub-basin (lbs/yr)

### **B-2.2 Average Annual Pollutant Concentrations**

The average annual pollutant concentrations for each sub-basin are determined by first calculating the total annual runoff volume for the entire sub-basin.

$$Q_T = \sum Q_{iu} \quad (3)$$

The total pollutant load is then divided by the total runoff volume, yielding the average annual pollutant concentration for each sub-basin:

$$C_T = \frac{L_T}{Q_T} * 0.368 \frac{mg / L}{lbs / acre - ft} \quad (4)$$

Where:

$Q_T$  = Total annual runoff volume for each sub-basin (acre-ft/yr)

$C_T$  = Average annual pollutant concentration for each sub-basin (mg/L)

### **B-2.3 BMP Treatment**

The proposed BMPs were incorporated into the model to estimate their effectiveness at reducing pollutant loads into the receiving water. BMP effluent data was adapted from the National Stormwater Best Management Practices Database. This database provides effluent quality from a variety of BMPs. The pollutant loads from each of the proposed BMPs were determined by multiplying the average effluent pollutant concentration by the annual runoff volume treated by the BMP:

$$L_{BMP} = Q_{BMP} * C_{BMP} * 2.719 \frac{lbs / acre - ft}{mg / L} \quad (5)$$

Where:

$L_{BMP}$  = Average annual pollutant load discharged from each BMP (lbs/yr)

$Q_{BMP}$  = Annual runoff volume treated by each BMP (acre-ft/yr)

$C_{BMP}$  = Average pollutant concentration discharged from each BMP (mg/L)

During high intensity or long duration storm events, a portion of the runoff flows could potentially bypass the BMPs. When this occurs, the bypassed flows are not effectively treated by the BMP. Pollutant loads from the bypassed flows are determined by multiplying

the average annual concentration from each sub-basin (calculated by equation 4) by the total annual bypassed volume:

$$L_{bypass} = Q_{bypass} * C_T * 2.719 \frac{lbs / acre - ft}{mg / L} \quad (6)$$

Where:

$L_{bypass}$  = Average annual pollutant load from the bypassed flows (lbs/yr)

$Q_{bypass}$  = Annual bypassed volume (acre-ft/yr)

$C_T$  = Average annual pollutant concentration for each sub-basin (mg/L)

To determine the total pollutant load that is being discharged into the receiving water, the treated and bypassed pollutant loads are summed:

$$L_T = L_{bypass} + L_{BMP} \quad (7)$$

Where:

$L_T$  = Average annual pollutant load from the sub-basin (lbs/yr)

$L_{bypass}$  = Average annual pollutant load from the bypassed flows (lbs/yr)

$L_{BMP}$  = Average annual pollutant load from the treated flows (lbs/yr)

This yields an estimate of the total pollutant load being discharged into the receiving water during post-development conditions with BMPs.

### **B-3 MODEL INPUTS PARAMETERS**

As previously stated, the accuracy of the water quality model is heavily dependent on how well the input parameters, such as the hydrology, water quality, and BMP effectiveness data, describe the actual site characteristics. Because of this, local data was used whenever possible. The primary input data required by the model include:

1. pre- and post-development land uses areas
2. pollutant EMC data for each land use
3. average annual runoff volumes for each land use
4. BMP effluent quality

The following sections describe the source for each of the input parameters.

### **B-3.1 Pre- and Post Development Land Uses**

Land use data was obtained for the existing and proposed conditions for each of the modeled alternatives. The land use types were defined as transportation, single family residential, multi-family residential, commercial, golf course, estates, nurseries, parks, schools, and open space. Each land use type was assigned a pollutant concentration (based on monitoring data) to determine the pollutant loads generated from each land use. Sources of the land use data are described in Appendix A, Section A-3.

### **B-3.2 EMC Monitoring Data**

The most accurate estimates of pollutant concentrations are based on the analysis of stormwater sampling information collected during monitoring programs conducted near or at the project site. However, due to the variable nature of runoff concentration data, it takes numerous monitored storms collected over several years to gather enough data to produce statistically significant results. Therefore it is not practical or cost effective to collect local data for each development project. More commonly, average pollutant concentrations estimated in published historical studies are applied.

Several sources of information for estimating land use water quality are available. National average pollutant concentrations for land use types were estimated in Nationwide Urban Runoff Program's Final Report published in 1983 (US EPA, 1983). More recently, a number of municipalities have conducted stormwater monitoring programs including Ventura County and LA County, which has conducted stormwater-monitoring programs since 1996. Because of there extensive databases, pollutant EMCs for each land use type were estimated from the monitoring data collected by the LA County and Ventura County Stormwater Monitoring Programs.

#### **B-3.2.1 LA County Stormwater Monitoring Program**

The Los Angeles County Stormwater Monitoring Program was initiated with the goal of providing technical data and information to support effective watershed stormwater quality management programs in Los Angeles County. Specific objectives of this project included monitoring and assessing pollutant concentrations from specific land uses and watershed areas. In order to achieve this objective, the County undertook an extensive stormwater sampling project that included 7 land use stations and 5 mass emission stations, which were tested for 82 water quality parameters. These data were published in the *Los Angeles County 1994-2000 Integrated Receiving Water Impacts Report* (Los Angeles County Department of Public Works, 2000a).

The land use monitoring stations capture runoff from smaller watersheds (0.1 to 1 square mile) with relatively homogeneous land use, Mass Emission Stations monitored runoff from major drainage areas near their outfall to the ocean. At both of these station types, flows were measured and automated samplers were installed to collect and composite stormwater

samples during storm events. For the purposes of modeling, only the data from the land use monitoring sites were utilized. Furthermore only data from developed land uses that were similar to the uses anticipated for the proposed development were selected to the extent possible (i.e. data from stormwater monitoring of a commercial site by LA County is used to represent stormwater concentrations from commercial areas within the proposed development). A description of the land use stations monitored in the LA County program of which land use EMC data were utilized in the model and the years monitored by water year are provided in Table B-1.

**Table B-1: Land Use Stations Monitored in the LA County Monitoring Program**

<b>Station Name</b>	<b>Station ID</b>	<b>Modeled Land Use</b>	<b>Site Description</b>	<b>Monitoring Years</b>
Santa Monica Pier	S08	Commercial	The monitoring site is located near intersection of Appian Way and Moss Avenue in Santa Monica. The storm drain discharges below the Santa Monica Pier. Catchment area is approximately 81 acres. The Santa Monica Mall and Third St. Promenade dominate the watershed with remaining land uses consisting of office buildings, small shops, restaurants, hotels and high-density apartments.	1996-1999
Sawpit Creek	S11	Open Space (Vacant)	Located in Los Angeles River watershed in City of Monrovia. The monitoring station is Sawpit Creek, downstream of Monrovia Creek. Sawpit Creek is a natural watercourse at this location. Catchment area is approximately 3300 acres.	1996-2000
Project 620	S18	Single Family Residential	Located in the Los Angeles River watershed in the City of Glendale. The monitoring station is at the intersection of Glenwood Road and Cleveland Avenue. Land use is predominantly high-density, single-family residential. Catchment area is approximately 120 acres.	1996-2000
Dominguez Channel	S23	Freeway	Located within the Dominguez Channel/Los Angeles Harbor watershed in Lennox, near LAX. The monitoring station is near the intersection of 116th Street and Isis Avenue. Land use is predominantly transportation and includes areas of LAX and Interstate 105.	1996-2000
Project 1202	S24	Industrial	Located in the Dominguez Channel / Los Angeles Harbor Watershed in the City of Carson. The monitoring station is near the intersection of Wilmington Avenue and 220th Street. The overall watershed land use is predominantly industrial.	1996-2000

<b>Station Name</b>	<b>Station ID</b>	<b>Modeled Land Use</b>	<b>Site Description</b>	<b>Monitoring Years</b>
Project 474	S25	Education	Located in Los Angeles River watershed in the Northridge section of the City of Los Angeles. The monitoring station is located along Lindley Avenue, one block south of Nordoff Street. The station monitors runoff from the California State University of Northridge. Catchment area is approximately 262 acres.	1997-2000
Project 404	S26	Multi-Family Residential	Located in Los Angeles River watershed in City of Arcadia. The monitoring station is located along Duarte Road, between Holly Ave and La Cadena Ave. Catchment area is approximately 214 acres.	1997-2000
Project 156	S27	Mixed Residential	Located within the Los Angeles Watershed in the City of Glendale. The station is located along Wilson Avenue, near the intersection of Concord Street and Wilson Avenue. The land use of the drainage area is classified as mixed residential.	1997-2000

Source: Los Angeles County 1999-2000 Draft Stormwater Monitoring Report (Los Angeles County Department of Public Works, 2000)

### **B-3.2.2 Ventura County Monitoring Program**

As part of its NPDES permit, the Ventura County Flood Control District conducts storm water monitoring to determine water quality of stormwater runoff from areas with specific land uses, including agriculture. These data were published in the *Ventura Countywide Stormwater Monitoring Reports* (Ventura County Flood Control Department, November 1997; November 1998; November 1999 and July 2001).

These sites include the Wood Road at Revolon Slough Station (A-1). The watershed for this site is approximately 350 acres, and is located in Oxnard, Ventura County. The watershed is located in the flat coastal plain. The monitoring station is located in-stream, on Revolon Channel just downstream of Laguna Road. The drainage area land use is primarily row crops, including strawberries that incorporate plastic sheeting mulch. The watershed contains a small number of farm residences and ancillary farm facilities for equipment maintenance and storage. With regard to irrigation practices, sprinklers are used for plant establishment; once the plants are established, farmers switch to drip irrigation. Plastic cover is utilized during certain life stages of some crops, namely strawberries.

Stormwater samples were collected as either grab samples or flow-weighted composite samples. The water quality data from water years 1996/97, 1997/98, 1998/99, and 2000/01, were available for the Wood Road site. During this period 9 grab samples and 10 flow-weighted composite samples were obtained during runoff events. The data from the flow-weighted composite samples were used to determine model input concentrations (i.e. station average concentrations), as these are more appropriate for estimating pollutant loads from the nurseries.

### **B-3.2.3 Statistical Analysis**

Data analysis conducted by Los Angeles County substituted values equal to half the laboratory detection limit in order to estimate descriptive statistics (e.g. mean and standard deviation) for event mean concentrations (EMCs) for each monitored pollutant at each land use monitoring station. These summarized data are reported in Table 4-12 of the *Los Angeles County 1994-2000 Integrated Receiving Water Impacts Report*. While substituting half the detection limit is a common practice due to its ease of implementation, this method is known to introduce bias into the estimates for both the mean and standard deviation (Singh et al. 1997).

Previous studies have suggested that stormwater pollutant runoff concentrations tend to be logarithmically distributed. If the distribution of a data set is known, values below the detection limit can be estimated using a maximum likelihood estimator (Helsel and Hirsh 1993). For this evaluation, the individual event mean concentrations (raw data) for each of the land use monitoring sites in Table B-1 were obtained from the Los Angeles Department of Public Works Watershed Management Division/NPDES Section.



Detection limits for the modeled pollutants are shown in Table B-2. In an effort to derive more robust estimates of EMCs for the modeled pollutants, a maximum likelihood estimator method was used to analyze the monitoring data. This method ranks the log-transformed data above the detection limit, arbitrarily assigns ranks to the below the detection limit data, and extrapolates to estimate probable values of data below the detection limit using the Cunnane plotting position formula<sup>1</sup>. These values are then used with the detect data to estimate the descriptive statistics. As described in the *Los Angeles County 1994-2000 Integrated Receiving Water Impacts Report*, the majority of pollutants from the monitored land uses are best characterized with a lognormal distribution, so all data sets were analyzed assuming the lognormal distribution. Using this assumption, the probability of a concentration value occurring can be assigned to each event in the log-converted data set (including the non-detect values). If the probability of the pollutant concentration occurring is plotted against the log of the concentration for the events above the detection limit (based on the probabilities assigned using the entire data set), a line can be fit to the data above the detection limit and the slope and intercept can be calculated. The slope corresponds to the standard deviation of the data set and intercept corresponds to the median. From these parameters station mean concentrations can be calculated using the statistical relationships between central tendency and error that exist for log-converted data. A mean calculated in this manner would take into account the non-detect values as if each was assigned an actual value based on the distribution of the data set. Again, from the calculated log transformed data means and variances, the population arithmetic means and arithmetic standard deviations can be calculated for each of the parameters.

Table B-3 provides a summary of the mean stormwater runoff pollutant concentrations calculated from the land use stations from the LA County stormwater monitoring data. Table B-4 provides the estimated coefficient of variation for the modeled parameters and land uses. These values represent the summarized data from all of the sampling events for each station, which were log transformed and adjusted for non-detects as described earlier.

---

<sup>1</sup> The Cunnane plotting position formula is  $p=r - a / (n + 1 - 2a)$ , where  $a = 0.4$ ,  $p$  is the probability or plotting position,  $r$  is the rank, and  $n$  is the total number of data points, both above and below the detection limit.

**Table B-2: Monitoring Data Detection Limits and % of Detects for Modeled Parameters & Land Uses**

Constituents	TSS	TP	Diss. P	Nitrite-N	Nitrate-N	TKN	Total Al	Diss.Cd	Diss. Cu	Tot Cu	Diss. Pb	Tot. Pb	Diss. Zn	Tot. Zn
Land Use / DL	2 mg/L	0.05 mg/L	0.05 mg/L	0.03 mg/L	0.1 mg/L	0.1 mg/L	100 ug/L	1 ug/L	5 ug/L	5 ug/L	5 ug/L	5 ug/L	50 ug/L	50 ug/L
Transportation <sup>1</sup>	100%	99%	96%	87%	47%	100%	87%	14%	100%	100%	9%	49%	90%	100%
Light Industrial <sup>1</sup>	100%	95%	91%	84%	55%	100%	86%	6%	89%	100%	11%	43%	80%	98%
Mixed Residential <sup>1</sup>	98%	98%	96%	86%	53%	98%	82%	4%	68%	96%	9%	26%	57%	91%
MF Residential <sup>1</sup>	98%	97%	97%	76%	65%	100%	80%	2%	57%	93%	7%	24%	59%	89%
Educational <sup>1</sup>	100%	100%	98%	71%	53%	100%	93%	9%	81%	100%	4%	45%	15%	54%
HDSF Residential <sup>1</sup>	98%	100%	100%	65%	40%	100%	80%	2%	60%	95%	10%	38%	88%	100%
Commercial <sup>1</sup>	100%	97%	97%	79%	48%	97%	76%	13%	88%	100%	17%	8%	4%	13%
Vacant <sup>1</sup>	98%	48%	100%	30%	88%	100%	63%	0%	2%	56%	0%	100%	90%	100%
Crops <sup>2</sup>	100%	100%	70%	NA <sup>3</sup>	100%	100%	NA <sup>3</sup>	70%	100%	100%	60%	42%	92%	100%

Notes:

- (1) Data taken from LA County database
- (2) Data taken from Ventura County database
- (3) NA- Not analyzed

**Table B-3: Estimated Arithmetic Mean EMC Values for Modeled Parameters & Land Uses**

Constituents	TSS	TP	Diss. P	Nitrite-N	Nitrate-N	TKN	Total Al	Diss. Cd	Diss. Cu	Tot Cu	Diss. Pb	Tot Pb	Diss Zn	Tot Zn
Land Use / Units	mg/L	mg/L	mg/L	mg/L	mg/L	mg/L	ug/L	ug/L	ug/L	ug/L	ug/L	ug/L	ug/L	ug/L
Transportation <sup>1</sup>	39	0.3	0.25	0.05	0.33	1.05	250	1.94	24.3	34	0.52	3.52	129	173
Light Industrial <sup>1</sup>	178	0.31	0.2	0.07	0.61	2.28	837	0.36	17.1	28	8.38	18.16	267	335
Mixed Residential <sup>1</sup>	73	0.28	0.23	0.13	0.59	2.23	278	0.06	8.6	13	1.6	5.22	98	134
MF Residential <sup>1</sup>	40	0.24	0.2	0.11	1.36	1.81	286	0.05 <sup>5</sup>	6.36	11	1.01	3.25	61	97
Educational <sup>1</sup>	94	0.3	0.26	0.09	0.58	1.59	707	0.36	9.9	16	0.47	2.92	67	97
HDSF Residential <sup>1</sup>	120	0.41	0.32	0.09	0.79	2.99	570	0.05	9.51	16	5.13	8.76	31	73
Commercial <sup>1</sup>	68	0.4	0.4	0.15	0.55	3.11	1933	0.66	14.5	35	4.9	20.81	157	239
Vacant <sup>1</sup>	224	0.12	0.09	0.03	1.16	0.98	679	0.05	2.5 <sup>6</sup>	9	1.25 <sup>7</sup>	3.21 <sup>8</sup>	37	22
Crops <sup>2</sup>	1397	2.74	2.74 <sup>3</sup>	0.026 <sup>4</sup>	12.32	8.07	NA <sup>9</sup>	1.9	29	133	18.41	49.12	38	332

Notes:

- (1) Data taken from LA County database
- (2) Data taken from Ventura County database
- (3) Estimates for dissolved phosphorous were higher than for total phosphorus due to larger variation. The EMC for dissolved phosphorus was set equal to the total phosphorus value
- (4) Nitrite was not monitored by Ventura County for the row crops; the EMC was set equal to the open space EMC due to the lack of monitoring data.
- (5) There was only one detect for dissolved cadmium for MF Residential and HDSF Residential land uses and none for vacant land use. Hence, the dissolved Cd value was set to ½ of the detection limit due to lack of data.
- (6) There was only one detect for dissolved copper for open space land use, the value was set to half the detection limit due to the lack of data.
- (7) There were no detects for dissolved lead for open space land use; the value was set to ½ of the detection limit due to the lack of data.
- (8) One data point with a value of 113 ug/L was eliminated as an outlying value
- (9) NA- Not analyzed

**Table B-4: Estimated Coefficient of Variation for Modeled Parameters & Land Uses**

Constituents	TSS	TP	Diss. P	Nitrite-N	Nitrate-N	TKN	Total Al	Diss. Cd	Diss Cu	Tot Cu	Diss Pb	Tot Pb	Diss Zn	Tot Zn
Land Use / Units	mg/L	mg/L	mg/L	mg/L	mg/L	mg/L	ug/L	ug/L	ug/L	ug/L	ug/L	ug/L	ug/L	ug/L
Transportation <sup>1</sup>	0.7	0.6	0.7	0.5	0.9	0.4	0.8	0.2	0.4	0.3	4.1	1.4	0.6	0.4
Light Industrial <sup>1</sup>	0.8	0.9	0.8	0.7	1	0.7	2	10.2	1	0.8	3.1	4.4	0.7	0.5
Mixed Residential <sup>1</sup>	1.2	0.9	0.8	1.3	0.7	0.8	1.2	9.5	0.8	0.5	22	1.6	0.7	0.5
MF Residential <sup>1</sup>	1.3	0.9	1	1.8	0.9	0.7	0.9	NE <sup>4</sup>	0.7	0.4	6.7	1.8	0.9	0.5
Educational <sup>1</sup>	1.2	0.6	0.8	1.6	0.7	0.6	1	0.9	0.7	0.4	36.5	1.3	0.6	0.5
HDSF Residential <sup>1</sup>	1.3	0.8	0.7	1.9	2.2	0.9	2.1	NE <sup>4</sup>	1	0.6	1.3	1.5	3.7	0.8
Commercial <sup>1</sup>	0.7	0.8	0.8	1.7	0.7	1	6.4	0.5	0.9	0.9	6.1	8.1	0.7	0.6
Vacant <sup>1</sup>	7	3.3	15.9	0.4	0.6	1	4	NE <sup>4</sup>	2.1	2	NE <sup>4</sup>	0.4	0.5	5.1
Crops <sup>2</sup>	1.3	0.4	3.4	NA <sup>3</sup>	0.9	0.6	NA <sup>3</sup>	2	1.1	0.7	3.4	0.8	0.9	0.5

Notes:

- (1) Data taken from LA County database
- (2) Data taken from Ventura County database
- (3) NA- Not analyzed
- (4) NE - Not estimated due to lack of data

### **B-3.3 Average Annual Runoff Volume**

Average annual runoff volumes were modeled using EPA's Storm Water Management Model (SWMM). Runoff volumes were modeled for each land use within each catchment. A detailed description of the methodology, data needs and data sources of SWMM are provided in Appendix A.

### **B-3.4 BMP Effluent Quality**

Various data sources were examined to estimate the anticipated performance of the proposed BMPs, including the American Society of Civil Engineers (ASCE) and EPA database recently compiled by ASCE's Urban Runoff Research Council (Strecker et al., 2001). The ASCE International Stormwater Best Management Practices Database is the most recent and robust database available to analyze the effects of a variety of BMPs on storm water quality (available at <http://www.bmpdatabase.org>). The ASCE Database contains the results of studies that have monitored the effectiveness of a variety of BMPs in treating water quality pollutants. Typical information included in each study is a description of the BMP, the drainage area with dominant land uses, influent concentrations, effluent concentrations, and removal efficiencies. BMP treatment efficiencies for the detention basins and vegetated swales are based upon the BMP water quality monitoring data included in the ASCE Database shown in Table B-5.

When there is insufficient data in the database to provide statistically reliable effluent concentrations for certain constituents (such as aluminum), the effluent quality is assumed to be equal to the influent quality (a conservative approach that assumes no treatment).

**Table B-5: BMP Performance- Modeled Effluent Concentration for Stormwater Treatment in Detention Basins and Vegetated Swales**

BMP		ASCE/EPA National BMP Effluent Quality <sup>1,2</sup>												
		TSS	Total P	Diss. P	TKN	Nitrate-N	Ammonia-N	Diss. Cd	Tot Cu	Diss. Cu	Tot Pb	Diss. Pb	Tot Zn	Diss. Zn
Detention Basin	Concentration (mg/L)	34	0.265	0.153	1.58	0.294	0.365	5.20E-04	0.016	0.016	0.019	0.003	0.078	0.055
	# of Samples	89	74	8	58	74	12	23	95	69	94	69	104	69
Vegetated Swale	Concentration (mg/L)	24	0.345	0.252	1.19	0.516	0.07	2.40E-04	0.006	0.006	0.014	0.004	0.038	0.025
	# of Samples	148	165	105	60	133	68	37	131	62	155	62	159	62

Notes:

- (1) Performance based on mean value of available ASCE database monitoring data for detention basins.
- (2) Due to sparse data in the ASCE database, effluent quality for total Al was conservatively assumed to be same as influent quality

## B-4 REFERENCES

Helsel, D.R. and R.M. Hirsch (1993). *Studies in Environmental Science 49: Statistical Methods in Water Resources*. Elsevier Science B.V., Amsterdam, The Netherlands.

Los Angeles County Department of Public Works, 2000a. Los Angeles County 1994-2000 Integrated Receiving Water Impacts Report. Prepared by Los Angeles County Department of Public Works. [http://ladpw.org/wmd/npdes/9400\\_wq\\_summaries.zip](http://ladpw.org/wmd/npdes/9400_wq_summaries.zip)

Los Angeles County Department of Public Works, 2000b. Los Angeles County 1999-2000 Draft Stormwater Monitoring Report. Prepared by Los Angeles County Department of Public Works and URS Greiner Woodward Clyde.

National Stormwater Best Management Practices Database 2000. Urban Water Resources Research Council (UWRRC) of the ASCE and USEPA

Singh, A.K., A. Singh, and M. Engelhardt (1997). "The lognormal distribution in environmental applications." EPA Technology Support Center Issue, EPA 600-R-97-006.

Strecker, E., Quigley, M.M., Urbonas, B.R., Jones, J.E., and Clary, J.K. 2001. Determining Urban Stormwater BMP Effectiveness, *Journal of Water Resources Planning and Management* May/June 2001.

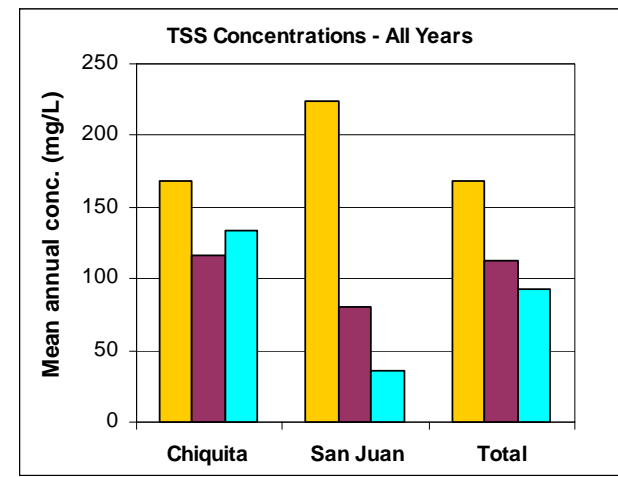
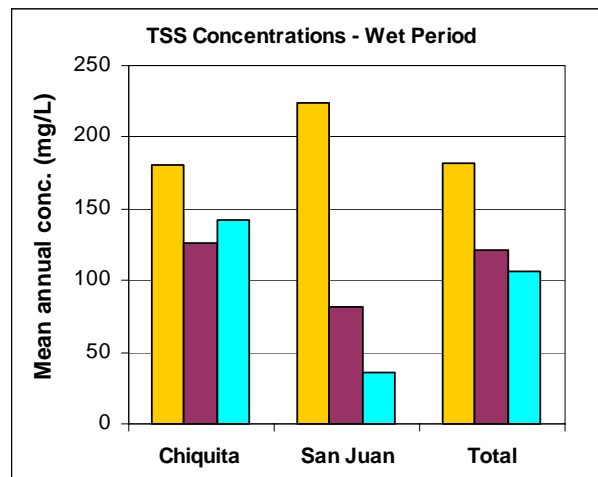
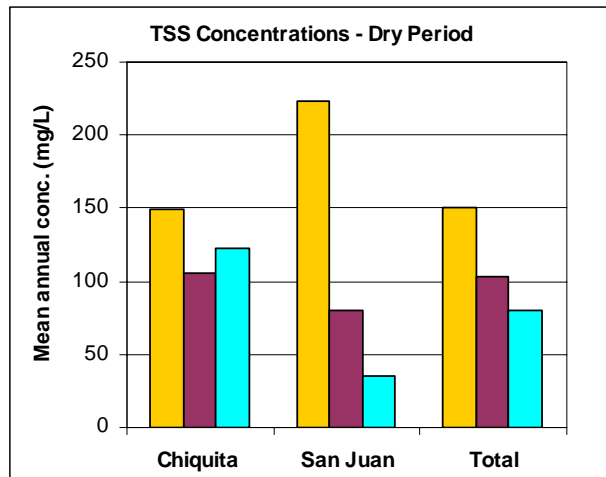
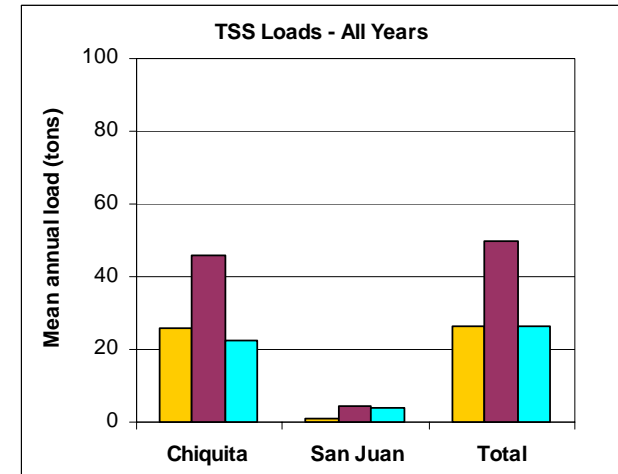
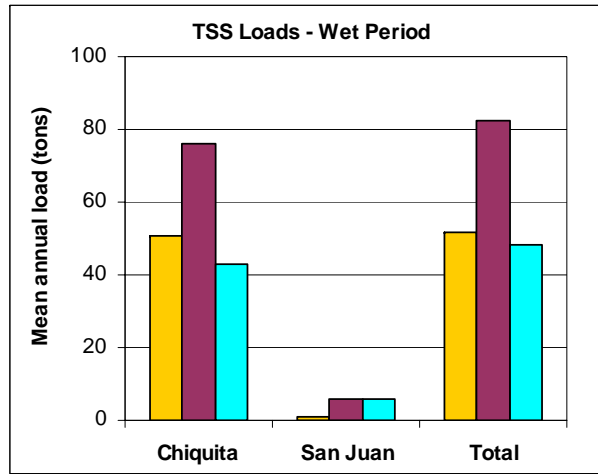
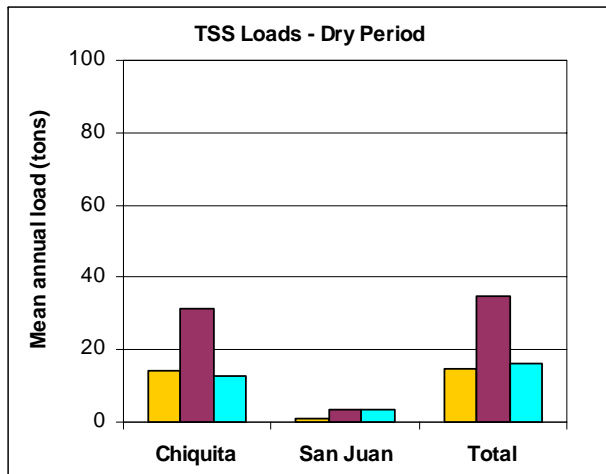
US Environmental Protection Agency (USEPA), 1983. Final Report of the Nationwide Urban Runoff Program (NURP), USEPA, Water Planning Division, Washington, DC.

Ventura County Flood Control Department (VCFCD) (July 2001). *Ventura Countywide Stormwater Monitoring Program: 2000/01 Monitoring Status Report*

Ventura County Flood Control Department (VCFCD) (November 1, 1999). *Ventura Countywide Stormwater Monitoring Program: Annual Report for Permit Year 5*

Ventura County Flood Control Department (VCFCD) (November 1, 1998). *Ventura Countywide Stormwater Monitoring Program: Annual Report for Permit Year 4*

Ventura County Flood Control Department (VCFCD) (November 1, 1997). *Ventura Countywide Stormwater Monitoring Program: Annual Report for Permit Year 3*



■ Existing  
■ Post- Developed  
■ Post- Developed w/ BMPs

**Figure B-1**  
**An Example Illustration of TSS Loads and Concentrations for Cañada Chiquita**



**Appendix C:**  
**Water Quality Monitoring Data**

Wet Weather Flows

Parameters	Sample Date	Units	San Juan Creek at Equestrian Park	San Juan Creek at Caspers	Trabuca Creek Upstream of Crown	Trabuca Creek Upstream of ATGC	Trabuca Creek Downstream of ATGC	Gobernadora Downstream of Cote De Coza	Gobernadora Upstream of Confluence with San Juan	Cristianitos Creek	Gabino Creek
4,4'-DDD	2/12/2003	ug/l	ND		ND	ND	ND	ND	ND	ND	ND
	2/25/2003	ug/l	ND	ND	ND	ND	ND	ND	ND	ND	ND
	3/15/2003	ug/l	ND	ND	ND	ND	ND	ND	ND	ND	ND
4,4'-DDE	2/12/2003	ug/l	ND		ND	ND	ND	ND	ND	ND	ND
	2/25/2003	ug/l	ND	ND	ND	ND	ND	ND	ND	ND	ND
	3/15/2003	ug/l	ND	ND	ND	ND	ND	ND	ND	ND	ND
4,4'-DDT	2/12/2003	ug/l	ND		ND	ND	ND	ND	ND	ND	ND
	2/25/2003	ug/l	ND	ND	ND	ND	ND	ND	ND	ND	ND
	3/15/2003	ug/l	ND	ND	ND	ND	ND	ND	ND	ND	ND
4-BFB (FID)	2/12/2003	ug/l	8.5		8.8	8.77	9.06	9.1	8.84	9.2	9.23
	2/25/2003	ug/l	9.96	9.72	9.62	10	8.87	8.47	8.93	8.36	8.57
	3/15/2003	ug/l	9.79	9.69	9.36	9.83	9.94	9.87	9.54	8.89	11.6
Aldrin	2/12/2003	ug/l	ND		ND	ND	ND	ND	ND	ND	ND
	2/25/2003	ug/l	ND	ND	ND	ND	ND	ND	ND	ND	ND
	3/15/2003	ug/l	ND	ND	ND	ND	ND	ND	ND	ND	ND
Alkalinity as CaCO3	11/12/2001	mg/l	220		540	220	240	290	320		
	2/17/2002	mg/l	200		170	210	200	280	280		
	2/12/2003	mg/l	130		100	120	120	120	160	ND	25
	2/25/2003	mg/l	110	110	56	39	58	90	66	30	36
	3/15/2003	mg/l	120	39	54	58	58	110	110	24	45
alpha-BHC	2/12/2003	ug/l	ND		ND	ND	ND	ND	ND	ND	ND
	2/25/2003	ug/l	ND	ND	ND	ND	ND	ND	ND	ND	ND
	3/15/2003	ug/l	ND	ND	ND	ND	ND	ND	ND	ND	ND
Ammonia-N	11/12/2001	mg/l	ND		0.74	ND	ND	ND	ND		
	2/17/2002	mg/l	ND		ND	ND	ND	ND	ND		
Antimony	2/12/2003	ug/l	0.76		0.87	0.62	0.6	0.54	0.35	0.18	0.092
	2/25/2003	ug/l	0.24	0.11	0.3	0.35	0.27	0.31	0.33	ND	0.062
	3/15/2003	ug/l	ND	ND	ND	ND	ND	ND	ND	ND	ND
Antimony, Dissolved	2/12/2003	ug/l	0.5		0.79	0.55	0.49	0.52	0.43	0.32	0.21
	3/15/2003	ug/l	ND	ND	ND	ND	ND	ND	ND	ND	ND
Arsenic	11/12/2001	mg/l	0.0039		0.026	0.0039	0.0039	0.0067	0.009		
	2/17/2002	mg/l	0.0074		0.0039	0.0039	0.0039	0.01	0.0077		
	2/12/2003	ug/l	6.4		2.7	3.4	3.5	6.6	6.8	1.8	0.77
	2/25/2003	ug/l	9	9.5	8.8	7.7	11	6.5	9.7	4.1	3.7
	3/15/2003	ug/l	24	1.5	2.7	3.5	3.5	5.2	7.6	0.29	1.6
Arsenic, Dissolved	2/12/2003	ug/l	5		1.6	1.8	2	5.2	6.1	ND	ND
	3/15/2003	ug/l	3.7	1.1	1.4	2.1	1.8	3	6.2	ND	1.1
Azinphosmethyl	2/17/2002	ug/l	ND		ND	ND	ND	ND	ND		
Barban	2/17/2002	ug/L	ND		ND	ND	ND	ND	ND		
Barium	2/12/2003	ug/l	57		50	54	52	98	59	320	600
	2/25/2003	ug/l	210	370	420	170	390	140	210	1300	520
	3/15/2003	ug/l	570	19	92	78	86	200	120	480	480
Barium, Dissolved	2/12/2003	ug/l	44		48	44	50	70	59	32	24
	3/15/2003	ug/l	21	12	19	23	20	33	35	17	15
Beryllium	2/12/2003	ug/l	ND		ND	ND	ND	0.19	ND	3.6	3.4
	2/25/2003	ug/l	1.1	1.6	1.3	0.5	1.1	0.37	1.1	4.7	2.2
	3/15/2003	ug/l	ND	ND	ND	ND	ND	1.2	1	3.2	2.4
Beryllium, Dissolved	2/12/2003	ug/l	ND		ND	ND	ND	ND	ND	0.19	ND
	3/15/2003	ug/l	ND	ND	ND	ND	ND	ND	ND	ND	ND
beta-BHC	2/12/2003	ug/l	ND		ND	ND	ND	ND	ND	ND	ND
	2/25/2003	ug/l	ND	ND	ND	ND	ND	ND	ND	ND	ND
	3/15/2003	ug/l	ND	ND	ND	ND	ND	ND	ND	ND	ND
Bolstar	2/17/2002	ug/l	ND		ND	ND	ND	ND	ND		
Boron	11/12/2001	mg/l	0.34		0.13	0.13	0.12	0.22	0.3		
	2/17/2002	mg/l	0.29		0.096	0.11	0.12	0.22	0.28		
Cadmium	11/12/2001	mg/l	ND		0.0068	ND	ND	ND	ND		
	2/17/2002	mg/l	ND		ND	ND	ND	ND	ND		
	2/12/2003	ug/l	0.22		0.094	0.16	0.098	0.044	ND	0.42	0.37
	2/25/2003	ug/l	1.4	2.1	2.2	1.4	2.4	0.1	0.23	0.96	0.77
	3/15/2003	ug/l	9.1	ND	ND	ND	ND	ND	ND	ND	ND
Cadmium, Dissolved	2/12/2003	ug/l	0.088		0.078	0.088	0.062	0.034	0.037	0.37	0.05
	3/15/2003	ug/l	ND	ND	ND	ND	ND	ND	ND	ND	ND
Calcium	11/12/2001	mg/l	160		250	130	130	140	120		
	2/17/2002	mg/l	110		88	100	100	120	110		
Carbaryl	2/17/2002	ug/L	ND		ND	ND	ND	ND	ND		
Carbofuran	2/17/2002	ug/L	ND		ND	ND	ND	ND	ND		
Chlordane	2/12/2003	ug/l	ND		ND	ND	ND	ND	ND	ND	ND
	2/25/2003	ug/l	ND	ND	ND	ND	ND	ND	ND	ND	ND
	3/15/2003	ug/l	ND	ND	ND	ND	ND	ND	ND	ND	ND
Chlorpropham	2/17/2002	ug/L	ND		ND	ND	ND	ND	ND		
Chlorpyrifos (Dursban)	2/17/2002	ug/l	ND		ND	ND	ND	ND	ND		
Chromium	11/12/2001	mg/l	ND		0.04	0.038	ND	ND	ND		
	2/17/2002	mg/l	ND		ND	ND	ND	0.005	0.0067		
	2/12/2003	ug/l	1		ND	0.3	ND	2.6	ND	40	68
	2/25/2003	ug/l	5.7	61	20	18	35	4.9	8.9	110	85
	3/15/2003	ug/l	99	ND	1.6	2.4	4.5	2.5	1.8	11	16

Wet Weather Flows (Continued)

Parameters	Sample Date	Units	San Juan Creek at Equestrian Park	San Juan Creek at Caspers	Trabuca Creek Upstream of Crown	Trabuca Creek Upstream of ATGC	Trabuca Creek Downstream of ATGC	Gobernadora Downstream of Cote De Coza	Gobernadora Upstream of Confluence with San Juan	Cristianitos Creek	Gabino Creek
Chromium, Dissolved	2/12/2003	ug/l	0.34		0.44	0.22	0.24	1.3	0.36	0.52	0.79
	3/15/2003	ug/l	ND	ND	ND	ND	ND	ND	ND	ND	1
Cobalt	2/12/2003	ug/l	0.79		0.28	0.53	0.25	1.4	0.36	23	23
	2/25/2003	ug/l	6.5	26	12	6.2	13	2.5	6.3	45	35
	3/15/2003	ug/l	30	ND	2.3	1.9	2.5	4.2	3.2	21	28
Cobalt, Dissolved	2/12/2003	ug/l	0.3		0.18	0.2	0.18	0.28	0.24	6.6	0.15
	3/15/2003	ug/l	ND	ND	ND	ND	ND	ND	ND	ND	ND
Copper	11/12/2001	mg/l	ND		0.1	ND	ND	ND	ND		
	2/17/2002	mg/l	0.014		ND	ND	ND	ND	ND		
	2/12/2003	ug/l	5.3		4.2	4.1	2.7	6.3	3	38	58
	2/25/2003	ug/l	16	55	39	23	43	9.2	16	81	70
Copper, Dissolved	3/15/2003	ug/l	90	2.1	12	9.9	12	9.3	6.2	25	36
	2/12/2003	ug/l	3.4		3.5	2.7	2.7	4	2.6	1.3	3.5
	3/15/2003	ug/l	3.7	2.1	3.3	3.7	2.5	2.5	2.1	4.5	4.7
Counaphos	2/17/2002	ug/l	ND		ND	ND	ND	ND	ND		
	2/12/2003	ug/l	0.032		0.393	0.539	0.401	0.419	0.337	0.237	0.355
	2/25/2003	ug/l	0.402	0.373	0.423	0.425	0.436	0.401	0.412	0.412	0.424
Def/Merphos	3/15/2003	ug/l	0.285	0.343	0.311	0.339	0.313	0.324	0.323	0.324	0.273
	2/17/2002	ug/l	ND		ND	ND	ND	ND	ND		
	2/12/2003	ug/l	ND		ND	ND	ND	ND	ND	ND	ND
delta-BHC	2/25/2003	ug/l	ND	ND	ND	ND	ND	ND	ND	ND	ND
	3/15/2003	ug/l	ND	ND	ND	ND	ND	ND	ND	ND	ND
	2/17/2002	ug/l	ND		ND	ND	ND	ND	ND	ND	ND
Demeton (Total)	2/17/2002	ug/l	ND		ND	ND	ND	ND	ND	ND	ND
Diazinon	2/17/2002	ug/l	ND		ND	ND	0.12	ND	ND		
Dichlorvos	2/17/2002	ug/l	ND		ND	ND	ND	ND	ND		
Dieldrin	2/12/2003	ug/l	ND		ND	ND	ND	ND	ND	ND	ND
	2/25/2003	ug/l	ND	ND	ND	ND	ND	ND	ND	ND	ND
	3/15/2003	ug/l	ND	ND	ND	ND	ND	ND	ND	ND	ND
Dimethoate	2/17/2002	ug/l	ND		ND	ND	ND	ND	ND		
Dissolved Organic Carbon	2/12/2003	mg/l	14		6.2	12	9.3	13	16	9.6	12
	2/25/2003	mg/l	12	19	7.7	7.1	9.2	15	14	16	19
	3/15/2003	mg/l	9.2	4.9	6.4	8.6	6.5	8.2	9.4	19	21
Disulfoton	2/17/2002	ug/l	ND		ND	ND	ND	ND	ND		
Diuron	2/17/2002	ug/L	ND		ND	ND	ND	ND	ND		
Endosulfan I	2/12/2003	ug/l	ND		ND	ND	ND	ND	ND	ND	ND
	2/25/2003	ug/l	ND	ND	ND	ND	ND	ND	ND	ND	ND
	3/15/2003	ug/l	ND	ND	ND	ND	ND	ND	ND	ND	ND
Endosulfan II	2/12/2003	ug/l	ND		ND	ND	ND	ND	ND	ND	ND
	2/25/2003	ug/l	ND	ND	ND	ND	ND	ND	ND	ND	ND
	3/15/2003	ug/l	ND	ND	ND	ND	ND	ND	ND	ND	ND
Endosulfan sulfate	2/12/2003	ug/l	ND		ND	ND	ND	ND	ND	ND	ND
	2/25/2003	ug/l	ND	ND	ND	ND	ND	ND	ND	ND	ND
	3/15/2003	ug/l	ND	ND	ND	ND	ND	ND	ND	ND	ND
Endrin	2/12/2003	ug/l	ND		ND	ND	ND	ND	ND	ND	ND
	2/25/2003	ug/l	ND	ND	ND	ND	ND	ND	ND	ND	ND
	3/15/2003	ug/l	ND	ND	ND	ND	ND	ND	ND	ND	ND
Endrin aldehyde	2/12/2003	ug/l	ND		ND	ND	ND	ND	ND	ND	ND
	2/25/2003	ug/l	ND	ND	ND	ND	ND	ND	ND	ND	ND
	3/15/2003	ug/l	ND	ND	ND	ND	ND	ND	ND	ND	ND
Endrin ketone	2/12/2003	ug/l	ND		ND	ND	ND	ND	ND	ND	ND
	2/25/2003	ug/l	ND	ND	ND	ND	ND	ND	ND	ND	ND
	3/15/2003	ug/l	ND	ND	ND	ND	ND	ND	ND	ND	ND
EPN	2/17/2002	ug/l	ND		ND	ND	ND	ND	ND		
EPTC	2/17/2002	ug/l	ND		ND	ND	ND	ND	ND		
Ethion	2/17/2002	ug/l	ND		ND	ND	ND	ND	ND		
Ethoprop	2/17/2002	ug/l	ND		ND	ND	ND	ND	ND		
Fecal Coliform Group Bacteria	2/12/2003	MPN/100ml	800		900	7000	16000	1700	5000	5000	300
	2/13/2003	MPN/100ml	8000					13000		8000	
	2/25/2003	MPN/100ml	9000	8000	8000	24000	58000	28000	13000	47000	24000
	3/15/2003	MPN/100ml	3000	800	5000	>16000	>16000	>16000	9000	>16000	>16000
	3/16/2003	MPN/100ml								>16000	
Fensulfthion	2/17/2002	ug/l	ND		ND	ND	ND	ND	ND		
Fenthion	2/17/2002	ug/l	ND		ND	ND	ND	ND	ND		
Fenuron	2/17/2002	ug/L	ND		ND	ND	ND	ND	ND		
Fluometuron	2/17/2002	ug/L	ND		ND	ND	ND	ND	ND		
gamma-BHC (Lindane)	2/12/2003	ug/l	ND		ND	ND	ND	ND	ND	ND	ND
	2/25/2003	ug/l	ND	ND	ND	ND	ND	ND	ND	ND	ND
	3/15/2003	ug/l	ND	ND	ND	ND	ND	ND	ND	ND	ND
Hardness (as CaCO3)	2/12/2003	mg/l	230		180	210	240	220	210	140	170
	2/25/2003	mg/l	170	180	150	100	140	160	120	220	140
	3/15/2003	mg/l	290	55	100	110	120	120	180	150	180
Heptachlor	2/12/2003	ug/l	ND		ND	ND	ND	ND	ND	ND	ND
	2/25/2003	ug/l	ND	ND	ND	ND	ND	ND	ND	ND	ND
	3/15/2003	ug/l	ND	ND	ND	ND	ND	ND	ND	ND	ND
Heptachlor epoxide	2/12/2003	ug/l	ND		ND	ND	ND	ND	ND	ND	ND
	2/25/2003	ug/l	ND	ND	ND	ND	ND	ND	ND	ND	ND
	3/15/2003	ug/l	ND	ND	ND	ND	ND	ND	ND	ND	ND

Wet Weather Flows (Continued)

Parameters	Sample Date	Units	San Juan Creek at Equestrian Park	San Juan Creek at Caspers	Trabuca Creek Upstream of Crown	Trabuca Creek Upstream of ATGC	Trabuca Creek Downstream of ATGC	Gobernadora Downstream of Cote De Coza	Gobernadora Upstream of Confluence with San Juan	Cristianitos Creek	Gabino Creek
Lead	11/12/2001	mg/l	ND		0.02	ND	ND	ND	ND		
	2/17/2002	mg/l	ND		ND	ND	ND	ND	ND		
	2/12/2003	ug/l	0.9		0.32	0.48	0.16	1.8	0.32	37	56
	2/25/2003	ug/l	10	33	17	8	18	7.2	19	85	41
	3/15/2003	ug/l	22	ND	3.8	3.3	3.3	7.1	5.5	14	20
Lead, Dissolved	2/12/2003	ug/l	ND		ND	ND	0.13	3.9	ND	ND	0.19
	3/15/2003	ug/l	ND	ND	ND	ND	ND	ND	ND	ND	ND
Lihuron	2/17/2002	ug/L	ND		ND	ND	ND	ND	ND		
Magnesium	11/12/2001	mg/l	39		31	32	30	24	22		
	2/17/2002	mg/l	25		20		26	21	20		
Malathion	2/17/2002	ug/l	ND			ND	ND	ND	ND		
Mercury	11/12/2001	mg/l	ND		ND	ND	ND	ND	ND		
	2/17/2002	mg/l	ND		ND	ND	ND	ND	ND		
	2/12/2003	mg/l	ND		ND	ND	ND	ND	ND	ND	ND
	2/25/2003	mg/l	ND	0.00011	ND	ND	ND	ND	ND	ND	ND
	3/15/2003	mg/l	ND	ND	ND	ND	ND	ND	ND	ND	ND
Mercury, Dissolved	2/12/2003	mg/l	ND		ND	ND	ND	ND	ND	ND	ND
	2/25/2003	mg/l	ND	ND	ND	ND	ND	ND	ND	ND	ND
	3/15/2003	mg/l	ND	ND	ND	ND	ND	ND	ND	ND	ND
Methomyl	2/17/2002	ug/L	ND		ND	ND	ND	ND	ND		
Methoxychlor	2/12/2003	ug/l	ND		ND	ND	ND	ND	ND	ND	ND
	2/25/2003	ug/l	ND	ND	ND	ND	ND	ND	ND	ND	ND
	3/15/2003	ug/l	ND	ND	ND	ND	ND	ND	ND	ND	ND
Mevinphos	2/17/2002	ug/l	ND			ND	ND	ND	ND		
Molybdenum	2/12/2003	ug/l	5.2		4.8	5.1	6.4	2.6	3.8	0.34	0.12
	2/25/2003	ug/l	1.5	1.1	1.5	2.9	2.5	2.5	1.4	0.26	0.14
	3/15/2003	ug/l	14	2	ND	1.3	1.5	ND	ND	ND	ND
Molybdenum, Dissolved	2/12/2003	ug/l	5.2		5.1	6	6.8	3	3.9	ND	0.5
	3/15/2003	ug/l	18	3	1.9	3	3.1	1.2	2.1	ND	ND
Monuron	2/17/2002	ug/L	ND		ND	ND	ND	ND	ND		
Naled	2/17/2002	ug/l	ND			ND	ND	ND	ND		
Neburon	2/17/2002	ug/L	ND		ND	ND	ND	ND	ND		
Nickel	2/12/2003	ug/l	2.5		1.1	2	0.86	2.1	0.92	31	36
	2/25/2003	ug/l	11	43	21	16	29	4.2	7.7	61	50
	3/15/2003	ug/l	93	1.2	4.7	4.8	7.1	5.2	4.2	21	25
Nickel, Dissolved	2/12/2003	ug/l	1.4		1.1	1.6	1.3	1.3	1	9.6	2
	3/15/2003	ug/l	2.9	ND	1.4	1.8	1.8	1.1	1.3	3.8	2.4
Nitrate-N	2/12/2003	mg/l	1.5		1.3	0.88	0.65	1.1	0.58	0.94	0.29
	2/25/2003	mg/l	0.46	1.4	0.51	0.37	0.45	0.89	0.6	0.63	1.1
	3/15/2003	mg/l	1.5	0.15	0.71	0.72	0.56	0.58	0.44	0.32	0.4
Nitrate-NO3	11/12/2001	mg/l	17		8.3	1.2	ND	2.9	2.9		
	2/17/2002	mg/l	12		3.8	ND	ND	0.57	0.92		
Nitrite-N	2/12/2003	mg/l	ND		0.15	ND	ND	0.15	ND	ND	ND
	2/25/2003	mg/l	ND	0.16	ND	ND	ND	ND	ND	ND	ND
	3/15/2003	mg/l	ND	ND	ND	ND	ND	ND	ND	ND	ND
Oil & Grease	2/12/2003	mg/l	11		ND	ND	ND	ND	ND	ND	ND
	2/25/2003	mg/l	ND	4.9	ND	ND	ND	ND	ND	7.4	ND
	3/15/2003	mg/l	ND	ND	ND	ND	ND	ND	ND	ND	ND
Orthophosphate	11/12/2001	mg/l	ND		ND	ND	ND	ND	ND		
	2/17/2002	mg/l	ND		ND	ND	ND	ND	ND		
Orthophosphate - P	2/12/2003	mg/l	0.54		0.14	0.18	0.11	0.5	0.43	0.34	0.33
	2/25/2003	mg/l	0.76	1.1	0.67	0.46	0.72	0.77	1	ND	ND
	3/15/2003	mg/l	0.6	0.11	0.24	0.27	0.26	0.48	0.43	0.059	0.089
Oxaryl	2/17/2002	ug/L	ND		ND	ND	ND	ND	ND		
Parathion, ethyl	2/17/2002	ug/l	ND			ND	ND	ND	ND		
Parathion, methyl	2/17/2002	ug/l	ND			ND	ND	ND	ND		
pH	2/17/2002	pH Units	7.92		8.1	7.98	8.04	7.96	8.15		
Phorate	2/17/2002	ug/l	ND			ND	ND	ND	ND		
Phosphorus	2/12/2003	mg/l	0.07		0.14	0.16	0.029	0.49	0.38	0.39	0.42
	2/25/2003	mg/l	1.5	3	1.5	0.84	1.3	0.86	1.3	1.2	0.94
	3/15/2003	mg/l	1.3	ND	0.48	0.37	0.42	1.1	0.82	0.6	0.56
Propham	2/17/2002	ug/L	ND		ND	ND	ND	ND	ND		
Propoxur	2/17/2002	ug/L	ND		ND	ND	ND	ND	ND		
Row I (Pendimethalin)	2/17/2002	ug/l	ND			ND	ND	ND	ND		
Ronnel	2/17/2002	ug/l	ND			ND	ND	ND	ND		
Selenium	11/12/2001	mg/l	ND		0.01	ND	ND	ND	ND		
	2/17/2002	mg/l	0.0051		ND	ND	ND	ND	ND		
	2/12/2003	ug/l	0.73		0.99	1	1.2	ND	ND	5	2.8
	2/25/2003	ug/l	0.71		1.2	0.83	1.5	ND	0.72	2.8	1.3
	3/15/2003	ug/l	ND	ND	ND	ND	ND	ND	ND	ND	ND
Selenium, Dissolved	2/12/2003	ug/l	0.61		1.2	1.1	1.2	ND	ND	ND	0.86
	3/15/2003	ug/l	2.1	ND	ND	ND	ND	ND	ND	ND	ND
Siduron	2/17/2002	ug/L	ND		ND	ND	ND	ND	ND		
Silver	11/12/2001	mg/l	ND		ND	ND	ND	ND	ND		
	2/17/2002	mg/l	ND		ND	ND	ND	ND	ND		
	2/12/2003	ug/l	ND		ND	ND	ND	ND	ND	0.26	0.29
	2/25/2003	ug/l	ND	0.31	0.15	0.15	0.3	ND	0.066	0.52	0.42
	3/15/2003	ug/l	ND	ND	ND	ND	ND	ND	ND	ND	ND

Wet Weather Flows (Continued)

Parameters	Sample Date	Units	San Juan Creek at Equestrian Park	San Juan Creek at Caspers	Trabuca Creek Upstream of Crown	Trabuca Creek Upstream of ATGC	Trabuca Creek Downstream of ATGC	Gobernadora Downstream of Cote De Coza	Gobernadora Upstream of Confluence with San Juan	Cristianitos Creek	Gabino Creek
Silver, Dissolved	2/12/2003	ug/l	ND		ND	ND	ND	ND	ND	ND	ND
	3/15/2003	ug/l	ND	ND	ND	ND	ND	ND	ND	ND	ND
Sodium	11/12/2001	mg/l	150		62	110	100	180	190		
	2/17/2002	mg/l	110		71	84	87	160	160		
Stirophos	2/17/2002	ug/l	ND				ND	ND	ND		
Sulfate	11/12/2001	mg/l	380		150	240	240	210	210		
	2/17/2002	mg/l	230		160	200	210	150	180		
Sulfotep	2/17/2002	ug/l	ND			ND	ND	ND	ND		
Tetrachloro-m-xylene	2/12/2003	ug/l	0.0209		0.251	0.361	0.312	0.335	0.185	0.161	0.177
	2/25/2003	ug/l	0.316	0.311	0.318	0.32	0.302	0.28	0.324	0.349	0.364
	3/15/2003	ug/l	0.247	0.306	0.268	0.254	0.264	0.245	0.242	0.307	0.281
Thallium	2/12/2003	ug/l	0.12		0.093	ND	ND	ND	ND	0.77	1.4
	2/25/2003	ug/l	0.32	1.1	0.48	0.39	0.74	0.13	0.29	2.4	1.1
	3/15/2003	ug/l	ND	ND	ND	ND	ND	ND	ND	ND	ND
Thallium, Dissolved	2/12/2003	ug/l	0.13		0.12	ND	ND	ND	ND	ND	ND
	3/15/2003	ug/l	ND	ND	ND	ND	ND	ND	ND	ND	ND
Tokuthion	2/17/2002	ug/l	ND			ND	ND	ND	ND		
Total Coliform Group Bacteria	2/12/2003	MPN/100ml	16000		9000	90000	24000	5000	5000	5000	500
	2/13/2003	MPN/100ml	30000					30000		50000	
	2/25/2003	MPN/100ml	24000	50000	30000	300000	140000	240000	13000	120000	24000
	3/15/2003	MPN/100ml	>16000	1400	>16000	>16000	>16000	>16000	>16000	>16000	>16000
	3/16/2003	MPN/100ml								>16000	
Total Dissolved Solids	2/12/2003	mg/l	500		360	400	440	460	540	230	310
	2/25/2003	mg/l	390	310	210	220	280	500	350	560	440
	3/15/2003	mg/l	440	120	180	250	240	230	380	540	420
Total Kjeldahl Nitrogen	2/12/2003	mg/l	0.56		ND	ND	ND	ND	1.1	ND	0.84
	2/25/2003	mg/l	0.84	0.84	ND	ND	3.1	ND	2.2	6.2	ND
	3/15/2003	mg/l	2.8	ND	1.1	ND	1.1	0.56	0.56	1.7	2
Total Suspended Solids	11/12/2001	mg/l	43		4200	31	ND	58	19		
	2/17/2002	mg/l	ND		ND	ND	ND	ND	ND		
	2/12/2003	mg/l	13		ND	74	ND	180	ND	6000	5600
	2/25/2003	mg/l	1400	2700	3000	680	1500	290	820	9400	3900
	3/15/2003	mg/l	3100	44	660	380	480	1300	1300	5800	4800
Toxaphene	2/12/2003	ug/l	ND		ND	ND	ND	ND	ND	ND	ND
	2/25/2003	ug/l	ND	ND	ND	ND	ND	ND	ND	ND	ND
	3/15/2003	ug/l	ND	ND	ND	ND	ND	ND	ND	ND	ND
Trichloronate	2/17/2002	ug/l	ND			ND	ND	ND	ND		
Trifluralin	2/17/2002	ug/l	ND			ND	ND	ND	ND		
Vanadium	2/12/2003	ug/l	7.4		4.4	4.6	2.9	7.9	3	92	110
	2/25/2003	ug/l	25	100	63	40	77	12	29	200	120
	3/15/2003	ug/l	170	4.3	12	12	15	15	14	61	62
Vanadium, Dissolved	2/12/2003	ug/l	2.9		2.1	1.6	1.4	2.5	2.3	ND	ND
	3/15/2003	ug/l	5.3	1.7	3.1	3.7	2.6	3.8	6.6	ND	1.4
Volatile Fuel Hydrocarbons (C)	2/12/2003	ug/l	ND		ND	ND	ND	ND	ND	ND	10
	2/25/2003	ug/l	ND	ND	ND	10	11	11	11	14	18
	3/15/2003	ug/l	ND	ND	ND	ND	ND	ND	ND	ND	ND
Zinc	11/12/2001	mg/l	0.036		0.45	ND	ND	ND	ND		
	2/17/2002	mg/l	0.023		ND	ND	ND	ND	ND		
	2/12/2003	ug/l	16		9.1	10	6.1	21	5.3	140	210
	2/25/2003	ug/l	60	190	150	85	150	37	76	370	240
	3/15/2003	ug/l	360	ND	43	36	39	47	25	90	100
Zinc, Dissolved	2/12/2003	ug/l	13		14	10	9.3	14	15	26	8.6
	3/15/2003	ug/l	ND	ND	ND	ND	ND	ND	ND	ND	ND

Dry Weather Flows

Parameters	Sample Date	Units	San Juan Creek at Equestrian Park	Trabuca Creek Upstream of Crown	Trabuca Creek Upstream of ATGC	Trabuca Creek Downstream of ATGC	Gobernadora Downstream of Cote De Coza	Gobernadora Upstream of Confluence with San Juan
Alkalinity as CaCO3	10/3/2001	mg/l	200	200	230	250	310	340
	10/29/2001	mg/l	230	180	240	230	42	330
	9/24/2002	mg/l	230	210	260	250	360	360
Ammonia-N	10/3/2001	mg/l	0.86	ND	ND	ND	ND	ND
	10/29/2001	mg/l	ND	ND	ND	ND	ND	ND
	9/24/2002	mg/l	ND	ND	ND	ND	ND	ND
Arsenic	9/24/2002	mg/l	0.0015	0.0015	0.0015	0.0015	0.013	0.0015
Azinphos methyl	9/24/2002	ug/l	ND	ND	ND	ND	ND	ND
Barban	9/24/2002	µg/L	ND	ND	ND	ND	ND	ND
Bolstar	9/24/2002	ug/l	ND	ND	ND	ND	ND	ND
Boron	10/3/2001	mg/l	0.38	0.13	0.15	0.15	0.28	0.35
	10/29/2001	mg/l	0.31	0.11	0.13	0.13	0.24	0.31
	9/24/2002	mg/l	0.48	0.14	0.17	0.16	0.33	0.36
Cadmium	10/3/2001	mg/l	ND	ND	ND	ND	ND	ND
	10/29/2001	mg/l	ND	ND	ND	ND	ND	ND
	9/24/2002	mg/l	ND	ND	ND	ND	ND	ND
Calcium	10/3/2001	mg/l	180	120	140	140	150	130
	10/29/2001	mg/l	140	100	130	130	140	120
	9/24/2002	mg/l	160	110	140	140	150	120
Carbaryl	9/24/2002	µg/L	ND	ND	ND	ND	ND	ND
Carbofuran	9/24/2002	µg/L	ND	ND	ND	ND	ND	ND
Chloroprotham	9/24/2002	µg/L	ND	ND	ND	ND	ND	ND
Chlorpyrifos	9/24/2002	ug/l	ND	ND	ND	ND	ND	ND
Chromium	10/3/2001	mg/l	ND	ND	ND	ND	ND	ND
	10/29/2001	mg/l	ND	ND	ND	ND	ND	ND
	9/24/2002	mg/l	ND	ND	ND	ND	ND	ND
Copper	10/3/2001	mg/l	ND	ND	ND	ND	ND	ND
	10/29/2001	mg/l	ND	ND	ND	ND	ND	ND
	9/24/2002	mg/l	0.011	ND	ND	ND	ND	ND
Coumaphos	9/24/2002	ug/l	ND	ND	ND	ND	ND	ND
Demeton	9/24/2002	ug/l	ND	ND	ND	ND	ND	ND
Diazinon	9/24/2002	ug/l	ND	ND	ND	ND	ND	ND
Dichlorvos	9/24/2002	ug/l	ND	ND	ND	ND	ND	ND
Dimethoate	9/24/2002	ug/l	ND	ND	ND	ND	ND	ND
Disulfoton	9/24/2002	ug/l	ND	ND	ND	ND	ND	ND
Diuron	9/24/2002	µg/L	ND	ND	ND	ND	ND	ND
Enterococcus	9/24/2002	MPN/100ml	>2419.2	59	>2419.2	57	517	354
EPN	9/24/2002	ug/l	ND	ND	ND	ND	ND	ND
Ethion	9/24/2002	ug/l	ND	ND	ND	ND	ND	ND
Ethoprop	9/24/2002	ug/l	ND	ND	ND	ND	ND	ND
Fecal Coliform	9/24/2002	MPN/100ml	>=1600	30	>=1600	50	300	70
Fensulfothion	9/24/2002	ug/l	ND	ND	ND	ND	ND	ND
Fenthion	9/24/2002	ug/l	ND	ND	ND	ND	ND	ND
Fenuron	9/24/2002	µg/L	ND	ND	ND	ND	ND	ND
Fluometuron	9/24/2002	µg/L	ND	ND	ND	ND	ND	ND
Group Coliform	9/24/2002	MPN/100ml	>=1600	1600	>=1600	300	>=1600	1600
Lead	10/3/2001	mg/l	ND	ND	ND	ND	ND	ND
	10/29/2001	mg/l	ND	ND	ND	ND	ND	ND
	9/24/2002	mg/l	ND	ND	ND	ND	ND	ND
Linuron	9/24/2002	µg/L	ND	ND	ND	ND	ND	ND
Magnesium	10/3/2001	mg/l	44	25	33	33	25	22
	10/29/2001	mg/l	36	24	31	31	24	21
	9/24/2002	mg/l	43	26	35	34	29	21
Malathion	9/24/2002	ug/l	ND	ND	ND	ND	ND	ND
Mercury	10/3/2001	mg/l	ND	ND	ND	ND	ND	ND
	10/29/2001	mg/l	ND	ND	ND	ND	ND	ND
	9/24/2002	mg/l	ND	ND	ND	ND	ND	ND
Merphos	9/24/2002	ug/l	ND	ND	ND	ND	ND	ND
Methomyl	9/24/2002	µg/L	ND	ND	ND	ND	ND	ND

Dry Weather Flows (Continued)

Parameters	Sample Date	Units	San Juan Creek at Equestrian Park	Trabuca Creek Upstream of Crown	Trabuca Creek Upstream of ATGC	Trabuca Creek Downstream of ATGC	Gobernadora Downstream of Cote De Coza	Gobernadora Upstream of Confluence with San Juan
Mevinphos	9/24/2002	ug/l	ND	ND	ND	ND	ND	ND
Monocrotophos	9/24/2002	ug/l	ND	ND	ND	ND	ND	ND
Monuron	9/24/2002	µg/L	ND	ND	ND	ND	ND	ND
Naled	9/24/2002	ug/l	ND	ND	ND	ND	ND	ND
Neburon	9/24/2002	µg/L	ND	ND	ND	ND	ND	ND
Nitrate-NO3	10/3/2001	mg/l	76	ND	1.3	ND	ND	ND
	10/29/2001	mg/l	21	ND	ND	ND	ND	1.1
	9/24/2002	mg/l	23	ND	ND	ND	ND	ND
Orthophosphate	10/3/2001	mg/l	ND	ND	ND	ND	ND	ND
	10/29/2001	mg/l	ND	ND	ND	ND	ND	ND
	9/24/2002	mg/l	6.2	ND	ND	ND	ND	ND
Oxamyl	9/24/2002	µg/L	ND	ND	ND	ND	ND	ND
Parathion-ethyl	9/24/2002	ug/l	ND	ND	ND	ND	ND	ND
Parathion-methyl	9/24/2002	ug/l	ND	ND	ND	ND	ND	ND
pH	10/29/2001	pH Units	6.68	8.36	8.06	8.11	8.32	8.14
	9/24/2002	pH Units	7.97	8.3	8.13	8.24	8.31	8.3
Phorate	9/24/2002	ug/l	ND	ND	ND	ND	ND	ND
Propham	9/24/2002	µg/L	ND	ND	ND	ND	ND	ND
Propoxur	9/24/2002	µg/L	ND	ND	ND	ND	ND	ND
Ronnel	9/24/2002	ug/l	ND	ND	ND	ND	ND	ND
Selenium	10/3/2001	mg/l	ND	ND	ND	ND	ND	ND
	10/29/2001	mg/l	ND	ND	ND	ND	ND	ND
	9/24/2002	mg/l	ND	ND	ND	ND	ND	ND
Siduron	9/24/2002	µg/L	ND	ND	ND	ND	ND	ND
Silver	9/24/2002	mg/l	ND	ND	ND	ND	ND	ND
Sodium	10/3/2001	mg/l	150	93	110	110	200	210
	10/29/2001	mg/l	120	84	99	98	180	180
	9/24/2002	mg/l	170	99	120	120	240	220
Stirophos	9/24/2002	ug/l	ND	ND	ND	ND	ND	ND
Sulfate	10/3/2001	mg/l	410	240	280	280	230	240
	10/29/2001	mg/l	440	210	270	260	220	230
	9/24/2002	mg/l	410	190	260	260	210	210
Sulfotep	9/24/2002	ug/l	ND	ND	ND	ND	ND	ND
Thionazin	9/24/2002	ug/l	ND	ND	ND	ND	ND	ND
Tokuthion (Prothiofos)	9/24/2002	ug/l	ND	ND	ND	ND	ND	ND
Total Chlorine	10/3/2001	mg/l	ND	ND	ND	ND	ND	ND
	9/24/2002	mg/l	ND	ND	ND	ND	ND	ND
Total Suspended Solids	10/3/2001	mg/l	43	ND	29	ND	ND	ND
	10/29/2001	mg/l	16	ND	12	ND	ND	ND
	9/24/2002	mg/l	49	ND	ND	ND	ND	ND
Trichloronate	9/24/2002	ug/l	ND	ND	ND	ND	ND	ND
Triphenyl phosphate	9/24/2002	ug/l	1.36	1.4	1.08	0.339	1.28	1.1
Zinc	10/3/2001	mg/l	0.089	ND	ND	ND	ND	ND
	10/29/2001	mg/l	ND	ND	ND	ND	ND	ND
	9/24/2002	mg/l	0.029	ND	ND	ND	ND	ND

Groundwater Flows

Parameters	Sample Date	Units	Well #3	Well #9	Well #23	Well #25
1,1,1,2-Tetrachloroethane	10/5/2001	ug/l		ND	ND	ND
	3/13/2002	ug/l	ND	ND	ND	ND
1,1,1-Trichloroethane	10/5/2001	ug/l		ND	ND	ND
	3/13/2002	ug/l	ND	ND	ND	ND
1,1,2,2-Tetrachloroethane	10/5/2001	ug/l		ND	ND	ND
	3/13/2002	ug/l	ND	ND	ND	ND
1,1,2-Trichloroethane	10/5/2001	ug/l		ND	ND	ND
	3/13/2002	ug/l	ND	ND	ND	ND
1,1-Dichloroethane	10/5/2001	ug/l		ND	ND	ND
	3/13/2002	ug/l	ND	ND	ND	ND
1,1-Dichloroethene	10/5/2001	ug/l		ND	ND	ND
	3/13/2002	ug/l	ND	ND	ND	ND
1,1-Dichloropropene	10/5/2001	ug/l		ND	ND	ND
	3/13/2002	ug/l	ND	ND	ND	ND
1,2,3-Trichlorobenzene	10/5/2001	ug/l		ND	ND	ND
	3/13/2002	ug/l	ND	ND	ND	ND
1,2,3-Trichloropropane	10/5/2001	ug/l		ND	ND	ND
	3/13/2002	ug/l	ND	ND	ND	ND
1,2,4-Trichlorobenzene	10/5/2001	ug/l		ND	ND	ND
	3/13/2002	ug/l	ND	ND	ND	ND
1,2,4-Trimethylbenzene	10/5/2001	ug/l		ND	ND	ND
	3/13/2002	ug/l	ND	ND	ND	ND
1,2-Dibromo-3-chloropropane	10/5/2001	ug/l		ND	ND	ND
	3/13/2002	ug/l	ND	ND	ND	ND
1,2-Dibromoethane (EDB)	10/5/2001	ug/l		ND	ND	ND
	3/13/2002	ug/l	ND	ND	ND	ND
1,2-Dichlorobenzene	10/5/2001	ug/l		ND	ND	ND
	3/13/2002	ug/l	ND	ND	ND	ND
1,2-Dichloroethane	10/5/2001	ug/l		ND	ND	ND
	3/13/2002	ug/l	ND	ND	ND	ND
1,2-Dichloropropane	10/5/2001	ug/l		ND	ND	ND
	3/13/2002	ug/l	ND	ND	ND	ND
1,3,5-Trimethylbenzene	10/5/2001	ug/l		ND	ND	ND
	3/13/2002	ug/l	ND	ND	ND	ND
1,3-Dichlorobenzene	10/5/2001	ug/l		ND	ND	ND
	3/13/2002	ug/l	ND	ND	ND	ND
1,3-Dichloropropane	10/5/2001	ug/l		ND	ND	ND
	3/13/2002	ug/l	ND	ND	ND	ND
1,4-Dichlorobenzene	10/5/2001	ug/l		ND	ND	ND
	3/13/2002	ug/l	ND	ND	ND	ND
2,2-Dichloropropane	10/5/2001	ug/l		ND	ND	ND
	3/13/2002	ug/l	ND	ND	ND	ND
2-Chlorotoluene	10/5/2001	ug/l		ND	ND	ND
	3/13/2002	ug/l	ND	ND	ND	ND
4-Bromofluorobenzene	10/5/2001	ug/l		24.8	24.2	25.4
	3/13/2002	ug/l	24.3	24.8	24.6	25.6
4-Chlorotoluene	10/5/2001	ug/l		ND	ND	ND
	3/13/2002	ug/l	ND	ND	ND	ND



Groundwater Flows (Continued)

Parameters	Sample Date	Units	Well #3	Well #9	Well #23	Well #25
Alkalinity as CaCO3	3/13/2002	mg/l	210	150	180	190
	9/24/2002	mg/l	240	170		210
Azinphos methyl	9/24/2002	ug/l	ND	ND		ND
Azinphosmethyl	3/13/2002	ug/l	ND	ND	ND	ND
Barban	3/13/2002	µg/L	ND	ND	ND	ND
	9/24/2002	µg/L	ND	ND		
Benzene	10/5/2001	ug/l		ND	ND	ND
	3/13/2002	ug/l	ND	ND	ND	ND
Bolstar	3/13/2002	ug/l	ND	ND	ND	ND
	9/24/2002	ug/l	ND	ND		ND
Boron	3/13/2002	mg/l	0.62	0.1	0.18	0.25
	9/24/2002	mg/l	0.64	0.11		0.21
Bromobenzene	10/5/2001	ug/l		ND	ND	ND
	3/13/2002	ug/l	ND	ND	ND	ND
Bromochloromethane	10/5/2001	ug/l		ND	ND	ND
	3/13/2002	ug/l	ND	ND	ND	ND
Bromodichloromethane	10/5/2001	ug/l		ND	ND	ND
	3/13/2002	ug/l	ND	ND	ND	ND
Bromofom	10/5/2001	ug/l		ND	ND	ND
	3/13/2002	ug/l	ND	ND	ND	ND
Bromomethane	10/5/2001	ug/l		ND	ND	ND
	3/13/2002	ug/l	ND	ND	ND	ND
Cadmium	10/3/2001	mg/l		ND	ND	ND
	3/13/2002	mg/l	ND	ND	ND	ND
	9/24/2002	mg/l	ND	ND		ND
Calcium	3/13/2002	mg/l	100	67	100	130
	9/24/2002	mg/l	100	76		140
Carbaryl	3/13/2002	µg/L	ND	ND	ND	ND
	9/24/2002	µg/L	ND	ND		
Carbofuran	3/13/2002	µg/L	ND	ND	ND	ND
	9/24/2002	µg/L	ND	ND		
Carbon tetrachloride	10/5/2001	ug/l		ND	ND	ND
	3/13/2002	ug/l	ND	ND	ND	ND
Chloride	3/13/2002	mg/l	120	51	70	120
	9/24/2002	mg/l	140	60		150
Chlorobenzene	10/5/2001	ug/l		ND	ND	ND
	3/13/2002	ug/l	ND	ND	ND	ND
Chloroethane	10/5/2001	ug/l		ND	ND	ND
	3/13/2002	ug/l	ND	ND	ND	ND
Chloroform	10/5/2001	ug/l		ND	ND	ND
	3/13/2002	ug/l	ND	ND	ND	ND
Chloromethane	10/5/2001	ug/l		ND	ND	ND
	3/13/2002	ug/l	ND	ND	ND	ND
Chloropropham	3/13/2002	µg/L	ND	ND	ND	ND
	9/24/2002	µg/L	ND	ND		
Chlorpyrifos	9/24/2002	ug/l	ND	ND		ND
Chlorpyrifos (Dursban)	3/13/2002	ug/l	ND	ND	ND	ND

Groundwater Flows (Continued)

Parameters	Sample Date	Units	Well #3	Well #9	Well #23	Well #25
Chromium	10/3/2001	mg/l		ND	ND	ND
	3/13/2002	mg/l	ND	ND	ND	ND
	9/24/2002	mg/l	ND	ND		ND
cis-1,2-Dichloroethene	10/5/2001	ug/l		ND	ND	ND
	3/13/2002	ug/l	ND	ND	ND	ND
cis-1,3-Dichloropropene	10/5/2001	ug/l		ND	ND	ND
	3/13/2002	ug/l	ND	ND	ND	ND
Copper	10/3/2001	mg/l		ND	ND	ND
	3/13/2002	mg/l	ND	ND	ND	ND
	9/24/2002	mg/l	ND	ND		ND
Coumaphos	3/13/2002	ug/l	ND	ND	ND	ND
	9/24/2002	ug/l	ND	ND		ND
Def	3/13/2002	ug/l	ND	ND	ND	ND
Demeton	9/24/2002	ug/l	ND	ND		ND
Demeton (Total)	3/13/2002	ug/l	ND	ND	ND	ND
Diazinon	3/13/2002	ug/l	ND	ND	ND	ND
	9/24/2002	ug/l	ND	ND		ND
Dibromochloromethane	10/5/2001	ug/l		ND	ND	ND
	3/13/2002	ug/l	ND	ND	ND	ND
Dibromofluoromethane	10/5/2001	ug/l		26	25.2	26.8
	3/13/2002	ug/l	25.1	26	25.3	26.2
Dibromomethane	10/5/2001	ug/l		ND	ND	ND
	3/13/2002	ug/l	ND	ND	ND	ND
Dichlorodifluoromethane	10/5/2001	ug/l		ND	ND	ND
	3/13/2002	ug/l	ND	ND	ND	ND
Dichlorvos	3/13/2002	ug/l	ND	ND	ND	ND
	9/24/2002	ug/l	ND	ND		ND
Dimethoate	3/13/2002	ug/l	ND	ND	ND	ND
	9/24/2002	ug/l	ND	ND		ND
Disulfoton	3/13/2002	ug/l	ND	ND	ND	ND
	9/24/2002	ug/l	ND	ND		ND
Diuron	3/13/2002	µg/L	ND	ND	ND	ND
	9/24/2002	µg/L	ND	ND		
EPN	3/13/2002	ug/l	ND	ND	ND	ND
	9/24/2002	ug/l	ND	ND		ND
EPTC	3/13/2002	ug/l	ND	ND	ND	ND
Ethion	3/13/2002	ug/l	ND	ND	ND	ND
	9/24/2002	ug/l	ND	ND		ND
Ethoprop	3/13/2002	ug/l	ND	ND	ND	ND
	9/24/2002	ug/l	ND	ND		ND
Ethylbenzene	10/5/2001	ug/l		ND	ND	ND
	3/13/2002	ug/l	ND	ND	ND	ND
Fensulfothion	3/13/2002	ug/l	ND	ND	ND	ND
	9/24/2002	ug/l	ND	ND		ND
Fenthion	3/13/2002	ug/l	ND	ND	ND	ND
	9/24/2002	ug/l	ND	ND		ND
Fenuron	3/13/2002	µg/L	ND	ND	ND	ND
	9/24/2002	µg/L	ND	ND		
Fluometuron	3/13/2002	µg/L	ND	ND	ND	ND
	9/24/2002	µg/L	ND	ND		

Groundwater Flows (Continued)

Parameters	Sample Date	Units	Well #3	Well #9	Well #23	Well #25
Hexachlorobutadiene	10/5/2001	ug/l		ND	ND	ND
	3/13/2002	ug/l	ND	ND	ND	ND
Isopropylbenzene	10/5/2001	ug/l		ND	ND	ND
	3/13/2002	ug/l	ND	ND	ND	ND
Lead	10/3/2001	mg/l		ND	ND	ND
	3/13/2002	mg/l	ND	ND	ND	ND
	9/24/2002	mg/l	ND	ND		ND
Linuron	3/13/2002	µg/L	ND	ND	ND	ND
	9/24/2002	µg/L	ND	ND		
m,p-Xylenes	10/5/2001	ug/l		ND	ND	ND
	3/13/2002	ug/l	ND	ND	ND	ND
Magnesium	3/13/2002	mg/l	24	18	26	30
	9/24/2002	mg/l	24	20		34
Malathion	3/13/2002	ug/l	ND	ND	ND	ND
	9/24/2002	ug/l	ND	ND		ND
Mercury	10/3/2001	mg/l		ND	ND	ND
	3/13/2002	mg/l	ND	ND	ND	ND
	9/24/2002	mg/l	ND	ND		ND
Merphos	3/13/2002	ug/l	ND	ND	ND	ND
	9/24/2002	ug/l	ND	ND		ND
Methomyl	3/13/2002	µg/L	ND	ND	ND	ND
	9/24/2002	µg/L	ND	ND		
Methylene chloride	10/5/2001	ug/l		ND	ND	ND
	3/13/2002	ug/l	ND	ND	ND	ND
Mevinphos	3/13/2002	ug/l	ND	ND	ND	ND
	9/24/2002	ug/l	ND	ND		ND
Monocrotophos	9/24/2002	ug/l	ND	ND		ND
Monuron	3/13/2002	µg/L	ND	ND	ND	ND
	9/24/2002	µg/L	ND	ND		
Naled	3/13/2002	ug/l	ND	ND	ND	ND
	9/24/2002	ug/l	ND	ND		ND
Naphthalene	10/5/2001	ug/l		ND	ND	ND
	3/13/2002	ug/l	ND	ND	ND	ND
n-Butylbenzene	10/5/2001	ug/l		ND	ND	ND
	3/13/2002	ug/l	ND	ND	ND	ND
Neburon	3/13/2002	µg/L	ND	ND	ND	ND
	9/24/2002	µg/L	ND	ND		
Nitrate-NO3	3/13/2002	mg/l	ND	3	1.5	ND
	9/24/2002	mg/l	ND	4.8		ND
n-Propylbenzene	10/5/2001	ug/l		ND	ND	ND
	3/13/2002	ug/l	ND	ND	ND	ND
Orthophosphate	9/24/2002	mg/l	ND	ND		ND
Oxamyl	3/13/2002	µg/L	ND	ND	ND	ND
	9/24/2002	µg/L	ND	ND		
o-Xylene	10/5/2001	ug/l		ND	ND	ND
	3/13/2002	ug/l	ND	ND	ND	ND
Parathion, ethyl	3/13/2002	ug/l	ND	ND	ND	ND
Parathion, methyl	3/13/2002	ug/l	ND	ND	ND	ND
Parathion-ethyl	9/24/2002	ug/l	ND	ND		ND
Parathion-methyl	9/24/2002	ug/l	ND	ND		ND
pH	3/13/2002	pH Units	7.09	7.05	6.81	6.98

Groundwater Flows (Continued)

Parameters	Sample Date	Units	Well #3	Well #9	Well #23	Well #25
Phorate	3/13/2002	ug/l	ND	ND	ND	ND
	9/24/2002	ug/l	ND	ND		ND
p-Isopropyltoluene	10/5/2001	ug/l		ND	ND	ND
	3/13/2002	ug/l	ND	ND	ND	ND
Potassium	3/13/2002	mg/l	3	1.2	3.2	2.3
	9/24/2002	mg/l	3.3	1.6		3
Propham	3/13/2002	µg/L	ND	ND	ND	ND
	9/24/2002	µg/L	ND	ND		
Propoxur	3/13/2002	µg/L	ND	ND	ND	ND
	9/24/2002	µg/L	ND	ND		
Prowl (Pendimethalin)	3/13/2002	ug/l	ND	ND	ND	ND
Ronnel	3/13/2002	ug/l	ND	ND	ND	ND
	9/24/2002	ug/l	ND	ND		ND
sec-Butylbenzene	10/5/2001	ug/l		ND	ND	ND
	3/13/2002	ug/l	ND	ND	ND	ND
Selenium	10/3/2001	mg/l		ND	ND	ND
	3/13/2002	mg/l	ND	ND	ND	ND
	9/24/2002	mg/l	ND	ND		ND
Siduron	3/13/2002	µg/L	ND	ND	ND	ND
	9/24/2002	µg/L	ND	ND		
Sodium	3/13/2002	mg/l	130	42	61	100
	9/24/2002	mg/l	150	52		130
Specific Conductance	3/13/2002	umhos/cm	1300	700	1000	1300
	9/24/2002	umhos/cm	1300	780		1500
Stirophos	3/13/2002	ug/l	ND	ND	ND	ND
	9/24/2002	ug/l	ND	ND		ND
Styrene	10/5/2001	ug/l		ND	ND	ND
	3/13/2002	ug/l	ND	ND	ND	ND
Sulfate	3/13/2002	mg/l	230	110	210	300
	9/24/2002	mg/l	250	120		380
Sulfotep	3/13/2002	ug/l	ND	ND	ND	ND
	9/24/2002	ug/l	ND	ND		ND
Surrogate: Tributylphosphate	3/13/2002	%	99.9	98.8	100	90.7
Surrogate: Triphenylphosphate	3/13/2002	%	85.8	85.1	82.6	77.5
tert-Butylbenzene	10/5/2001	ug/l		ND	ND	ND
	3/13/2002	ug/l	ND	ND	ND	ND
Tetrachloroethene	10/5/2001	ug/l		ND	ND	ND
	3/13/2002	ug/l	ND	ND	ND	ND
Thionazin	9/24/2002	ug/l	ND	ND		ND
Tokuthion	3/13/2002	ug/l	ND	ND	ND	ND
Tokuthion (Prothiofos)	9/24/2002	ug/l	ND	ND		ND
Toluene	10/5/2001	ug/l		ND	ND	ND
	3/13/2002	ug/l	ND	ND	ND	ND
Toluene-d8	10/5/2001	ug/l		27.4	27.4	27.4
	3/13/2002	ug/l	25.9	25.5	24.9	25.8
Total Dissolved Solids	3/13/2002	mg/l	820	440	660	870
	9/24/2002	mg/l	850	500		1000
trans-1,2-Dichloroethene	10/5/2001	ug/l		ND	ND	ND

Groundwater Flows (Continued)

Parameters	Sample Date	Units	Well #3	Well #9	Well #23	Well #25
	3/13/2002	ug/l	ND	ND	ND	ND
trans-1,3-Dichloropropene	10/5/2001	ug/l		ND	ND	ND
	3/13/2002	ug/l	ND	ND	ND	ND
Trichloroethene	10/5/2001	ug/l		ND	ND	ND
	3/13/2002	ug/l	ND	ND	ND	ND
Trichlorofluoromethane	10/5/2001	ug/l		ND	ND	ND
	3/13/2002	ug/l	ND	ND	ND	ND
Trichloronate	3/13/2002	ug/l	ND	ND	ND	ND
	9/24/2002	ug/l	ND	ND		ND
Trifluralin	3/13/2002	ug/l	ND	ND	ND	ND
Triphenyl phosphate	9/24/2002	ug/l	0.709	1.03		0.923
Vinyl chloride	10/5/2001	ug/l		ND	ND	ND
	3/13/2002	ug/l	ND	ND	ND	ND
Zinc	10/3/2001	mg/l		ND	ND	ND
	3/13/2002	mg/l	ND	ND	ND	ND
	9/24/2002	mg/l	ND	ND		ND

**Appendix D:  
Water Balance Results**

# Cañada Chiquita (Alternative B-4) – Total Sub-basin<sup>1</sup>

Pre-dev area = 4200 acres

Post-dev area = 4204 acres

## All Years

	Pre-Development						Post-Development with PDFs							
	INFLOW	OUTFLOW					INFLOW			OUTFLOW				
	Precipitation	Runoff to Chiquita	Runoff to San Juan Crk	GW Outflow	ET	Total	Precipitation	Irrigation	Total	Runoff to Chiquita	Runoff to San Juan Crk	GW Outflow	ET	Total
OCT	0.3 (116)	0.0 (1)	0.0 (0)	0.1 (40)	0.3 (122)	0.5 (163)	0.3 (114)	0.1 (37)	0.4 (151)	0.0 (1)	0.0 (2)	0.1 (47)	0.4 (155)	0.6 (205)
NOV	1.7 (602)	0.0 (7)	0.0 (0)	0.1 (33)	0.7 (235)	0.8 (275)	1.7 (592)	0.0 (16)	1.7 (608)	0.0 (9)	0.0 (10)	0.1 (52)	0.7 (239)	0.9 (310)
DEC	2.3 (794)	0.0 (10)	0.0 (0)	0.1 (41)	0.8 (274)	0.9 (325)	2.2 (781)	0.0 (11)	2.3 (793)	0.0 (13)	0.0 (13)	0.2 (72)	0.8 (266)	1.0 (364)
JAN	3.8 (1336)	0.1 (25)	0.0 (0)	0.4 (131)	0.9 (325)	1.4 (481)	3.8 (1314)	0.0 (10)	3.8 (1324)	0.1 (32)	0.1 (22)	0.5 (180)	0.9 (310)	1.6 (544)
FEB	3.5 (1234)	0.1 (46)	0.0 (1)	0.8 (277)	1.2 (422)	2.1 (747)	3.5 (1214)	0.0 (8)	3.5 (1222)	0.1 (52)	0.1 (20)	0.9 (314)	1.1 (399)	2.2 (784)
MAR	2.9 (1025)	0.0 (14)	0.0 (0)	1.1 (396)	1.8 (625)	3.0 (1035)	2.9 (1008)	0.1 (31)	3.0 (1039)	0.1 (19)	0.0 (17)	1.2 (423)	1.7 (590)	3.0 (1049)
APR	1.2 (417)	0.0 (5)	0.0 (0)	0.7 (242)	2.2 (784)	2.9 (1030)	1.2 (410)	0.2 (59)	1.3 (469)	0.0 (5)	0.0 (6)	0.7 (257)	2.1 (744)	2.9 (1013)
MAY	0.4 (138)	0.0 (1)	0.0 (0)	0.4 (145)	2.2 (771)	2.6 (917)	0.4 (136)	0.2 (75)	0.6 (212)	0.0 (1)	0.0 (2)	0.4 (154)	2.2 (754)	2.6 (912)
JUN	0.1 (49)	0.0 (0)	0.0 (0)	0.3 (96)	1.2 (416)	1.5 (512)	0.1 (48)	0.3 (89)	0.4 (138)	0.0 (0)	0.0 (1)	0.3 (103)	1.3 (464)	1.6 (568)
JUL	0.0 (11)	0.0 (0)	0.0 (0)	0.2 (75)	0.2 (55)	0.4 (130)	0.0 (11)	0.3 (91)	0.3 (102)	0.0 (0)	0.0 (0)	0.2 (82)	0.4 (140)	0.6 (222)
AUG	0.1 (40)	0.0 (0)	0.0 (0)	0.2 (59)	0.1 (40)	0.3 (99)	0.1 (39)	0.2 (84)	0.4 (123)	0.0 (0)	0.0 (1)	0.2 (66)	0.3 (118)	0.5 (186)
SEP	0.4 (123)	0.0 (1)	0.0 (0)	0.1 (46)	0.3 (92)	0.4 (140)	0.3 (121)	0.2 (60)	0.5 (181)	0.0 (2)	0.0 (2)	0.2 (55)	0.4 (147)	0.6 (205)
<b>Total</b>	<b>16.8 (5886)</b>	<b>0.3 (112)</b>	<b>0.0 (1)</b>	<b>4.5 (1581)</b>	<b>11.9 (4160)</b>	<b>16.7 (5854)</b>	<b>16.5 (5790)</b>	<b>1.6 (571)</b>	<b>18.2 (6360)</b>	<b>0.4 (135)</b>	<b>0.3 (95)</b>	<b>5.2 (1806)</b>	<b>12.3 (4326)</b>	<b>18.2 (6362)</b>

## Dry Period

	Pre-Development						Post-Development with PDFs							
	INFLOW	OUTFLOW					INFLOW			OUTFLOW				
	Precipitation	Runoff to Chiquita	Runoff to San Juan Crk	GW Outflow	ET	Total	Precipitation	Irrigation	Total	Runoff to Chiquita	Runoff to San Juan Crk	GW Outflow	ET	Total
OCT	0.3 (116)	0.0 (1)	0.0 (0)	0.1 (30)	0.4 (140)	0.5 (171)	0.3 (114)	0.1 (36)	0.4 (151)	0.0 (1)	0.0 (2)	0.1 (38)	0.5 (170)	0.6 (211)
NOV	1.9 (651)	0.0 (8)	0.0 (0)	0.1 (25)	0.7 (250)	0.8 (283)	1.8 (640)	0.0 (16)	1.9 (656)	0.0 (10)	0.0 (11)	0.1 (47)	0.7 (253)	0.9 (320)
DEC	2.4 (843)	0.0 (11)	0.0 (0)	0.1 (35)	0.8 (288)	1.0 (333)	2.4 (830)	0.0 (11)	2.4 (841)	0.0 (14)	0.0 (14)	0.2 (68)	0.8 (277)	1.1 (373)
JAN	2.8 (997)	0.0 (13)	0.0 (0)	0.2 (56)	0.9 (326)	1.1 (395)	2.8 (981)	0.0 (10)	2.8 (991)	0.0 (17)	0.0 (16)	0.3 (97)	0.9 (311)	1.3 (441)
FEB	2.5 (867)	0.1 (22)	0.0 (0)	0.3 (106)	1.2 (420)	1.6 (548)	2.4 (853)	0.0 (8)	2.5 (861)	0.1 (25)	0.0 (14)	0.4 (140)	1.1 (396)	1.6 (575)
MAR	2.0 (685)	0.0 (8)	0.0 (0)	0.5 (169)	1.8 (617)	2.3 (794)	1.9 (673)	0.1 (31)	2.0 (704)	0.0 (9)	0.0 (11)	0.6 (194)	1.7 (584)	2.3 (798)
APR	1.2 (433)	0.0 (5)	0.0 (0)	0.4 (133)	2.2 (772)	2.6 (909)	1.2 (426)	0.2 (58)	1.4 (484)	0.0 (5)	0.0 (7)	0.4 (150)	2.1 (736)	2.6 (898)
MAY	0.4 (137)	0.0 (1)	0.0 (0)	0.2 (81)	2.1 (732)	2.3 (815)	0.4 (135)	0.2 (74)	0.6 (209)	0.0 (1)	0.0 (2)	0.3 (92)	2.1 (725)	2.3 (820)
JUN	0.1 (35)	0.0 (0)	0.0 (0)	0.2 (57)	1.1 (371)	1.2 (428)	0.1 (35)	0.3 (88)	0.4 (123)	0.0 (0)	0.0 (0)	0.2 (65)	1.2 (428)	1.4 (494)
JUL	0.0 (15)	0.0 (0)	0.0 (0)	0.1 (46)	0.1 (49)	0.3 (95)	0.0 (15)	0.3 (90)	0.3 (104)	0.0 (0)	0.0 (0)	0.2 (54)	0.4 (134)	0.5 (189)
AUG	0.1 (45)	0.0 (0)	0.0 (0)	0.1 (37)	0.1 (42)	0.2 (79)	0.1 (44)	0.2 (83)	0.4 (127)	0.0 (1)	0.0 (1)	0.1 (46)	0.3 (118)	0.5 (165)
SEP	0.3 (117)	0.0 (1)	0.0 (0)	0.1 (30)	0.3 (92)	0.4 (124)	0.3 (115)	0.2 (60)	0.5 (175)	0.0 (1)	0.0 (2)	0.1 (40)	0.4 (145)	0.5 (189)
<b>Total</b>	<b>14.1 (4941)</b>	<b>0.2 (70)</b>	<b>0.0 (0)</b>	<b>2.3 (805)</b>	<b>11.7 (4099)</b>	<b>14.2 (4974)</b>	<b>13.9 (4860)</b>	<b>1.6 (565)</b>	<b>15.5 (5426)</b>	<b>0.2 (84)</b>	<b>0.2 (79)</b>	<b>2.9 (1031)</b>	<b>12.2 (4279)</b>	<b>15.6 (5473)</b>

## Wet Period

	Pre-Development						Post-Development with PDFs							
	INFLOW	OUTFLOW					INFLOW			OUTFLOW				
	Precipitation	Runoff to Chiquita	Runoff to San Juan Crk	GW Outflow	ET	Total	Precipitation	Irrigation	Total	Runoff to Chiquita	Runoff to San Juan Crk	GW Outflow	ET	Total
OCT	0.3 (115)	0.0 (1)	0.0 (0)	0.2 (61)	0.2 (83)	0.4 (145)	0.3 (113)	0.1 (37)	0.4 (150)	0.0 (1)	0.0 (2)	0.2 (67)	0.3 (122)	0.5 (192)
NOV	1.4 (498)	0.0 (6)	0.0 (0)	0.1 (49)	0.6 (202)	0.7 (257)	1.4 (490)	0.0 (16)	1.4 (506)	0.0 (8)	0.0 (8)	0.2 (64)	0.6 (210)	0.8 (289)
DEC	2.0 (691)	0.0 (8)	0.0 (0)	0.2 (53)	0.7 (246)	0.9 (308)	1.9 (679)	0.0 (11)	2.0 (691)	0.0 (11)	0.0 (12)	0.2 (82)	0.7 (241)	1.0 (345)
JAN	5.9 (2054)	0.1 (51)	0.0 (0)	0.8 (290)	0.9 (321)	1.9 (663)	5.8 (2020)	0.0 (10)	5.8 (2030)	0.2 (64)	0.1 (33)	1.0 (355)	0.9 (309)	2.2 (761)
FEB	5.7 (2012)	0.3 (98)	0.0 (3)	1.8 (642)	1.2 (426)	3.3 (1169)	5.6 (1979)	0.0 (8)	5.7 (1987)	0.3 (110)	0.1 (32)	1.9 (682)	1.2 (404)	3.5 (1228)
MAR	5.0 (1745)	0.1 (28)	0.0 (0)	2.5 (878)	1.8 (640)	4.4 (1546)	4.9 (1717)	0.1 (30)	5.0 (1747)	0.1 (41)	0.1 (29)	2.6 (907)	1.7 (605)	4.5 (1582)
APR	1.1 (382)	0.0 (4)	0.0 (0)	1.3 (472)	2.3 (810)	3.7 (1287)	1.1 (376)	0.2 (60)	1.2 (436)	0.0 (5)	0.0 (6)	1.4 (484)	2.2 (761)	3.6 (1256)
MAY	0.4 (141)	0.0 (2)	0.0 (0)	0.8 (280)	2.4 (854)	3.2 (1135)	0.4 (139)	0.2 (76)	0.6 (215)	0.0 (2)	0.0 (2)	0.8 (287)	2.3 (815)	3.2 (1106)
JUN	0.2 (78)	0.0 (1)	0.0 (0)	0.5 (178)	1.5 (510)	2.0 (689)	0.2 (77)	0.3 (89)	0.5 (166)	0.0 (1)	0.0 (1)	0.5 (183)	1.5 (539)	2.1 (724)
JUL	0.0 (4)	0.0 (0)	0.0 (0)	0.4 (135)	0.2 (67)	0.6 (202)	0.0 (4)	0.3 (91)	0.3 (95)	0.0 (0)	0.0 (0)	0.4 (140)	0.4 (151)	0.8 (291)
AUG	0.1 (29)	0.0 (0)	0.0 (0)	0.3 (104)	0.1 (36)	0.4 (140)	0.1 (29)	0.2 (84)	0.3 (113)	0.0 (0)	0.0 (0)	0.3 (109)	0.3 (118)	0.7 (228)
SEP	0.4 (136)	0.0 (2)	0.0 (0)	0.2 (81)	0.3 (94)	0.5 (176)	0.4 (134)	0.2 (60)	0.6 (194)	0.0 (2)	0.0 (2)	0.3 (88)	0.4 (149)	0.7 (240)
<b>Total</b>	<b>22.5 (7887)</b>	<b>0.6 (201)</b>	<b>0.0 (3)</b>	<b>9.2 (3223)</b>	<b>12.3 (4289)</b>	<b>22.0 (7716)</b>	<b>22.1 (7758)</b>	<b>1.6 (572)</b>	<b>23.8 (8330)</b>	<b>0.7 (244)</b>	<b>0.4 (127)</b>	<b>9.8 (3447)</b>	<b>12.6 (4425)</b>	<b>23.5 (8244)</b>

### Notes:

(1) This includes the catchments within the Cañada Chiquita Sub-basin. Due to the grading plans of PA2, the total tributary area increases from pre to post development conditions.

## Cañada Gobernadora (Alternative B-4) – Total Sub-basin

Pre-dev area = 7049 acres

Post-dev area = 7033 acres

### All Years

	Pre-Development						Post-Development with PDEs							
	INFLOW	OUTFLOW					INFLOW			OUTFLOW				
	Precipitation	Runoff to Gobernadora Crk	Runoff to San Juan Crk	Total GW Flows	ET	Total	Precipitation	Irrigation	Total	Runoff to Gobernadora Crk	Runoff to San Juan Crk	Total GW Flows	ET	Total
OCT	0.3 (172)	0.0 (16)	0.0 (0)	0.2 (116)	0.3 (185)	0.5 (317)	0.3 (171)	0.1 (64)	0.4 (235)	0.0 (16)	0.0 (2)	0.2 (125)	0.4 (245)	0.7 (388)
NOV	1.5 (891)	0.2 (131)	0.0 (0)	0.2 (103)	0.5 (267)	0.9 (501)	1.5 (888)	0.0 (27)	1.6 (915)	0.2 (135)	0.0 (13)	0.2 (135)	0.5 (282)	1.0 (565)
DEC	2.0 (1175)	0.3 (193)	0.0 (0)	0.2 (111)	0.5 (289)	1.0 (593)	2.0 (1172)	0.0 (20)	2.0 (1192)	0.3 (196)	0.0 (18)	0.3 (164)	0.5 (284)	1.1 (662)
JAN	3.4 (1974)	0.6 (376)	0.0 (0)	0.3 (169)	0.6 (337)	1.5 (881)	3.4 (1969)	0.0 (16)	3.4 (1985)	0.6 (375)	0.1 (30)	0.4 (246)	0.5 (322)	1.7 (973)
FEB	3.1 (1826)	0.8 (483)	0.0 (2)	0.4 (252)	0.7 (430)	2.0 (1167)	3.1 (1821)	0.0 (12)	3.1 (1834)	0.8 (480)	0.0 (28)	0.5 (310)	0.7 (406)	2.1 (1225)
MAR	2.6 (1517)	0.5 (301)	0.0 (0)	0.6 (354)	1.0 (602)	2.1 (1258)	2.6 (1513)	0.1 (49)	2.7 (1562)	0.5 (296)	0.0 (24)	0.7 (400)	1.0 (571)	2.2 (1292)
APR	1.0 (616)	0.1 (84)	0.0 (0)	0.5 (296)	1.2 (695)	1.8 (1074)	1.0 (614)	0.2 (94)	1.2 (708)	0.1 (83)	0.0 (9)	0.5 (321)	1.1 (656)	1.8 (1069)
MAY	0.4 (206)	0.0 (19)	0.0 (0)	0.4 (237)	1.2 (676)	1.6 (932)	0.3 (205)	0.2 (122)	0.6 (327)	0.0 (19)	0.0 (3)	0.4 (250)	1.2 (678)	1.6 (950)
JUN	0.1 (73)	0.0 (5)	0.0 (0)	0.3 (188)	0.9 (539)	1.2 (732)	0.1 (73)	0.2 (146)	0.4 (218)	0.0 (5)	0.0 (1)	0.3 (194)	1.1 (644)	1.4 (844)
JUL	0.0 (17)	0.0 (1)	0.0 (0)	0.3 (166)	0.7 (384)	0.9 (551)	0.0 (17)	0.3 (150)	0.3 (166)	0.0 (1)	0.0 (0)	0.3 (169)	0.9 (528)	1.2 (698)
AUG	0.1 (60)	0.0 (6)	0.0 (0)	0.2 (145)	0.5 (274)	0.7 (426)	0.1 (59)	0.2 (140)	0.3 (199)	0.0 (7)	0.0 (1)	0.3 (150)	0.7 (407)	1.0 (564)
SEP	0.3 (183)	0.0 (22)	0.0 (0)	0.2 (125)	0.3 (201)	0.6 (348)	0.3 (182)	0.2 (101)	0.5 (283)	0.0 (22)	0.0 (2)	0.2 (133)	0.5 (294)	0.8 (452)
Total	14.8 (8708)	2.8 (1636)	0.0 (2)	3.9 (2262)	8.3 (4879)	14.9 (8780)	14.8 (8685)	1.6 (940)	16.4 (9625)	2.8 (1635)	0.2 (132)	4.4 (2598)	9.1 (5317)	16.5 (9682)

### Dry Period

	Pre-Development						Post-Development with PDEs							
	INFLOW	OUTFLOW					INFLOW			OUTFLOW				
	Precipitation	Runoff to Gobernadora Crk	Runoff to San Juan Crk	Total GW Flows	ET	Total	Precipitation	Irrigation	Total	Runoff to Gobernadora Crk	Runoff to San Juan Crk	Total GW Flows	ET	Total
OCT	0.3 (172)	0.0 (15)	0.0 (0)	0.1 (85)	0.3 (202)	0.5 (302)	0.3 (172)	0.1 (63)	0.4 (235)	0.0 (16)	0.0 (2)	0.2 (95)	0.4 (258)	0.6 (371)
NOV	1.6 (961)	0.2 (143)	0.0 (0)	0.1 (76)	0.5 (284)	0.9 (503)	1.6 (959)	0.0 (27)	1.7 (985)	0.3 (147)	0.0 (14)	0.2 (112)	0.5 (296)	1.0 (570)
DEC	2.1 (1245)	0.4 (206)	0.0 (0)	0.1 (86)	0.5 (299)	1.0 (591)	2.1 (1242)	0.0 (20)	2.2 (1262)	0.4 (209)	0.0 (19)	0.2 (142)	0.5 (291)	1.1 (662)
JAN	2.5 (1469)	0.4 (252)	0.0 (0)	0.2 (104)	0.6 (324)	1.2 (680)	2.5 (1465)	0.0 (16)	2.5 (1481)	0.4 (255)	0.0 (23)	0.3 (172)	0.5 (309)	1.3 (758)
FEB	2.2 (1280)	0.4 (234)	0.0 (0)	0.2 (130)	0.7 (401)	1.3 (764)	2.2 (1277)	0.0 (12)	2.2 (1289)	0.4 (230)	0.0 (19)	0.3 (186)	0.6 (374)	1.4 (810)
MAR	1.7 (1012)	0.3 (148)	0.0 (0)	0.3 (183)	1.0 (587)	1.6 (917)	1.7 (1009)	0.1 (50)	1.8 (1059)	0.2 (142)	0.0 (16)	0.4 (226)	0.9 (554)	1.6 (938)
APR	1.1 (638)	0.2 (88)	0.0 (0)	0.3 (168)	1.2 (714)	1.7 (970)	1.1 (637)	0.2 (94)	1.2 (730)	0.1 (88)	0.0 (9)	0.3 (198)	1.2 (677)	1.7 (972)
MAY	0.3 (204)	0.0 (16)	0.0 (0)	0.2 (137)	1.2 (707)	1.5 (859)	0.3 (203)	0.2 (121)	0.6 (324)	0.0 (16)	0.0 (3)	0.3 (152)	1.2 (711)	1.5 (882)
JUN	0.1 (53)	0.0 (3)	0.0 (0)	0.2 (111)	1.0 (566)	1.2 (680)	0.1 (52)	0.2 (146)	0.3 (198)	0.0 (3)	0.0 (1)	0.2 (119)	1.2 (677)	1.4 (799)
JUL	0.0 (22)	0.0 (1)	0.0 (0)	0.2 (100)	0.7 (435)	0.9 (536)	0.0 (22)	0.3 (150)	0.3 (171)	0.0 (1)	0.0 (0)	0.2 (106)	1.0 (578)	1.2 (685)
AUG	0.1 (67)	0.0 (8)	0.0 (0)	0.2 (89)	0.5 (297)	0.7 (394)	0.1 (67)	0.2 (140)	0.4 (206)	0.0 (8)	0.0 (1)	0.2 (96)	0.7 (429)	0.9 (533)
SEP	0.3 (173)	0.0 (21)	0.0 (0)	0.1 (78)	0.4 (212)	0.5 (310)	0.3 (173)	0.2 (101)	0.5 (274)	0.0 (21)	0.0 (2)	0.1 (88)	0.5 (304)	0.7 (416)
Total	12.4 (7297)	1.9 (1133)	0.0 (0)	2.3 (1346)	8.6 (5027)	12.8 (7507)	12.4 (7277)	1.6 (939)	14.0 (8217)	1.9 (1137)	0.2 (110)	2.9 (1690)	9.3 (5458)	14.3 (8394)

### Wet Period

	Pre-Development						Post-Development with PDEs							
	INFLOW	OUTFLOW					INFLOW			OUTFLOW				
	Precipitation	Runoff to Gobernadora Crk	Runoff to San Juan Crk	Total GW Flows	ET	Total	Precipitation	Irrigation	Total	Runoff to Gobernadora Crk	Runoff to San Juan Crk	Total GW Flows	ET	Total
OCT	0.3 (171)	0.0 (17)	0.0 (0)	0.3 (182)	0.3 (151)	0.6 (350)	0.3 (170)	0.1 (64)	0.4 (234)	0.0 (17)	0.0 (2)	0.3 (189)	0.4 (217)	0.7 (426)
NOV	1.3 (741)	0.2 (106)	0.0 (0)	0.3 (158)	0.4 (232)	0.8 (496)	1.3 (739)	0.0 (27)	1.3 (766)	0.2 (110)	0.0 (11)	0.3 (184)	0.4 (252)	0.9 (556)
DEC	1.7 (1027)	0.3 (166)	0.0 (0)	0.3 (163)	0.5 (268)	1.0 (597)	1.7 (1024)	0.0 (20)	1.8 (1044)	0.3 (167)	0.0 (16)	0.4 (210)	0.5 (268)	1.1 (662)
JAN	5.2 (3045)	1.1 (638)	0.0 (0)	0.5 (307)	0.6 (362)	2.2 (1307)	5.2 (3037)	0.0 (16)	5.2 (3053)	1.1 (628)	0.1 (46)	0.7 (404)	0.6 (350)	2.4 (1428)
FEB	5.1 (2983)	1.7 (1010)	0.0 (6)	0.9 (510)	0.8 (492)	3.4 (2019)	5.1 (2975)	0.0 (12)	5.1 (2987)	1.7 (1008)	0.1 (47)	1.0 (573)	0.8 (474)	3.6 (2104)
MAR	4.4 (2585)	1.1 (627)	0.0 (0)	1.2 (718)	1.1 (635)	3.4 (1980)	4.4 (2579)	0.1 (48)	4.5 (2627)	1.1 (623)	0.1 (42)	1.3 (770)	1.0 (607)	3.5 (2041)
APR	1.0 (568)	0.1 (75)	0.0 (0)	1.0 (566)	1.1 (655)	2.2 (1296)	1.0 (566)	0.2 (95)	1.1 (662)	0.1 (73)	0.0 (8)	1.0 (581)	1.0 (613)	2.2 (1275)
MAY	0.4 (209)	0.0 (25)	0.0 (0)	0.8 (451)	1.0 (611)	1.8 (1087)	0.4 (209)	0.2 (123)	0.6 (332)	0.0 (25)	0.0 (3)	0.8 (457)	1.0 (608)	1.9 (1094)
JUN	0.2 (116)	0.0 (10)	0.0 (0)	0.6 (352)	0.8 (482)	1.4 (843)	0.2 (116)	0.2 (146)	0.4 (262)	0.0 (10)	0.0 (1)	0.6 (353)	1.0 (575)	1.6 (941)
JUL	0.0 (6)	0.0 (0)	0.0 (0)	0.5 (306)	0.5 (275)	1.0 (581)	0.0 (6)	0.3 (150)	0.3 (156)	0.0 (0)	0.0 (0)	0.5 (305)	0.7 (422)	1.2 (727)
AUG	0.1 (44)	0.0 (4)	0.0 (0)	0.4 (264)	0.4 (225)	0.8 (493)	0.1 (44)	0.2 (140)	0.3 (183)	0.0 (4)	0.0 (1)	0.5 (264)	0.6 (359)	1.1 (628)
SEP	0.3 (202)	0.0 (24)	0.0 (0)	0.4 (223)	0.3 (180)	0.7 (427)	0.3 (202)	0.2 (101)	0.5 (302)	0.0 (24)	0.0 (3)	0.4 (229)	0.5 (272)	0.9 (528)
Total	19.9 (11697)	4.6 (2701)	0.0 (7)	7.2 (4201)	7.8 (4567)	19.5 (11475)	19.9 (11666)	1.6 (943)	21.5 (12609)	4.6 (2691)	0.3 (180)	7.7 (4520)	8.6 (5018)	21.2 (12408)

#### Notes:

- (1) This includes the total Cañada Gobernadora Sub-basin. Due to the grading plans of PA3, the total tributary area increases from pre to post development conditions.



## Cañada Gobernadora (Alternative B-4) – Excludes Coto de Caza and Wagon Wheel

Pre-dev area = 2140 acres

Post-dev area = 2124 acres

### All Years

	Pre-Development						Post-Development with PDEs							
	INFLOW	OUTFLOW					INFLOW			OUTFLOW				
	Precipitation	Runoff to Gobernadora Crk	Runoff to San Juan Crk	Total GW Flows	ET	Total	Precipitation	Irrigation	Total	Runoff to Gobernadora Crk	Runoff to San Juan Crk	Total GW Flows	ET	Total
OCT	0.3 (51)	0.0 (1)	0.0 (0)	0.2 (34)	0.3 (46)	0.5 (82)	0.3 (51)	0.4 (64)	0.6 (114)	0.0 (2)	0.0 (2)	0.2 (43)	0.6 (105)	0.9 (153)
NOV	1.5 (266)	0.1 (13)	0.0 (0)	0.2 (30)	0.5 (85)	0.7 (128)	1.5 (264)	0.2 (27)	1.6 (290)	0.1 (16)	0.1 (13)	0.4 (63)	0.6 (100)	1.1 (192)
DEC	2.0 (351)	0.1 (24)	0.0 (0)	0.2 (40)	0.6 (101)	0.9 (165)	2.0 (348)	0.1 (20)	2.1 (367)	0.2 (27)	0.1 (18)	0.5 (93)	0.5 (95)	1.3 (234)
JAN	3.3 (590)	0.3 (61)	0.0 (0)	0.5 (84)	0.7 (119)	1.5 (264)	3.3 (584)	0.1 (16)	3.4 (601)	0.3 (60)	0.2 (30)	0.9 (161)	0.6 (105)	2.0 (356)
FEB	3.1 (545)	0.4 (80)	0.0 (2)	0.8 (140)	0.9 (156)	2.1 (378)	3.1 (540)	0.1 (12)	3.1 (553)	0.4 (77)	0.2 (28)	1.1 (199)	0.7 (132)	2.5 (436)
MAR	2.5 (453)	0.3 (58)	0.0 (0)	1.1 (193)	1.3 (225)	2.7 (476)	2.5 (449)	0.3 (49)	2.8 (498)	0.3 (53)	0.1 (24)	1.4 (239)	1.1 (193)	2.9 (510)
APR	1.0 (184)	0.1 (15)	0.0 (0)	0.8 (135)	1.5 (276)	2.4 (426)	1.0 (182)	0.5 (94)	1.6 (276)	0.1 (14)	0.1 (9)	0.9 (160)	1.3 (237)	2.4 (420)
MAY	0.3 (61)	0.0 (3)	0.0 (0)	0.5 (94)	1.3 (232)	1.8 (329)	0.3 (61)	0.7 (122)	1.0 (182)	0.0 (3)	0.0 (3)	0.6 (106)	1.3 (235)	2.0 (347)
JUN	0.1 (22)	0.0 (1)	0.0 (0)	0.4 (68)	0.5 (91)	0.9 (159)	0.1 (22)	0.8 (146)	0.9 (167)	0.0 (1)	0.0 (1)	0.4 (74)	1.1 (196)	1.5 (271)
JUL	0.0 (5)	0.0 (0)	0.0 (0)	0.3 (56)	0.1 (20)	0.4 (76)	0.0 (5)	0.8 (150)	0.9 (155)	0.0 (0)	0.0 (0)	0.3 (59)	0.9 (164)	1.3 (224)
AUG	0.1 (18)	0.0 (1)	0.0 (0)	0.3 (47)	0.1 (17)	0.4 (65)	0.1 (18)	0.8 (140)	0.9 (157)	0.0 (1)	0.0 (1)	0.3 (51)	0.8 (150)	1.1 (202)
SEP	0.3 (55)	0.0 (2)	0.0 (0)	0.2 (38)	0.2 (35)	0.4 (75)	0.3 (54)	0.6 (101)	0.9 (155)	0.0 (2)	0.0 (2)	0.3 (47)	0.7 (128)	1.0 (179)
<b>Total</b>	<b>14.6 (2600)</b>	<b>1.4 (258)</b>	<b>0.0 (2)</b>	<b>5.4 (959)</b>	<b>7.9 (1403)</b>	<b>14.7 (2622)</b>	<b>14.6 (2577)</b>	<b>5.3 (940)</b>	<b>19.9 (3517)</b>	<b>1.5 (257)</b>	<b>0.7 (132)</b>	<b>7.3 (1296)</b>	<b>10.4 (1840)</b>	<b>19.9 (3524)</b>

### Dry Period

	Pre-Development						Post-Development with PDEs							
	INFLOW	OUTFLOW					INFLOW			OUTFLOW				
	Precipitation	Runoff to Gobernadora Crk	Runoff to San Juan Crk	Total GW Flows	ET	Total	Precipitation	Irrigation	Total	Runoff to Gobernadora Crk	Runoff to San Juan Crk	Total GW Flows	ET	Total
OCT	0.3 (51)	0.0 (1)	0.0 (0)	0.2 (29)	0.3 (52)	0.5 (82)	0.3 (51)	0.4 (63)	0.6 (114)	0.0 (2)	0.0 (2)	0.2 (38)	0.6 (108)	0.9 (151)
NOV	1.6 (287)	0.1 (14)	0.0 (0)	0.1 (26)	0.5 (89)	0.7 (129)	1.6 (284)	0.2 (27)	1.8 (311)	0.1 (17)	0.1 (14)	0.4 (62)	0.6 (102)	1.1 (195)
DEC	2.1 (372)	0.1 (26)	0.0 (0)	0.2 (36)	0.6 (105)	0.9 (166)	2.1 (368)	0.1 (20)	2.2 (388)	0.2 (29)	0.1 (19)	0.5 (92)	0.5 (97)	1.3 (237)
JAN	2.5 (438)	0.2 (33)	0.0 (0)	0.3 (52)	0.7 (118)	1.1 (204)	2.5 (434)	0.1 (16)	2.5 (451)	0.2 (37)	0.1 (23)	0.7 (121)	0.6 (103)	1.6 (283)
FEB	2.1 (382)	0.2 (40)	0.0 (0)	0.4 (78)	0.9 (153)	1.5 (272)	2.1 (379)	0.1 (12)	2.2 (391)	0.2 (37)	0.1 (19)	0.8 (134)	0.7 (127)	1.8 (317)
MAR	1.7 (302)	0.2 (27)	0.0 (0)	0.6 (107)	1.3 (224)	2.0 (359)	1.7 (299)	0.3 (50)	2.0 (349)	0.1 (22)	0.1 (16)	0.8 (150)	1.1 (191)	2.1 (379)
APR	1.1 (191)	0.1 (14)	0.0 (0)	0.5 (88)	1.5 (276)	2.1 (378)	1.1 (189)	0.5 (94)	1.6 (283)	0.1 (14)	0.1 (9)	0.7 (118)	1.3 (239)	2.1 (380)
MAY	0.3 (61)	0.0 (2)	0.0 (0)	0.4 (65)	1.3 (233)	1.7 (300)	0.3 (60)	0.7 (121)	1.0 (181)	0.0 (3)	0.0 (3)	0.5 (80)	1.3 (237)	1.8 (322)
JUN	0.1 (16)	0.0 (0)	0.0 (0)	0.3 (49)	0.5 (84)	0.7 (133)	0.1 (16)	0.8 (146)	0.9 (161)	0.0 (0)	0.0 (1)	0.3 (57)	1.1 (194)	1.4 (252)
JUL	0.0 (7)	0.0 (0)	0.0 (0)	0.2 (42)	0.1 (23)	0.4 (65)	0.0 (6)	0.8 (150)	0.9 (156)	0.0 (0)	0.0 (0)	0.3 (47)	0.9 (166)	1.2 (214)
AUG	0.1 (20)	0.0 (1)	0.0 (0)	0.2 (36)	0.1 (20)	0.3 (56)	0.1 (20)	0.8 (140)	0.9 (159)	0.0 (1)	0.0 (1)	0.2 (42)	0.9 (151)	1.1 (195)
SEP	0.3 (52)	0.0 (2)	0.0 (0)	0.2 (30)	0.2 (36)	0.4 (68)	0.3 (51)	0.6 (101)	0.9 (153)	0.0 (2)	0.0 (2)	0.2 (40)	0.7 (129)	1.0 (174)
<b>Total</b>	<b>12.2 (2178)</b>	<b>0.9 (161)</b>	<b>0.0 (0)</b>	<b>3.6 (638)</b>	<b>7.9 (1412)</b>	<b>12.4 (2212)</b>	<b>12.2 (2158)</b>	<b>5.3 (939)</b>	<b>17.5 (3097)</b>	<b>0.9 (164)</b>	<b>0.6 (110)</b>	<b>5.5 (982)</b>	<b>10.4 (1843)</b>	<b>17.5 (3099)</b>

### Wet Period

	Pre-Development						Post-Development with PDEs							
	INFLOW	OUTFLOW					INFLOW			OUTFLOW				
	Precipitation	Runoff to Gobernadora Crk	Runoff to San Juan Crk	Total GW Flows	ET	Total	Precipitation	Irrigation	Total	Runoff to Gobernadora Crk	Runoff to San Juan Crk	Total GW Flows	ET	Total
OCT	0.3 (51)	0.0 (1)	0.0 (0)	0.3 (45)	0.2 (35)	0.5 (82)	0.3 (51)	0.4 (64)	0.6 (114)	0.0 (2)	0.0 (2)	0.3 (53)	0.6 (101)	0.9 (157)
NOV	1.2 (221)	0.1 (10)	0.0 (0)	0.2 (39)	0.4 (76)	0.7 (124)	1.2 (219)	0.2 (27)	1.4 (246)	0.1 (14)	0.1 (11)	0.4 (64)	0.5 (96)	1.0 (185)
DEC	1.7 (307)	0.1 (22)	0.0 (0)	0.3 (48)	0.5 (92)	0.9 (162)	1.7 (304)	0.1 (20)	1.8 (324)	0.1 (23)	0.1 (16)	0.5 (95)	0.5 (91)	1.3 (226)
JAN	5.1 (910)	0.7 (120)	0.0 (0)	0.8 (149)	0.7 (122)	2.2 (392)	5.1 (902)	0.1 (16)	5.2 (918)	0.6 (110)	0.3 (46)	1.4 (247)	0.6 (110)	2.9 (512)
FEB	5.0 (891)	0.9 (165)	0.0 (6)	1.5 (272)	0.9 (161)	3.4 (604)	5.0 (883)	0.1 (12)	5.1 (896)	0.9 (163)	0.3 (47)	1.9 (335)	0.8 (143)	3.9 (689)
MAR	4.3 (772)	0.7 (124)	0.0 (0)	2.1 (375)	1.3 (226)	4.1 (725)	4.3 (765)	0.3 (48)	4.6 (814)	0.7 (120)	0.2 (42)	2.4 (427)	1.1 (198)	4.4 (787)
APR	1.0 (170)	0.1 (15)	0.0 (0)	1.3 (234)	1.5 (276)	2.9 (526)	0.9 (168)	0.5 (95)	1.5 (263)	0.1 (14)	0.0 (8)	1.4 (249)	1.3 (235)	2.9 (505)
MAY	0.4 (63)	0.0 (5)	0.0 (0)	0.9 (156)	1.3 (232)	2.2 (392)	0.4 (62)	0.7 (123)	1.0 (185)	0.0 (5)	0.0 (3)	0.9 (162)	1.3 (229)	2.3 (399)
JUN	0.2 (35)	0.0 (1)	0.0 (0)	0.6 (108)	0.6 (105)	1.2 (214)	0.2 (34)	0.8 (146)	1.0 (180)	0.0 (1)	0.0 (1)	0.6 (109)	1.1 (199)	1.8 (311)
JUL	0.0 (2)	0.0 (0)	0.0 (0)	0.5 (86)	0.1 (12)	0.6 (99)	0.0 (2)	0.8 (150)	0.9 (152)	0.0 (0)	0.0 (0)	0.5 (85)	0.9 (160)	1.4 (244)
AUG	0.1 (13)	0.0 (0)	0.0 (0)	0.4 (70)	0.1 (13)	0.5 (83)	0.1 (13)	0.8 (140)	0.9 (153)	0.0 (0)	0.0 (1)	0.4 (70)	0.8 (147)	1.2 (218)
SEP	0.3 (60)	0.0 (2)	0.0 (0)	0.3 (56)	0.2 (32)	0.5 (90)	0.3 (60)	0.6 (101)	0.9 (161)	0.0 (2)	0.0 (3)	0.4 (62)	0.7 (125)	1.1 (191)
<b>Total</b>	<b>19.6 (3494)</b>	<b>2.6 (464)</b>	<b>0.0 (7)</b>	<b>9.2 (1639)</b>	<b>7.8 (1382)</b>	<b>19.6 (3492)</b>	<b>19.6 (3464)</b>	<b>5.3 (943)</b>	<b>24.9 (4406)</b>	<b>2.6 (454)</b>	<b>1.0 (180)</b>	<b>11.1 (1959)</b>	<b>10.4 (1833)</b>	<b>25.0 (4425)</b>

#### Notes:

- (1) This includes the catchments within the Cañada Gobernadora Sub-basin with the exception of Coto de Caza and Wagon Wheel. Due to the grading plans of PA3, the total tributary area increases from pre to post development conditions.

# Cañada Gobernadora (Alternative B-4) – Coto de Caza & Wagon Wheel (Multi-Purpose Basin)<sup>1</sup>

Pre-dev area = 4909 acres

Post-dev area = 4909 acres

## All Years

	Current Conditions without the Multi-Purpose Basin					Current Conditions with the Multi-Purpose Basin					
	INFLOW	OUTFLOW				INFLOW	OUTFLOW				
	Precipitation	Runoff to Gobernadora Crk	Total GO Flows	ET	Total	Precipitation	Withdrawal from Modulation Basin	Discharge to Gobernadora (bypass)	GW Flows	ET	Total
OCT	0.3 (120)	0.0 (14)	0.2 (82)	0.3 (139)	0.6 (236)	0.3 (120)	0.0 (13)	0.0 (0)	0.2 (82)	0.3 (139)	0.6 (234)
NOV	1.5 (625)	0.3 (119)	0.2 (72)	0.4 (182)	0.9 (373)	1.5 (625)	0.3 (110)	0.0 (0)	0.2 (72)	0.4 (183)	0.9 (365)
DEC	2.0 (824)	0.4 (169)	0.2 (71)	0.5 (189)	1.0 (428)	2.0 (824)	0.4 (164)	0.0 (2)	0.2 (71)	0.5 (189)	1.0 (426)
JAN	3.4 (1385)	0.8 (314)	0.2 (85)	0.5 (217)	1.5 (617)	3.4 (1385)	0.7 (290)	0.0 (14)	0.2 (85)	0.5 (218)	1.5 (607)
FEB	3.1 (1281)	1.0 (402)	0.3 (112)	0.7 (274)	1.9 (788)	3.1 (1281)	0.7 (294)	0.3 (126)	0.3 (112)	0.7 (275)	2.0 (807)
MAR	2.6 (1064)	0.6 (243)	0.4 (161)	0.9 (377)	1.9 (782)	2.6 (1064)	0.6 (251)	0.0 (19)	0.4 (161)	0.9 (379)	2.0 (811)
APR	1.1 (432)	0.2 (69)	0.4 (160)	1.0 (419)	1.6 (649)	1.1 (432)	0.2 (67)	0.0 (0)	0.4 (160)	1.0 (420)	1.6 (648)
MAY	0.4 (144)	0.0 (16)	0.4 (143)	1.1 (443)	1.5 (603)	0.4 (144)	0.0 (17)	0.0 (0)	0.4 (143)	1.1 (444)	1.5 (604)
JUN	0.1 (51)	0.0 (4)	0.3 (120)	1.1 (448)	1.4 (573)	0.1 (51)	0.0 (3)	0.0 (0)	0.3 (120)	1.1 (449)	1.4 (572)
JUL	0.0 (12)	0.0 (1)	0.3 (110)	0.9 (364)	1.2 (475)	0.0 (12)	0.0 (0)	0.0 (0)	0.3 (110)	0.9 (364)	1.2 (474)
AUG	0.1 (42)	0.0 (6)	0.2 (98)	0.6 (257)	0.9 (361)	0.1 (42)	0.0 (5)	0.0 (0)	0.2 (98)	0.6 (257)	0.9 (361)
SEP	0.3 (128)	0.0 (20)	0.2 (86)	0.4 (166)	0.7 (272)	0.3 (128)	0.0 (18)	0.0 (0)	0.2 (86)	0.4 (167)	0.7 (271)
Total	14.9 (6108)	3.4 (1378)	3.2 (1302)	8.5 (3477)	15.1 (6157)	14.9 (6108)	3.0 (1232)	0.4 (161)	3.2 (1302)	8.5 (3485)	15.1 (6180)

## Dry Period

	Current Conditions without the Multi-Purpose Basin					Current Conditions with the Multi-Purpose Basin					
	INFLOW	OUTFLOW				INFLOW	OUTFLOW				
	Precipitation	Runoff to Gobernadora Crk	Total GW Flows	ET	Total	Precipitation	Withdrawal from Modulation Basin	Discharge to Gobernadora (bypass)	GW Flows	ET	Total
OCT	0.3 (121)	0.0 (14)	0.1 (56)	0.4 (150)	0.5 (220)	0.3 (121)	0.0 (12)	0.0 (0)	0.1 (56)	0.4 (150)	0.5 (219)
NOV	1.6 (674)	0.3 (129)	0.1 (50)	0.5 (195)	0.9 (374)	1.6 (674)	0.3 (122)	0.0 (0)	0.1 (50)	0.5 (196)	0.9 (368)
DEC	2.1 (874)	0.4 (181)	0.1 (50)	0.5 (194)	1.0 (425)	2.1 (874)	0.4 (172)	0.0 (3)	0.1 (50)	0.5 (195)	1.0 (419)
JAN	2.5 (1030)	0.5 (218)	0.1 (51)	0.5 (206)	1.2 (476)	2.5 (1030)	0.5 (207)	0.0 (8)	0.1 (51)	0.5 (207)	1.2 (474)
FEB	2.2 (898)	0.5 (193)	0.1 (52)	0.6 (247)	1.2 (493)	2.2 (898)	0.4 (165)	0.0 (17)	0.1 (52)	0.6 (248)	1.2 (483)
MAR	1.7 (710)	0.3 (120)	0.2 (76)	0.9 (363)	1.4 (558)	1.7 (710)	0.3 (117)	0.0 (0)	0.2 (76)	0.9 (364)	1.4 (557)
APR	1.1 (448)	0.2 (74)	0.2 (80)	1.1 (438)	1.4 (592)	1.1 (448)	0.2 (69)	0.0 (0)	0.2 (80)	1.1 (439)	1.4 (587)
MAY	0.3 (143)	0.0 (14)	0.2 (72)	1.2 (474)	1.4 (559)	0.3 (143)	0.0 (12)	0.0 (0)	0.2 (72)	1.2 (474)	1.4 (558)
JUN	0.1 (37)	0.0 (2)	0.2 (62)	1.2 (483)	1.3 (547)	0.1 (37)	0.0 (1)	0.0 (0)	0.2 (62)	1.2 (483)	1.3 (546)
JUL	0.0 (15)	0.0 (1)	0.1 (58)	1.0 (412)	1.2 (471)	0.0 (15)	0.0 (1)	0.0 (0)	0.1 (58)	1.0 (412)	1.2 (471)
AUG	0.1 (47)	0.0 (7)	0.1 (53)	0.7 (278)	0.8 (338)	0.1 (47)	0.0 (6)	0.0 (0)	0.1 (53)	0.7 (278)	0.8 (338)
SEP	0.3 (122)	0.0 (19)	0.1 (48)	0.4 (175)	0.6 (242)	0.3 (122)	0.0 (17)	0.0 (0)	0.1 (48)	0.4 (176)	0.6 (241)
Total	12.5 (5119)	2.4 (972)	1.7 (708)	8.8 (3615)	12.9 (5295)	12.5 (5119)	2.2 (901)	0.1 (28)	1.7 (708)	8.9 (3622)	12.9 (5259)

## Wet Period

	Current Conditions without the Multi-Purpose Basin					Current Conditions with the Multi-Purpose Basin					
	INFLOW	OUTFLOW				INFLOW	OUTFLOW				
	Precipitation	Runoff to Gobernadora Crk	Total GW Flows	ET	Total	Precipitation	Withdrawal from Modulation Basin	Discharge to Gobernadora (bypass)	GW Flows	ET	Total
OCT	0.3 (120)	0.0 (15)	0.3 (137)	0.3 (116)	0.7 (268)	0.3 (120)	0.0 (13)	0.0 (0)	0.3 (137)	0.3 (116)	0.7 (266)
NOV	1.3 (520)	0.2 (96)	0.3 (120)	0.4 (156)	0.9 (372)	1.3 (520)	0.2 (84)	0.0 (0)	0.3 (120)	0.4 (156)	0.9 (359)
DEC	1.8 (720)	0.4 (144)	0.3 (115)	0.4 (176)	1.1 (436)	1.8 (720)	0.4 (147)	0.0 (0)	0.3 (115)	0.4 (176)	1.1 (439)
JAN	5.2 (2135)	1.3 (518)	0.4 (157)	0.6 (240)	2.2 (915)	5.2 (2135)	1.1 (465)	0.1 (26)	0.4 (157)	0.6 (240)	2.2 (889)
FEB	5.1 (2092)	2.1 (846)	0.6 (238)	0.8 (331)	3.5 (1415)	5.1 (2092)	1.4 (567)	0.9 (357)	0.6 (238)	0.8 (331)	3.6 (1493)
MAR	4.4 (1813)	1.2 (503)	0.8 (343)	1.0 (409)	3.1 (1255)	4.4 (1813)	1.3 (535)	0.1 (59)	0.8 (343)	1.0 (409)	3.3 (1346)
APR	1.0 (398)	0.1 (60)	0.8 (332)	0.9 (378)	1.9 (770)	1.0 (398)	0.2 (65)	0.0 (0)	0.8 (332)	0.9 (378)	1.9 (775)
MAY	0.4 (147)	0.0 (20)	0.7 (295)	0.9 (379)	1.7 (695)	0.4 (147)	0.1 (27)	0.0 (0)	0.7 (295)	0.9 (379)	1.7 (701)
JUN	0.2 (82)	0.0 (9)	0.6 (244)	0.9 (376)	1.5 (629)	0.2 (82)	0.0 (8)	0.0 (0)	0.6 (244)	0.9 (376)	1.5 (628)
JUL	0.0 (4)	0.0 (0)	0.5 (220)	0.6 (263)	1.2 (482)	0.0 (4)	0.0 (0)	0.0 (0)	0.5 (220)	0.6 (263)	1.2 (482)
AUG	0.1 (31)	0.0 (4)	0.5 (194)	0.5 (212)	1.0 (410)	0.1 (31)	0.0 (3)	0.0 (0)	0.5 (194)	0.5 (212)	1.0 (409)
SEP	0.3 (142)	0.1 (22)	0.4 (167)	0.4 (148)	0.8 (336)	0.3 (142)	0.0 (19)	0.0 (0)	0.4 (167)	0.4 (148)	0.8 (334)
Total	20.1 (8203)	5.5 (2237)	6.3 (2561)	7.8 (3185)	19.5 (7983)	20.1 (8203)	4.7 (1933)	1.1 (443)	6.3 (2561)	7.8 (3185)	19.9 (8122)

### Notes:

- (1) This only includes Coto de Caza and Wagon Wheel, which are existing developments within the Cañada Gobernadora Sub-basin. The purpose of these tables is to show the predicted effects of the proposed multi-purpose basin located at the down gradient end of the existing development.

# Central San Juan (Alternative B-4) - Total Sub-basin<sup>1</sup>

Pre-dev area = 4810 acres

Post-dev area = 4916 acres

## All Years

	Pre-Development								Post-Development with PDFs							
	INFLOW			OUTFLOW					INFLOW			OUTFLOW				
	Precipitation	Irrigation	Total	Quarry Runoff Recirculation	Runoff to SJ Crk	GW Outflow	ET	Total	Precipitation	Irrigation	Total	Runoff to SJ Crk	GW Outflow	ET	Total	
OCT	0.3 (124)	0.0 (19)	0.4 (143)	0.0 (1)	0.0 (3)	0.2 (83)	0.3 (130)	0.5 (217)	0.3 (128)	0.4 (158)	0.7 (286)	0.0 (4)	0.3 (130)	0.6 (240)	0.9 (373)	
NOV	1.6 (643)	0.0 (9)	1.6 (652)	0.2 (8)	0.1 (29)	0.2 (80)	0.5 (191)	0.8 (307)	1.6 (663)	0.2 (67)	1.8 (730)	0.1 (40)	0.6 (226)	0.5 (221)	1.2 (487)	
DEC	2.1 (850)	0.0 (6)	2.1 (856)	0.3 (10)	0.2 (59)	0.4 (146)	0.5 (216)	1.1 (431)	2.1 (876)	0.1 (49)	2.3 (925)	0.2 (69)	0.9 (353)	0.5 (208)	1.5 (630)	
JAN	3.6 (1429)	0.0 (5)	3.6 (1435)	0.5 (18)	0.4 (149)	0.8 (317)	0.6 (245)	1.8 (730)	3.6 (1472)	0.1 (41)	3.7 (1513)	0.4 (160)	1.5 (599)	0.6 (226)	2.4 (985)	
FEB	3.3 (1321)	0.0 (4)	3.3 (1325)	0.6 (21)	0.5 (190)	1.2 (469)	0.8 (315)	2.5 (995)	3.3 (1360)	0.1 (31)	3.4 (1391)	0.5 (186)	1.7 (694)	0.7 (277)	2.8 (1157)	
MAR	2.7 (1097)	0.0 (17)	2.8 (1114)	0.4 (13)	0.4 (131)	1.5 (610)	1.1 (445)	3.0 (1199)	2.8 (1130)	0.3 (123)	3.1 (1253)	0.3 (124)	2.0 (801)	1.0 (409)	3.3 (1334)	
APR	1.1 (446)	0.1 (33)	1.2 (479)	0.1 (5)	0.1 (34)	1.0 (418)	1.3 (515)	2.4 (972)	1.1 (459)	0.6 (234)	1.7 (693)	0.1 (28)	1.2 (508)	1.2 (485)	2.5 (1021)	
MAY	0.4 (149)	0.1 (42)	0.5 (191)	0.0 (2)	0.0 (7)	0.7 (273)	1.1 (458)	1.8 (740)	0.4 (153)	0.7 (303)	1.1 (456)	0.0 (7)	0.8 (318)	1.2 (481)	2.0 (806)	
JUN	0.1 (53)	0.1 (49)	0.3 (102)	0.0 (1)	0.0 (1)	0.5 (185)	0.6 (258)	1.1 (444)	0.1 (54)	0.9 (362)	1.0 (417)	0.0 (1)	0.5 (214)	1.0 (411)	1.5 (626)	
JUL	0.0 (12)	0.1 (50)	0.2 (62)	0.0 (0)	0.0 (0)	0.4 (146)	0.3 (110)	0.6 (257)	0.0 (13)	0.9 (372)	0.9 (385)	0.0 (0)	0.4 (171)	0.9 (359)	1.3 (530)	
AUG	0.1 (43)	0.1 (45)	0.2 (88)	0.0 (0)	0.0 (1)	0.3 (118)	0.2 (89)	0.5 (209)	0.1 (44)	0.8 (347)	1.0 (391)	0.0 (2)	0.4 (149)	0.8 (336)	1.2 (487)	
SEP	0.3 (132)	0.1 (32)	0.4 (165)	0.0 (2)	0.0 (4)	0.2 (95)	0.3 (111)	0.5 (212)	0.3 (136)	0.6 (252)	0.9 (388)	0.0 (6)	0.3 (142)	0.7 (288)	1.1 (435)	
Total	15.7 (6299)	0.8 (312)	16.5 (6612)	2.3 (81)	1.7 (608)	7.3 (2941)	7.7 (3082)	16.7 (6713)	15.8 (6489)	5.7 (2338)	21.5 (8827)	1.5 (628)	10.5 (4304)	9.6 (3940)	21.7 (8872)	

## Dry Period

	Pre-Development								Post-Development with PDFs							
	INFLOW			OUTFLOW					INFLOW			OUTFLOW				
	Precipitation	Irrigation	Total	Quarry Runoff Recirculation	Runoff to SJ Crk	GW Outflow	ET	Total	Precipitation	Irrigation	Total	Runoff to SJ Crk	GW Outflow	ET	Total	
OCT	0.3 (124)	0.0 (19)	0.4 (144)	0.0 (1)	0.0 (3)	0.2 (72)	0.3 (140)	0.5 (217)	0.3 (128)	0.4 (158)	0.7 (286)	0.0 (4)	0.3 (121)	0.6 (245)	0.9 (370)	
NOV	1.7 (694)	0.0 (8)	1.8 (702)	0.2 (8)	0.1 (31)	0.2 (73)	0.5 (201)	0.8 (314)	1.7 (715)	0.2 (66)	1.9 (782)	0.1 (44)	0.6 (232)	0.6 (226)	1.2 (501)	
DEC	2.2 (901)	0.0 (6)	2.3 (907)	0.3 (11)	0.2 (63)	0.3 (139)	0.6 (224)	1.1 (437)	2.3 (928)	0.1 (49)	2.4 (977)	0.2 (75)	0.9 (358)	0.5 (212)	1.6 (645)	
JAN	2.7 (1063)	0.0 (5)	2.7 (1069)	0.4 (13)	0.2 (87)	0.6 (226)	0.6 (243)	1.4 (569)	2.7 (1096)	0.1 (41)	2.8 (1136)	0.2 (100)	1.1 (471)	0.5 (222)	1.9 (793)	
FEB	2.3 (925)	0.0 (4)	2.3 (930)	0.4 (13)	0.2 (98)	0.8 (310)	0.8 (309)	1.8 (730)	2.3 (954)	0.1 (31)	2.4 (985)	0.2 (94)	1.2 (501)	0.7 (270)	2.1 (865)	
MAR	1.8 (732)	0.0 (18)	1.9 (749)	0.2 (9)	0.2 (63)	0.9 (373)	1.1 (441)	2.2 (886)	1.8 (754)	0.3 (124)	2.1 (878)	0.1 (52)	1.3 (533)	1.0 (404)	2.4 (990)	
APR	1.2 (462)	0.1 (33)	1.2 (495)	0.2 (5)	0.1 (33)	0.7 (290)	1.3 (518)	2.1 (847)	1.2 (476)	0.6 (233)	1.7 (709)	0.1 (29)	1.0 (397)	1.2 (486)	2.2 (911)	
MAY	0.4 (147)	0.1 (42)	0.5 (189)	0.0 (2)	0.0 (5)	0.5 (199)	1.2 (475)	1.7 (681)	0.4 (152)	0.7 (301)	1.1 (453)	0.0 (5)	0.6 (252)	1.2 (490)	1.8 (747)	
JUN	0.1 (38)	0.1 (49)	0.2 (87)	0.0 (0)	0.0 (1)	0.4 (140)	0.7 (263)	1.0 (405)	0.1 (39)	0.9 (362)	1.0 (401)	0.0 (1)	0.4 (173)	1.0 (412)	1.4 (586)	
JUL	0.0 (16)	0.1 (50)	0.2 (65)	0.0 (0)	0.0 (0)	0.3 (114)	0.3 (117)	0.6 (231)	0.0 (16)	0.9 (372)	0.9 (388)	0.0 (0)	0.3 (143)	0.9 (362)	1.2 (506)	
AUG	0.1 (48)	0.1 (45)	0.2 (94)	0.0 (1)	0.0 (2)	0.2 (94)	0.2 (91)	0.5 (187)	0.1 (50)	0.8 (347)	1.0 (397)	0.0 (2)	0.3 (130)	0.8 (337)	1.1 (470)	
SEP	0.3 (126)	0.1 (32)	0.4 (158)	0.0 (1)	0.0 (4)	0.2 (78)	0.3 (113)	0.5 (196)	0.3 (129)	0.6 (252)	0.9 (382)	0.0 (6)	0.3 (127)	0.7 (289)	1.0 (422)	
Total	13.2 (5277)	0.8 (312)	13.9 (5589)	1.8 (64)	1.1 (391)	5.3 (2109)	7.8 (3136)	14.2 (5700)	13.3 (5437)	5.7 (2336)	19.0 (7773)	1.0 (412)	8.4 (3437)	9.7 (3956)	19.0 (7804)	

## Wet Period

	Pre-Development								Post-Development with PDFs							
	INFLOW			OUTFLOW					INFLOW			OUTFLOW				
	Precipitation	Irrigation	Total	Quarry Runoff Recirculation	Runoff to SJ Crk	GW Outflow	ET	Total	Precipitation	Irrigation	Total	Runoff to SJ Crk	GW Outflow	ET	Total	
OCT	0.3 (124)	0.0 (19)	0.4 (143)	0.0 (1)	0.0 (3)	0.3 (107)	0.3 (108)	0.5 (219)	0.3 (127)	0.4 (159)	0.7 (286)	0.0 (4)	0.4 (148)	0.6 (229)	0.9 (381)	
NOV	1.3 (536)	0.0 (9)	1.4 (545)	0.2 (6)	0.1 (24)	0.2 (95)	0.4 (169)	0.7 (293)	1.3 (552)	0.2 (68)	1.5 (620)	0.1 (33)	0.5 (215)	0.5 (211)	1.1 (458)	
DEC	1.9 (742)	0.0 (6)	1.9 (748)	0.3 (9)	0.1 (51)	0.4 (161)	0.5 (199)	1.0 (419)	1.9 (764)	0.1 (50)	2.0 (814)	0.1 (58)	0.8 (342)	0.5 (199)	1.5 (599)	
JAN	5.5 (2204)	0.0 (5)	5.5 (2210)	0.9 (30)	0.8 (279)	1.3 (510)	0.6 (250)	2.7 (1070)	5.5 (2270)	0.1 (41)	5.6 (2310)	0.7 (286)	2.1 (871)	0.6 (234)	3.4 (1391)	
FEB	5.4 (2157)	0.0 (4)	5.4 (2162)	1.1 (38)	1.1 (385)	2.0 (807)	0.8 (327)	3.9 (1557)	5.4 (2222)	0.1 (31)	5.5 (2252)	0.9 (382)	2.7 (1103)	0.7 (289)	4.3 (1774)	
MAR	4.7 (1870)	0.0 (17)	4.7 (1887)	0.6 (22)	0.8 (275)	2.8 (1110)	1.1 (453)	4.6 (1861)	4.7 (1926)	0.3 (121)	5.0 (2046)	0.7 (277)	3.3 (1368)	1.0 (420)	5.0 (2065)	
APR	1.0 (411)	0.1 (33)	1.1 (445)	0.1 (5)	0.1 (34)	1.7 (687)	1.3 (510)	3.1 (1235)	1.0 (423)	0.6 (237)	1.6 (660)	0.1 (28)	1.8 (743)	1.2 (483)	3.1 (1254)	
MAY	0.4 (152)	0.1 (42)	0.5 (194)	0.0 (2)	0.0 (11)	1.1 (431)	1.1 (423)	2.2 (867)	0.4 (156)	0.7 (305)	1.1 (461)	0.0 (11)	1.1 (458)	1.1 (462)	2.3 (931)	
JUN	0.2 (84)	0.1 (49)	0.3 (134)	0.0 (1)	0.0 (2)	0.7 (279)	0.6 (246)	1.3 (527)	0.2 (87)	0.9 (363)	1.1 (450)	0.0 (3)	0.7 (300)	1.0 (409)	1.7 (712)	
JUL	0.0 (5)	0.1 (50)	0.1 (54)	0.0 (0)	0.0 (0)	0.5 (214)	0.2 (97)	0.8 (311)	0.0 (5)	0.9 (373)	0.9 (377)	0.0 (0)	0.6 (229)	0.9 (353)	1.4 (582)	
AUG	0.1 (32)	0.1 (45)	0.2 (77)	0.0 (0)	0.0 (1)	0.4 (168)	0.2 (84)	0.6 (253)	0.1 (33)	0.8 (347)	0.9 (380)	0.0 (1)	0.5 (190)	0.8 (333)	1.3 (524)	
SEP	0.4 (147)	0.1 (32)	0.4 (179)	0.0 (2)	0.0 (4)	0.3 (133)	0.3 (107)	0.6 (245)	0.4 (151)	0.6 (251)	1.0 (402)	0.0 (6)	0.4 (173)	0.7 (285)	1.1 (464)	
Total	21.1 (8465)	0.8 (313)	21.9 (8778)	3.3 (116)	2.9 (1068)	11.7 (4703)	7.4 (2969)	22.1 (8858)	21.3 (8716)	5.7 (2344)	27.0 (11059)	2.7 (1086)	15.0 (6140)	9.5 (3908)	27.2 (11134)	

### Notes:

(1) This includes the catchments within the Central San Juan Sub-basin. Due to the grading plans of PA3, PA4, and PA5, the total tributary area increases from pre to post development conditions.

# Central San Juan (Alternative B-4) – Trampas Creek<sup>1</sup>

Pre-dev area = 650 acres (excludes quarry)

Post-dev area = 1013 acres

## All Years

	Pre-Development <sup>2</sup>								Post-Development with PDFs <sup>3</sup>							
	INFLOW			OUTFLOW					INFLOW			OUTFLOW				
	Precipitation	Irrigation	Total	Quarry Runoff Recirculation	Runoff to SJ Crk	GW Outflow	ET	Total	Precipitation	Irrigation	Total	Runoff to SJ Crk	GW Outflow	ET	Total	
OCT	0.3 (17)	0.0 (0)	0.3 (17)	0.0 (0)	0.0 (0)	0.2 (9)	0.3 (18)	0.5 (27)	0.3 (27)	0.5 (44)	0.8 (71)	0.0 (0)	0.3 (29)	0.7 (60)	1.1 (90)	
NOV	1.7 (90)	0.0 (0)	1.7 (90)	0.0 (0)	0.0 (0)	0.1 (8)	0.6 (31)	0.7 (39)	1.7 (140)	0.2 (19)	1.9 (158)	0.0 (1)	0.7 (62)	0.6 (50)	1.3 (113)	
DEC	2.2 (119)	0.0 (0)	2.2 (119)	0.0 (0)	0.0 (0)	0.3 (15)	0.7 (36)	0.9 (51)	2.2 (184)	0.2 (14)	2.3 (198)	0.0 (1)	1.2 (97)	0.5 (43)	1.7 (142)	
JAN	3.7 (200)	0.0 (0)	3.7 (200)	0.0 (0)	0.0 (2)	0.7 (39)	0.8 (41)	1.5 (83)	3.7 (310)	0.1 (11)	3.8 (321)	0.0 (3)	2.0 (166)	0.5 (46)	2.5 (215)	
FEB	3.4 (185)	0.0 (0)	3.4 (185)	0.0 (0)	0.2 (8)	1.2 (66)	1.0 (52)	2.3 (127)	3.4 (286)	0.1 (9)	3.5 (295)	0.1 (6)	2.2 (184)	0.7 (55)	2.9 (245)	
MAR	2.8 (154)	0.0 (0)	2.8 (154)	0.0 (0)	0.0 (1)	1.7 (89)	1.5 (80)	3.1 (170)	2.8 (238)	0.4 (34)	3.2 (272)	0.0 (2)	2.4 (204)	1.0 (83)	3.4 (290)	
APR	1.2 (63)	0.0 (0)	1.2 (63)	0.0 (0)	0.0 (0)	1.1 (59)	1.9 (102)	3.0 (161)	1.1 (97)	0.8 (65)	1.9 (162)	0.0 (0)	1.4 (120)	1.3 (106)	2.7 (227)	
MAY	0.4 (21)	0.0 (0)	0.4 (21)	0.0 (0)	0.0 (0)	0.7 (37)	1.5 (80)	2.2 (117)	0.4 (32)	1.0 (84)	1.4 (116)	0.0 (0)	0.9 (73)	1.3 (109)	2.2 (182)	
JUN	0.1 (7)	0.0 (0)	0.1 (7)	0.0 (0)	0.0 (0)	0.4 (24)	0.4 (22)	0.9 (46)	0.1 (11)	1.2 (100)	1.3 (112)	0.0 (0)	0.6 (47)	1.2 (100)	1.7 (147)	
JUL	0.0 (2)	0.0 (0)	0.0 (2)	0.0 (0)	0.0 (0)	0.3 (18)	0.0 (2)	0.4 (20)	0.0 (3)	1.2 (103)	1.3 (106)	0.0 (0)	0.4 (37)	1.1 (94)	1.6 (131)	
AUG	0.1 (6)	0.0 (0)	0.1 (6)	0.0 (0)	0.0 (0)	0.3 (14)	0.1 (5)	0.4 (19)	0.1 (9)	1.1 (96)	1.3 (106)	0.0 (0)	0.4 (32)	1.1 (90)	1.5 (123)	
SEP	0.3 (19)	0.0 (0)	0.3 (19)	0.0 (0)	0.0 (0)	0.2 (11)	0.2 (13)	0.4 (24)	0.3 (29)	0.8 (70)	1.2 (99)	0.0 (0)	0.4 (32)	0.9 (76)	1.3 (108)	
Total	16.3 (883)	0.0 (0)	16.3 (883)	0.0 (0)	0.2 (12)	7.2 (391)	8.9 (480)	16.3 (883)	16.2 (1366)	7.7 (649)	23.9 (2015)	0.2 (14)	12.8 (1085)	10.8 (912)	23.8 (2010)	

## Dry Period

	Pre-Development <sup>2</sup>								Post-Development with PDFs <sup>3</sup>							
	INFLOW			OUTFLOW					INFLOW			OUTFLOW				
	Precipitation	Irrigation	Total	Quarry Runoff Recirculation	Runoff to SJ Crk	GW Outflow	ET	Total	Precipitation	Irrigation	Total	Runoff to SJ Crk	GW Outflow	ET	Total	
OCT	0.3 (17)	0.0 (0)	0.3 (17)	0.0 (0)	0.0 (0)	0.1 (8)	0.4 (20)	0.5 (28)	0.3 (27)	0.5 (44)	0.8 (71)	0.0 (0)	0.3 (28)	0.7 (61)	1.1 (89)	
NOV	1.8 (97)	0.0 (0)	1.8 (97)	0.0 (0)	0.0 (0)	0.1 (7)	0.6 (32)	0.7 (39)	1.8 (150)	0.2 (18)	2.0 (169)	0.0 (0)	0.8 (66)	0.6 (50)	1.4 (116)	
DEC	2.3 (126)	0.0 (0)	2.3 (126)	0.0 (0)	0.0 (0)	0.3 (14)	0.7 (37)	0.9 (51)	2.3 (195)	0.2 (14)	2.5 (209)	0.0 (1)	1.2 (100)	0.5 (43)	1.7 (145)	
JAN	2.8 (149)	0.0 (0)	2.8 (149)	0.0 (0)	0.0 (0)	0.5 (24)	0.8 (41)	1.2 (66)	2.7 (231)	0.1 (11)	2.9 (242)	0.0 (2)	1.5 (129)	0.5 (45)	2.1 (176)	
FEB	2.4 (130)	0.0 (0)	2.4 (130)	0.0 (0)	0.1 (3)	0.7 (39)	1.0 (53)	1.7 (94)	2.4 (201)	0.1 (9)	2.5 (209)	0.0 (2)	1.5 (130)	0.6 (54)	2.2 (187)	
MAR	1.9 (103)	0.0 (0)	1.9 (103)	0.0 (0)	0.0 (0)	0.9 (49)	1.5 (80)	2.4 (129)	1.9 (159)	0.4 (34)	2.3 (193)	0.0 (1)	1.6 (132)	1.0 (83)	2.6 (216)	
APR	1.2 (65)	0.0 (0)	1.2 (65)	0.0 (0)	0.0 (0)	0.7 (37)	1.9 (100)	2.5 (137)	1.2 (100)	0.8 (65)	2.0 (165)	0.0 (0)	1.1 (96)	1.2 (105)	2.4 (201)	
MAY	0.4 (21)	0.0 (0)	0.4 (21)	0.0 (0)	0.0 (0)	0.4 (24)	1.6 (85)	2.0 (109)	0.4 (32)	1.0 (84)	1.4 (116)	0.0 (0)	0.7 (58)	1.3 (110)	2.0 (168)	
JUN	0.1 (5)	0.0 (0)	0.1 (5)	0.0 (0)	0.0 (0)	0.3 (17)	0.4 (22)	0.7 (39)	0.1 (8)	1.2 (100)	1.3 (109)	0.0 (0)	0.5 (38)	1.2 (100)	1.6 (139)	
JUL	0.0 (2)	0.0 (0)	0.0 (2)	0.0 (0)	0.0 (0)	0.2 (13)	0.0 (2)	0.3 (15)	0.0 (3)	1.2 (103)	1.3 (107)	0.0 (0)	0.4 (31)	1.1 (94)	1.5 (126)	
AUG	0.1 (7)	0.0 (0)	0.1 (7)	0.0 (0)	0.0 (0)	0.2 (11)	0.1 (5)	0.3 (16)	0.1 (10)	1.1 (96)	1.3 (107)	0.0 (0)	0.3 (29)	1.1 (90)	1.4 (120)	
SEP	0.3 (18)	0.0 (0)	0.3 (18)	0.0 (0)	0.0 (0)	0.2 (8)	0.2 (13)	0.4 (22)	0.3 (27)	0.8 (70)	1.2 (97)	0.0 (0)	0.4 (30)	0.9 (76)	1.3 (106)	
Total	13.7 (740)	0.0 (0)	13.7 (740)	0.0 (0)	0.1 (4)	4.6 (251)	9.1 (491)	13.8 (745)	13.6 (1145)	7.7 (648)	21.2 (1792)	0.1 (8)	10.3 (867)	10.8 (912)	21.2 (1787)	

## Wet Period

	Pre-Development <sup>2</sup>								Post-Development with PDFs <sup>3</sup>							
	INFLOW			OUTFLOW					INFLOW			OUTFLOW				
	Precipitation	Irrigation	Total	Quarry Runoff Recirculation	Runoff to SJ Crk	GW Outflow	ET	Total	Precipitation	Irrigation	Total	Runoff to SJ Crk	GW Outflow	ET	Total	
OCT	0.3 (17)	0.0 (0)	0.3 (17)	0.0 (0)	0.0 (0)	0.2 (12)	0.2 (13)	0.5 (25)	0.3 (27)	0.5 (44)	0.8 (71)	0.0 (0)	0.4 (32)	0.7 (59)	1.1 (91)	
NOV	1.4 (75)	0.0 (0)	1.4 (75)	0.0 (0)	0.0 (0)	0.2 (10)	0.5 (27)	0.7 (37)	1.4 (116)	0.2 (19)	1.6 (135)	0.0 (1)	0.7 (56)	0.6 (49)	1.2 (105)	
DEC	1.9 (104)	0.0 (0)	1.9 (104)	0.0 (0)	0.0 (0)	0.3 (17)	0.6 (33)	0.9 (51)	1.9 (161)	0.2 (14)	2.1 (175)	0.0 (1)	1.1 (91)	0.5 (43)	1.6 (134)	
JAN	5.7 (309)	0.0 (0)	5.7 (309)	0.0 (0)	0.1 (7)	1.3 (71)	0.7 (40)	2.2 (118)	5.7 (478)	0.1 (11)	5.8 (489)	0.1 (6)	2.9 (244)	0.6 (47)	3.5 (297)	
FEB	5.6 (302)	0.0 (0)	5.6 (302)	0.0 (0)	0.4 (20)	2.3 (124)	1.0 (52)	3.6 (196)	5.5 (468)	0.1 (9)	5.6 (476)	0.1 (12)	3.5 (300)	0.7 (56)	4.4 (368)	
MAR	4.8 (262)	0.0 (0)	4.8 (262)	0.0 (0)	0.0 (2)	3.2 (175)	1.5 (79)	4.7 (256)	4.8 (405)	0.4 (33)	5.2 (439)	0.1 (5)	4.2 (357)	1.0 (84)	5.3 (446)	
APR	1.1 (58)	0.0 (0)	1.1 (58)	0.0 (0)	0.0 (0)	2.0 (106)	2.0 (106)	3.9 (212)	1.1 (89)	0.8 (66)	1.8 (155)	0.0 (1)	2.0 (173)	1.3 (108)	3.3 (282)	
MAY	0.4 (21)	0.0 (0)	0.4 (21)	0.0 (0)	0.0 (0)	1.2 (64)	1.3 (69)	2.4 (132)	0.4 (33)	1.0 (85)	1.4 (118)	0.0 (1)	1.2 (104)	1.3 (107)	2.5 (211)	
JUN	0.2 (12)	0.0 (0)	0.2 (12)	0.0 (0)	0.0 (0)	0.7 (40)	0.4 (22)	1.1 (62)	0.2 (18)	1.2 (101)	1.4 (119)	0.0 (0)	0.8 (66)	1.2 (99)	2.0 (165)	
JUL	0.0 (1)	0.0 (0)	0.0 (1)	0.0 (0)	0.0 (0)	0.5 (29)	0.0 (1)	0.6 (30)	0.0 (1)	1.2 (103)	1.2 (104)	0.0 (0)	0.6 (48)	1.1 (94)	1.7 (142)	
AUG	0.1 (4)	0.0 (0)	0.1 (4)	0.0 (0)	0.0 (0)	0.4 (22)	0.1 (4)	0.5 (26)	0.1 (7)	1.1 (96)	1.2 (103)	0.0 (0)	0.5 (39)	1.1 (90)	1.5 (129)	
SEP	0.4 (21)	0.0 (0)	0.4 (21)	0.0 (0)	0.0 (0)	0.3 (16)	0.2 (13)	0.5 (29)	0.4 (32)	0.8 (70)	1.2 (101)	0.0 (0)	0.4 (37)	0.9 (76)	1.3 (113)	
Total	21.9 (1187)	0.0 (0)	21.9 (1187)	0.0 (0)	0.5 (29)	12.7 (687)	8.5 (459)	21.7 (1174)	21.7 (1835)	7.7 (650)	29.4 (2486)	0.3 (26)	18.3 (1546)	10.8 (911)	29.4 (2483)	

### Notes:

- (1) This includes the catchments located south of San Juan Creek that drain to Trampas Creek. The existing quarry was excluded for pre-development conditions because runoff from these areas drains to a terminal pond. After the construction of PA5, areas once draining to the terminal pond will be diverted to Trampas Creek. Because of this, the area tributary to Trampas Creek significantly increases from pre to post-development conditions.
- (2) The pre-development catchments include Catchments 22 and the portions of Catchments 23 and 25 that drain to Trampas Creek.
- (3) The post-development catchments include Catchments PA5-3, PA5-4, 25a, and 25b.

# Central San Juan (Alternative B-4) – Trampas Creek: Pre-Quarry Conditions<sup>1</sup>

Pre-dev area = 1059 acres

Post-dev area = 1013 acres

## All Years

	Pre-Development <sup>2</sup>					Post-Development with PDFs <sup>3</sup>						
	INFLOW	OUTFLOW				INFLOW			OUTFLOW			
	Precipitation	Runoff to SJ Crk	GW Outflow	ET	Total	Precipitation	Irrigation	Total	Runoff to SJ Crk	GW Outflow	ET	Total
OCT	0.3 (29)	0.0 (0)	0.2 (15)	0.3 (28)	0.5 (43)	0.3 (27)	0.5 (44)	0.8 (71)	0.0 (0)	0.3 (29)	0.7 (60)	1.1 (90)
NOV	1.7 (150)	0.0 (0)	0.1 (13)	0.5 (48)	0.7 (62)	1.7 (140)	0.2 (19)	1.9 (158)	0.0 (1)	0.7 (62)	0.6 (50)	1.3 (113)
DEC	2.2 (198)	0.0 (0)	0.3 (25)	0.6 (57)	0.9 (82)	2.2 (184)	0.2 (14)	2.3 (198)	0.0 (1)	1.2 (97)	0.5 (43)	1.7 (142)
JAN	3.7 (333)	0.0 (4)	0.8 (67)	0.7 (64)	1.5 (134)	3.7 (310)	0.1 (11)	3.8 (321)	0.0 (3)	2.0 (166)	0.5 (46)	2.5 (215)
FEB	3.4 (308)	0.2 (14)	1.3 (113)	0.9 (82)	2.3 (208)	3.4 (286)	0.1 (9)	3.5 (295)	0.1 (6)	2.2 (184)	0.7 (55)	2.9 (245)
MAR	2.9 (256)	0.0 (1)	1.7 (152)	1.4 (124)	3.1 (277)	2.8 (238)	0.4 (34)	3.2 (272)	0.0 (2)	2.4 (204)	1.0 (83)	3.4 (290)
APR	1.2 (104)	0.0 (0)	1.1 (101)	1.8 (161)	2.9 (263)	1.1 (97)	0.8 (65)	1.9 (162)	0.0 (0)	1.4 (120)	1.3 (106)	2.7 (227)
MAY	0.4 (35)	0.0 (0)	0.7 (63)	1.6 (140)	2.3 (203)	0.4 (32)	1.0 (84)	1.4 (116)	0.0 (0)	0.9 (73)	1.3 (109)	2.2 (182)
JUN	0.1 (12)	0.0 (0)	0.5 (41)	0.5 (47)	1.0 (88)	0.1 (11)	1.2 (100)	1.3 (112)	0.0 (0)	0.6 (47)	1.2 (100)	1.7 (147)
JUL	0.0 (3)	0.0 (0)	0.3 (31)	0.0 (3)	0.4 (35)	0.0 (3)	1.2 (103)	1.3 (106)	0.0 (0)	0.4 (37)	1.1 (94)	1.6 (131)
AUG	0.1 (10)	0.0 (0)	0.3 (24)	0.1 (8)	0.4 (32)	0.1 (9)	1.1 (96)	1.3 (106)	0.0 (0)	0.4 (32)	1.1 (90)	1.5 (123)
SEP	0.3 (31)	0.0 (0)	0.2 (18)	0.2 (21)	0.4 (39)	0.3 (29)	0.8 (70)	1.2 (99)	0.0 (0)	0.4 (32)	0.9 (76)	1.3 (108)
<b>Total</b>	<b>16.4 (1468)</b>	<b>0.2 (19)</b>	<b>7.4 (664)</b>	<b>8.8 (783)</b>	<b>16.4 (1466)</b>	<b>16.2 (1366)</b>	<b>7.7 (649)</b>	<b>23.9 (2015)</b>	<b>0.2 (14)</b>	<b>12.8 (1085)</b>	<b>10.8 (912)</b>	<b>23.8 (2010)</b>

## Dry Period

	Pre-Development <sup>2</sup>					Post-Development with PDFs <sup>3</sup>						
	INFLOW	OUTFLOW				INFLOW			OUTFLOW			
	Precipitation	Runoff to SJ Crk	GW Outflow	ET	Total	Precipitation	Irrigation	Total	Runoff to SJ Crk	GW Outflow	ET	Total
OCT	0.3 (29)	0.0 (0)	0.1 (13)	0.3 (31)	0.5 (44)	0.3 (27)	0.5 (44)	0.8 (71)	0.0 (0)	0.3 (28)	0.7 (61)	1.1 (89)
NOV	1.8 (162)	0.0 (0)	0.1 (12)	0.6 (51)	0.7 (63)	1.8 (150)	0.2 (18)	2.0 (169)	0.0 (0)	0.8 (66)	0.6 (50)	1.4 (116)
DEC	2.4 (210)	0.0 (0)	0.3 (23)	0.7 (59)	0.9 (82)	2.3 (195)	0.2 (14)	2.5 (209)	0.0 (1)	1.2 (100)	0.5 (43)	1.7 (145)
JAN	2.8 (248)	0.0 (0)	0.5 (42)	0.7 (64)	1.2 (106)	2.7 (231)	0.1 (11)	2.9 (242)	0.0 (2)	1.5 (129)	0.5 (45)	2.1 (176)
FEB	2.4 (216)	0.1 (5)	0.7 (67)	0.9 (82)	1.7 (155)	2.4 (201)	0.1 (9)	2.5 (209)	0.0 (2)	1.5 (130)	0.6 (54)	2.2 (187)
MAR	1.9 (170)	0.0 (0)	0.9 (85)	1.4 (124)	2.3 (209)	1.9 (159)	0.4 (34)	2.3 (193)	0.0 (1)	1.6 (132)	1.0 (83)	2.6 (216)
APR	1.2 (108)	0.0 (0)	0.7 (64)	1.8 (158)	2.5 (223)	1.2 (100)	0.8 (65)	2.0 (165)	0.0 (0)	1.1 (96)	1.2 (105)	2.4 (201)
MAY	0.4 (34)	0.0 (0)	0.5 (42)	1.7 (148)	2.1 (190)	0.4 (32)	1.0 (84)	1.4 (116)	0.0 (0)	0.7 (58)	1.3 (110)	2.0 (168)
JUN	0.1 (9)	0.0 (0)	0.3 (29)	0.6 (49)	0.9 (78)	0.1 (8)	1.2 (100)	1.3 (109)	0.0 (0)	0.5 (38)	1.2 (100)	1.6 (139)
JUL	0.0 (4)	0.0 (0)	0.3 (23)	0.0 (4)	0.3 (27)	0.0 (3)	1.2 (103)	1.3 (107)	0.0 (0)	0.4 (31)	1.1 (94)	1.5 (126)
AUG	0.1 (11)	0.0 (0)	0.2 (18)	0.1 (9)	0.3 (27)	0.1 (10)	1.1 (96)	1.3 (107)	0.0 (0)	0.3 (29)	1.1 (90)	1.4 (120)
SEP	0.3 (29)	0.0 (0)	0.2 (14)	0.2 (21)	0.4 (36)	0.3 (27)	0.8 (70)	1.2 (97)	0.0 (0)	0.4 (30)	0.9 (76)	1.3 (106)
<b>Total</b>	<b>13.8 (1230)</b>	<b>0.1 (6)</b>	<b>4.8 (430)</b>	<b>9.0 (800)</b>	<b>13.9 (1237)</b>	<b>13.6 (1145)</b>	<b>7.7 (648)</b>	<b>21.2 (1792)</b>	<b>0.1 (8)</b>	<b>10.3 (867)</b>	<b>10.8 (912)</b>	<b>21.2 (1787)</b>

## Wet Period

	Pre-Development <sup>2</sup>					Post-Development with PDFs <sup>3</sup>						
	INFLOW	OUTFLOW				INFLOW			OUTFLOW			
	Precipitation	Runoff to SJ Crk	GW Outflow	ET	Total	Precipitation	Irrigation	Total	Runoff to SJ Crk	GW Outflow	ET	Total
OCT	0.3 (29)	0.0 (0)	0.2 (20)	0.2 (21)	0.5 (41)	0.3 (27)	0.5 (44)	0.8 (71)	0.0 (0)	0.4 (32)	0.7 (59)	1.1 (91)
NOV	1.4 (125)	0.0 (0)	0.2 (16)	0.5 (43)	0.7 (60)	1.4 (116)	0.2 (19)	1.6 (135)	0.0 (1)	0.7 (56)	0.6 (49)	1.2 (105)
DEC	1.9 (173)	0.0 (0)	0.3 (28)	0.6 (53)	0.9 (81)	1.9 (161)	0.2 (14)	2.1 (175)	0.0 (1)	1.1 (91)	0.5 (43)	1.6 (134)
JAN	5.8 (514)	0.1 (11)	1.3 (120)	0.7 (63)	2.2 (194)	5.7 (478)	0.1 (11)	5.8 (489)	0.1 (6)	2.9 (244)	0.6 (47)	3.5 (297)
FEB	5.6 (503)	0.4 (33)	2.4 (210)	0.9 (81)	3.6 (325)	5.5 (468)	0.1 (9)	5.6 (476)	0.1 (12)	3.5 (300)	0.7 (56)	4.4 (368)
MAR	4.9 (436)	0.0 (2)	3.3 (296)	1.4 (123)	4.7 (421)	4.8 (405)	0.4 (33)	5.2 (439)	0.1 (5)	4.2 (357)	1.0 (84)	5.3 (446)
APR	1.1 (96)	0.0 (0)	2.0 (180)	1.9 (167)	3.9 (347)	1.1 (89)	0.8 (66)	1.8 (155)	0.0 (1)	2.0 (173)	1.3 (108)	3.3 (282)
MAY	0.4 (35)	0.0 (0)	1.2 (108)	1.4 (124)	2.6 (232)	0.4 (35)	1.0 (85)	1.4 (118)	0.0 (1)	1.2 (104)	1.3 (107)	2.5 (211)
JUN	0.2 (20)	0.0 (0)	0.8 (67)	0.5 (42)	1.2 (109)	0.2 (18)	1.2 (101)	1.4 (119)	0.0 (0)	0.8 (66)	1.2 (99)	2.0 (165)
JUL	0.0 (1)	0.0 (0)	0.5 (49)	0.0 (1)	0.6 (50)	0.0 (1)	1.2 (103)	1.2 (104)	0.0 (0)	0.6 (48)	1.1 (94)	1.7 (142)
AUG	0.1 (7)	0.0 (0)	0.4 (36)	0.1 (7)	0.5 (44)	0.1 (7)	1.1 (96)	1.2 (103)	0.0 (0)	0.5 (39)	1.1 (90)	1.5 (129)
SEP	0.4 (34)	0.0 (0)	0.3 (27)	0.2 (20)	0.5 (48)	0.4 (32)	0.8 (70)	1.2 (101)	0.0 (0)	0.4 (37)	0.9 (76)	1.3 (113)
<b>Total</b>	<b>22.1 (1973)</b>	<b>0.5 (46)</b>	<b>13.0 (1159)</b>	<b>8.4 (747)</b>	<b>21.9 (1952)</b>	<b>21.7 (1835)</b>	<b>7.7 (650)</b>	<b>29.4 (2486)</b>	<b>0.3 (26)</b>	<b>18.3 (1546)</b>	<b>10.8 (911)</b>	<b>29.4 (2483)</b>

### Notes:

- (1) This includes the catchments located south of San Juan Creek that drain to Trampas Creek. The purpose of this table is to show the impacts of the proposed development when compared to pre-quarry conditions. Due to the grading of PA5, the tributary area of Trampas Creek decrease with development.
- (2) The pre-development catchments include Catchments 22, 23 and 25.
- (3) The post-development catchments include Catchments PA5-3, PA5-4, 25a, and 25b.

# Central San Juan – Quarry Area<sup>1</sup>

Pre-dev area = 421 acres

Post-dev area = 0 acres

## All Years

	Pre-Development <sup>2</sup>								Post-Development with PDFs <sup>3</sup>						
	INFLOW			OUTFLOW					INFLOW			OUTFLOW			
	Precipitation	Irrigation	Total	Quarry Runoff Recirculation	Runoff to SJ Crk	GW Outflow	ET	Total	Precipitation	Irrigation	Total	Runoff to SJ Crk	GW Outflow	ET	Total
OCT	0.3 (12)	0.0 (0)	0.3 (12)	0.0 (1)	0.0 (0)	0.2 (6)	0.2 (8)	0.4 (16)							
NOV	1.7 (60)	0.0 (0)	1.7 (60)	0.2 (8)	0.0 (0)	0.2 (6)	0.4 (13)	0.8 (27)							
DEC	2.2 (79)	0.0 (0)	2.2 (79)	0.3 (10)	0.0 (0)	0.4 (12)	0.4 (15)	1.1 (37)							
JAN	3.8 (133)	0.0 (0)	3.8 (133)	0.5 (18)	0.0 (0)	0.8 (30)	0.5 (17)	1.8 (65)							
FEB	3.5 (123)	0.0 (0)	3.5 (123)	0.6 (21)	0.0 (0)	1.3 (46)	0.6 (21)	2.5 (88)							
MAR	2.9 (102)	0.0 (0)	2.9 (102)	0.4 (13)	0.0 (0)	1.7 (61)	0.9 (32)	3.0 (106)							
APR	1.2 (41)	0.0 (0)	1.2 (41)	0.1 (5)	0.0 (0)	1.2 (41)	1.2 (42)	2.5 (88)							
MAY	0.4 (14)	0.0 (0)	0.4 (14)	0.0 (2)	0.0 (0)	0.7 (26)	1.2 (43)	2.0 (71)							
JUN	0.1 (5)	0.0 (0)	0.1 (5)	0.0 (1)	0.0 (0)	0.5 (17)	0.7 (24)	1.2 (41)							
JUL	0.0 (1)	0.0 (0)	0.0 (1)	0.0 (0)	0.0 (0)	0.3 (12)	0.1 (4)	0.5 (17)							
AUG	0.1 (4)	0.0 (0)	0.1 (4)	0.0 (0)	0.0 (0)	0.3 (9)	0.1 (4)	0.4 (13)							
SEP	0.4 (12)	0.0 (0)	0.4 (12)	0.0 (2)	0.0 (0)	0.2 (7)	0.2 (7)	0.4 (15)							
Total	16.7 (585)	0.0 (0)	16.7 (585)	2.3 (81)	0.0 (0)	7.8 (274)	6.5 (229)	16.6 (583)							

## Dry Period

	Pre-Development <sup>2</sup>								Post-Development with PDFs <sup>3</sup>						
	INFLOW			OUTFLOW					INFLOW			OUTFLOW			
	Precipitation	Irrigation	Total	Quarry Runoff Recirculation	Runoff to SJ Crk	GW Outflow	ET	Total	Precipitation	Irrigation	Total	Runoff to SJ Crk	GW Outflow	ET	Total
OCT	0.3 (12)	0.0 (0)	0.3 (12)	0.0 (1)	0.0 (0)	0.2 (6)	0.2 (9)	0.4 (16)							
NOV	1.8 (64)	0.0 (0)	1.8 (64)	0.2 (8)	0.0 (0)	0.2 (6)	0.4 (14)	0.8 (28)							
DEC	2.4 (84)	0.0 (0)	2.4 (84)	0.3 (11)	0.0 (0)	0.3 (12)	0.4 (15)	1.1 (38)							
JAN	2.8 (99)	0.0 (0)	2.8 (99)	0.4 (13)	0.0 (0)	0.6 (20)	0.5 (17)	1.4 (50)							
FEB	2.4 (86)	0.0 (0)	2.4 (86)	0.4 (13)	0.0 (0)	0.8 (30)	0.6 (21)	1.8 (63)							
MAR	1.9 (68)	0.0 (0)	1.9 (68)	0.2 (9)	0.0 (0)	1.0 (36)	0.9 (32)	2.2 (77)							
APR	1.2 (43)	0.0 (0)	1.2 (43)	0.2 (5)	0.0 (0)	0.8 (28)	1.2 (41)	2.1 (75)							
MAY	0.4 (14)	0.0 (0)	0.4 (14)	0.0 (2)	0.0 (0)	0.5 (19)	1.2 (44)	1.8 (64)							
JUN	0.1 (4)	0.0 (0)	0.1 (4)	0.0 (0)	0.0 (0)	0.4 (13)	0.7 (26)	1.1 (39)							
JUL	0.0 (1)	0.0 (0)	0.0 (1)	0.0 (0)	0.0 (0)	0.3 (10)	0.1 (5)	0.4 (15)							
AUG	0.1 (4)	0.0 (0)	0.1 (4)	0.0 (1)	0.0 (0)	0.2 (8)	0.1 (4)	0.3 (12)							
SEP	0.3 (12)	0.0 (0)	0.3 (12)	0.0 (1)	0.0 (0)	0.2 (6)	0.2 (7)	0.4 (14)							
Total	14.0 (490)	0.0 (0)	14.0 (490)	1.8 (64)	0.0 (0)	5.5 (193)	6.6 (233)	14.0 (490)							

## Wet Period

	Pre-Development <sup>2</sup>								Post-Development with PDFs <sup>3</sup>						
	INFLOW			OUTFLOW					INFLOW			OUTFLOW			
	Precipitation	Irrigation	Total	Quarry Runoff Recirculation	Runoff to SJ Crk	GW Outflow	ET	Total	Precipitation	Irrigation	Total	Runoff to SJ Crk	GW Outflow	ET	Total
OCT	0.3 (12)	0.0 (0)	0.3 (12)	0.0 (1)	0.0 (0)	0.2 (8)	0.2 (7)	0.5 (16)							
NOV	1.4 (50)	0.0 (0)	1.4 (50)	0.2 (6)	0.0 (0)	0.2 (7)	0.3 (12)	0.7 (25)							
DEC	2.0 (69)	0.0 (0)	2.0 (69)	0.3 (9)	0.0 (0)	0.4 (13)	0.4 (14)	1.0 (36)							
JAN	5.8 (205)	0.0 (0)	5.8 (205)	0.9 (30)	0.0 (0)	1.4 (49)	0.5 (17)	2.7 (96)							
FEB	5.7 (200)	0.0 (0)	5.7 (200)	1.1 (38)	0.0 (0)	2.3 (80)	0.6 (21)	4.0 (139)							
MAR	4.9 (173)	0.0 (0)	4.9 (173)	0.6 (22)	0.0 (0)	3.2 (113)	0.9 (32)	4.7 (167)							
APR	1.1 (38)	0.0 (0)	1.1 (38)	0.1 (5)	0.0 (0)	2.0 (69)	1.2 (42)	3.3 (116)							
MAY	0.4 (14)	0.0 (0)	0.4 (14)	0.0 (2)	0.0 (0)	1.2 (41)	1.2 (42)	2.4 (85)							
JUN	0.2 (8)	0.0 (0)	0.2 (8)	0.0 (1)	0.0 (0)	0.7 (25)	0.6 (20)	1.3 (46)							
JUL	0.0 (0)	0.0 (0)	0.0 (0)	0.0 (0)	0.0 (0)	0.5 (18)	0.1 (3)	0.6 (20)							
AUG	0.1 (3)	0.0 (0)	0.1 (3)	0.0 (0)	0.0 (0)	0.4 (13)	0.1 (4)	0.5 (17)							
SEP	0.4 (14)	0.0 (0)	0.4 (14)	0.0 (2)	0.0 (0)	0.3 (10)	0.2 (7)	0.5 (18)							
Total	22.4 (786)	0.0 (0)	22.4 (786)	3.3 (116)	0.0 (0)	12.7 (444)	6.3 (220)	22.2 (781)							

### Notes:

- (1) This includes the existing sand and gravel quarry located in portions of Catchments 23 and 25. These areas drain to an onsite terminal pond and do not contribute flows to Trampas Creek or San Juan Creek. After the construction of PA5, the quarry pond will be graded over, and flows generated from the area will drain to Trampas Creek. Because of this, there are no flows generated from the quarry for developed conditions.
- (2) The pre-development catchments includes portions of Catchments 23 and 25 that drain to the onsite terminal pond.
- (3) The quarry will be graded over after the construction of PA5. Because of this, no flows are generated from the quarry during the developed conditions.

# Central San Juan (Alternative B-4) – South CSJ/PA5<sup>1</sup>

Pre-dev area = 597 acres

Post-dev area = 741 acres

## All Years

	Pre-Development <sup>2</sup>								Post-Development with PDFs <sup>3</sup>							
	INFLOW			OUTFLOW					INFLOW			OUTFLOW				
	Precipitation	Irrigation	Total	Quarry Runoff Recirculation	Runoff to SJ Crk	GW Outflow	ET	Total	Precipitation	Irrigation	Total	Runoff to SJ Crk	GW Outflow	ET	Total	
OCT	0.3 (16)	0.0 (0)	0.3 (16)	0.0 (0)	0.0 (0)	0.2 (12)	0.3 (14)	0.5 (26)	0.3 (20)	0.4 (26)	0.7 (46)	0.0 (1)	0.4 (23)	0.6 (38)	1.0 (61)	
NOV	1.6 (82)	0.0 (0)	1.6 (82)	0.0 (0)	0.1 (3)	0.2 (11)	0.5 (24)	0.7 (37)	1.7 (103)	0.2 (11)	1.8 (114)	0.1 (5)	0.7 (40)	0.6 (34)	1.3 (80)	
DEC	2.2 (108)	0.0 (0)	2.2 (108)	0.0 (0)	0.2 (9)	0.4 (17)	0.6 (28)	1.1 (54)	2.2 (136)	0.1 (8)	2.3 (144)	0.2 (11)	1.0 (59)	0.5 (33)	1.7 (103)	
JAN	3.6 (181)	0.0 (0)	3.6 (181)	0.0 (0)	0.5 (26)	0.7 (37)	0.7 (32)	1.9 (95)	3.7 (228)	0.1 (7)	3.8 (235)	0.5 (29)	1.5 (96)	0.6 (36)	2.6 (161)	
FEB	3.4 (167)	0.0 (0)	3.4 (167)	0.0 (0)	0.6 (32)	1.1 (56)	0.8 (41)	2.6 (128)	3.4 (211)	0.1 (5)	3.5 (216)	0.5 (33)	1.7 (108)	0.7 (42)	3.0 (183)	
MAR	2.8 (139)	0.0 (0)	2.8 (139)	0.0 (0)	0.5 (24)	1.5 (73)	1.1 (55)	3.0 (151)	2.8 (175)	0.3 (21)	3.2 (196)	0.4 (24)	2.0 (123)	1.0 (63)	3.4 (210)	
APR	1.1 (57)	0.0 (0)	1.1 (57)	0.0 (0)	0.1 (5)	1.0 (52)	1.3 (64)	2.4 (121)	1.2 (71)	0.6 (39)	1.8 (110)	0.1 (4)	1.3 (79)	1.2 (73)	2.5 (156)	
MAY	0.4 (19)	0.0 (0)	0.4 (19)	0.0 (0)	0.0 (1)	0.7 (36)	1.1 (54)	1.8 (91)	0.4 (24)	0.8 (51)	1.2 (74)	0.0 (1)	0.8 (50)	1.2 (71)	2.0 (123)	
JUN	0.1 (7)	0.0 (0)	0.1 (7)	0.0 (0)	0.0 (0)	0.5 (25)	0.4 (22)	1.0 (48)	0.1 (8)	1.0 (61)	1.1 (69)	0.0 (0)	0.6 (35)	1.0 (61)	1.6 (96)	
JUL	0.0 (2)	0.0 (0)	0.0 (2)	0.0 (0)	0.0 (0)	0.4 (20)	0.0 (2)	0.5 (23)	0.0 (2)	1.0 (62)	1.0 (64)	0.0 (0)	0.5 (29)	0.9 (55)	1.4 (84)	
AUG	0.1 (5)	0.0 (0)	0.1 (5)	0.0 (0)	0.0 (0)	0.3 (17)	0.1 (4)	0.4 (21)	0.1 (7)	0.9 (58)	1.1 (65)	0.0 (0)	0.4 (26)	0.8 (52)	1.3 (78)	
SEP	0.3 (17)	0.0 (0)	0.3 (17)	0.0 (0)	0.0 (0)	0.3 (14)	0.2 (10)	0.5 (24)	0.3 (21)	0.7 (42)	1.0 (63)	0.0 (1)	0.4 (25)	0.7 (45)	1.2 (71)	
Total	16.1 (798)	0.0 (0)	16.1 (798)	0.0 (0)	2.0 (100)	7.4 (368)	7.0 (350)	16.5 (818)	16.3 (1005)	6.4 (392)	22.6 (1397)	1.8 (109)	11.2 (694)	9.8 (602)	22.8 (1406)	

## Dry Period

	Pre-Development <sup>2</sup>								Post-Development with PDFs <sup>3</sup>							
	INFLOW			OUTFLOW					INFLOW			OUTFLOW				
	Precipitation	Irrigation	Total	Quarry Runoff Recirculation	Runoff to SJ Crk	GW Outflow	ET	Total	Precipitation	Irrigation	Total	Runoff to SJ Crk	GW Outflow	ET	Total	
OCT	0.3 (16)	0.0 (0)	0.3 (16)	0.0 (0)	0.0 (0)	0.2 (11)	0.3 (16)	0.5 (27)	0.3 (20)	0.4 (26)	0.7 (46)	0.0 (1)	0.4 (22)	0.6 (38)	1.0 (61)	
NOV	1.8 (88)	0.0 (0)	1.8 (88)	0.0 (0)	0.1 (3)	0.2 (10)	0.5 (25)	0.8 (38)	1.8 (111)	0.2 (11)	2.0 (122)	0.1 (6)	0.7 (42)	0.6 (35)	1.3 (83)	
DEC	2.3 (114)	0.0 (0)	2.3 (114)	0.0 (0)	0.2 (9)	0.3 (17)	0.6 (29)	1.1 (55)	2.3 (144)	0.1 (8)	2.5 (152)	0.2 (12)	1.0 (61)	0.5 (33)	1.7 (106)	
JAN	2.7 (135)	0.0 (0)	2.7 (135)	0.0 (0)	0.3 (14)	0.5 (27)	0.6 (32)	1.5 (72)	2.8 (170)	0.1 (7)	2.9 (177)	0.3 (17)	1.2 (77)	0.6 (35)	2.1 (128)	
FEB	2.4 (117)	0.0 (0)	2.4 (117)	0.0 (0)	0.3 (17)	0.8 (38)	0.8 (40)	1.9 (94)	2.4 (148)	0.1 (5)	2.5 (153)	0.3 (16)	1.3 (80)	0.7 (41)	2.1 (137)	
MAR	1.9 (93)	0.0 (0)	1.9 (93)	0.0 (0)	0.2 (12)	0.9 (46)	1.1 (54)	2.3 (112)	1.9 (117)	0.3 (21)	2.2 (138)	0.2 (9)	1.4 (84)	1.0 (62)	2.5 (156)	
APR	1.2 (59)	0.0 (0)	1.2 (59)	0.0 (0)	0.1 (5)	0.7 (37)	1.3 (64)	2.1 (106)	1.2 (74)	0.6 (39)	1.8 (113)	0.1 (5)	1.0 (63)	1.2 (73)	2.3 (141)	
MAY	0.4 (19)	0.0 (0)	0.4 (19)	0.0 (0)	0.0 (0)	0.5 (27)	1.1 (57)	1.7 (84)	0.4 (23)	0.8 (51)	1.2 (74)	0.0 (1)	0.7 (41)	1.2 (73)	1.9 (115)	
JUN	0.1 (5)	0.0 (0)	0.1 (5)	0.0 (0)	0.0 (0)	0.4 (20)	0.5 (23)	0.9 (43)	0.1 (6)	1.0 (61)	1.1 (67)	0.0 (0)	0.5 (29)	1.0 (60)	1.5 (90)	
JUL	0.0 (2)	0.0 (0)	0.0 (2)	0.0 (0)	0.0 (0)	0.3 (17)	0.1 (3)	0.4 (19)	0.0 (3)	1.0 (62)	1.1 (65)	0.0 (0)	0.4 (25)	0.9 (55)	1.3 (81)	
AUG	0.1 (6)	0.0 (0)	0.1 (6)	0.0 (0)	0.0 (0)	0.3 (14)	0.1 (5)	0.4 (19)	0.1 (8)	0.9 (58)	1.1 (66)	0.0 (0)	0.4 (24)	0.8 (52)	1.2 (76)	
SEP	0.3 (16)	0.0 (0)	0.3 (16)	0.0 (0)	0.0 (0)	0.2 (12)	0.2 (10)	0.4 (22)	0.3 (20)	0.7 (42)	1.0 (62)	0.0 (1)	0.4 (23)	0.7 (45)	1.1 (69)	
Total	13.5 (669)	0.0 (0)	13.5 (669)	0.0 (0)	1.2 (61)	5.5 (273)	7.2 (357)	13.9 (691)	13.7 (843)	6.3 (392)	20.0 (1235)	1.1 (66)	9.2 (571)	9.8 (605)	20.1 (1242)	

## Wet Period

	Pre-Development <sup>2</sup>								Post-Development with PDFs <sup>3</sup>							
	INFLOW			OUTFLOW					INFLOW			OUTFLOW				
	Precipitation	Irrigation	Total	Quarry Runoff Recirculation	Runoff to SJ Crk	GW Outflow	ET	Total	Precipitation	Irrigation	Total	Runoff to SJ Crk	GW Outflow	ET	Total	
OCT	0.3 (16)	0.0 (0)	0.3 (16)	0.0 (0)	0.0 (0)	0.3 (14)	0.2 (11)	0.5 (25)	0.3 (20)	0.4 (27)	0.7 (46)	0.0 (0)	0.4 (25)	0.6 (36)	1.0 (61)	
NOV	1.4 (68)	0.0 (0)	1.4 (68)	0.0 (0)	0.0 (1)	0.2 (12)	0.4 (21)	0.7 (34)	1.4 (85)	0.2 (11)	1.6 (96)	0.1 (4)	0.6 (37)	0.5 (33)	1.2 (74)	
DEC	1.9 (94)	0.0 (0)	1.9 (94)	0.0 (0)	0.2 (8)	0.4 (19)	0.5 (25)	1.1 (53)	1.9 (118)	0.1 (8)	2.0 (126)	0.2 (9)	0.9 (56)	0.5 (31)	1.6 (97)	
JAN	5.6 (279)	0.0 (0)	5.6 (279)	0.0 (0)	1.1 (52)	1.2 (58)	0.7 (33)	2.9 (143)	5.7 (351)	0.1 (7)	5.8 (358)	0.9 (56)	2.2 (136)	0.6 (37)	3.7 (229)	
FEB	5.5 (273)	0.0 (0)	5.5 (273)	0.0 (0)	1.3 (64)	1.9 (94)	0.9 (42)	4.0 (200)	5.6 (344)	0.1 (5)	5.6 (349)	1.1 (69)	2.7 (168)	0.7 (45)	4.6 (281)	
MAR	4.8 (237)	0.0 (0)	4.8 (237)	0.0 (0)	1.0 (50)	2.6 (129)	1.1 (56)	4.7 (235)	4.8 (298)	0.3 (20)	5.2 (318)	0.9 (55)	3.3 (206)	1.0 (65)	5.3 (326)	
APR	1.0 (52)	0.0 (0)	1.0 (52)	0.0 (0)	0.1 (5)	1.7 (83)	1.3 (64)	3.1 (152)	1.1 (65)	0.6 (40)	1.7 (105)	0.1 (4)	1.8 (111)	1.2 (72)	3.0 (187)	
MAY	0.4 (19)	0.0 (0)	0.4 (19)	0.0 (0)	0.0 (2)	1.1 (54)	1.0 (49)	2.1 (105)	0.4 (24)	0.8 (51)	1.2 (75)	0.0 (2)	1.1 (70)	1.1 (69)	2.3 (141)	
JUN	0.2 (11)	0.0 (0)	0.2 (11)	0.0 (0)	0.0 (0)	0.7 (36)	0.4 (20)	1.1 (56)	0.2 (13)	1.0 (61)	1.2 (74)	0.0 (0)	0.8 (47)	1.0 (62)	1.8 (109)	
JUL	0.0 (1)	0.0 (0)	0.0 (1)	0.0 (0)	0.0 (0)	0.6 (28)	0.0 (1)	0.6 (29)	0.0 (1)	1.0 (62)	1.0 (63)	0.0 (0)	0.6 (37)	0.9 (54)	1.5 (91)	
AUG	0.1 (4)	0.0 (0)	0.1 (4)	0.0 (0)	0.0 (0)	0.4 (22)	0.1 (4)	0.5 (26)	0.1 (5)	0.9 (58)	1.0 (63)	0.0 (0)	0.5 (32)	0.8 (51)	1.3 (83)	
SEP	0.4 (19)	0.0 (0)	0.4 (19)	0.0 (0)	0.0 (0)	0.4 (18)	0.2 (9)	0.5 (27)	0.4 (23)	0.7 (42)	1.1 (65)	0.0 (1)	0.5 (29)	0.7 (44)	1.2 (75)	
Total	21.6 (1073)	0.0 (0)	21.6 (1073)	0.0 (0)	3.7 (184)	11.4 (568)	6.7 (335)	21.9 (1087)	21.8 (1347)	6.4 (393)	28.2 (1740)	3.3 (201)	15.5 (955)	9.7 (597)	28.4 (1753)	

### Notes:

- (1) This includes all catchments south of San Juan Creek that drain to xx-Creek. Due to the grading plan of PA5, the total tributary area increases from pre to post development conditions.
- (2) The pre-development catchments include Catchments 13, 14, 17, 18 and 19.
- (3) The post-development catchments include Catchments 13, 14, 17, 18a, 18b, 19, 23, PA5-1, and PA5-2.

# Central San Juan (Alternative B-4) – North CSJ/PA3<sup>1</sup>

Pre-dev area = 1605 acres

Post-dev area = 1693 acres

## All Years

	Pre-Development <sup>2</sup>								Post-Development with PDEs <sup>3</sup>							
	INFLOW			OUTFLOW					INFLOW			OUTFLOW				
	Precipitation	Irrigation	Total	Quarry Runoff Recirculation	Runoff to SJ Crk	GW Outflow	ET	Total	Precipitation	Irrigation	Total	Runoff to SJ Crk	GW Outflow	ET	Total	
OCT	0.3 (40)	0.1 (18)	0.4 (57)	0.0 (0)	0.0 (2)	0.2 (30)	0.4 (56)	0.6 (87)	0.3 (43)	0.6 (78)	0.9 (121)	0.0 (1)	0.4 (53)	0.7 (102)	1.1 (156)	
NOV	1.5 (205)	0.1 (8)	1.6 (213)	0.0 (0)	0.1 (13)	0.2 (28)	0.5 (69)	0.8 (109)	1.6 (222)	0.2 (33)	1.8 (255)	0.1 (17)	0.7 (97)	0.6 (82)	1.4 (195)	
DEC	2.0 (271)	0.0 (5)	2.1 (276)	0.0 (0)	0.2 (23)	0.3 (46)	0.6 (74)	1.1 (143)	2.1 (294)	0.2 (24)	2.3 (318)	0.2 (27)	1.0 (143)	0.5 (70)	1.7 (240)	
JAN	3.4 (455)	0.0 (5)	3.4 (460)	0.0 (0)	0.4 (52)	0.7 (97)	0.6 (82)	1.7 (232)	3.5 (494)	0.1 (20)	3.6 (514)	0.4 (60)	1.6 (228)	0.5 (74)	2.6 (362)	
FEB	3.1 (420)	0.0 (4)	3.2 (425)	0.0 (0)	0.5 (70)	1.1 (142)	0.8 (106)	2.4 (319)	3.2 (456)	0.1 (15)	3.3 (472)	0.5 (69)	1.8 (250)	0.6 (90)	2.9 (409)	
MAR	2.6 (349)	0.1 (16)	2.7 (365)	0.0 (0)	0.4 (49)	1.4 (186)	1.1 (149)	2.9 (384)	2.7 (379)	0.4 (61)	3.1 (439)	0.3 (44)	2.0 (284)	0.9 (134)	3.3 (462)	
APR	1.1 (142)	0.2 (30)	1.3 (172)	0.0 (0)	0.1 (14)	1.0 (132)	1.2 (165)	2.3 (310)	1.1 (154)	0.8 (115)	1.9 (269)	0.1 (8)	1.3 (184)	1.1 (158)	2.5 (350)	
MAY	0.4 (47)	0.3 (38)	0.6 (85)	0.0 (0)	0.0 (3)	0.7 (89)	1.2 (156)	1.9 (249)	0.4 (51)	1.1 (149)	1.4 (200)	0.0 (2)	0.8 (117)	1.2 (166)	2.0 (285)	
JUN	0.1 (17)	0.3 (45)	0.5 (62)	0.0 (0)	0.0 (1)	0.5 (62)	0.9 (120)	1.4 (183)	0.1 (18)	1.3 (178)	1.4 (197)	0.0 (0)	0.6 (80)	1.2 (166)	1.7 (246)	
JUL	0.0 (4)	0.3 (45)	0.4 (49)	0.0 (0)	0.0 (0)	0.4 (50)	0.6 (77)	1.0 (127)	0.0 (4)	1.3 (183)	1.3 (188)	0.0 (0)	0.5 (64)	1.2 (165)	1.6 (230)	
AUG	0.1 (14)	0.3 (41)	0.4 (55)	0.0 (0)	0.0 (1)	0.3 (41)	0.4 (56)	0.7 (98)	0.1 (15)	1.2 (171)	1.3 (186)	0.0 (1)	0.4 (58)	1.1 (156)	1.5 (215)	
SEP	0.3 (42)	0.2 (29)	0.5 (71)	0.0 (0)	0.0 (2)	0.3 (34)	0.4 (55)	0.7 (90)	0.3 (46)	0.9 (124)	1.2 (170)	0.0 (2)	0.4 (57)	0.9 (129)	1.3 (188)	
Total	15.0 (2005)	2.1 (284)	17.1 (2289)	0.0 (0)	1.7 (228)	7.0 (937)	8.7 (1164)	17.4 (2330)	15.4 (2177)	8.2 (1151)	23.6 (3328)	1.6 (232)	11.4 (1614)	10.6 (1492)	23.7 (3338)	

## Dry Period

	Pre-Development <sup>2</sup>								Post-Development with PDEs <sup>3</sup>							
	INFLOW			OUTFLOW					INFLOW			OUTFLOW				
	Precipitation	Irrigation	Total	Quarry Runoff Recirculation	Runoff to SJ Crk	GW Outflow	ET	Total	Precipitation	Irrigation	Total	Runoff to SJ Crk	GW Outflow	ET	Total	
OCT	0.3 (40)	0.1 (18)	0.4 (57)	0.0 (0)	0.0 (2)	0.2 (25)	0.4 (59)	0.6 (86)	0.3 (43)	0.6 (78)	0.9 (121)	0.0 (1)	0.4 (50)	0.7 (103)	1.1 (154)	
NOV	1.7 (221)	0.1 (8)	1.7 (229)	0.0 (0)	0.1 (13)	0.2 (25)	0.5 (72)	0.8 (110)	1.7 (240)	0.2 (33)	1.9 (273)	0.1 (19)	0.7 (100)	0.6 (83)	1.4 (201)	
DEC	2.1 (287)	0.0 (5)	2.2 (292)	0.0 (0)	0.2 (24)	0.3 (43)	0.6 (76)	1.1 (144)	2.2 (311)	0.2 (24)	2.4 (335)	0.2 (29)	1.0 (146)	0.5 (71)	1.7 (246)	
JAN	2.5 (338)	0.0 (5)	2.6 (343)	0.0 (0)	0.2 (31)	0.5 (70)	0.6 (81)	1.4 (182)	2.6 (367)	0.1 (20)	2.7 (387)	0.3 (38)	1.3 (184)	0.5 (72)	2.1 (295)	
FEB	2.2 (295)	0.0 (4)	2.2 (299)	0.0 (0)	0.3 (36)	0.7 (95)	0.8 (103)	1.7 (233)	2.3 (320)	0.1 (15)	2.4 (335)	0.2 (33)	1.3 (188)	0.6 (87)	2.2 (309)	
MAR	1.7 (233)	0.1 (16)	1.9 (249)	0.0 (0)	0.2 (23)	0.9 (115)	1.1 (147)	2.1 (286)	1.8 (253)	0.4 (61)	2.2 (314)	0.1 (16)	1.4 (198)	0.9 (131)	2.4 (344)	
APR	1.1 (147)	0.2 (30)	1.3 (177)	0.0 (0)	0.1 (13)	0.7 (92)	1.3 (168)	2.0 (273)	1.1 (160)	0.8 (115)	1.9 (274)	0.1 (8)	1.1 (148)	1.1 (158)	2.2 (314)	
MAY	0.4 (47)	0.3 (38)	0.6 (85)	0.0 (0)	0.0 (2)	0.5 (65)	1.2 (161)	1.7 (228)	0.4 (51)	1.1 (148)	1.4 (199)	0.0 (2)	0.7 (95)	1.2 (168)	1.9 (265)	
JUN	0.1 (12)	0.3 (45)	0.4 (57)	0.0 (0)	0.0 (0)	0.3 (47)	0.9 (122)	1.3 (169)	0.1 (13)	1.3 (178)	1.4 (191)	0.0 (0)	0.5 (66)	1.2 (166)	1.6 (232)	
JUL	0.0 (5)	0.3 (45)	0.4 (50)	0.0 (0)	0.0 (0)	0.3 (39)	0.6 (80)	0.9 (119)	0.0 (5)	1.3 (183)	1.3 (189)	0.0 (0)	0.4 (55)	1.2 (166)	1.6 (221)	
AUG	0.1 (15)	0.3 (41)	0.4 (57)	0.0 (0)	0.0 (1)	0.2 (32)	0.4 (57)	0.7 (90)	0.1 (17)	1.2 (171)	1.3 (188)	0.0 (1)	0.4 (51)	1.1 (156)	1.5 (209)	
SEP	0.3 (40)	0.2 (29)	0.5 (69)	0.0 (0)	0.0 (2)	0.2 (27)	0.4 (56)	0.6 (84)	0.3 (43)	0.9 (124)	1.2 (168)	0.0 (3)	0.4 (52)	0.9 (130)	1.3 (184)	
Total	12.6 (1679)	2.1 (284)	14.7 (1963)	0.0 (0)	1.1 (148)	5.0 (674)	8.8 (1182)	15.0 (2005)	12.9 (1823)	8.2 (1150)	21.1 (2973)	1.1 (149)	9.5 (1333)	10.6 (1490)	21.1 (2973)	

## Wet Period

	Pre-Development <sup>2</sup>								Post-Development with PDEs <sup>3</sup>							
	INFLOW			OUTFLOW					INFLOW			OUTFLOW				
	Precipitation	Irrigation	Total	Quarry Runoff Recirculation	Runoff to SJ Crk	GW Outflow	ET	Total	Precipitation	Irrigation	Total	Runoff to SJ Crk	GW Outflow	ET	Total	
OCT	0.3 (39)	0.1 (18)	0.4 (57)	0.0 (0)	0.0 (1)	0.3 (39)	0.4 (49)	0.7 (89)	0.3 (43)	0.6 (78)	0.9 (121)	0.0 (1)	0.4 (60)	0.7 (100)	1.1 (161)	
NOV	1.3 (171)	0.1 (8)	1.3 (179)	0.0 (0)	0.1 (11)	0.3 (34)	0.5 (61)	0.8 (106)	1.3 (185)	0.2 (33)	1.5 (219)	0.1 (13)	0.6 (91)	0.6 (80)	1.3 (183)	
DEC	1.8 (236)	0.0 (5)	1.8 (242)	0.0 (0)	0.1 (19)	0.4 (53)	0.5 (68)	1.1 (141)	1.8 (257)	0.2 (24)	2.0 (281)	0.2 (23)	1.0 (137)	0.5 (69)	1.6 (229)	
JAN	5.2 (702)	0.0 (5)	5.3 (706)	0.0 (0)	0.7 (97)	1.2 (156)	0.6 (84)	2.5 (337)	5.4 (762)	0.1 (20)	5.5 (782)	0.8 (107)	2.3 (319)	0.5 (78)	3.6 (503)	
FEB	5.1 (687)	0.0 (4)	5.2 (691)	0.0 (0)	1.1 (143)	1.8 (244)	0.8 (112)	3.7 (499)	5.3 (746)	0.1 (15)	5.4 (761)	1.0 (144)	2.7 (381)	0.7 (96)	4.4 (621)	
MAR	4.5 (595)	0.1 (16)	4.6 (611)	0.0 (0)	0.8 (104)	2.5 (337)	1.1 (152)	4.4 (593)	4.6 (646)	0.4 (59)	5.0 (706)	0.7 (105)	3.3 (466)	1.0 (140)	5.0 (710)	
APR	1.0 (131)	0.2 (30)	1.2 (161)	0.0 (0)	0.1 (14)	1.6 (217)	1.2 (158)	2.9 (389)	1.0 (142)	0.8 (117)	1.8 (259)	0.1 (8)	1.8 (260)	1.1 (158)	3.0 (427)	
MAY	0.4 (48)	0.3 (39)	0.6 (87)	0.0 (0)	0.0 (5)	1.1 (141)	1.1 (147)	2.2 (293)	0.4 (52)	1.1 (150)	1.4 (203)	0.0 (4)	1.2 (162)	1.1 (162)	2.3 (328)	
JUN	0.2 (27)	0.3 (45)	0.5 (72)	0.0 (0)	0.0 (1)	0.7 (94)	0.9 (116)	1.6 (211)	0.2 (29)	1.3 (179)	1.5 (208)	0.0 (1)	0.8 (109)	1.2 (166)	2.0 (277)	
JUL	0.0 (1)	0.3 (45)	0.3 (47)	0.0 (0)	0.0 (0)	0.6 (74)	0.5 (71)	1.1 (145)	0.0 (2)	1.3 (183)	1.3 (185)	0.0 (0)	0.6 (84)	1.2 (165)	1.8 (249)	
AUG	0.1 (10)	0.3 (41)	0.4 (51)	0.0 (0)	0.0 (0)	0.4 (59)	0.4 (54)	0.9 (114)	0.1 (11)	1.2 (171)	1.3 (182)	0.0 (0)	0.5 (72)	1.1 (156)	1.6 (228)	
SEP	0.3 (47)	0.2 (29)	0.6 (76)	0.0 (0)	0.0 (2)	0.4 (48)	0.4 (53)	0.8 (102)	0.4 (51)	0.9 (123)	1.2 (174)	0.0 (2)	0.5 (68)	0.9 (128)	1.4 (198)	
Total	20.1 (2695)	2.1 (285)	22.3 (2979)	0.0 (0)	3.0 (397)	11.2 (1494)	8.4 (1126)	22.6 (3018)	20.7 (2925)	8.2 (1154)	28.9 (4079)	2.9 (407)	15.7 (2210)	10.6 (1496)	29.2 (4113)	

### Notes:

- (1) This includes the catchments within the Central San Juan Sub-basin that are north of San Juan Creek. Due to the grading plan of PA3, the total tributary area increases from pre to post development conditions.
- (2) The pre-development catchments include Catchments 15, 16, 20, 21, 26, 27, 28, 29, 33, and 37.
- (3) The post-development catchments include Catchments 15, 16, 20, 21, 26, 27, 28, 29, 33, 37, PA3-1, PA3-2, PA3-3, PA3-4, PA3-5, PA3-6, PA3-7, and PA3-8.



# Central San Juan (Alternative B-4) – East CSJ/PA4<sup>1</sup>

Pre-dev area = 1539 acres

Post-dev area = 1470 acres

## All Years

	Pre-Development <sup>2</sup>								Post-Development with PDFs <sup>3</sup>							
	INFLOW			OUTFLOW					INFLOW			OUTFLOW				
	Precipitation	Irrigation	Total	Quarry Runoff Recirculation	Runoff to SJ Crk	GW Outflow	ET	Total	Precipitation	Irrigation	Total	Runoff to SJ Crk	GW Outflow	ET	Total	
OCT	0.3 (40)	0.0 (2)	0.3 (42)	0.0 (0)	0.0 (1)	0.2 (27)	0.3 (34)	0.5 (62)	0.3 (38)	0.1 (10)	0.4 (48)	0.0 (2)	0.2 (24)	0.3 (40)	0.5 (66)	
NOV	1.6 (207)	0.0 (1)	1.6 (208)	0.0 (0)	0.1 (14)	0.2 (28)	0.4 (55)	0.7 (96)	1.6 (198)	0.0 (4)	1.7 (202)	0.1 (18)	0.2 (27)	0.5 (55)	0.8 (100)	
DEC	2.1 (274)	0.0 (1)	2.1 (274)	0.0 (0)	0.2 (28)	0.4 (55)	0.5 (64)	1.1 (146)	2.1 (262)	0.0 (3)	2.2 (265)	0.2 (30)	0.4 (53)	0.5 (62)	1.2 (146)	
JAN	3.6 (460)	0.0 (0)	3.6 (461)	0.0 (0)	0.5 (68)	0.9 (115)	0.6 (73)	2.0 (256)	3.6 (441)	0.0 (3)	3.6 (443)	0.5 (67)	0.9 (110)	0.6 (70)	2.0 (248)	
FEB	3.3 (425)	0.0 (0)	3.3 (426)	0.0 (0)	0.6 (80)	1.2 (160)	0.7 (95)	2.6 (334)	3.3 (407)	0.0 (2)	3.3 (409)	0.6 (79)	1.2 (152)	0.7 (89)	2.6 (320)	
MAR	2.8 (353)	0.0 (2)	2.8 (355)	0.0 (0)	0.4 (57)	1.6 (201)	1.0 (130)	3.0 (388)	2.8 (338)	0.1 (8)	2.8 (346)	0.4 (54)	1.5 (190)	1.1 (129)	3.0 (373)	
APR	1.1 (144)	0.0 (3)	1.1 (147)	0.0 (0)	0.1 (15)	1.0 (133)	1.1 (143)	2.3 (291)	1.1 (137)	0.1 (15)	1.2 (152)	0.1 (16)	1.0 (124)	1.2 (148)	2.4 (288)	
MAY	0.4 (48)	0.0 (4)	0.4 (52)	0.0 (0)	0.0 (3)	0.7 (86)	1.0 (125)	1.7 (214)	0.4 (46)	0.2 (19)	0.5 (65)	0.0 (3)	0.6 (78)	1.1 (134)	1.8 (216)	
JUN	0.1 (17)	0.0 (4)	0.2 (21)	0.0 (0)	0.0 (1)	0.4 (57)	0.5 (69)	1.0 (126)	0.1 (16)	0.2 (23)	0.3 (39)	0.0 (1)	0.4 (51)	0.7 (85)	1.1 (137)	
JUL	0.0 (4)	0.0 (4)	0.1 (8)	0.0 (0)	0.0 (0)	0.4 (45)	0.2 (25)	0.5 (70)	0.0 (4)	0.2 (23)	0.2 (27)	0.0 (0)	0.3 (40)	0.4 (45)	0.7 (85)	
AUG	0.1 (14)	0.0 (4)	0.1 (18)	0.0 (0)	0.0 (1)	0.3 (37)	0.2 (20)	0.4 (57)	0.1 (13)	0.2 (22)	0.3 (35)	0.0 (1)	0.3 (33)	0.3 (38)	0.6 (71)	
SEP	0.3 (43)	0.0 (3)	0.4 (46)	0.0 (0)	0.0 (2)	0.2 (30)	0.2 (27)	0.5 (59)	0.3 (41)	0.1 (16)	0.5 (57)	0.0 (3)	0.2 (27)	0.3 (38)	0.6 (68)	
Total	15.8 (2028)	0.2 (28)	16.0 (2056)	0.0 (0)	2.1 (268)	7.6 (972)	6.7 (859)	16.4 (2099)	15.9 (1941)	1.2 (146)	17.0 (2087)	2.2 (273)	7.4 (911)	7.6 (934)	17.3 (2118)	

## Dry Period

	Pre-Development <sup>2</sup>								Post-Development with PDFs <sup>3</sup>							
	INFLOW			OUTFLOW					INFLOW			OUTFLOW				
	Precipitation	Irrigation	Total	Quarry Runoff Recirculation	Runoff to SJ Crk	GW Outflow	ET	Total	Precipitation	Irrigation	Total	Runoff to SJ Crk	GW Outflow	ET	Total	
OCT	0.3 (40)	0.0 (2)	0.3 (42)	0.0 (0)	0.0 (1)	0.2 (23)	0.3 (37)	0.5 (61)	0.3 (38)	0.1 (10)	0.4 (48)	0.0 (2)	0.2 (21)	0.3 (43)	0.5 (65)	
NOV	1.7 (223)	0.0 (1)	1.7 (224)	0.0 (0)	0.1 (15)	0.2 (25)	0.5 (58)	0.8 (98)	1.7 (214)	0.0 (4)	1.8 (218)	0.2 (19)	0.2 (25)	0.5 (58)	0.8 (102)	
DEC	2.3 (290)	0.0 (1)	2.3 (291)	0.0 (0)	0.2 (30)	0.4 (53)	0.5 (67)	1.2 (149)	2.3 (278)	0.0 (3)	2.3 (281)	0.3 (33)	0.4 (51)	0.5 (65)	1.2 (148)	
JAN	2.7 (342)	0.0 (0)	2.7 (343)	0.0 (0)	0.3 (42)	0.7 (85)	0.6 (72)	1.6 (199)	2.7 (328)	0.0 (3)	2.7 (330)	0.4 (43)	0.7 (81)	0.6 (70)	1.6 (194)	
FEB	2.3 (298)	0.0 (0)	2.3 (298)	0.0 (0)	0.3 (43)	0.9 (109)	0.7 (93)	1.9 (245)	2.3 (285)	0.0 (2)	2.3 (287)	0.3 (42)	0.8 (103)	0.7 (88)	1.9 (233)	
MAR	1.8 (236)	0.0 (2)	1.8 (237)	0.0 (0)	0.2 (28)	1.0 (127)	1.0 (128)	2.2 (283)	1.8 (226)	0.1 (8)	1.9 (233)	0.2 (27)	1.0 (119)	1.0 (128)	2.2 (274)	
APR	1.2 (149)	0.0 (3)	1.2 (152)	0.0 (0)	0.1 (15)	0.8 (97)	1.1 (145)	2.0 (256)	1.2 (142)	0.1 (15)	1.3 (157)	0.1 (16)	0.7 (89)	1.2 (150)	2.1 (255)	
MAY	0.4 (47)	0.0 (4)	0.4 (51)	0.0 (0)	0.0 (2)	0.5 (64)	1.0 (129)	1.5 (196)	0.4 (45)	0.2 (19)	0.5 (64)	0.0 (3)	0.5 (58)	1.1 (139)	1.6 (199)	
JUN	0.1 (12)	0.0 (4)	0.1 (17)	0.0 (0)	0.0 (0)	0.3 (44)	0.5 (69)	0.9 (114)	0.1 (12)	0.2 (23)	0.3 (34)	0.0 (0)	0.3 (39)	0.7 (86)	1.0 (125)	
JUL	0.0 (5)	0.0 (4)	0.1 (10)	0.0 (0)	0.0 (0)	0.3 (36)	0.2 (27)	0.5 (63)	0.0 (5)	0.2 (23)	0.2 (28)	0.0 (0)	0.3 (31)	0.4 (47)	0.6 (78)	
AUG	0.1 (16)	0.0 (4)	0.2 (20)	0.0 (0)	0.0 (1)	0.2 (30)	0.2 (20)	0.4 (51)	0.1 (15)	0.2 (22)	0.3 (37)	0.0 (1)	0.2 (26)	0.3 (38)	0.5 (65)	
SEP	0.3 (40)	0.0 (3)	0.3 (43)	0.0 (0)	0.0 (2)	0.2 (25)	0.2 (28)	0.4 (54)	0.3 (39)	0.1 (16)	0.4 (54)	0.0 (3)	0.2 (22)	0.3 (39)	0.5 (63)	
Total	13.3 (1699)	0.2 (28)	13.5 (1727)	0.0 (0)	1.4 (178)	5.6 (718)	6.8 (873)	13.8 (1769)	13.3 (1626)	1.2 (146)	14.5 (1772)	1.5 (188)	5.4 (666)	7.7 (948)	14.7 (1803)	

## Wet Period

	Pre-Development <sup>2</sup>								Post-Development with PDFs <sup>3</sup>							
	INFLOW			OUTFLOW					INFLOW			OUTFLOW				
	Precipitation	Irrigation	Total	Quarry Runoff Recirculation	Runoff to SJ Crk	GW Outflow	ET	Total	Precipitation	Irrigation	Total	Runoff to SJ Crk	GW Outflow	ET	Total	
OCT	0.3 (40)	0.0 (2)	0.3 (42)	0.0 (0)	0.0 (1)	0.3 (34)	0.2 (28)	0.5 (63)	0.3 (38)	0.1 (10)	0.4 (48)	0.0 (2)	0.3 (32)	0.3 (35)	0.6 (68)	
NOV	1.3 (173)	0.0 (1)	1.4 (173)	0.0 (0)	0.1 (11)	0.2 (32)	0.4 (48)	0.7 (91)	1.4 (165)	0.0 (4)	1.4 (170)	0.1 (15)	0.3 (31)	0.4 (49)	0.8 (96)	
DEC	1.9 (239)	0.0 (1)	1.9 (240)	0.0 (0)	0.2 (23)	0.5 (59)	0.4 (57)	1.1 (140)	1.9 (229)	0.0 (3)	1.9 (232)	0.2 (25)	0.5 (58)	0.5 (57)	1.1 (139)	
JAN	5.5 (710)	0.0 (0)	5.5 (710)	0.0 (0)	1.0 (124)	1.4 (177)	0.6 (75)	2.9 (376)	5.5 (679)	0.0 (3)	5.6 (682)	1.0 (117)	1.4 (172)	0.6 (72)	3.0 (362)	
FEB	5.4 (694)	0.0 (0)	5.4 (695)	0.0 (0)	1.2 (158)	2.1 (266)	0.8 (99)	4.1 (523)	5.4 (665)	0.0 (2)	5.4 (667)	1.3 (157)	2.1 (254)	0.8 (93)	4.1 (504)	
MAR	4.7 (602)	0.0 (2)	4.7 (603)	0.0 (0)	0.9 (119)	2.8 (357)	1.0 (134)	4.8 (610)	4.7 (576)	0.1 (8)	4.8 (584)	0.9 (112)	2.8 (339)	1.1 (132)	4.8 (583)	
APR	1.0 (132)	0.0 (3)	1.1 (135)	0.0 (0)	0.1 (15)	1.7 (212)	1.1 (139)	2.9 (366)	1.0 (127)	0.1 (15)	1.2 (142)	0.1 (15)	1.6 (198)	1.2 (145)	2.9 (358)	
MAY	0.4 (49)	0.0 (4)	0.4 (53)	0.0 (0)	0.0 (5)	1.0 (131)	0.9 (116)	2.0 (252)	0.4 (47)	0.2 (19)	0.5 (66)	0.0 (5)	1.0 (122)	1.0 (125)	2.1 (251)	
JUN	0.2 (27)	0.0 (4)	0.2 (32)	0.0 (0)	0.0 (1)	0.7 (84)	0.5 (68)	1.2 (152)	0.2 (26)	0.2 (23)	0.4 (49)	0.0 (1)	0.6 (77)	0.7 (82)	1.3 (161)	
JUL	0.0 (1)	0.0 (4)	0.0 (6)	0.0 (0)	0.0 (0)	0.5 (65)	0.2 (21)	0.7 (86)	0.0 (1)	0.2 (23)	0.2 (25)	0.0 (0)	0.5 (60)	0.3 (41)	0.8 (100)	
AUG	0.1 (10)	0.0 (4)	0.1 (14)	0.0 (0)	0.0 (0)	0.4 (52)	0.1 (18)	0.5 (70)	0.1 (10)	0.2 (22)	0.3 (31)	0.0 (0)	0.4 (48)	0.3 (37)	0.7 (85)	
SEP	0.4 (47)	0.0 (3)	0.4 (50)	0.0 (0)	0.0 (1)	0.3 (42)	0.2 (26)	0.5 (69)	0.4 (45)	0.1 (16)	0.5 (61)	0.0 (3)	0.3 (39)	0.3 (37)	0.6 (78)	
Total	21.3 (2725)	0.2 (28)	21.5 (2753)	0.0 (0)	3.6 (459)	11.8 (1509)	6.5 (829)	21.8 (2798)	21.3 (2609)	1.2 (146)	22.5 (2755)	3.7 (452)	11.7 (1429)	7.4 (904)	22.7 (2785)	

### Notes:

- (1) This includes the catchments within the Central San Juan Sub-basin that are primarily southeast of San Juan Creek. Due to the grading plan of PA4 and PA3, the total tributary area decreases from pre to post development conditions.
- (2) The pre-development catchments include Catchments 24, 30, 31, 32, 34, 35, 36, and 38.
- (3) The post-development catchments include Catchments 24, 30, 31, 32, 34, 35, 36, and 38.

# Central San Juan (Alternative B9) - Total Sub-basin<sup>1</sup>

Pre-dev area = 4810 acres

Post-dev area = 4857 acres

## All Years

	Pre-Development								Post-Development with PDFs						
	INFLOW			OUTFLOW					INFLOW			OUTFLOW			
	Precipitation	Irrigation	Total	Quarry Runoff Recirculation	Runoff to SJ Crk	GW flows	ET	Total	Precipitation	Irrigation	Total	Runoff to SJ Crk	GW flows	ET	Total
OCT	0.3 (124)	0.0 (19)	0.4 (143)	0.0 (1)	0.0 (3)	0.2 (83)	0.3 (130)	0.5 (217)	0.3 (127)	0.6 (246)	0.9 (373)	0.0 (3)	0.5 (204)	0.7 (278)	1.2 (486)
NOV	1.6 (643)	0.0 (9)	1.6 (652)	0.2 (8)	0.1 (29)	0.2 (80)	0.5 (191)	0.8 (307)	1.6 (658)	0.3 (104)	1.9 (762)	0.1 (41)	0.8 (306)	0.6 (240)	1.5 (587)
DEC	2.1 (850)	0.0 (6)	2.1 (856)	0.3 (10)	0.2 (59)	0.4 (146)	0.5 (216)	1.1 (431)	2.1 (869)	0.2 (77)	2.3 (946)	0.2 (71)	1.1 (431)	0.5 (217)	1.8 (719)
JAN	3.6 (1429)	0.0 (5)	3.6 (1435)	0.5 (18)	0.4 (149)	0.8 (317)	0.6 (245)	1.8 (730)	3.6 (1461)	0.2 (63)	3.8 (1525)	0.4 (163)	1.7 (678)	0.6 (234)	2.7 (1075)
FEB	3.3 (1321)	0.0 (4)	3.3 (1325)	0.6 (21)	0.5 (190)	1.2 (469)	0.8 (315)	2.5 (995)	3.3 (1350)	0.1 (48)	3.5 (1398)	0.5 (185)	1.8 (746)	0.7 (286)	3.0 (1217)
MAR	2.7 (1097)	0.0 (17)	2.8 (1114)	0.4 (13)	0.4 (131)	1.5 (610)	1.1 (445)	3.0 (1199)	2.8 (1121)	0.5 (191)	3.2 (1313)	0.3 (120)	2.1 (846)	1.1 (428)	3.4 (1394)
APR	1.1 (446)	0.1 (33)	1.2 (479)	0.1 (5)	0.1 (34)	1.0 (418)	1.3 (515)	2.4 (972)	1.1 (456)	0.9 (365)	2.0 (821)	0.1 (23)	1.4 (569)	1.3 (509)	2.7 (1101)
MAY	0.4 (149)	0.1 (42)	0.5 (191)	0.0 (2)	0.0 (7)	0.7 (273)	1.1 (458)	1.8 (740)	0.4 (152)	1.2 (471)	1.5 (623)	0.0 (6)	1.0 (400)	1.2 (498)	2.2 (903)
JUN	0.1 (53)	0.1 (49)	0.3 (102)	0.0 (1)	0.0 (1)	0.5 (185)	0.6 (258)	1.1 (444)	0.1 (54)	1.4 (564)	1.5 (618)	0.0 (1)	0.8 (316)	1.1 (446)	1.9 (764)
JUL	0.0 (12)	0.1 (50)	0.2 (62)	0.0 (0)	0.0 (0)	0.4 (146)	0.3 (110)	0.6 (257)	0.0 (13)	1.4 (580)	1.5 (592)	0.0 (0)	0.7 (285)	1.0 (420)	1.7 (705)
AUG	0.1 (43)	0.1 (45)	0.2 (88)	0.0 (0)	0.0 (1)	0.3 (118)	0.2 (89)	0.5 (209)	0.1 (44)	1.3 (541)	1.4 (585)	0.0 (2)	0.7 (266)	1.0 (400)	1.6 (667)
SEP	0.3 (132)	0.1 (32)	0.4 (165)	0.0 (2)	0.0 (4)	0.2 (95)	0.3 (111)	0.5 (212)	0.3 (135)	1.0 (392)	1.3 (527)	0.0 (6)	0.6 (241)	0.8 (344)	1.5 (590)
<b>Total</b>	<b>15.7 (6299)</b>	<b>0.8 (312)</b>	<b>16.5 (6612)</b>	<b>2.3 (81)</b>	<b>1.7 (608)</b>	<b>7.3 (2941)</b>	<b>7.7 (3082)</b>	<b>16.7 (6713)</b>	<b>15.9 (6439)</b>	<b>9.0 (3642)</b>	<b>24.9 (10081)</b>	<b>1.5 (623)</b>	<b>13.1 (5289)</b>	<b>10.6 (4299)</b>	<b>25.2 (10210)</b>

## Dry Period

	Pre-Development								Post-Development with PDFs						
	INFLOW			OUTFLOW					INFLOW			OUTFLOW			
	Precipitation	Irrigation	Total	Quarry Runoff Recirculation	Runoff to SJ Crk	GW flows	ET	Total	Precipitation	Irrigation	Total	Runoff to SJ Crk	GW flows	ET	Total
OCT	0.3 (124)	0.0 (19)	0.4 (144)	0.0 (1)	0.0 (3)	0.2 (72)	0.3 (140)	0.5 (217)	0.3 (127)	0.6 (246)	0.9 (373)	0.0 (3)	0.5 (197)	0.7 (283)	1.2 (484)
NOV	1.7 (694)	0.0 (8)	1.8 (702)	0.2 (8)	0.1 (31)	0.2 (73)	0.5 (201)	0.8 (314)	1.8 (710)	0.3 (103)	2.0 (813)	0.1 (46)	0.8 (315)	0.6 (244)	1.5 (605)
DEC	2.2 (901)	0.0 (6)	2.3 (907)	0.3 (11)	0.2 (63)	0.3 (139)	0.6 (224)	1.1 (437)	2.3 (921)	0.2 (76)	2.5 (998)	0.2 (77)	1.1 (440)	0.5 (221)	1.8 (738)
JAN	2.7 (1063)	0.0 (5)	2.7 (1069)	0.4 (13)	0.2 (87)	0.6 (226)	0.6 (243)	1.4 (569)	2.7 (1088)	0.2 (63)	2.8 (1151)	0.2 (100)	1.3 (543)	0.6 (229)	2.2 (872)
FEB	2.3 (925)	0.0 (4)	2.3 (930)	0.4 (13)	0.3 (98)	0.8 (310)	0.8 (309)	1.8 (730)	2.3 (946)	0.1 (48)	2.5 (995)	0.2 (91)	1.4 (578)	0.7 (280)	2.3 (919)
MAR	1.8 (732)	0.0 (18)	1.9 (749)	0.2 (9)	0.2 (63)	0.9 (373)	1.1 (441)	2.2 (886)	1.8 (748)	0.5 (193)	2.3 (941)	0.1 (45)	1.4 (578)	1.0 (422)	2.6 (1045)
APR	1.2 (462)	0.1 (33)	1.2 (495)	0.2 (5)	0.1 (33)	0.7 (290)	1.3 (518)	2.1 (847)	1.2 (473)	0.9 (363)	2.1 (835)	0.1 (24)	1.1 (465)	1.3 (509)	2.5 (998)
MAY	0.4 (147)	0.1 (42)	0.5 (189)	0.0 (2)	0.0 (5)	0.5 (199)	1.2 (475)	1.7 (681)	0.4 (150)	1.2 (469)	1.5 (619)	0.0 (4)	0.8 (339)	1.2 (506)	2.1 (848)
JUN	0.1 (38)	0.1 (49)	0.2 (87)	0.0 (0)	0.0 (1)	0.4 (140)	0.7 (263)	1.0 (405)	0.1 (39)	1.4 (564)	1.5 (603)	0.0 (1)	0.7 (277)	1.1 (446)	1.8 (724)
JUL	0.0 (16)	0.1 (50)	0.2 (65)	0.0 (0)	0.0 (0)	0.3 (114)	0.3 (117)	0.6 (231)	0.0 (16)	1.4 (579)	1.5 (596)	0.0 (0)	0.6 (260)	1.0 (421)	1.7 (682)
AUG	0.1 (48)	0.1 (45)	0.2 (94)	0.0 (1)	0.0 (2)	0.2 (94)	0.2 (91)	0.5 (187)	0.1 (49)	1.3 (541)	1.5 (590)	0.0 (2)	0.6 (249)	1.0 (401)	1.6 (652)
SEP	0.3 (126)	0.1 (32)	0.4 (158)	0.0 (1)	0.0 (4)	0.2 (78)	0.3 (113)	0.5 (196)	0.3 (128)	1.0 (393)	1.3 (521)	0.0 (6)	0.6 (227)	0.9 (345)	1.4 (579)
<b>Total</b>	<b>13.2 (5277)</b>	<b>0.8 (312)</b>	<b>13.9 (5589)</b>	<b>1.8 (64)</b>	<b>1.1 (391)</b>	<b>5.3 (2109)</b>	<b>7.8 (3136)</b>	<b>14.2 (5700)</b>	<b>13.3 (5396)</b>	<b>9.0 (3638)</b>	<b>22.3 (9034)</b>	<b>1.0 (400)</b>	<b>11.0 (4439)</b>	<b>10.6 (4307)</b>	<b>22.6 (9145)</b>

## Wet Period

	Pre-Development								Post-Development with PDFs						
	INFLOW			OUTFLOW					INFLOW			OUTFLOW			
	Precipitation	Irrigation	Total	Quarry Runoff Recirculation	Runoff to SJ Crk	GW Outflow	ET	Total	Precipitation	Irrigation	Total	Runoff to SJ Crk	GW Outflow	ET	Total
OCT	0.3 (124)	0.0 (19)	0.4 (143)	0.0 (1)	0.0 (3)	0.3 (107)	0.3 (108)	0.5 (219)	0.3 (127)	0.4 (159)	0.7 (286)	0.0 (4)	0.4 (148)	0.6 (229)	0.9 (381)
NOV	1.3 (536)	0.0 (9)	1.4 (545)	0.2 (6)	0.1 (24)	0.2 (95)	0.4 (169)	0.7 (293)	1.3 (552)	0.2 (68)	1.5 (620)	0.1 (33)	0.5 (215)	0.5 (211)	1.1 (458)
DEC	1.9 (742)	0.0 (6)	1.9 (748)	0.3 (9)	0.1 (51)	0.4 (161)	0.5 (199)	1.0 (419)	1.9 (764)	0.1 (50)	2.0 (814)	0.1 (58)	0.8 (342)	0.5 (199)	1.5 (599)
JAN	5.5 (2204)	0.0 (5)	5.5 (2210)	0.9 (30)	0.8 (279)	1.3 (510)	0.6 (250)	2.7 (1070)	5.5 (2270)	0.1 (41)	5.6 (2310)	0.7 (286)	2.1 (871)	0.6 (234)	3.4 (1391)
FEB	5.4 (2157)	0.0 (4)	5.4 (2162)	1.1 (38)	1.1 (385)	2.0 (807)	0.8 (327)	3.9 (1557)	5.4 (2222)	0.1 (31)	5.5 (2252)	0.9 (382)	2.7 (1103)	0.7 (289)	4.3 (1774)
MAR	4.7 (1870)	0.0 (17)	4.7 (1887)	0.6 (22)	0.8 (275)	2.8 (1110)	1.1 (453)	4.6 (1861)	4.7 (1926)	0.3 (121)	5.0 (2046)	0.7 (277)	3.3 (1368)	1.0 (420)	5.0 (2065)
APR	1.0 (411)	0.1 (33)	1.1 (445)	0.1 (5)	0.1 (34)	1.7 (687)	1.3 (510)	3.1 (1235)	1.0 (423)	0.6 (237)	1.6 (660)	0.1 (28)	1.8 (743)	1.2 (483)	3.1 (1254)
MAY	0.4 (152)	0.1 (42)	0.5 (194)	0.0 (2)	0.0 (11)	1.1 (431)	1.1 (423)	2.2 (867)	0.4 (156)	0.7 (305)	1.1 (461)	0.0 (11)	1.1 (458)	1.1 (462)	2.3 (931)
JUN	0.2 (84)	0.1 (49)	0.3 (134)	0.0 (1)	0.0 (2)	0.7 (279)	0.6 (246)	1.3 (527)	0.2 (87)	0.9 (363)	1.1 (450)	0.0 (3)	0.7 (300)	1.0 (409)	1.7 (712)
JUL	0.0 (5)	0.1 (50)	0.1 (54)	0.0 (0)	0.0 (0)	0.5 (214)	0.2 (97)	0.8 (311)	0.0 (5)	0.9 (373)	0.9 (377)	0.0 (0)	0.6 (229)	0.9 (353)	1.4 (582)
AUG	0.1 (32)	0.1 (45)	0.2 (77)	0.0 (0)	0.0 (1)	0.4 (168)	0.2 (84)	0.6 (253)	0.1 (33)	0.8 (347)	0.9 (380)	0.0 (1)	0.5 (190)	0.8 (333)	1.3 (524)
SEP	0.4 (147)	0.1 (32)	0.4 (179)	0.0 (2)	0.0 (4)	0.3 (133)	0.3 (107)	0.6 (245)	0.4 (151)	0.6 (251)	1.0 (402)	0.0 (6)	0.4 (173)	0.7 (285)	1.1 (464)
<b>Total</b>	<b>21.1 (8465)</b>	<b>0.8 (313)</b>	<b>21.9 (8778)</b>	<b>3.3 (116)</b>	<b>2.9 (1068)</b>	<b>11.7 (4703)</b>	<b>7.4 (2969)</b>	<b>22.1 (8858)</b>	<b>21.3 (8716)</b>	<b>5.7 (2344)</b>	<b>27.0 (11059)</b>	<b>2.7 (1086)</b>	<b>15.0 (6140)</b>	<b>9.5 (3908)</b>	<b>27.2 (11134)</b>

### Notes:

(1) This includes the catchments within the Central San Juan Sub-basin. Due to the grading plans of PA3, PA4, and PA5, the total tributary area increases from pre to post development conditions.

# Central San Juan (Alternative B-9) – East CSJ/PA4<sup>1</sup>

Pre-dev area = 1539 acres

Post-dev area = 1427 acres

## All Years

	Pre-Development <sup>2</sup>								Post-Development with PDFs <sup>3</sup>							
	INFLOW			OUTFLOW					INFLOW			OUTFLOW				
	Precipitation	Irrigation	Total	Quarry Runoff Recirculation	Runoff to SJ Crk	GW flows	ET	Total	Precipitation	Irrigation	Total	Runoff to SJ Crk	GW flows	ET	Total	
OCT	0.3 (40)	0.0 (2)	0.3 (42)	0.0 (0)	0.0 (1)	0.2 (27)	0.3 (34)	0.5 (62)	0.3 (38)	0.8 (99)	1.2 (137)	0.0 (2)	0.8 (99)	0.7 (80)	1.5 (181)	
NOV	1.6 (207)	0.0 (1)	1.6 (208)	0.0 (0)	0.1 (14)	0.2 (28)	0.4 (55)	0.7 (96)	1.6 (195)	0.4 (42)	2.0 (237)	0.2 (20)	0.9 (107)	0.6 (75)	1.7 (202)	
DEC	2.1 (274)	0.0 (1)	2.1 (274)	0.0 (0)	0.2 (28)	0.4 (55)	0.5 (64)	1.1 (146)	2.2 (258)	0.3 (31)	2.4 (289)	0.3 (33)	1.1 (132)	0.6 (72)	2.0 (238)	
JAN	3.6 (460)	0.0 (0)	3.6 (461)	0.0 (0)	0.5 (68)	0.9 (115)	0.6 (73)	2.0 (256)	3.6 (434)	0.2 (26)	3.9 (460)	0.6 (73)	1.6 (190)	0.7 (79)	2.9 (342)	
FEB	3.3 (425)	0.0 (0)	3.3 (426)	0.0 (0)	0.6 (80)	1.2 (160)	0.7 (95)	2.6 (334)	3.4 (401)	0.2 (19)	3.5 (420)	0.7 (80)	1.7 (204)	0.8 (99)	3.2 (384)	
MAR	2.8 (353)	0.0 (2)	2.8 (355)	0.0 (0)	0.4 (57)	1.6 (201)	1.0 (130)	3.0 (388)	2.8 (333)	0.6 (77)	3.4 (410)	0.4 (52)	2.0 (237)	1.2 (148)	3.7 (437)	
APR	1.1 (144)	0.0 (3)	1.1 (147)	0.0 (0)	0.1 (15)	1.0 (133)	1.1 (143)	2.3 (291)	1.1 (135)	1.2 (147)	2.4 (283)	0.1 (11)	1.6 (187)	1.5 (173)	3.1 (372)	
MAY	0.4 (48)	0.0 (4)	0.4 (52)	0.0 (0)	0.0 (3)	0.7 (86)	1.0 (125)	1.7 (214)	0.4 (45)	1.6 (190)	2.0 (235)	0.0 (3)	1.4 (161)	1.3 (153)	2.7 (316)	
JUN	0.1 (17)	0.0 (4)	0.2 (21)	0.0 (0)	0.0 (1)	0.4 (57)	0.5 (69)	1.0 (126)	0.1 (16)	1.9 (228)	2.0 (244)	0.0 (1)	1.3 (155)	1.0 (122)	2.3 (278)	
JUL	0.0 (4)	0.0 (4)	0.1 (8)	0.0 (0)	0.0 (0)	0.4 (45)	0.2 (25)	0.5 (70)	0.0 (4)	2.0 (234)	2.0 (238)	0.0 (0)	1.3 (156)	0.9 (108)	2.2 (264)	
AUG	0.1 (14)	0.0 (4)	0.1 (18)	0.0 (0)	0.0 (1)	0.3 (37)	0.2 (20)	0.4 (57)	0.1 (13)	1.8 (218)	1.9 (231)	0.0 (1)	1.3 (150)	0.9 (104)	2.1 (255)	
SEP	0.3 (43)	0.0 (3)	0.4 (46)	0.0 (0)	0.0 (2)	0.2 (30)	0.2 (27)	0.5 (59)	0.3 (40)	1.3 (158)	1.7 (198)	0.0 (3)	1.1 (127)	0.8 (96)	1.9 (226)	
Total	15.8 (2028)	0.2 (28)	16.0 (2056)	0.0 (0)	2.1 (268)	7.6 (972)	6.7 (859)	16.4 (2099)	16.1 (1913)	12.4 (1469)	28.4 (3382)	2.3 (279)	16.0 (1905)	11.0 (1311)	29.4 (3495)	

## Dry Period

	Pre-Development <sup>2</sup>								Post-Development with PDFs <sup>3</sup>							
	INFLOW			OUTFLOW					INFLOW			OUTFLOW				
	Precipitation	Irrigation	Total	Quarry Runoff Recirculation	Runoff to SJ Crk	GW flows	ET	Total	Precipitation	Irrigation	Total	Runoff to SJ Crk	GW flows	ET	Total	
OCT	0.3 (40)	0.0 (2)	0.3 (42)	0.0 (0)	0.0 (1)	0.2 (23)	0.3 (37)	0.5 (61)	0.3 (38)	0.8 (99)	1.1 (137)	0.0 (2)	0.8 (97)	0.7 (82)	1.5 (181)	
NOV	1.7 (223)	0.0 (1)	1.7 (224)	0.0 (0)	0.1 (15)	0.2 (25)	0.5 (58)	0.8 (98)	1.8 (211)	0.4 (42)	2.1 (252)	0.2 (22)	0.9 (109)	0.6 (77)	1.8 (208)	
DEC	2.3 (290)	0.0 (1)	2.3 (291)	0.0 (0)	0.2 (30)	0.4 (53)	0.5 (67)	1.2 (149)	2.3 (274)	0.3 (31)	2.6 (304)	0.3 (36)	1.1 (134)	0.6 (74)	2.1 (244)	
JAN	2.7 (342)	0.0 (0)	2.7 (343)	0.0 (0)	0.3 (42)	0.7 (85)	0.6 (72)	1.6 (199)	2.7 (323)	0.2 (26)	2.9 (348)	0.4 (46)	1.3 (154)	0.7 (77)	2.3 (277)	
FEB	2.3 (298)	0.0 (0)	2.3 (298)	0.0 (0)	0.3 (43)	0.9 (109)	0.7 (93)	1.9 (245)	2.4 (281)	0.2 (19)	2.5 (300)	0.3 (41)	1.3 (151)	0.8 (97)	2.4 (290)	
MAR	1.8 (236)	0.0 (2)	1.8 (237)	0.0 (0)	0.2 (28)	1.0 (127)	1.0 (128)	2.2 (283)	1.9 (222)	0.7 (78)	2.5 (300)	0.2 (21)	1.4 (165)	1.2 (146)	2.8 (332)	
APR	1.2 (149)	0.0 (3)	1.2 (152)	0.0 (0)	0.1 (15)	0.8 (97)	1.1 (145)	2.0 (256)	1.2 (140)	1.2 (146)	2.4 (287)	0.1 (2)	1.3 (159)	1.5 (174)	2.9 (345)	
MAY	0.4 (47)	0.0 (4)	0.4 (51)	0.0 (0)	0.0 (2)	0.5 (64)	1.0 (129)	1.5 (196)	0.4 (45)	1.6 (189)	2.0 (234)	0.0 (2)	1.2 (145)	1.3 (157)	2.6 (304)	
JUN	0.1 (12)	0.0 (4)	0.1 (17)	0.0 (0)	0.0 (0)	0.3 (44)	0.5 (69)	0.9 (114)	0.1 (12)	1.9 (227)	2.0 (239)	0.0 (0)	1.2 (144)	1.0 (122)	2.2 (267)	
JUL	0.0 (5)	0.0 (4)	0.1 (10)	0.0 (0)	0.0 (0)	0.3 (36)	0.2 (27)	0.5 (63)	0.0 (5)	2.0 (234)	2.0 (239)	0.0 (0)	1.2 (149)	0.9 (109)	2.2 (258)	
AUG	0.1 (16)	0.0 (4)	0.2 (20)	0.0 (0)	0.0 (1)	0.2 (30)	0.2 (20)	0.4 (51)	0.1 (15)	1.8 (218)	2.0 (233)	0.0 (1)	1.2 (145)	0.9 (105)	2.1 (251)	
SEP	0.3 (40)	0.0 (3)	0.3 (43)	0.0 (0)	0.0 (2)	0.2 (25)	0.2 (28)	0.4 (54)	0.3 (38)	1.3 (158)	1.7 (197)	0.0 (3)	1.0 (123)	0.8 (96)	1.9 (222)	
Total	13.3 (1699)	0.2 (28)	13.5 (1727)	0.0 (0)	1.4 (178)	5.6 (718)	6.8 (873)	13.8 (1769)	13.5 (1602)	12.3 (1468)	25.8 (3070)	1.6 (186)	14.1 (1676)	11.1 (1317)	26.7 (3179)	

## Wet Period

	Pre-Development <sup>2</sup>								Post-Development with PDFs <sup>3</sup>							
	INFLOW			OUTFLOW					INFLOW			OUTFLOW				
	Precipitation	Irrigation	Total	Quarry Runoff Recirculation	Runoff to SJ Crk	GW flows	ET	Total	Precipitation	Irrigation	Total	Runoff to SJ Crk	GW flows	ET	Total	
OCT	0.3 (40)	0.0 (2)	0.3 (42)	0.0 (0)	0.0 (1)	0.3 (34)	0.2 (28)	0.5 (63)	0.3 (38)	0.8 (100)	1.2 (137)	0.0 (2)	0.9 (103)	0.6 (76)	1.5 (180)	
NOV	1.3 (173)	0.0 (1)	1.4 (173)	0.0 (0)	0.1 (11)	0.2 (32)	0.4 (48)	0.7 (91)	1.4 (163)	0.4 (42)	1.7 (205)	0.1 (16)	0.9 (103)	0.6 (71)	1.6 (189)	
DEC	1.9 (239)	0.0 (1)	1.9 (240)	0.0 (0)	0.2 (23)	0.5 (59)	0.4 (57)	1.1 (140)	1.9 (225)	0.3 (31)	2.2 (257)	0.2 (27)	1.1 (128)	0.6 (68)	1.9 (223)	
JAN	5.5 (710)	0.0 (0)	5.5 (710)	0.0 (0)	1.0 (124)	1.4 (177)	0.6 (75)	2.9 (376)	5.6 (669)	0.2 (26)	5.8 (695)	1.1 (131)	2.3 (268)	0.7 (81)	4.0 (480)	
FEB	5.4 (694)	0.0 (0)	5.4 (695)	0.0 (0)	1.2 (158)	2.1 (266)	0.8 (99)	4.1 (523)	5.5 (655)	0.2 (19)	5.7 (674)	1.4 (163)	2.7 (317)	0.9 (103)	4.9 (584)	
MAR	4.7 (602)	0.0 (2)	4.7 (603)	0.0 (0)	0.9 (119)	2.8 (357)	1.0 (134)	4.8 (610)	4.8 (568)	0.6 (76)	5.4 (643)	1.0 (119)	3.3 (389)	1.3 (153)	5.6 (660)	
APR	1.0 (132)	0.0 (3)	1.1 (135)	0.0 (0)	0.1 (15)	1.7 (212)	1.1 (139)	2.9 (366)	1.0 (125)	1.3 (149)	2.3 (274)	0.1 (11)	2.1 (246)	1.4 (171)	3.6 (428)	
MAY	0.4 (49)	0.0 (4)	0.4 (53)	0.0 (0)	0.0 (5)	1.0 (131)	0.9 (116)	2.0 (252)	0.4 (46)	1.6 (192)	2.0 (238)	0.0 (4)	1.6 (194)	1.2 (146)	2.9 (344)	
JUN	0.2 (27)	0.0 (4)	0.2 (32)	0.0 (0)	0.0 (1)	0.7 (84)	0.5 (68)	1.2 (152)	0.2 (26)	1.9 (228)	2.1 (253)	0.0 (1)	1.5 (177)	1.0 (123)	2.5 (301)	
JUL	0.0 (1)	0.0 (4)	0.0 (6)	0.0 (0)	0.0 (0)	0.5 (65)	0.2 (21)	0.7 (86)	0.0 (1)	2.0 (234)	2.0 (235)	0.0 (0)	1.4 (171)	0.9 (107)	2.3 (278)	
AUG	0.1 (10)	0.0 (4)	0.1 (14)	0.0 (0)	0.0 (0)	0.4 (52)	0.1 (18)	0.5 (70)	0.1 (10)	1.8 (218)	1.9 (228)	0.0 (0)	1.3 (160)	0.9 (103)	2.2 (264)	
SEP	0.4 (47)	0.0 (3)	0.4 (50)	0.0 (0)	0.0 (1)	0.3 (42)	0.2 (26)	0.5 (69)	0.4 (45)	1.3 (157)	1.7 (202)	0.0 (3)	1.1 (135)	0.8 (94)	2.0 (233)	
Total	21.3 (2725)	0.2 (28)	21.5 (2753)	0.0 (0)	3.6 (459)	11.8 (1509)	6.5 (829)	21.8 (2798)	21.6 (2570)	12.4 (1473)	34.0 (4042)	4.0 (476)	20.1 (2390)	10.9 (1297)	35.0 (4163)	

### Notes:

- (1) This includes the catchments within the Central San Juan Sub-basin that are primarily southeast of San Juan Creek. Due to the grading plan of PA4 and PA3, the total tributary area decreases from pre to post development conditions.
- (2) The pre-development catchments include Catchments 24, 30, 31, 32, 34, 35, 36, and 38.
- (3) The post-development catchments include Catchments 24, 30, 31, 32, 34, 35, 36, and 38.

## Cristianitos (Alternative B-4) - Total Sub-basin

Pre-dev area = 2370 acres

Post-dev area = 2191 acres

### All Years

	Pre-Development					Post-Development with PDFs								
	INFLOW	OUIFLOW				INFLOW			OUIFLOW					
	Precipitation	Runoff to Cristianitos Crk	GW Outflow	ET	Total	Precipitation	Irrigation	Total	Runoff to Cristianitos Crk	Stored Runoff for GC Irrig	Runoff Diverted to Gabino	GW Outflow	ET	Total
OCT	0.3 (58)	0.0 (1)	0.0 (4)	0.3 (59)	0.3 (64)	0.3 (53)	0.2 (43)	0.5 (96)	0.0 (0)	0.0 (1)	0.0 (2)	0.0 (7)	0.6 (105)	0.6 (115)
NOV	1.5 (299)	0.0 (7)	0.0 (5)	0.6 (112)	0.6 (124)	1.5 (274)	0.1 (19)	1.6 (293)	0.0 (5)	0.0 (4)	0.1 (13)	0.1 (11)	0.7 (131)	0.9 (164)
DEC	2.0 (394)	0.1 (10)	0.1 (20)	0.6 (128)	0.8 (158)	2.0 (362)	0.1 (13)	2.1 (376)	0.1 (9)	0.0 (4)	0.1 (17)	0.2 (35)	0.7 (135)	1.1 (201)
JAN	3.4 (663)	0.1 (22)	0.6 (123)	0.8 (153)	1.5 (298)	3.3 (609)	0.1 (11)	3.4 (620)	0.1 (25)	0.0 (6)	0.1 (27)	0.7 (130)	0.9 (157)	1.9 (344)
FEB	3.1 (613)	0.1 (20)	1.1 (224)	1.0 (197)	2.2 (441)	3.1 (563)	0.1 (9)	3.1 (572)	0.1 (23)	0.0 (5)	0.1 (25)	1.1 (202)	1.1 (199)	2.5 (454)
MAR	2.6 (509)	0.1 (13)	1.2 (230)	1.5 (291)	2.7 (534)	2.6 (468)	0.2 (37)	2.8 (504)	0.1 (14)	0.1 (10)	0.1 (22)	1.1 (205)	1.6 (295)	3.0 (545)
APR	1.0 (207)	0.0 (3)	0.5 (89)	1.8 (360)	2.3 (452)	1.0 (190)	0.4 (69)	1.4 (259)	0.0 (2)	0.0 (7)	0.0 (8)	0.5 (83)	2.0 (365)	2.5 (465)
MAY	0.3 (69)	0.0 (1)	0.2 (31)	1.8 (355)	2.0 (387)	0.3 (63)	0.5 (89)	0.8 (152)	0.0 (0)	0.0 (2)	0.0 (2)	0.2 (32)	2.0 (363)	2.2 (399)
JUN	0.1 (25)	0.0 (0)	0.1 (13)	1.2 (243)	1.3 (256)	0.1 (23)	0.6 (105)	0.7 (128)	0.0 (0)	0.0 (0)	0.0 (1)	0.1 (14)	1.4 (255)	1.5 (270)
JUL	0.0 (6)	0.0 (0)	0.0 (8)	0.5 (106)	0.6 (115)	0.0 (5)	0.6 (107)	0.6 (112)	0.0 (0)	0.0 (0)	0.0 (0)	0.1 (9)	0.8 (144)	0.8 (154)
AUG	0.1 (20)	0.0 (0)	0.0 (6)	0.2 (45)	0.3 (51)	0.1 (18)	0.6 (107)	0.7 (125)	0.0 (0)	0.0 (0)	0.0 (1)	0.0 (8)	0.7 (122)	0.7 (130)
SEP	0.3 (61)	0.0 (1)	0.0 (4)	0.2 (46)	0.3 (51)	0.3 (56)	0.4 (71)	0.7 (127)	0.0 (0)	0.0 (1)	0.0 (2)	0.0 (8)	0.6 (115)	0.7 (126)
<b>Total</b>	<b>14.8 (2923)</b>	<b>0.4 (79)</b>	<b>3.8 (758)</b>	<b>10.6 (2094)</b>	<b>14.8 (2930)</b>	<b>14.7 (2685)</b>	<b>3.7 (680)</b>	<b>18.4 (3364)</b>	<b>0.4 (79)</b>	<b>0.2 (39)</b>	<b>0.7 (121)</b>	<b>4.1 (742)</b>	<b>13.1 (2385)</b>	<b>18.4 (3366)</b>

### Dry Period

	Pre-Development					Post-Development with PDFs								
	INFLOW	OUIFLOW				INFLOW			OUIFLOW					
	Precipitation	Runoff to Cristianitos Crk	GW Outflow	ET	Total	Precipitation	Irrigation	Total	Runoff to Cristianitos Crk	Stored Runoff for GC Irrig	Runoff Diverted to Gabino	GW Outflow	ET	Total
OCT	0.3 (58)	0.0 (1)	0.0 (3)	0.3 (67)	0.4 (71)	0.3 (53)	0.2 (43)	0.5 (96)	0.0 (0)	0.0 (1)	0.0 (2)	0.0 (6)	0.6 (112)	0.7 (121)
NOV	1.6 (322)	0.0 (8)	0.0 (5)	0.6 (120)	0.7 (133)	1.6 (296)	0.1 (19)	1.7 (315)	0.0 (6)	0.0 (5)	0.1 (14)	0.1 (11)	0.8 (137)	0.9 (173)
DEC	2.1 (418)	0.1 (11)	0.1 (21)	0.7 (134)	0.8 (166)	2.1 (384)	0.1 (13)	2.2 (397)	0.1 (10)	0.0 (4)	0.1 (18)	0.2 (36)	0.8 (140)	1.1 (208)
JAN	2.5 (493)	0.1 (15)	0.3 (51)	0.8 (153)	1.1 (219)	2.5 (453)	0.1 (11)	2.5 (464)	0.1 (16)	0.0 (6)	0.1 (21)	0.4 (66)	0.9 (157)	1.5 (265)
FEB	2.2 (429)	0.1 (11)	0.5 (100)	1.0 (195)	1.5 (306)	2.2 (394)	0.1 (9)	2.2 (404)	0.1 (11)	0.0 (5)	0.1 (18)	0.5 (97)	1.1 (197)	1.8 (328)
MAR	1.7 (339)	0.0 (7)	0.5 (105)	1.5 (287)	2.0 (399)	1.7 (312)	0.2 (37)	1.9 (349)	0.0 (5)	0.0 (9)	0.1 (15)	0.5 (96)	1.6 (290)	2.3 (416)
APR	1.1 (214)	0.0 (4)	0.3 (55)	1.8 (354)	2.1 (412)	1.1 (197)	0.4 (69)	1.5 (266)	0.0 (2)	0.0 (5)	0.0 (9)	0.3 (54)	2.0 (360)	2.3 (429)
MAY	0.3 (68)	0.0 (1)	0.1 (17)	1.7 (335)	1.8 (353)	0.3 (63)	0.5 (88)	0.8 (151)	0.0 (0)	0.0 (1)	0.0 (2)	0.1 (19)	1.9 (343)	2.0 (366)
JUN	0.1 (18)	0.0 (0)	0.0 (8)	1.1 (209)	1.1 (218)	0.1 (16)	0.6 (105)	0.7 (121)	0.0 (0)	0.0 (0)	0.0 (0)	0.1 (10)	1.2 (224)	1.3 (234)
JUL	0.0 (7)	0.0 (0)	0.0 (6)	0.5 (91)	0.5 (97)	0.0 (7)	0.6 (107)	0.6 (113)	0.0 (0)	0.0 (0)	0.0 (0)	0.0 (7)	0.7 (136)	0.8 (142)
AUG	0.1 (22)	0.0 (0)	0.0 (4)	0.2 (40)	0.2 (44)	0.1 (21)	0.6 (107)	0.7 (127)	0.0 (0)	0.0 (0)	0.0 (1)	0.0 (6)	0.7 (121)	0.7 (128)
SEP	0.3 (58)	0.0 (1)	0.0 (3)	0.2 (45)	0.2 (49)	0.3 (54)	0.4 (71)	0.7 (124)	0.0 (0)	0.0 (1)	0.0 (2)	0.0 (7)	0.6 (114)	0.7 (124)
<b>Total</b>	<b>12.4 (2448)</b>	<b>0.3 (59)</b>	<b>1.9 (376)</b>	<b>10.3 (2030)</b>	<b>12.5 (2466)</b>	<b>12.3 (2248)</b>	<b>3.7 (679)</b>	<b>16.0 (2928)</b>	<b>0.3 (51)</b>	<b>0.2 (36)</b>	<b>0.6 (102)</b>	<b>2.3 (415)</b>	<b>12.8 (2331)</b>	<b>16.1 (2935)</b>

### Wet Period

	Pre-Development					Post-Development with PDFs								
	INFLOW	OUIFLOW				INFLOW			OUIFLOW					
	Precipitation	Runoff to Cristianitos Crk	GW Outflow	ET	Total	Precipitation	Irrigation	Total	Runoff to Cristianitos Crk	Stored Runoff for GC Irrig	Runoff Diverted to Gabino	GW Outflow	ET	Total
OCT	0.3 (57)	0.0 (1)	0.0 (5)	0.2 (43)	0.2 (49)	0.3 (53)	0.2 (43)	0.5 (96)	0.0 (0)	0.0 (1)	0.0 (2)	0.0 (7)	0.5 (92)	0.6 (102)
NOV	1.3 (249)	0.0 (4)	0.0 (5)	0.5 (95)	0.5 (105)	1.3 (228)	0.1 (19)	1.4 (247)	0.0 (3)	0.0 (4)	0.1 (10)	0.1 (10)	0.6 (118)	0.8 (144)
DEC	1.7 (345)	0.0 (9)	0.1 (19)	0.6 (114)	0.7 (142)	1.7 (317)	0.1 (13)	1.8 (330)	0.0 (8)	0.0 (4)	0.1 (16)	0.2 (34)	0.7 (124)	1.0 (185)
JAN	5.2 (1023)	0.2 (36)	1.4 (277)	0.8 (151)	2.4 (464)	5.1 (939)	0.1 (12)	5.2 (951)	0.2 (44)	0.0 (6)	0.2 (40)	1.5 (265)	0.9 (156)	2.8 (511)
FEB	5.1 (1002)	0.2 (39)	2.5 (488)	1.0 (199)	3.7 (727)	5.0 (920)	0.1 (9)	5.1 (929)	0.3 (48)	0.0 (5)	0.2 (40)	2.3 (424)	1.1 (202)	3.9 (720)
MAR	4.4 (868)	0.1 (26)	2.5 (494)	1.5 (300)	4.2 (821)	4.4 (797)	0.2 (36)	4.6 (833)	0.2 (32)	0.1 (11)	0.2 (38)	2.4 (434)	1.7 (304)	4.5 (819)
APR	1.0 (191)	0.0 (3)	0.8 (162)	1.9 (372)	2.7 (537)	1.0 (175)	0.4 (70)	1.3 (245)	0.0 (2)	0.1 (10)	0.0 (8)	0.8 (144)	2.1 (378)	3.0 (542)
MAY	0.4 (70)	0.0 (1)	0.3 (61)	2.0 (398)	2.3 (460)	0.4 (65)	0.5 (90)	0.8 (154)	0.0 (1)	0.0 (2)	0.0 (3)	0.3 (57)	2.2 (405)	2.6 (468)
JUN	0.2 (39)	0.0 (1)	0.1 (24)	1.6 (313)	1.7 (338)	0.2 (36)	0.6 (105)	0.8 (141)	0.0 (0)	0.0 (0)	0.0 (1)	0.1 (24)	1.8 (321)	1.9 (347)
JUL	0.0 (2)	0.0 (0)	0.1 (14)	0.7 (138)	0.8 (152)	0.0 (2)	0.6 (107)	0.6 (109)	0.0 (0)	0.0 (0)	0.0 (0)	0.1 (15)	0.9 (162)	1.0 (177)
AUG	0.1 (15)	0.0 (0)	0.0 (10)	0.3 (55)	0.3 (65)	0.1 (14)	0.6 (107)	0.7 (120)	0.0 (0)	0.0 (0)	0.0 (1)	0.1 (11)	0.7 (123)	0.7 (135)
SEP	0.3 (68)	0.0 (1)	0.0 (7)	0.2 (49)	0.3 (57)	0.3 (62)	0.4 (70)	0.7 (133)	0.0 (0)	0.0 (1)	0.0 (2)	0.1 (10)	0.6 (116)	0.7 (129)
<b>Total</b>	<b>19.9 (3929)</b>	<b>0.6 (122)</b>	<b>7.9 (1565)</b>	<b>11.3 (2228)</b>	<b>19.8 (3915)</b>	<b>19.8 (3608)</b>	<b>3.7 (681)</b>	<b>23.5 (4290)</b>	<b>0.8 (138)</b>	<b>0.2 (44)</b>	<b>0.9 (162)</b>	<b>7.9 (1434)</b>	<b>13.7 (2500)</b>	<b>23.4 (4278)</b>

# Cristianitos (Alternative B-4) – PA6<sup>1</sup>

Pre-dev area = 493 acres

Post-dev area = 515 acres

## All Years

	Pre-Development <sup>2</sup>					Post-Development with PDFs <sup>3</sup>								
	INFLOW	O U T F L O W				INFLOW			O U T F L O W					
	Precipitation	Runoff to Cristianitos Crk	GW Outflow	ET	Total	Precipitation	Irrigation	Total	Runoff to Cristianitos Crk	Stored Runoff for GC Irrig <sup>4</sup>	Runoff Diverted to Gabino	GW Outflow	ET	Total
OCT	0.3 (12)	0.0 (0)	0.0 (1)	0.3 (12)	0.3 (13)	0.3 (13)	0.6 (26)	0.9 (39)	0.0 (0)	0.0 (1)	0.0 (0)	0.1 (3)	1.1 (46)	1.1 (49)
NOV	1.5 (63)	0.1 (3)	0.0 (1)	0.5 (21)	0.6 (24)	1.5 (66)	0.3 (12)	1.8 (77)	0.0 (1)	0.1 (4)	0.0 (0)	0.1 (4)	0.9 (41)	1.2 (50)
DEC	2.0 (84)	0.1 (4)	0.1 (4)	0.6 (23)	0.7 (31)	2.0 (87)	0.2 (8)	2.2 (95)	0.0 (2)	0.1 (4)	0.0 (0)	0.3 (15)	0.8 (36)	1.3 (57)
JAN	3.4 (141)	0.1 (6)	0.7 (27)	0.7 (27)	1.5 (61)	3.4 (146)	0.2 (7)	3.6 (153)	0.2 (7)	0.1 (6)	0.0 (0)	1.0 (44)	0.9 (39)	2.2 (95)
FEB	3.2 (130)	0.1 (6)	1.2 (51)	0.8 (34)	2.2 (91)	3.1 (135)	0.1 (6)	3.3 (141)	0.2 (7)	0.1 (5)	0.0 (0)	1.3 (58)	1.1 (47)	2.7 (117)
MAR	2.6 (108)	0.1 (4)	1.3 (53)	1.2 (51)	2.6 (108)	2.6 (112)	0.5 (23)	3.2 (135)	0.1 (3)	0.2 (10)	0.0 (0)	1.4 (60)	1.6 (70)	3.3 (143)
APR	1.1 (44)	0.0 (2)	0.5 (20)	1.6 (64)	2.1 (86)	1.1 (45)	1.0 (44)	2.1 (90)	0.0 (0)	0.2 (7)	0.0 (0)	0.6 (25)	2.1 (90)	2.8 (122)
MAY	0.4 (15)	0.0 (0)	0.2 (7)	1.7 (69)	1.9 (77)	0.4 (15)	1.3 (56)	1.7 (72)	0.0 (0)	0.0 (2)	0.0 (0)	0.2 (10)	2.3 (100)	2.6 (112)
JUN	0.1 (5)	0.0 (0)	0.1 (3)	1.5 (62)	1.6 (65)	0.1 (5)	1.5 (66)	1.7 (72)	0.0 (0)	0.0 (0)	0.0 (0)	0.1 (5)	2.3 (98)	2.4 (103)
JUL	0.0 (1)	0.0 (0)	0.0 (2)	0.9 (38)	1.0 (39)	0.0 (1)	1.6 (67)	1.6 (68)	0.0 (0)	0.0 (0)	0.0 (0)	0.1 (3)	2.0 (84)	2.0 (87)
AUG	0.1 (4)	0.0 (0)	0.0 (1)	0.3 (14)	0.4 (15)	0.1 (4)	1.6 (67)	1.7 (71)	0.0 (0)	0.0 (0)	0.0 (0)	0.1 (3)	1.7 (71)	1.7 (74)
SEP	0.3 (13)	0.0 (0)	0.0 (1)	0.2 (10)	0.3 (11)	0.3 (13)	1.0 (44)	1.3 (57)	0.0 (0)	0.0 (1)	0.0 (0)	0.1 (3)	1.3 (57)	1.4 (61)
<b>Total</b>	<b>15.1 (620)</b>	<b>0.6 (26)</b>	<b>4.2 (171)</b>	<b>10.3 (425)</b>	<b>15.1 (622)</b>	<b>15.0 (643)</b>	<b>10.0 (427)</b>	<b>25.0 (1070)</b>	<b>0.5 (20)</b>	<b>0.9 (39)</b>	<b>0.0 (0)</b>	<b>5.4 (232)</b>	<b>18.2 (780)</b>	<b>25.0 (1070)</b>

## Dry Period

	Pre-Development <sup>2</sup>					Post-Development with PDFs <sup>3</sup>								
	INFLOW	O U T F L O W				INFLOW			O U T F L O W					
	Precipitation	Runoff to Cristianitos Crk	GW Outflow	ET	Total	Precipitation	Irrigation	Total	Runoff to Cristianitos Crk	Stored Runoff for GC Irrig <sup>4</sup>	Runoff Diverted to Gabino	GW Outflow	ET	Total
OCT	0.3 (12)	0.0 (0)	0.0 (1)	0.3 (13)	0.4 (14)	0.3 (13)	0.6 (26)	0.9 (39)	0.0 (0)	0.0 (1)	0.0 (0)	0.1 (3)	1.1 (47)	1.2 (50)
NOV	1.7 (68)	0.1 (3)	0.0 (1)	0.5 (22)	0.6 (26)	1.7 (71)	0.3 (11)	1.9 (82)	0.0 (1)	0.1 (5)	0.0 (0)	0.1 (5)	1.0 (42)	1.2 (52)
DEC	2.2 (89)	0.1 (4)	0.1 (4)	0.6 (24)	0.8 (32)	2.1 (92)	0.2 (8)	2.3 (100)	0.0 (2)	0.1 (4)	0.0 (0)	0.3 (15)	0.9 (36)	1.3 (57)
JAN	2.5 (105)	0.1 (4)	0.3 (11)	0.7 (27)	1.0 (43)	2.5 (108)	0.2 (7)	2.7 (116)	0.1 (3)	0.1 (6)	0.0 (0)	0.6 (26)	0.9 (38)	1.7 (73)
FEB	2.2 (91)	0.1 (4)	0.6 (24)	0.8 (34)	1.5 (62)	2.2 (95)	0.1 (6)	2.3 (101)	0.1 (3)	0.1 (5)	0.0 (0)	0.8 (32)	1.1 (47)	2.0 (87)
MAR	1.8 (72)	0.1 (3)	0.6 (25)	1.2 (50)	1.9 (77)	1.7 (75)	0.6 (24)	2.3 (98)	0.0 (1)	0.2 (9)	0.0 (0)	0.7 (30)	1.6 (70)	2.5 (109)
APR	1.1 (45)	0.0 (2)	0.3 (13)	1.6 (64)	1.9 (78)	1.1 (47)	1.0 (44)	2.1 (91)	0.0 (0)	0.1 (5)	0.0 (0)	0.4 (18)	2.1 (90)	2.6 (113)
MAY	0.4 (15)	0.0 (0)	0.1 (4)	1.7 (68)	1.8 (73)	0.4 (15)	1.3 (56)	1.7 (71)	0.0 (0)	0.0 (1)	0.0 (0)	0.2 (7)	2.3 (100)	2.5 (108)
JUN	0.1 (4)	0.0 (0)	0.0 (2)	1.4 (58)	1.5 (60)	0.1 (4)	1.5 (66)	1.6 (70)	0.0 (0)	0.0 (0)	0.0 (0)	0.1 (3)	2.2 (95)	2.3 (98)
JUL	0.0 (2)	0.0 (0)	0.0 (1)	0.8 (33)	0.8 (35)	0.0 (2)	1.6 (67)	1.6 (69)	0.0 (0)	0.0 (0)	0.0 (0)	0.1 (2)	1.9 (82)	2.0 (84)
AUG	0.1 (5)	0.0 (0)	0.0 (1)	0.3 (12)	0.3 (13)	0.1 (5)	1.6 (67)	1.7 (72)	0.0 (0)	0.0 (0)	0.0 (0)	0.1 (2)	1.6 (71)	1.7 (73)
SEP	0.3 (12)	0.0 (0)	0.0 (1)	0.2 (10)	0.3 (11)	0.3 (13)	1.0 (44)	1.3 (57)	0.0 (0)	0.0 (1)	0.0 (0)	0.1 (3)	1.3 (57)	1.4 (61)
<b>Total</b>	<b>12.6 (519)</b>	<b>0.5 (21)</b>	<b>2.1 (86)</b>	<b>10.1 (416)</b>	<b>12.7 (523)</b>	<b>12.6 (539)</b>	<b>10.0 (427)</b>	<b>22.5 (966)</b>	<b>0.2 (10)</b>	<b>0.8 (36)</b>	<b>0.0 (0)</b>	<b>3.4 (146)</b>	<b>18.1 (774)</b>	<b>22.5 (966)</b>

## Wet Period

	Pre-Development <sup>2</sup>					Post-Development with PDFs <sup>3</sup>								
	INFLOW	O U T F L O W				INFLOW			O U T F L O W					
	Precipitation	Runoff to Cristianitos Crk	GW Outflow	ET	Total	Precipitation	Irrigation	Total	Runoff to Cristianitos Crk	Stored Runoff for GC Irrig <sup>4</sup>	Runoff Diverted to Gabino	GW Outflow	ET	Total
OCT	0.3 (12)	0.0 (0)	0.0 (1)	0.2 (10)	0.3 (11)	0.3 (13)	0.6 (27)	0.9 (39)	0.0 (0)	0.0 (1)	0.0 (0)	0.1 (2)	1.0 (45)	1.1 (48)
NOV	1.3 (53)	0.1 (2)	0.0 (1)	0.4 (18)	0.5 (21)	1.3 (55)	0.3 (12)	1.5 (66)	0.0 (0)	0.1 (4)	0.0 (0)	0.1 (4)	0.9 (39)	1.1 (46)
DEC	1.8 (73)	0.1 (3)	0.1 (4)	0.5 (21)	0.7 (28)	1.8 (76)	0.2 (8)	2.0 (84)	0.0 (1)	0.1 (4)	0.0 (0)	0.4 (15)	0.8 (34)	1.3 (55)
JAN	5.3 (217)	0.2 (9)	1.5 (62)	0.7 (27)	2.4 (99)	5.2 (225)	0.2 (7)	5.4 (232)	0.3 (14)	0.1 (6)	0.0 (0)	1.9 (82)	0.9 (39)	3.3 (141)
FEB	5.2 (212)	0.2 (9)	2.6 (108)	0.8 (35)	3.7 (152)	5.1 (220)	0.1 (6)	5.3 (226)	0.4 (16)	0.1 (5)	0.0 (0)	2.6 (112)	1.1 (48)	4.2 (182)
MAR	4.5 (184)	0.2 (8)	2.7 (112)	1.3 (52)	4.2 (172)	4.5 (191)	0.5 (23)	5.0 (214)	0.2 (9)	0.3 (11)	0.0 (0)	2.9 (122)	1.7 (71)	5.0 (214)
APR	1.0 (40)	0.0 (2)	0.9 (37)	1.5 (63)	2.5 (102)	1.0 (42)	1.0 (45)	2.0 (87)	0.0 (0)	0.2 (10)	0.0 (0)	1.0 (41)	2.1 (90)	3.3 (141)
MAY	0.4 (15)	0.0 (1)	0.3 (14)	1.7 (72)	2.1 (86)	0.4 (15)	1.3 (57)	1.7 (72)	0.0 (0)	0.1 (2)	0.0 (0)	0.4 (17)	2.4 (102)	2.8 (122)
JUN	0.2 (8)	0.0 (0)	0.1 (5)	1.7 (71)	1.9 (77)	0.2 (9)	1.5 (66)	1.7 (75)	0.0 (0)	0.0 (0)	0.0 (0)	0.2 (7)	2.5 (106)	2.6 (113)
JUL	0.0 (0)	0.0 (0)	0.1 (3)	1.1 (47)	1.2 (50)	0.0 (0)	1.6 (67)	1.6 (67)	0.0 (0)	0.0 (0)	0.0 (0)	0.1 (4)	2.1 (89)	2.2 (93)
AUG	0.1 (3)	0.0 (0)	0.1 (2)	0.4 (18)	0.5 (20)	0.1 (3)	1.6 (67)	1.6 (70)	0.0 (0)	0.0 (0)	0.0 (0)	0.1 (3)	1.7 (73)	1.8 (76)
SEP	0.4 (14)	0.0 (1)	0.0 (1)	0.3 (11)	0.3 (13)	0.3 (15)	1.0 (44)	1.4 (58)	0.0 (0)	0.0 (1)	0.0 (0)	0.1 (3)	1.3 (58)	1.4 (62)
<b>Total</b>	<b>20.3 (833)</b>	<b>0.9 (35)</b>	<b>8.5 (351)</b>	<b>10.8 (444)</b>	<b>20.2 (830)</b>	<b>20.1 (864)</b>	<b>10.0 (428)</b>	<b>30.1 (1292)</b>	<b>1.0 (42)</b>	<b>1.0 (44)</b>	<b>0.0 (0)</b>	<b>9.7 (414)</b>	<b>18.5 (792)</b>	<b>30.1 (1291)</b>

### Notes:

- (1) This includes all catchments that encompass the development areas in PA6. Because the catchment shapes change from pre- to post-, the results presented here include some open space outside of PA6. Thus, the total area is greater than the development area of PA6
- (2) The pre-development catchments include Catchments 56, 57, and 59-63.
- (3) The post-development catchments include Catchments CM1-4, 57, 59, 61, 63, and 59-63.
- (4) The golf course storage volume was approximated at 12 acre-ft. This exceeds the URQM sizing criteria (WEF, 1998), which was calculated to be 5.4 acre-ft.

# Cristianitos (Alternative B-4) – PA7<sup>1</sup>

Pre-dev area = 881 acres

Post-dev area = 680 acres

## All Years

	Pre-Development <sup>2</sup>					Post-Development with PDFs <sup>3</sup>								
	INFLOW	O U T F L O W				INFLOW			O U T F L O W					
	Precipitation	Runoff to Cristianitos Crk	GW Outflow	ET	Total	Precipitation	Irrigation	Total	Runoff to Cristianitos Crk	Stored Runoff for GC Irrig	Runoff Diverted to Gabino	GW Outflow	ET	Total
OCT	0.3 (22)	0.0 (0)	0.0 (2)	0.3 (21)	0.3 (23)	0.3 (17)	0.3 (17)	0.6 (33)	0.0 (0)	0.0 (0)	0.0 (2)	0.0 (3)	0.6 (33)	0.7 (38)
NOV	1.5 (112)	0.1 (4)	0.0 (3)	0.5 (37)	0.6 (44)	1.5 (86)	0.1 (7)	1.6 (93)	0.1 (4)	0.0 (0)	0.2 (13)	0.1 (5)	0.6 (36)	1.0 (58)
DEC	2.0 (148)	0.1 (6)	0.1 (11)	0.6 (41)	0.8 (58)	2.0 (113)	0.1 (5)	2.1 (118)	0.1 (7)	0.0 (0)	0.3 (18)	0.3 (15)	0.6 (35)	1.3 (75)
JAN	3.4 (249)	0.2 (15)	0.7 (51)	0.7 (48)	1.6 (114)	3.4 (190)	0.1 (4)	3.4 (194)	0.3 (17)	0.0 (0)	0.5 (27)	0.7 (41)	0.7 (41)	2.2 (126)
FEB	3.1 (230)	0.2 (14)	1.2 (87)	0.8 (61)	2.2 (162)	3.1 (176)	0.1 (3)	3.2 (179)	0.3 (15)	0.0 (0)	0.4 (25)	1.0 (58)	0.9 (50)	2.6 (148)
MAR	2.6 (191)	0.1 (9)	1.3 (92)	1.2 (90)	2.6 (191)	2.6 (146)	0.2 (13)	2.8 (159)	0.2 (10)	0.0 (0)	0.4 (22)	1.1 (61)	1.3 (74)	3.0 (167)
APR	1.1 (78)	0.0 (2)	0.5 (38)	1.5 (113)	2.1 (153)	1.0 (59)	0.4 (25)	1.5 (84)	0.0 (2)	0.0 (0)	0.1 (8)	0.5 (27)	1.6 (93)	2.3 (129)
MAY	0.4 (26)	0.0 (0)	0.2 (14)	1.7 (123)	1.9 (137)	0.3 (20)	0.6 (32)	0.9 (52)	0.0 (0)	0.0 (0)	0.0 (2)	0.2 (11)	1.8 (99)	2.0 (113)
JUN	0.1 (9)	0.0 (0)	0.1 (6)	1.4 (105)	1.5 (111)	0.1 (7)	0.7 (39)	0.8 (46)	0.0 (0)	0.0 (0)	0.0 (1)	0.1 (5)	1.4 (81)	1.5 (87)
JUL	0.0 (2)	0.0 (0)	0.0 (3)	0.8 (60)	0.9 (64)	0.0 (2)	0.7 (40)	0.7 (41)	0.0 (0)	0.0 (0)	0.0 (0)	0.1 (3)	0.9 (52)	1.0 (55)
AUG	0.1 (7)	0.0 (0)	0.0 (2)	0.3 (23)	0.3 (25)	0.1 (6)	0.7 (40)	0.8 (45)	0.0 (0)	0.0 (0)	0.0 (1)	0.1 (3)	0.8 (43)	0.8 (46)
SEP	0.3 (23)	0.0 (0)	0.0 (2)	0.2 (17)	0.3 (19)	0.3 (18)	0.5 (27)	0.8 (44)	0.0 (0)	0.0 (0)	0.0 (2)	0.1 (3)	0.7 (38)	0.8 (44)
Total	15.0 (1099)	0.7 (52)	4.2 (310)	10.1 (739)	15.0 (1101)	14.8 (837)	4.4 (252)	19.2 (1089)	1.0 (57)	0.0 (0)	2.1 (121)	4.1 (234)	11.9 (676)	19.2 (1088)

## Dry Period

	Pre-Development <sup>2</sup>					Post-Development with PDFs <sup>3</sup>								
	INFLOW	O U T F L O W				INFLOW			O U T F L O W					
	Precipitation	Runoff to Cristianitos Crk	GW Outflow	ET	Total	Precipitation	Irrigation	Total	Runoff to Cristianitos Crk	Stored Runoff for GC Irrig	Runoff Diverted to Gabino	GW Outflow	ET	Total
OCT	0.3 (22)	0.0 (0)	0.0 (1)	0.3 (23)	0.3 (25)	0.3 (17)	0.3 (17)	0.6 (33)	0.0 (0)	0.0 (0)	0.0 (2)	0.0 (3)	0.6 (35)	0.7 (40)
NOV	1.6 (121)	0.1 (5)	0.0 (3)	0.5 (39)	0.6 (47)	1.6 (92)	0.1 (7)	1.8 (99)	0.1 (5)	0.0 (0)	0.2 (14)	0.1 (5)	0.7 (38)	1.1 (62)
DEC	2.1 (157)	0.1 (7)	0.1 (10)	0.6 (43)	0.8 (60)	2.1 (120)	0.1 (5)	2.2 (125)	0.1 (8)	0.0 (0)	0.3 (18)	0.3 (15)	0.6 (37)	1.4 (78)
JAN	2.5 (185)	0.1 (10)	0.3 (24)	0.7 (48)	1.1 (82)	2.5 (141)	0.1 (4)	2.6 (145)	0.2 (12)	0.0 (0)	0.4 (21)	0.4 (24)	0.7 (40)	1.7 (98)
FEB	2.2 (161)	0.1 (7)	0.6 (42)	0.8 (60)	1.5 (110)	2.2 (123)	0.1 (3)	2.2 (126)	0.1 (7)	0.0 (0)	0.3 (18)	0.6 (31)	0.9 (50)	1.9 (106)
MAR	1.7 (127)	0.1 (4)	0.6 (44)	1.2 (89)	1.9 (137)	1.7 (97)	0.2 (13)	1.9 (110)	0.1 (4)	0.0 (0)	0.3 (15)	0.5 (31)	1.3 (73)	2.2 (123)
APR	1.1 (81)	0.0 (2)	0.3 (24)	1.5 (114)	1.9 (140)	1.1 (61)	0.4 (25)	1.5 (86)	0.0 (2)	0.0 (0)	0.2 (9)	0.3 (18)	1.6 (93)	2.1 (121)
MAY	0.3 (26)	0.0 (0)	0.1 (8)	1.6 (121)	1.8 (129)	0.3 (19)	0.6 (32)	0.9 (52)	0.0 (0)	0.0 (0)	0.0 (2)	0.1 (8)	1.7 (97)	1.9 (107)
JUN	0.1 (7)	0.0 (0)	0.1 (4)	1.3 (97)	1.4 (101)	0.1 (5)	0.7 (39)	0.8 (44)	0.0 (0)	0.0 (0)	0.0 (0)	0.1 (4)	1.3 (74)	1.4 (79)
JUL	0.0 (3)	0.0 (0)	0.0 (2)	0.7 (53)	0.8 (55)	0.0 (2)	0.7 (40)	0.7 (42)	0.0 (0)	0.0 (0)	0.0 (0)	0.0 (2)	0.9 (49)	0.9 (51)
AUG	0.1 (8)	0.0 (0)	0.0 (2)	0.3 (19)	0.3 (21)	0.1 (6)	0.7 (40)	0.8 (46)	0.0 (0)	0.0 (0)	0.0 (1)	0.0 (2)	0.7 (42)	0.8 (45)
SEP	0.3 (22)	0.0 (0)	0.0 (1)	0.2 (16)	0.2 (18)	0.3 (17)	0.5 (27)	0.8 (44)	0.0 (0)	0.0 (0)	0.0 (2)	0.0 (3)	0.7 (38)	0.8 (43)
Total	12.5 (920)	0.5 (36)	2.3 (167)	9.8 (722)	12.6 (926)	12.4 (701)	4.4 (252)	16.8 (952)	0.7 (39)	0.0 (0)	1.8 (102)	2.6 (146)	11.7 (665)	16.8 (953)

## Wet Period

	Pre-Development <sup>2</sup>					Post-Development with PDFs <sup>3</sup>								
	INFLOW	O U T F L O W				INFLOW			O U T F L O W					
	Precipitation	Runoff to Cristianitos Crk	GW Outflow	ET	Total	Precipitation	Irrigation	Total	Runoff to Cristianitos Crk	Stored Runoff for GC Irrig	Runoff Diverted to Gabino	GW Outflow	ET	Total
OCT	0.3 (22)	0.0 (0)	0.0 (2)	0.2 (16)	0.3 (18)	0.3 (16)	0.3 (17)	0.6 (33)	0.0 (0)	0.0 (0)	0.0 (2)	0.0 (3)	0.5 (30)	0.6 (35)
NOV	1.3 (94)	0.0 (2)	0.0 (3)	0.4 (31)	0.5 (36)	1.3 (71)	0.1 (7)	1.4 (78)	0.0 (2)	0.0 (0)	0.2 (10)	0.1 (5)	0.6 (33)	0.9 (50)
DEC	1.8 (130)	0.1 (6)	0.2 (11)	0.5 (37)	0.7 (54)	1.7 (99)	0.1 (5)	1.8 (104)	0.1 (7)	0.0 (0)	0.3 (16)	0.3 (15)	0.6 (33)	1.2 (70)
JAN	5.2 (385)	0.4 (26)	1.5 (108)	0.7 (49)	2.5 (182)	5.2 (293)	0.1 (4)	5.3 (298)	0.5 (29)	0.0 (0)	0.7 (40)	1.4 (77)	0.7 (42)	3.3 (187)
FEB	5.1 (377)	0.4 (30)	2.5 (182)	0.8 (62)	3.7 (274)	5.1 (287)	0.1 (3)	5.1 (290)	0.5 (31)	0.0 (0)	0.7 (40)	2.0 (114)	0.9 (52)	4.2 (238)
MAR	4.4 (326)	0.2 (18)	2.6 (194)	1.3 (93)	4.1 (305)	4.4 (249)	0.2 (13)	4.6 (262)	0.4 (22)	0.0 (0)	0.7 (38)	2.2 (125)	1.4 (77)	4.6 (261)
APR	1.0 (72)	0.0 (2)	0.9 (66)	1.5 (113)	2.5 (181)	1.0 (55)	0.4 (25)	1.4 (80)	0.0 (1)	0.0 (0)	0.1 (8)	0.8 (45)	1.6 (93)	2.6 (147)
MAY	0.4 (26)	0.0 (0)	0.4 (26)	1.7 (127)	2.1 (154)	0.4 (20)	0.6 (33)	0.9 (53)	0.0 (1)	0.0 (0)	0.0 (3)	0.3 (19)	1.8 (103)	2.2 (125)
JUN	0.2 (15)	0.0 (0)	0.1 (10)	1.7 (122)	1.8 (132)	0.2 (11)	0.7 (39)	0.9 (50)	0.0 (0)	0.0 (0)	0.0 (1)	0.1 (8)	1.7 (96)	1.9 (105)
JUL	0.0 (1)	0.0 (0)	0.1 (6)	1.0 (76)	1.1 (82)	0.0 (1)	0.7 (40)	0.7 (40)	0.0 (0)	0.0 (0)	0.0 (0)	0.1 (5)	1.0 (59)	1.1 (64)
AUG	0.1 (6)	0.0 (0)	0.1 (4)	0.4 (31)	0.5 (35)	0.1 (4)	0.7 (40)	0.8 (44)	0.0 (0)	0.0 (0)	0.0 (1)	0.1 (4)	0.8 (44)	0.8 (48)
SEP	0.3 (26)	0.0 (0)	0.0 (3)	0.2 (18)	0.3 (21)	0.3 (20)	0.5 (27)	0.8 (46)	0.0 (0)	0.0 (0)	0.0 (2)	0.1 (4)	0.7 (38)	0.8 (45)
Total	20.1 (1478)	1.2 (85)	8.4 (614)	10.6 (775)	20.1 (1473)	19.9 (1126)	4.5 (252)	24.3 (1378)	1.6 (93)	0.0 (0)	2.9 (162)	7.4 (421)	12.3 (699)	24.3 (1375)

### Notes:

- (1) This includes all catchments that encompass the development areas in PA7. Because the catchment shapes change from pre- to post-, the results presented here include some open space outside of PA7. Thus, the total area is greater than the development area of PA7.
- (2) The pre-development catchments include Catchments 39, 43, 44, 45, 47, 48, 51, 52, 54, 55, and 58.
- (3) The post-development catchments include Catchments 39, 43, 44, 45, 47, 48, 51, 52, 54, 55, 58, PA7-9, PA7-10, PA7-11, PA7-14, and PA7-16.

# Lower Gabino (Alternative B-4) - Total Sub-basin<sup>1</sup>

Pre-dev area = 1566 acres

Post-dev area = 1740 acres

## All Years

	Pre-Development <sup>1</sup>					Post-Development with PDFs <sup>2</sup>									
	INFLOW	OUTFLOW				INFLOW				OUTFLOW					
	Precipitation	Runoff to Gabino Crk	GW Outflow	ET	Total	Precipitation	Irrigation	Diverted Runoff from Cristianitos <sup>4</sup>	Total	Runoff to Gabino Crk <sup>5</sup>	Diverted Runoff from Cristianitos <sup>4</sup>	Stored Runoff for GC Irrig <sup>6</sup>	GW Outflow	ET	Total
OCT	0.3 (42)	0.0 (1)	0.0 (0)	0.4 (44)	0.4 (45)	0.3 (47)	0.3 (37)	0.0 (2)	0.6 (86)	0.0 (5)	0.0 (2)	0.0 (0)	0.0 (3)	0.6 (86)	0.7 (97)
NOV	1.8 (220)	0.0 (4)	0.0 (6)	0.6 (78)	0.7 (89)	1.7 (245)	0.1 (16)	0.1 (13)	1.9 (273)	0.2 (34)	0.1 (13)	0.0 (2)	0.1 (17)	0.7 (104)	1.2 (170)
DEC	2.3 (290)	0.0 (6)	0.3 (33)	0.7 (88)	1.0 (127)	2.2 (323)	0.1 (11)	0.1 (17)	2.4 (352)	0.3 (49)	0.1 (17)	0.0 (2)	0.3 (50)	0.7 (106)	1.5 (224)
JAN	3.9 (488)	0.1 (11)	1.3 (160)	0.8 (103)	2.2 (274)	3.7 (543)	0.1 (10)	0.2 (27)	4.0 (580)	0.6 (86)	0.2 (27)	0.0 (3)	1.1 (166)	0.8 (121)	2.8 (404)
FEB	3.6 (450)	0.1 (11)	1.7 (210)	1.1 (132)	2.8 (353)	3.5 (502)	0.1 (7)	0.2 (25)	3.7 (534)	0.5 (78)	0.2 (25)	0.0 (3)	1.4 (208)	1.0 (152)	3.2 (465)
MAR	3.0 (374)	0.1 (8)	1.5 (189)	1.6 (195)	3.2 (392)	2.9 (416)	0.2 (29)	0.2 (22)	3.2 (468)	0.4 (64)	0.2 (22)	0.0 (5)	1.3 (181)	1.6 (226)	3.4 (499)
APR	1.2 (152)	0.0 (3)	0.3 (40)	1.9 (242)	2.3 (285)	1.2 (169)	0.4 (56)	0.1 (8)	1.6 (234)	0.1 (21)	0.1 (8)	0.0 (3)	0.3 (44)	1.9 (279)	2.5 (356)
MAY	0.4 (51)	0.0 (1)	0.1 (8)	2.0 (246)	2.1 (255)	0.4 (56)	0.5 (72)	0.0 (2)	0.9 (131)	0.0 (6)	0.0 (2)	0.0 (0)	0.1 (12)	2.0 (285)	2.1 (305)
JUN	0.1 (18)	0.0 (0)	0.0 (2)	1.5 (181)	1.5 (183)	0.1 (20)	0.6 (86)	0.0 (1)	0.7 (107)	0.0 (2)	0.0 (1)	0.0 (0)	0.0 (3)	1.5 (219)	1.5 (224)
JUL	0.0 (4)	0.0 (0)	0.0 (1)	0.6 (75)	0.6 (76)	0.0 (5)	0.6 (88)	0.0 (0)	0.6 (93)	0.0 (0)	0.0 (0)	0.0 (0)	0.0 (2)	0.9 (127)	0.9 (129)
AUG	0.1 (15)	0.0 (0)	0.0 (1)	0.3 (39)	0.3 (40)	0.1 (16)	0.6 (88)	0.0 (1)	0.7 (105)	0.0 (2)	0.0 (1)	0.0 (0)	0.0 (3)	0.8 (109)	0.8 (115)
SEP	0.4 (45)	0.0 (1)	0.0 (0)	0.3 (37)	0.3 (38)	0.3 (50)	0.4 (59)	0.0 (2)	0.8 (112)	0.0 (6)	0.0 (2)	0.0 (0)	0.0 (5)	0.7 (98)	0.8 (111)
Total	17.3 (2148)	0.4 (45)	5.2 (649)	11.8 (1461)	17.3 (2155)	16.5 (2392)	3.9 (560)	0.8 (121)	21.2 (3073)	2.4 (353)	0.8 (121)	0.1 (19)	4.8 (695)	13.2 (1912)	21.4 (3100)

## Dry Period

	Pre-Development <sup>1</sup>					Post-Development with PDFs <sup>2</sup>									
	INFLOW	OUTFLOW				INFLOW				OUTFLOW					
	Precipitation	Runoff to Gabino Crk	GW Outflow	ET	Total	Precipitation	Irrigation	Diverted Runoff from Cristianitos <sup>4</sup>	Total	Runoff to Gabino Crk <sup>5</sup>	Diverted Runoff from Cristianitos <sup>4</sup>	Stored Runoff for GC Irrig <sup>6</sup>	GW Outflow	ET	Total
OCT	0.3 (42)	0.0 (1)	0.0 (0)	0.4 (49)	0.4 (50)	0.3 (47)	0.3 (37)	0.0 (2)	0.6 (86)	0.0 (5)	0.0 (2)	0.0 (0)	0.0 (3)	0.6 (91)	0.7 (102)
NOV	1.9 (237)	0.0 (5)	0.1 (8)	0.7 (84)	0.8 (97)	1.8 (264)	0.1 (16)	0.1 (14)	2.0 (294)	0.3 (38)	0.1 (14)	0.0 (2)	0.1 (19)	0.8 (109)	1.3 (182)
DEC	2.5 (308)	0.1 (6)	0.3 (31)	0.7 (92)	1.0 (130)	2.4 (343)	0.1 (11)	0.1 (18)	2.6 (372)	0.4 (52)	0.1 (18)	0.0 (2)	0.4 (51)	0.8 (109)	1.6 (233)
JAN	2.9 (364)	0.1 (8)	0.6 (77)	0.8 (103)	1.5 (189)	2.8 (405)	0.1 (10)	0.1 (21)	3.0 (436)	0.4 (63)	0.1 (21)	0.0 (3)	0.6 (89)	0.8 (121)	2.0 (296)
FEB	2.5 (316)	0.1 (6)	0.9 (117)	1.1 (131)	2.0 (255)	2.4 (352)	0.1 (7)	0.1 (18)	2.6 (377)	0.3 (49)	0.1 (18)	0.0 (2)	0.8 (118)	1.0 (151)	2.3 (338)
MAR	2.0 (250)	0.0 (5)	0.7 (84)	1.6 (193)	2.3 (281)	1.9 (278)	0.2 (30)	0.1 (15)	2.2 (323)	0.3 (38)	0.1 (15)	0.0 (4)	0.6 (84)	1.5 (223)	2.5 (363)
APR	1.3 (158)	0.0 (3)	0.3 (32)	1.9 (238)	2.2 (273)	1.2 (176)	0.4 (56)	0.1 (9)	1.7 (240)	0.2 (22)	0.1 (9)	0.0 (2)	0.3 (36)	1.9 (275)	2.4 (343)
MAY	0.4 (50)	0.0 (1)	0.0 (3)	1.9 (237)	1.9 (240)	0.4 (56)	0.5 (72)	0.0 (2)	0.9 (130)	0.0 (5)	0.0 (2)	0.0 (0)	0.0 (7)	1.9 (275)	2.0 (289)
JUN	0.1 (13)	0.0 (0)	0.0 (1)	1.3 (167)	1.4 (168)	0.1 (14)	0.6 (86)	0.0 (0)	0.7 (101)	0.0 (1)	0.0 (0)	0.0 (0)	0.0 (3)	1.4 (205)	1.4 (209)
JUL	0.0 (5)	0.0 (0)	0.0 (1)	0.5 (68)	0.6 (69)	0.0 (6)	0.6 (88)	0.0 (0)	0.6 (94)	0.0 (0)	0.0 (0)	0.0 (0)	0.0 (2)	0.8 (122)	0.9 (124)
AUG	0.1 (16)	0.0 (0)	0.0 (0)	0.3 (38)	0.3 (39)	0.1 (18)	0.6 (88)	0.0 (1)	0.7 (107)	0.0 (2)	0.0 (1)	0.0 (0)	0.0 (3)	0.7 (108)	0.8 (114)
SEP	0.3 (43)	0.0 (1)	0.0 (0)	0.3 (36)	0.3 (37)	0.3 (48)	0.4 (59)	0.0 (2)	0.8 (109)	0.0 (6)	0.0 (2)	0.0 (0)	0.0 (5)	0.7 (97)	0.8 (110)
Total	14.5 (1802)	0.3 (35)	2.9 (356)	11.6 (1437)	14.7 (1828)	13.8 (2008)	3.9 (559)	0.7 (102)	18.4 (2669)	1.9 (282)	0.7 (102)	0.1 (16)	2.9 (419)	13.0 (1886)	18.6 (2704)

## Wet Period

	Pre-Development <sup>1</sup>					Post-Development with PDFs <sup>2</sup>									
	INFLOW	OUTFLOW				INFLOW				OUTFLOW					
	Precipitation	Runoff to Gabino Crk	GW Outflow	ET	Total	Precipitation	Irrigation	Diverted Runoff from Cristianitos <sup>4</sup>	Total	Runoff to Gabino Crk <sup>5</sup>	Diverted Runoff from Cristianitos <sup>4</sup>	Stored Runoff for GC Irrig <sup>6</sup>	GW Outflow	ET	Total
OCT	0.3 (42)	0.0 (1)	0.0 (0)	0.3 (34)	0.3 (35)	0.3 (47)	0.3 (37)	0.0 (2)	0.6 (86)	0.0 (5)	0.0 (2)	0.0 (0)	0.0 (2)	0.5 (77)	0.6 (87)
NOV	1.5 (182)	0.0 (4)	0.0 (1)	0.5 (67)	0.6 (71)	1.4 (203)	0.1 (16)	0.1 (10)	1.6 (229)	0.2 (27)	0.1 (10)	0.0 (2)	0.1 (12)	0.6 (93)	1.0 (144)
DEC	2.0 (252)	0.0 (5)	0.3 (35)	0.6 (79)	1.0 (120)	1.9 (281)	0.1 (12)	0.1 (16)	2.1 (308)	0.3 (42)	0.1 (16)	0.0 (2)	0.3 (48)	0.7 (98)	1.4 (205)
JAN	6.0 (750)	0.1 (18)	2.7 (333)	0.8 (102)	3.7 (454)	5.8 (835)	0.1 (10)	0.3 (40)	6.1 (885)	0.9 (136)	0.3 (40)	0.0 (3)	2.3 (330)	0.8 (122)	4.4 (632)
FEB	5.9 (734)	0.2 (19)	3.3 (407)	1.1 (134)	4.5 (560)	5.6 (817)	0.1 (7)	0.3 (40)	6.0 (865)	0.9 (138)	0.3 (40)	0.0 (3)	2.8 (399)	1.1 (156)	5.1 (735)
MAR	5.1 (637)	0.1 (15)	3.3 (411)	1.6 (201)	5.0 (626)	4.9 (709)	0.2 (29)	0.3 (38)	5.4 (776)	0.8 (118)	0.3 (38)	0.1 (8)	2.7 (389)	1.6 (233)	5.4 (786)
APR	1.1 (140)	0.0 (2)	0.5 (58)	2.0 (250)	2.5 (310)	1.1 (155)	0.4 (57)	0.1 (8)	1.5 (220)	0.1 (20)	0.1 (8)	0.0 (5)	0.4 (61)	2.0 (288)	2.6 (383)
MAY	0.4 (51)	0.0 (1)	0.2 (19)	2.1 (266)	2.3 (286)	0.4 (57)	0.5 (73)	0.0 (3)	0.9 (133)	0.0 (7)	0.0 (3)	0.0 (1)	0.2 (22)	2.1 (306)	2.3 (339)
JUN	0.2 (29)	0.0 (0)	0.0 (3)	1.7 (210)	1.7 (215)	0.2 (32)	0.6 (86)	0.0 (1)	0.8 (119)	0.0 (3)	0.0 (1)	0.0 (0)	0.0 (5)	1.7 (246)	1.8 (236)
JUL	0.0 (2)	0.0 (0)	0.0 (1)	0.7 (89)	0.7 (90)	0.0 (2)	0.6 (88)	0.0 (0)	0.6 (90)	0.0 (0)	0.0 (0)	0.0 (0)	0.0 (3)	0.9 (138)	1.0 (140)
AUG	0.1 (11)	0.0 (0)	0.0 (1)	0.3 (42)	0.3 (43)	0.1 (12)	0.6 (88)	0.0 (1)	0.7 (101)	0.0 (1)	0.0 (1)	0.0 (0)	0.0 (4)	0.8 (111)	0.8 (117)
SEP	0.4 (50)	0.0 (1)	0.0 (1)	0.3 (40)	0.3 (41)	0.4 (55)	0.4 (59)	0.0 (2)	0.8 (117)	0.0 (6)	0.0 (2)	0.0 (0)	0.0 (5)	0.7 (100)	0.8 (113)
Total	23.2 (2880)	0.5 (67)	10.2 (1271)	12.2 (1513)	22.9 (2850)	22.1 (3205)	3.9 (561)	1.1 (162)	27.1 (3928)	3.5 (504)	1.1 (162)	0.2 (25)	8.8 (1279)	13.6 (1968)	27.2 (3938)

### Notes:

- (1) This includes the catchments within the Lower Gabino Sub-basin that are directly tributary to Gabino Creek. Due to the grading plans of PA7, the total tributary area increases from pre to post development conditions.
- (2) The pre-development catchments include Catchments 68, 69, 70, 71, 72, 73, 74, 75, 76, 77, 78, 79, 80.
- (3) The post-development catchments include Catchments 68, 69, 70, 71, 72, 73, 74, 75, 76, 77, 78, 79, 80, PA7-2, PA7-3, PA7-4, PA7-5, PA7-6, PA7-7, PA7-12, PA7-13, PA7-15, PA8-12 and PA8-14.
- (4) This represents runoff from the catchments that are tributary to Gabino Creek.
- (5) This represents the treated runoff diverted from Cristianitos. The watershed inches are associated with the area of Lower Gabino.
- (6) The golf course storage volume was approximated at 12 acre-ft. This exceeds the URQM sizing criteria (WEF, 1998), which was calculated to be 0.3 acre-ft.

## Blind Canyon (Alternative B-4) -Total Sub-basin<sup>1</sup>

Pre-dev area = 734 acres

Post-dev area = 1267 acres

### All Years

	Pre-Development <sup>2</sup>					Post-Development with PDEs <sup>3</sup>							
	INFLOW	OUTFLOW				INFLOW			OUTFLOW				
	Precipitation	Runoff to Blind Cyn	GW Flows	ET	Total	Precipitation	Irrigation	Total	Runoff to Blind Cyn	Stored Runoff for Irrigation <sup>4</sup>	GW Flows <sup>5</sup>	ET	Total
OCT	0.3 (20)	0.0 (1)	0.0 (0)	0.3 (20)	0.3 (20)	0.3 (33)	0.6 (61)	0.9 (94)	0.0 (1)	0.0 (1)	0.1 (11)	0.9 (97)	1.0 (109)
NOV	1.7 (105)	0.1 (4)	0.0 (3)	0.6 (37)	0.7 (44)	1.6 (169)	0.2 (26)	1.8 (195)	0.0 (4)	0.0 (4)	0.5 (52)	0.8 (86)	1.4 (147)
DEC	2.3 (138)	0.1 (6)	0.3 (16)	0.7 (42)	1.0 (64)	2.1 (223)	0.2 (19)	2.3 (242)	0.1 (8)	0.0 (4)	1.0 (101)	0.7 (77)	1.8 (191)
JAN	3.8 (233)	0.2 (12)	1.3 (77)	0.8 (49)	2.3 (138)	3.6 (375)	0.2 (16)	3.7 (391)	0.2 (21)	0.0 (5)	2.0 (208)	0.8 (85)	3.0 (318)
FEB	3.5 (215)	0.2 (11)	1.7 (101)	1.0 (63)	2.9 (175)	3.3 (347)	0.1 (13)	3.4 (359)	0.2 (21)	0.0 (4)	2.0 (215)	1.0 (103)	3.3 (344)
MAR	2.9 (179)	0.1 (8)	1.5 (90)	1.5 (93)	3.1 (191)	2.7 (288)	0.5 (50)	3.2 (338)	0.1 (12)	0.1 (13)	1.8 (191)	1.5 (153)	3.5 (369)
APR	1.2 (73)	0.0 (3)	0.3 (19)	1.9 (117)	2.3 (138)	1.1 (117)	0.9 (94)	2.0 (211)	0.0 (2)	0.1 (9)	0.6 (63)	1.8 (191)	2.5 (264)
MAY	0.4 (24)	0.0 (1)	0.1 (4)	2.0 (123)	2.1 (127)	0.4 (39)	1.1 (121)	1.5 (160)	0.0 (1)	0.0 (2)	0.2 (21)	2.0 (207)	2.2 (231)
JUN	0.1 (9)	0.0 (0)	0.0 (1)	1.4 (86)	1.4 (87)	0.1 (14)	1.4 (144)	1.5 (158)	0.0 (0)	0.0 (0)	0.1 (8)	1.8 (191)	1.9 (200)
JUL	0.0 (2)	0.0 (0)	0.0 (0)	0.3 (21)	0.4 (22)	0.0 (3)	1.4 (147)	1.4 (150)	0.0 (0)	0.0 (0)	0.0 (5)	1.5 (162)	1.6 (167)
AUG	0.1 (7)	0.0 (0)	0.0 (0)	0.1 (8)	0.1 (9)	0.1 (11)	1.4 (147)	1.5 (158)	0.0 (0)	0.0 (0)	0.1 (10)	1.4 (150)	1.5 (160)
SEP	0.4 (22)	0.0 (1)	0.0 (0)	0.2 (15)	0.3 (16)	0.3 (35)	0.9 (98)	1.3 (133)	0.0 (1)	0.0 (1)	0.2 (16)	1.2 (123)	1.3 (140)
<b>Total</b>	<b>16.8 (1026)</b>	<b>0.8 (48)</b>	<b>5.1 (311)</b>	<b>11.0 (672)</b>	<b>16.9 (1031)</b>	<b>15.7 (1654)</b>	<b>8.9 (937)</b>	<b>24.5 (2591)</b>	<b>0.7 (70)</b>	<b>0.4 (42)</b>	<b>8.5 (902)</b>	<b>15.4 (1626)</b>	<b>25.0 (2641)</b>

### Dry Period

	Pre-Development <sup>2</sup>					Post-Development with PDEs <sup>3</sup>							
	INFLOW	OUTFLOW				INFLOW			OUTFLOW				
	Precipitation	Runoff to Blind Cyn	GW Flows	ET	Total	Precipitation	Irrigation	Total	Runoff to Blind Cyn	Stored Runoff for Irrigation <sup>4</sup>	GW Flows <sup>5</sup>	ET	Total
OCT	0.3 (20)	0.0 (1)	0.0 (0)	0.4 (22)	0.4 (23)	0.3 (33)	0.6 (61)	0.9 (93)	0.0 (1)	0.0 (1)	0.1 (11)	0.9 (99)	1.1 (111)
NOV	1.9 (113)	0.1 (5)	0.1 (4)	0.6 (39)	0.8 (48)	1.7 (183)	0.2 (26)	2.0 (209)	0.0 (5)	0.0 (4)	0.5 (57)	0.8 (89)	1.5 (155)
DEC	2.4 (147)	0.1 (7)	0.2 (15)	0.7 (44)	1.1 (65)	2.2 (237)	0.2 (19)	2.4 (256)	0.1 (9)	0.0 (4)	1.0 (107)	0.7 (79)	1.9 (199)
JAN	2.8 (174)	0.1 (9)	0.6 (38)	0.8 (49)	1.6 (95)	2.6 (280)	0.2 (16)	2.8 (296)	0.1 (12)	0.0 (5)	1.3 (138)	0.8 (84)	2.3 (239)
FEB	2.5 (151)	0.1 (7)	0.9 (57)	1.0 (62)	2.1 (126)	2.3 (243)	0.1 (13)	2.4 (256)	0.1 (11)	0.0 (4)	1.3 (134)	1.0 (102)	2.4 (251)
MAR	2.0 (119)	0.1 (5)	0.7 (40)	1.5 (92)	2.2 (136)	1.8 (192)	0.5 (50)	2.3 (242)	0.0 (5)	0.1 (13)	1.0 (103)	1.4 (151)	2.6 (271)
APR	1.2 (75)	0.0 (3)	0.2 (15)	1.9 (116)	2.2 (134)	1.2 (121)	0.9 (94)	2.0 (215)	0.0 (2)	0.1 (7)	0.5 (57)	1.8 (191)	2.4 (257)
MAY	0.4 (24)	0.0 (1)	0.0 (1)	1.9 (118)	2.0 (120)	0.4 (39)	1.1 (121)	1.5 (159)	0.0 (1)	0.0 (1)	0.2 (16)	1.9 (205)	2.1 (223)
JUN	0.1 (6)	0.0 (0)	0.0 (1)	1.3 (79)	1.3 (79)	0.1 (10)	1.4 (144)	1.5 (154)	0.0 (0)	0.0 (0)	0.1 (6)	1.8 (187)	1.8 (194)
JUL	0.0 (3)	0.0 (0)	0.0 (0)	0.3 (18)	0.3 (18)	0.0 (4)	1.4 (147)	1.4 (151)	0.0 (0)	0.0 (0)	0.0 (5)	1.5 (160)	1.6 (164)
AUG	0.1 (8)	0.0 (0)	0.0 (0)	0.1 (8)	0.1 (8)	0.1 (13)	1.4 (147)	1.5 (160)	0.0 (0)	0.0 (0)	0.1 (10)	1.4 (149)	1.5 (159)
SEP	0.3 (20)	0.0 (1)	0.0 (0)	0.2 (15)	0.3 (16)	0.3 (33)	0.9 (99)	1.2 (132)	0.0 (1)	0.0 (1)	0.2 (16)	1.2 (122)	1.3 (139)
<b>Total</b>	<b>14.1 (862)</b>	<b>0.6 (37)</b>	<b>2.8 (171)</b>	<b>10.8 (662)</b>	<b>14.2 (870)</b>	<b>13.1 (1387)</b>	<b>8.9 (936)</b>	<b>22.0 (2323)</b>	<b>0.4 (45)</b>	<b>0.4 (40)</b>	<b>6.3 (661)</b>	<b>15.3 (1617)</b>	<b>22.4 (2363)</b>

### Wet Period

	Pre-Development <sup>2</sup>					Post-Development with PDEs <sup>3</sup>							
	INFLOW	OUTFLOW				INFLOW			OUTFLOW				
	Precipitation	Runoff to Blind Cyn	GW Flows	ET	Total	Precipitation	Irrigation	Total	Runoff to Blind Cyn	Stored Runoff for Irrigation <sup>4</sup>	GW Flows <sup>5</sup>	ET	Total
OCT	0.3 (20)	0.0 (1)	0.0 (0)	0.2 (14)	0.2 (15)	0.3 (32)	0.6 (61)	0.9 (94)	0.0 (1)	0.0 (1)	0.1 (9)	0.9 (94)	1.0 (104)
NOV	1.4 (87)	0.1 (3)	0.0 (0)	0.5 (31)	0.6 (35)	1.3 (140)	0.2 (26)	1.6 (167)	0.0 (4)	0.0 (3)	0.4 (42)	0.8 (81)	1.2 (130)
DEC	2.0 (120)	0.1 (6)	0.3 (17)	0.6 (38)	1.0 (61)	1.8 (194)	0.2 (19)	2.0 (213)	0.1 (8)	0.0 (4)	0.9 (90)	0.7 (74)	1.7 (175)
JAN	5.9 (358)	0.3 (20)	2.6 (160)	0.8 (49)	3.7 (228)	5.5 (578)	0.2 (16)	5.6 (594)	0.4 (38)	0.0 (5)	3.4 (357)	0.8 (86)	4.6 (486)
FEB	5.7 (351)	0.3 (20)	3.2 (195)	1.0 (63)	4.6 (278)	5.4 (566)	0.1 (13)	5.5 (578)	0.4 (42)	0.0 (4)	3.7 (387)	1.0 (106)	5.1 (540)
MAR	5.0 (304)	0.3 (16)	3.2 (197)	1.6 (95)	5.0 (307)	4.6 (491)	0.5 (49)	5.1 (539)	0.3 (27)	0.1 (14)	3.6 (379)	1.5 (157)	5.5 (577)
APR	1.1 (67)	0.0 (2)	0.5 (28)	1.9 (118)	2.4 (149)	1.0 (108)	0.9 (96)	1.9 (203)	0.0 (2)	0.1 (12)	0.7 (74)	1.8 (193)	2.7 (281)
MAY	0.4 (25)	0.0 (1)	0.1 (9)	2.2 (132)	2.3 (141)	0.4 (40)	1.2 (122)	1.5 (162)	0.0 (1)	0.0 (3)	0.3 (31)	2.0 (213)	2.3 (248)
JUN	0.2 (14)	0.0 (0)	0.0 (1)	1.7 (102)	1.7 (104)	0.2 (22)	1.4 (144)	1.6 (166)	0.0 (0)	0.0 (0)	0.1 (13)	1.9 (200)	2.0 (213)
JUL	0.0 (1)	0.0 (0)	0.0 (1)	0.5 (28)	0.5 (29)	0.0 (1)	1.4 (147)	1.4 (149)	0.0 (0)	0.0 (0)	0.1 (5)	1.6 (166)	1.6 (171)
AUG	0.1 (5)	0.0 (0)	0.0 (0)	0.1 (8)	0.1 (9)	0.1 (8)	1.4 (147)	1.5 (156)	0.0 (0)	0.0 (0)	0.1 (10)	1.4 (152)	1.5 (162)
SEP	0.4 (24)	0.0 (1)	0.0 (0)	0.2 (15)	0.3 (16)	0.4 (38)	0.9 (98)	1.3 (136)	0.0 (1)	0.0 (1)	0.1 (16)	1.2 (124)	1.3 (142)
<b>Total</b>	<b>22.5 (1375)</b>	<b>1.1 (70)</b>	<b>10.0 (609)</b>	<b>11.3 (693)</b>	<b>22.4 (1372)</b>	<b>21.0 (2218)</b>	<b>8.9 (939)</b>	<b>29.9 (3157)</b>	<b>1.2 (123)</b>	<b>0.4 (47)</b>	<b>13.4 (1412)</b>	<b>15.6 (1647)</b>	<b>30.6 (3229)</b>

#### Notes:

- (1) This includes the catchments within the Blind Canyon Sub-basin. Due to the grading plans of PA8, the total tributary area increases from pre to post development conditions.
- (2) The pre-development catchments include Catchments 64, 65, 66 and 67.
- (3) The post-development catchments include Catchments 64, 65, 66, PA8-4 through PA8-11, and PA8-13.
- (4) The storage volume was approximated at 20 acre-ft. This exceeds the URQM sizing criteria (WEF, 1998), which was calculated to be 8.1 acre-ft.
- (5) Includes GW flows from Blind Canyon, GW flows from development areas in Talega Canyon, and treated surface runoff discharged to infiltration facilities.



# Blind Canyon (Alternative B-9) -Total Sub-basin<sup>1</sup>

Pre-dev area = 734 acres

Post-dev area = 1173 acres

## All Years

	Pre-Development <sup>2</sup>					Post-Development with PDFs <sup>3</sup>								
	INFLOW	OUTFLOW				INFLOW			OUTFLOW					
	Precipitation	Runoff to Blind Cyn	GW Flows	ET	Total	Precipitation	Irrigation	Total	Runoff to Blind Cyn	Runoff to Talega Cyn	Stored Runoff for Irrigation <sup>4</sup>	GW Flows <sup>5</sup>	ET	Total
OCT	0.3 (20)	0.0 (1)	0.0 (0)	0.3 (20)	0.3 (20)	0.3 (31)	0.7 (68)	1.0 (99)	0.0 (0)	0.0 (0)	0.0 (4)	0.1 (8)	1.1 (103)	1.2 (116)
NOV	1.7 (105)	0.1 (4)	0.0 (3)	0.6 (37)	0.7 (44)	1.6 (161)	0.3 (29)	1.9 (190)	0.0 (3)	0.0 (3)	0.1 (13)	0.5 (45)	0.9 (84)	1.5 (148)
DEC	2.3 (138)	0.1 (6)	0.3 (16)	0.7 (42)	1.0 (64)	2.2 (212)	0.2 (21)	2.4 (233)	0.1 (5)	0.1 (5)	0.1 (13)	1.0 (100)	0.7 (70)	2.0 (194)
JAN	3.8 (233)	0.2 (12)	1.3 (77)	0.8 (49)	2.3 (138)	3.7 (357)	0.2 (18)	3.8 (375)	0.1 (12)	0.1 (10)	0.1 (13)	2.0 (195)	0.8 (76)	3.1 (307)
FEB	3.5 (215)	0.2 (11)	1.7 (101)	1.0 (63)	2.9 (175)	3.4 (330)	0.1 (14)	3.5 (344)	0.1 (11)	0.1 (10)	0.1 (11)	2.0 (198)	0.9 (91)	3.3 (321)
MAR	2.9 (179)	0.1 (8)	1.5 (90)	1.5 (93)	3.1 (191)	2.8 (274)	0.6 (56)	3.4 (330)	0.1 (7)	0.1 (6)	0.2 (19)	1.7 (171)	1.4 (135)	3.5 (338)
APR	1.2 (73)	0.0 (3)	0.3 (19)	1.9 (117)	2.3 (138)	1.1 (111)	1.1 (107)	2.2 (218)	0.0 (1)	0.0 (1)	0.2 (17)	0.6 (56)	1.7 (169)	2.5 (244)
MAY	0.4 (24)	0.0 (1)	0.1 (4)	2.0 (123)	2.1 (127)	0.4 (37)	1.4 (137)	1.8 (174)	0.0 (0)	0.0 (0)	0.1 (10)	0.2 (20)	1.9 (189)	2.3 (220)
JUN	0.1 (9)	0.0 (0)	0.0 (1)	1.4 (86)	1.4 (87)	0.1 (13)	1.7 (163)	1.8 (176)	0.0 (0)	0.0 (0)	0.0 (2)	0.1 (9)	2.0 (192)	2.1 (203)
JUL	0.0 (2)	0.0 (0)	0.0 (0)	0.3 (21)	0.4 (22)	0.0 (3)	1.7 (166)	1.7 (169)	0.0 (0)	0.0 (0)	0.0 (0)	0.1 (6)	1.8 (180)	1.9 (186)
AUG	0.1 (7)	0.0 (0)	0.0 (0)	0.1 (8)	0.1 (9)	0.1 (11)	1.6 (153)	1.7 (164)	0.0 (0)	0.0 (0)	0.0 (1)	0.1 (8)	1.6 (157)	1.7 (166)
SEP	0.4 (22)	0.0 (1)	0.0 (0)	0.2 (15)	0.3 (16)	0.3 (33)	1.1 (110)	1.5 (143)	0.0 (0)	0.0 (0)	0.0 (3)	0.1 (12)	1.3 (131)	1.5 (147)
Total	16.8 (1026)	0.8 (48)	5.1 (311)	11.0 (672)	16.9 (1031)	16.1 (1573)	10.7 (1042)	26.8 (2616)	0.4 (41)	0.4 (36)	1.1 (106)	8.5 (829)	16.1 (1577)	26.5 (2589)

## Dry Period

	Pre-Development <sup>2</sup>					Post-Development with PDFs <sup>3</sup>								
	INFLOW	OUTFLOW				INFLOW			OUTFLOW					
	Precipitation	Runoff to Blind Cyn	GW Flows	ET	Total	Precipitation	Irrigation	Total	Runoff to Blind Cyn	Runoff to Talega Cyn	Stored Runoff for Irrigation <sup>4</sup>	GW Flows <sup>5</sup>	ET	Total
OCT	0.3 (20)	0.0 (1)	0.0 (0)	0.4 (22)	0.4 (23)	0.3 (31)	0.7 (68)	1.0 (99)	0.0 (0)	0.0 (0)	0.0 (4)	0.1 (9)	1.1 (104)	1.2 (118)
NOV	1.9 (113)	0.1 (5)	0.1 (4)	0.6 (39)	0.8 (48)	1.8 (174)	0.3 (29)	2.1 (203)	0.0 (3)	0.0 (3)	0.1 (14)	0.5 (48)	0.9 (86)	1.6 (155)
DEC	2.4 (147)	0.1 (7)	0.2 (15)	0.7 (44)	1.1 (65)	2.3 (225)	0.2 (21)	2.5 (246)	0.1 (6)	0.1 (6)	0.1 (13)	1.1 (106)	0.7 (72)	2.1 (202)
JAN	2.8 (174)	0.1 (9)	0.6 (38)	0.8 (49)	1.6 (95)	2.7 (266)	0.2 (18)	2.9 (284)	0.1 (8)	0.1 (7)	0.1 (13)	1.4 (134)	0.8 (75)	2.4 (236)
FEB	2.5 (151)	0.1 (7)	0.9 (57)	1.0 (62)	2.1 (126)	2.4 (232)	0.1 (14)	2.5 (246)	0.1 (6)	0.1 (5)	0.1 (11)	1.3 (125)	0.9 (90)	2.4 (237)
MAR	2.0 (119)	0.1 (5)	0.7 (40)	1.5 (92)	2.2 (136)	1.9 (183)	0.6 (57)	2.5 (240)	0.0 (3)	0.0 (2)	0.2 (19)	0.9 (92)	1.4 (133)	2.5 (249)
APR	1.2 (75)	0.0 (3)	0.2 (15)	1.9 (116)	2.2 (134)	1.2 (116)	1.1 (106)	2.3 (222)	0.0 (1)	0.0 (1)	0.2 (16)	0.5 (53)	1.7 (169)	2.5 (240)
MAY	0.4 (24)	0.0 (1)	0.0 (1)	1.9 (118)	2.0 (120)	0.4 (37)	1.4 (136)	1.8 (173)	0.0 (0)	0.0 (0)	0.1 (10)	0.2 (16)	1.9 (189)	2.2 (216)
JUN	0.1 (6)	0.0 (0)	0.0 (1)	1.3 (79)	1.3 (79)	0.1 (9)	1.7 (163)	1.8 (172)	0.0 (0)	0.0 (0)	0.0 (1)	0.1 (8)	1.9 (190)	2.0 (199)
JUL	0.0 (3)	0.0 (0)	0.0 (0)	0.3 (18)	0.3 (18)	0.0 (4)	1.7 (166)	1.7 (170)	0.0 (0)	0.0 (0)	0.0 (0)	0.1 (6)	1.8 (177)	1.9 (184)
AUG	0.1 (8)	0.0 (0)	0.0 (0)	0.1 (8)	0.1 (8)	0.1 (8)	1.6 (153)	1.7 (165)	0.0 (0)	0.0 (0)	0.0 (1)	0.1 (8)	1.6 (157)	1.7 (166)
SEP	0.3 (20)	0.0 (1)	0.0 (0)	0.2 (15)	0.3 (16)	0.3 (31)	1.1 (110)	1.5 (142)	0.0 (0)	0.0 (0)	0.0 (3)	0.1 (12)	1.3 (131)	1.5 (147)
Total	14.1 (862)	0.6 (37)	2.8 (171)	10.8 (662)	14.2 (870)	13.5 (1320)	10.7 (1041)	24.2 (2362)	0.3 (27)	0.3 (26)	1.1 (105)	6.3 (618)	16.1 (1572)	24.0 (2349)

## Wet Period

	Pre-Development <sup>2</sup>					Post-Development with PDFs <sup>3</sup>								
	INFLOW	OUTFLOW				INFLOW			OUTFLOW					
	Precipitation	Runoff to Blind Cyn	GW Flows	ET	Total	Precipitation	Irrigation	Total	Runoff to Blind Cyn	Runoff to Talega Cyn	Stored Runoff for Irrigation <sup>4</sup>	GW Flows <sup>5</sup>	ET	Total
OCT	0.3 (20)	0.0 (1)	0.0 (0)	0.2 (14)	0.2 (15)	0.3 (31)	0.7 (68)	1.0 (99)	0.0 (0)	0.0 (0)	0.0 (3)	0.1 (6)	1.0 (101)	1.1 (111)
NOV	1.4 (87)	0.1 (3)	0.0 (0)	0.5 (31)	0.6 (35)	1.4 (133)	0.3 (30)	1.7 (163)	0.0 (3)	0.0 (2)	0.1 (10)	0.4 (37)	0.8 (81)	1.4 (133)
DEC	2.0 (120)	0.1 (6)	0.3 (17)	0.6 (38)	1.0 (61)	1.9 (185)	0.2 (21)	2.1 (206)	0.0 (5)	0.0 (4)	0.1 (12)	0.9 (86)	0.7 (68)	1.8 (176)
JAN	5.9 (358)	0.3 (20)	2.6 (160)	0.8 (49)	3.7 (228)	5.6 (549)	0.2 (18)	5.8 (567)	0.2 (21)	0.2 (18)	0.1 (14)	3.3 (326)	0.8 (78)	4.7 (456)
FEB	5.7 (351)	0.3 (20)	3.2 (195)	1.0 (63)	4.6 (278)	5.5 (538)	0.1 (14)	5.7 (552)	0.2 (22)	0.2 (19)	0.1 (11)	3.6 (352)	1.0 (94)	5.1 (499)
MAR	5.0 (304)	0.3 (16)	3.2 (197)	1.6 (95)	5.0 (307)	4.8 (467)	0.6 (55)	5.3 (522)	0.2 (17)	0.1 (14)	0.2 (20)	3.4 (337)	1.4 (138)	5.4 (526)
APR	1.1 (67)	0.0 (2)	0.5 (28)	1.9 (118)	2.4 (149)	1.0 (102)	1.1 (108)	2.2 (211)	0.0 (1)	0.0 (1)	0.2 (19)	0.7 (64)	1.7 (168)	2.6 (252)
MAY	0.4 (25)	0.0 (1)	0.1 (9)	2.2 (132)	2.3 (141)	0.4 (38)	1.4 (138)	1.8 (176)	0.0 (1)	0.0 (0)	0.1 (9)	0.3 (29)	1.9 (190)	2.3 (229)
JUN	0.2 (14)	0.0 (0)	0.0 (1)	1.7 (102)	1.7 (104)	0.2 (21)	1.7 (163)	1.9 (184)	0.0 (0)	0.0 (0)	0.0 (4)	0.1 (13)	2.0 (196)	2.2 (213)
JUL	0.0 (1)	0.0 (0)	0.0 (1)	0.5 (28)	0.5 (29)	0.0 (1)	1.7 (166)	1.7 (167)	0.0 (0)	0.0 (0)	0.0 (0)	0.1 (7)	1.9 (184)	2.0 (191)
AUG	0.1 (5)	0.0 (0)	0.0 (0)	0.1 (8)	0.1 (9)	0.1 (8)	1.6 (153)	1.6 (161)	0.0 (0)	0.0 (0)	0.0 (1)	0.1 (7)	1.6 (158)	1.7 (166)
SEP	0.4 (24)	0.0 (1)	0.0 (0)	0.2 (15)	0.3 (16)	0.4 (36)	1.1 (110)	1.5 (146)	0.0 (0)	0.0 (0)	0.0 (4)	0.1 (11)	1.3 (131)	1.5 (147)
Total	22.5 (1375)	1.1 (70)	10.0 (609)	11.3 (693)	22.4 (1372)	21.6 (2110)	10.7 (1045)	32.3 (3155)	0.7 (71)	0.6 (59)	1.1 (107)	13.0 (1275)	16.2 (1587)	31.7 (3099)

### Notes:

- (1) This includes the catchments within the Blind Canyon Sub-basin. Due to the grading plans of PA8, the total tributary area increases from pre to post development conditions.
- (2) The pre-development catchments include Catchments 64, 65, 66 and 67.
- (3) The post-development catchments include Catchments 64, 65, 66, 67 and T-1.
- (4) The storage volume was approximated at 20 acre-ft. This exceeds the URQM sizing criteria (WEF, 1998), which was calculated to be 8.1 acre-ft.
- (5) Includes GW flows from Blind Canyon, GW flows from development areas in Talega Canyon, and discharges to infiltration facilities.

## Talega (Alternative B-4) - Total Sub-basin<sup>1</sup>

Pre-dev area = 473 acres<sup>2</sup>

Post-dev area = ~0 acres<sup>3</sup>

### All Years

	Pre-Development <sup>2</sup>					Post-Development with PDFs <sup>3</sup>				
	INFLOW	OUTFLOW				INFLOW			OUTFLOW	
	Precipitation	Runoff to Talega Crk <sup>4</sup>	GW Outflow <sup>5</sup>	ET	Total	Precipitation	Irrigation	Total	Runoff to Talega Crk <sup>6</sup>	Total
OCT	0.3 (12)	0.0 (1)	0.0 (0)	0.3 (11)	0.3 (11)	0.3 (16)	0.7 (35)	0.9 (50)	0.0 (0)	0.0 (0)
NOV	1.5 (60)	0.1 (4)	0.0 (1)	0.5 (19)	0.6 (24)	1.5 (82)	0.3 (15)	1.8 (96)	0.0 (2)	0.0 (2)
DEC	2.0 (79)	0.1 (5)	0.2 (7)	0.5 (21)	0.8 (33)	2.0 (108)	0.2 (11)	2.2 (119)	0.1 (4)	0.1 (4)
JAN	3.4 (133)	0.2 (8)	1.0 (40)	0.6 (25)	1.8 (73)	3.4 (182)	0.2 (9)	3.6 (190)	0.1 (7)	0.1 (7)
FEB	3.1 (123)	0.2 (7)	1.4 (57)	0.8 (31)	2.4 (95)	3.2 (168)	0.1 (7)	3.3 (175)	0.1 (7)	0.1 (7)
MAR	2.6 (102)	0.2 (6)	1.3 (52)	1.2 (46)	2.6 (104)	2.6 (139)	0.5 (27)	3.1 (166)	0.1 (4)	0.1 (4)
APR	1.1 (41)	0.1 (2)	0.3 (12)	1.5 (58)	1.8 (71)	1.1 (57)	1.0 (51)	2.0 (108)	0.0 (1)	0.0 (1)
MAY	0.4 (14)	0.0 (1)	0.1 (3)	1.6 (65)	1.7 (68)	0.4 (19)	1.2 (66)	1.6 (85)	0.0 (0)	0.0 (0)
JUN	0.1 (5)	0.0 (0)	0.0 (0)	1.6 (61)	1.6 (62)	0.1 (7)	1.5 (79)	1.6 (86)	0.0 (0)	0.0 (0)
JUL	0.0 (1)	0.0 (0)	0.0 (0)	0.8 (33)	0.8 (33)	0.0 (2)	1.5 (81)	1.6 (83)	0.0 (0)	0.0 (0)
AUG	0.1 (4)	0.0 (0)	0.0 (0)	0.1 (5)	0.1 (6)	0.1 (5)	1.5 (81)	1.6 (87)	0.0 (0)	0.0 (0)
SEP	0.3 (12)	0.0 (1)	0.0 (0)	0.2 (8)	0.2 (9)	0.3 (17)	1.0 (55)	1.4 (72)	0.0 (0)	0.0 (0)
<b>Total</b>	<b>14.9 (586)</b>	<b>0.9 (35)</b>	<b>4.4 (172)</b>	<b>9.7 (383)</b>	<b>14.9 (589)</b>	<b>15.1 (801)</b>	<b>9.7 (517)</b>	<b>24.8 (1317)</b>	<b>0.5 (25)</b>	<b>0.5 (25)</b>

### Dry Period

	Pre-Development <sup>2</sup>					Post-Development with PDFs <sup>3</sup>				
	INFLOW	OUTFLOW				INFLOW			OUTFLOW	
	Precipitation	Runoff to Talega Crk <sup>4</sup>	GW Outflow <sup>5</sup>	ET	Total	Precipitation	Irrigation	Total	Runoff to Talega Crk <sup>6</sup>	Total
OCT	0.3 (12)	0.0 (1)	0.0 (0)	0.3 (12)	0.3 (13)	0.3 (16)	0.6 (34)	0.9 (50)	0.0 (0)	0.0 (0)
NOV	1.6 (65)	0.1 (4)	0.0 (2)	0.5 (20)	0.7 (26)	1.7 (88)	0.3 (14)	1.9 (103)	0.0 (2)	0.0 (2)
DEC	2.1 (84)	0.1 (5)	0.2 (7)	0.6 (22)	0.9 (34)	2.2 (115)	0.2 (11)	2.4 (125)	0.1 (4)	0.1 (4)
JAN	2.5 (99)	0.2 (6)	0.5 (18)	0.6 (25)	1.2 (49)	2.5 (135)	0.2 (9)	2.7 (144)	0.1 (5)	0.1 (5)
FEB	2.2 (86)	0.1 (5)	0.8 (31)	0.8 (31)	1.7 (67)	2.2 (118)	0.1 (7)	2.3 (125)	0.1 (4)	0.1 (4)
MAR	1.7 (68)	0.1 (4)	0.6 (23)	1.2 (45)	1.8 (72)	1.8 (93)	0.5 (27)	2.3 (120)	0.0 (2)	0.0 (2)
APR	1.1 (43)	0.1 (2)	0.2 (9)	1.5 (58)	1.7 (69)	1.1 (59)	1.0 (51)	2.1 (110)	0.0 (1)	0.0 (1)
MAY	0.3 (14)	0.0 (1)	0.0 (1)	1.6 (65)	1.7 (66)	0.4 (19)	1.2 (66)	1.6 (85)	0.0 (0)	0.0 (0)
JUN	0.1 (4)	0.0 (0)	0.0 (0)	1.5 (59)	1.5 (59)	0.1 (5)	1.5 (79)	1.6 (84)	0.0 (0)	0.0 (0)
JUL	0.0 (1)	0.0 (0)	0.0 (0)	0.7 (28)	0.7 (28)	0.0 (2)	1.5 (81)	1.6 (83)	0.0 (0)	0.0 (0)
AUG	0.1 (5)	0.0 (0)	0.0 (0)	0.1 (4)	0.1 (4)	0.1 (6)	1.5 (81)	1.6 (87)	0.0 (0)	0.0 (0)
SEP	0.3 (12)	0.0 (1)	0.0 (0)	0.2 (8)	0.2 (9)	0.3 (16)	1.0 (55)	1.3 (71)	0.0 (0)	0.0 (0)
<b>Total</b>	<b>12.5 (491)</b>	<b>0.7 (28)</b>	<b>2.3 (91)</b>	<b>9.5 (376)</b>	<b>12.6 (496)</b>	<b>12.6 (671)</b>	<b>9.7 (516)</b>	<b>22.3 (1187)</b>	<b>0.3 (18)</b>	<b>0.3 (18)</b>

### Wet Period

	Pre-Development <sup>2</sup>					Post-Development with PDFs <sup>3</sup>				
	INFLOW	OUTFLOW				INFLOW			OUTFLOW	
	Precipitation	Runoff to Talega Crk <sup>4</sup>	GW Outflow <sup>5</sup>	ET	Total	Precipitation	Irrigation	Total	Runoff to Talega Crk <sup>6</sup>	Total
OCT	0.3 (12)	0.0 (1)	0.0 (0)	0.2 (8)	0.2 (9)	0.3 (16)	0.7 (35)	0.9 (50)	0.0 (0)	0.0 (0)
NOV	1.3 (50)	0.1 (3)	0.0 (0)	0.4 (16)	0.5 (19)	1.3 (68)	0.3 (15)	1.6 (83)	0.0 (2)	0.0 (2)
DEC	1.8 (69)	0.1 (4)	0.2 (8)	0.5 (19)	0.8 (31)	1.8 (94)	0.2 (11)	2.0 (105)	0.1 (3)	0.1 (3)
JAN	5.2 (205)	0.3 (13)	2.2 (86)	0.6 (25)	3.1 (124)	5.3 (280)	0.2 (9)	5.4 (289)	0.2 (12)	0.2 (12)
FEB	5.1 (201)	0.3 (12)	2.8 (110)	0.8 (32)	3.9 (154)	5.2 (274)	0.1 (7)	5.3 (281)	0.3 (14)	0.3 (14)
MAR	4.4 (174)	0.3 (10)	2.9 (113)	1.2 (47)	4.3 (170)	4.5 (238)	0.5 (26)	5.0 (264)	0.2 (10)	0.2 (10)
APR	1.0 (38)	0.1 (2)	0.4 (17)	1.4 (57)	1.9 (77)	1.0 (52)	1.0 (52)	2.0 (104)	0.0 (0)	0.0 (0)
MAY	0.4 (14)	0.0 (1)	0.2 (6)	1.7 (65)	1.8 (72)	0.4 (19)	1.3 (67)	1.6 (86)	0.0 (0)	0.0 (0)
JUN	0.2 (8)	0.0 (0)	0.0 (1)	1.7 (67)	1.7 (68)	0.2 (11)	1.5 (79)	1.7 (90)	0.0 (0)	0.0 (0)
JUL	0.0 (0)	0.0 (0)	0.0 (0)	1.1 (44)	1.1 (44)	0.0 (1)	1.5 (81)	1.5 (82)	0.0 (0)	0.0 (0)
AUG	0.1 (3)	0.0 (0)	0.0 (0)	0.2 (7)	0.2 (8)	0.1 (4)	1.5 (81)	1.6 (85)	0.0 (0)	0.0 (0)
SEP	0.3 (14)	0.0 (1)	0.0 (0)	0.2 (8)	0.2 (9)	0.3 (19)	1.0 (55)	1.4 (73)	0.0 (0)	0.0 (0)
<b>Total</b>	<b>20.0 (788)</b>	<b>1.2 (47)</b>	<b>8.7 (343)</b>	<b>10.0 (396)</b>	<b>19.9 (786)</b>	<b>20.2 (1075)</b>	<b>9.7 (518)</b>	<b>30.0 (1593)</b>	<b>0.8 (42)</b>	<b>0.8 (42)</b>

#### Notes:

- (1) This includes the catchments that are impacted by the development of PA8 south of Blind Canyon Creek. Due to the grading plan of PA8, the area tributary of Talega Creek will decrease from 5376 acres in the pre-development conditions to 4898 acres in the post-development conditions.

- (2) For pre-development conditions, the area of 473 acres represents only that area which drains to Talega Canyon such as Catchments 3, 4, 5, 6, 7, 8, 9a, and 9b.
- (3) For post-development conditions, the graded area all drains to a common collection point. The majority of runoff from this area is diverted to Blind Canyon.
- (4) Because only the development areas are modeled, runoff may not represent actual volumes that reach the stream. Surface runoff could infiltrate in open space areas between the development area and the stream.
- (5) Because only the development areas are modeled, GW flows may not represent actual volumes that reach the stream. Some GW flows could be lost to ET, or GW flows could be greater if there is significant infiltration in the open space areas.
- (6) Assumes that all flows from the development Catchments PA8-3, PA8-4, PA8-5, PA8-6, PA8-7, PA8-8, and PA8-9 are collected in a pipe. There would be a flow duration basin that would divert a portion of the flows to Talega Creek (via a swale), while excess flows would be diverted to a detention basin located in Blind Canyon. All flows diverted to Blind Canyon would be treated in the detention basin. Effluent discharge from the detention basin would be routed to an infiltration basin located near the confluence of Gabino and Blind Creeks.

## Talega (Alternative B-9) - Total Sub-basin<sup>1</sup>

Pre-dev area = 473 acres<sup>2</sup>

Post-dev area = ~0 acres<sup>3</sup>

### All Years

	Pre-Development <sup>2</sup>					Post-Development with PDFs <sup>3</sup>				
	INFLOW	OUTFLOW				INFLOW			OUTFLOW	
	Precipitation	Runoff to Telega Crk <sup>4</sup>	GW Outflow <sup>5</sup>	ET	Total	Precipitation	Irrigation	Total	Runoff to Telega Crk <sup>4</sup>	Total
OCT	0.3 (10)	0.0 (1)	0.0 (0)	0.3 (9)	0.3 (10)	0.3 (10)	0.4 (15)	0.7 (25)	0.0 (0)	0.0 (0)
NOV	1.5 (54)	0.1 (4)	0.0 (1)	0.5 (17)	0.6 (22)	1.5 (54)	0.2 (6)	1.7 (60)	0.1 (3)	0.1 (3)
DEC	2.0 (71)	0.1 (5)	0.2 (6)	0.5 (19)	0.9 (30)	2.0 (71)	0.1 (5)	2.1 (75)	0.1 (5)	0.1 (5)
JAN	3.4 (119)	0.2 (9)	1.0 (35)	0.6 (22)	1.9 (66)	3.4 (119)	0.1 (4)	3.5 (123)	0.3 (10)	0.3 (10)
FEB	3.1 (110)	0.2 (8)	1.4 (51)	0.8 (28)	2.4 (86)	3.1 (110)	0.1 (3)	3.2 (113)	0.3 (10)	0.3 (10)
MAR	2.6 (92)	0.2 (6)	1.3 (46)	1.2 (41)	2.6 (93)	2.6 (91)	0.3 (12)	2.9 (103)	0.2 (6)	0.2 (6)
APR	1.1 (37)	0.1 (2)	0.3 (10)	1.4 (51)	1.8 (64)	1.1 (37)	0.6 (22)	1.7 (59)	0.0 (1)	0.0 (1)
MAY	0.4 (12)	0.0 (1)	0.1 (2)	1.6 (57)	1.7 (60)	0.4 (12)	0.8 (28)	1.2 (41)	0.0 (0)	0.0 (0)
JUN	0.1 (4)	0.0 (0)	0.0 (0)	1.5 (55)	1.6 (55)	0.1 (4)	1.0 (34)	1.1 (38)	0.0 (0)	0.0 (0)
JUL	0.0 (1)	0.0 (0)	0.0 (0)	0.8 (30)	0.9 (30)	0.0 (1)	1.0 (35)	1.0 (36)	0.0 (0)	0.0 (0)
AUG	0.1 (4)	0.0 (0)	0.0 (0)	0.1 (4)	0.1 (5)	0.1 (4)	0.9 (33)	1.0 (36)	0.0 (0)	0.0 (0)
SEP	0.3 (11)	0.0 (1)	0.0 (0)	0.2 (7)	0.2 (8)	0.3 (11)	0.7 (24)	1.0 (35)	0.0 (0)	0.0 (0)
<b>Total</b>	<b>14.9 (526)</b>	<b>1.0 (36)</b>	<b>4.3 (153)</b>	<b>9.6 (340)</b>	<b>15.0 (529)</b>	<b>14.9 (525)</b>	<b>6.3 (220)</b>	<b>21.2 (745)</b>	<b>1.0 (36)</b>	<b>1.0 (36)</b>

### Dry Period

	Pre-Development <sup>2</sup>					Post-Development with PDFs <sup>3</sup>				
	INFLOW	OUTFLOW				INFLOW			OUTFLOW	
	Precipitation	Runoff to Telega Crk <sup>4</sup>	GW Outflow <sup>5</sup>	ET	Total	Precipitation	Irrigation	Total	Runoff to Telega Crk <sup>4</sup>	Total
OCT	0.3 (10)	0.0 (1)	0.0 (0)	0.3 (11)	0.3 (11)	0.3 (10)	0.4 (15)	0.7 (25)	0.0 (0)	0.0 (0)
NOV	1.6 (58)	0.1 (4)	0.0 (1)	0.5 (18)	0.7 (24)	1.6 (58)	0.2 (6)	1.8 (64)	0.1 (3)	0.1 (3)
DEC	2.1 (75)	0.2 (5)	0.2 (6)	0.6 (20)	0.9 (31)	2.1 (75)	0.1 (5)	2.3 (80)	0.2 (6)	0.2 (6)
JAN	2.5 (89)	0.2 (6)	0.4 (16)	0.6 (22)	1.2 (44)	2.5 (89)	0.1 (4)	2.6 (92)	0.2 (7)	0.2 (7)
FEB	2.2 (77)	0.2 (5)	0.8 (28)	0.8 (27)	1.7 (61)	2.2 (77)	0.1 (3)	2.3 (80)	0.2 (5)	0.2 (5)
MAR	1.7 (61)	0.1 (4)	0.6 (21)	1.1 (40)	1.8 (65)	1.7 (61)	0.3 (12)	2.1 (73)	0.1 (2)	0.1 (2)
APR	1.1 (39)	0.1 (2)	0.2 (8)	1.4 (51)	1.7 (61)	1.1 (38)	0.6 (22)	1.7 (60)	0.0 (1)	0.0 (1)
MAY	0.3 (12)	0.0 (1)	0.0 (1)	1.6 (57)	1.7 (59)	0.3 (12)	0.8 (28)	1.2 (41)	0.0 (0)	0.0 (0)
JUN	0.1 (3)	0.0 (0)	0.0 (0)	1.5 (52)	1.5 (53)	0.1 (3)	1.0 (34)	1.1 (37)	0.0 (0)	0.0 (0)
JUL	0.0 (1)	0.0 (0)	0.0 (0)	0.7 (26)	0.7 (26)	0.0 (1)	1.0 (35)	1.0 (36)	0.0 (0)	0.0 (0)
AUG	0.1 (4)	0.0 (0)	0.0 (0)	0.1 (3)	0.1 (4)	0.1 (4)	0.9 (33)	1.0 (37)	0.0 (0)	0.0 (0)
SEP	0.3 (10)	0.0 (1)	0.0 (0)	0.2 (7)	0.2 (8)	0.3 (10)	0.7 (24)	1.0 (34)	0.0 (0)	0.0 (0)
<b>Total</b>	<b>12.5 (441)</b>	<b>0.8 (30)</b>	<b>2.3 (81)</b>	<b>9.5 (334)</b>	<b>12.6 (445)</b>	<b>12.5 (440)</b>	<b>6.2 (220)</b>	<b>18.8 (660)</b>	<b>0.7 (26)</b>	<b>0.7 (26)</b>

### Wet Period

	Pre-Development <sup>2</sup>					Post-Development with PDFs <sup>3</sup>				
	INFLOW	OUTFLOW				INFLOW			OUTFLOW	
	Precipitation	Runoff to Telega Crk <sup>4</sup>	GW Outflow <sup>5</sup>	ET	Total	Precipitation	Irrigation	Total	Runoff to Telega Crk <sup>4</sup>	Total
OCT	0.3 (10)	0.0 (1)	0.0 (0)	0.2 (7)	0.2 (8)	0.3 (10)	0.4 (15)	0.7 (25)	0.0 (0)	0.0 (0)
NOV	1.3 (45)	0.1 (3)	0.0 (0)	0.4 (14)	0.5 (17)	1.3 (45)	0.2 (6)	1.5 (51)	0.1 (2)	0.1 (2)
DEC	1.8 (62)	0.1 (4)	0.2 (7)	0.5 (17)	0.8 (29)	1.8 (62)	0.1 (5)	1.9 (67)	0.1 (4)	0.1 (4)
JAN	5.2 (184)	0.4 (13)	2.2 (77)	0.6 (22)	3.2 (112)	5.2 (183)	0.1 (4)	5.3 (187)	0.5 (18)	0.5 (18)
FEB	5.1 (180)	0.4 (13)	2.8 (98)	0.8 (28)	3.9 (139)	5.1 (180)	0.1 (3)	5.2 (183)	0.5 (19)	0.5 (19)
MAR	4.4 (156)	0.3 (11)	2.9 (101)	1.2 (42)	4.4 (153)	4.4 (156)	0.3 (11)	4.8 (167)	0.4 (14)	0.4 (14)
APR	1.0 (34)	0.1 (2)	0.4 (16)	1.4 (51)	1.9 (68)	1.0 (34)	0.6 (22)	1.6 (57)	0.0 (1)	0.0 (1)
MAY	0.4 (13)	0.0 (1)	0.2 (5)	1.6 (58)	1.8 (64)	0.4 (13)	0.8 (29)	1.2 (41)	0.0 (0)	0.0 (0)
JUN	0.2 (7)	0.0 (0)	0.0 (1)	1.7 (59)	1.7 (61)	0.2 (7)	1.0 (34)	1.2 (41)	0.0 (0)	0.0 (0)
JUL	0.0 (0)	0.0 (0)	0.0 (0)	1.1 (39)	1.1 (39)	0.0 (0)	1.0 (35)	1.0 (35)	0.0 (0)	0.0 (0)
AUG	0.1 (3)	0.0 (0)	0.0 (0)	0.2 (6)	0.2 (6)	0.1 (3)	0.9 (33)	1.0 (35)	0.0 (0)	0.0 (0)
SEP	0.3 (12)	0.0 (1)	0.0 (0)	0.2 (7)	0.2 (8)	0.3 (12)	0.7 (24)	1.0 (36)	0.0 (0)	0.0 (0)
<b>Total</b>	<b>20.1 (707)</b>	<b>1.4 (50)</b>	<b>8.7 (305)</b>	<b>9.9 (350)</b>	<b>20.0 (705)</b>	<b>20.1 (705)</b>	<b>6.3 (220)</b>	<b>26.3 (925)</b>	<b>1.7 (59)</b>	<b>1.7 (59)</b>

#### Notes:

- (1) This includes the catchments that are impacted by the development of PA8 south of Blind Canyon Creek. Due to the grading plan of PA8, the area tributary of Talega Creek will decrease from 5376 acres in the pre-development conditions to 4898 acres in the post-development conditions.

- (2) For pre-development conditions, the area of 473 acres represents only that area which drains to Talega Canyon.
- (3) Because there was no grading plan available for B9, it is assumed that all runoff generated from the developed portions of the Talega Sub-basin is diverted to Blind Canyon.
- (4) Because only the development areas are modeled, runoff may not represent actual volumes that reach the stream. Surface runoff could infiltrate in open space areas between the development area and the stream.
- (5) Because only the development areas are modeled, GW flows may not represent actual volumes that reach the stream. Some GW flows could be lost to ET, or GW flows could be greater if there is significant infiltration in the open space areas.
- (6) Assumes that all flows from the development Catchment T-1 are collected in a pipe. There would be a flow duration basin that would divert a portion of the flows to Talega Creek (via a swale), while excess flows would be diverted to an infiltration basin located in Blind Canyon. A portion of the flows generated from Catchments 64, 65, 66 and 67 would be used to match flow duration in Blind Creek while excess flow would be diverted to an infiltration basin located in Blind Canyon. Effluent discharge from the detention basin would be routed to an infiltration basin located near the confluence of Gabino and Blind Creeks.

# Verdugo (Alternative B-9)<sup>1</sup>

Pre-dev area = 1514 acres

Post-dev area = 1576 acres

## All Years

	Pre-Development <sup>2</sup>					Post-Development with PDFs <sup>3</sup>						
	INFLOW	OUTFLOW				INFLOW			OUTFLOW			
	Precipitation	Runoff to Verdugo Cyn	GW Outflow	ET	Total	Precipitation	Irrigation	Total	Runoff to Verdugo Cyn	GW Outflow	ET	Total
OCT	0.3 (43)	0.0 (0)	0.2 (26)	0.3 (41)	0.5 (66)	0.3 (45)	0.5 (66)	0.8 (110)	0.0 (0)	0.7 (87)	0.5 (67)	1.2 (155)
NOV	1.8 (222)	0.0 (0)	0.2 (22)	0.5 (69)	0.7 (92)	1.8 (232)	0.2 (28)	2.0 (259)	0.0 (0)	0.7 (88)	0.6 (78)	1.3 (166)
DEC	2.3 (293)	0.0 (0)	0.3 (38)	0.6 (81)	0.9 (118)	2.3 (306)	0.2 (20)	2.5 (327)	0.0 (0)	0.9 (116)	0.6 (81)	1.5 (197)
JAN	3.9 (493)	0.0 (4)	0.8 (97)	0.7 (90)	1.5 (191)	3.9 (515)	0.1 (17)	4.1 (532)	0.0 (6)	1.4 (185)	0.7 (88)	2.1 (280)
FEB	3.6 (456)	0.1 (18)	1.3 (164)	0.9 (115)	2.4 (297)	3.6 (476)	0.1 (13)	3.7 (489)	0.1 (19)	1.8 (237)	0.8 (111)	2.8 (367)
MAR	3.0 (378)	0.0 (5)	1.8 (224)	1.4 (172)	3.2 (401)	3.0 (395)	0.4 (51)	3.4 (446)	0.0 (5)	2.3 (296)	1.3 (165)	3.5 (466)
APR	1.2 (154)	0.0 (1)	1.2 (151)	1.7 (219)	2.9 (371)	1.2 (160)	0.7 (97)	2.0 (258)	0.0 (1)	1.6 (206)	1.6 (210)	3.2 (417)
MAY	0.4 (51)	0.0 (0)	0.8 (95)	1.7 (213)	2.4 (309)	0.4 (53)	1.0 (126)	1.4 (179)	0.0 (0)	1.2 (152)	1.6 (212)	2.8 (365)
JUN	0.1 (18)	0.0 (0)	0.5 (63)	0.8 (95)	1.3 (159)	0.1 (19)	1.1 (150)	1.3 (169)	0.0 (0)	1.0 (128)	1.0 (133)	2.0 (261)
JUL	0.0 (4)	0.0 (0)	0.4 (49)	0.1 (9)	0.5 (58)	0.0 (4)	1.2 (155)	1.2 (159)	0.0 (0)	0.9 (125)	0.5 (71)	1.5 (196)
AUG	0.1 (15)	0.0 (0)	0.3 (38)	0.1 (12)	0.4 (50)	0.1 (15)	1.1 (144)	1.2 (160)	0.0 (0)	0.9 (119)	0.5 (69)	1.4 (188)
SEP	0.4 (46)	0.0 (0)	0.2 (30)	0.2 (30)	0.5 (60)	0.4 (48)	0.8 (105)	1.2 (152)	0.0 (0)	0.8 (105)	0.5 (71)	1.3 (176)
Total	17.2 (2173)	0.2 (28)	7.9 (997)	9.1 (1145)	17.2 (2171)	17.3 (2268)	7.4 (971)	24.7 (3239)	0.2 (31)	14.0 (1844)	10.3 (1358)	24.6 (3234)

## Dry Period

	Pre-Development <sup>2</sup>					Post-Development with PDFs <sup>3</sup>						
	INFLOW	OUTFLOW				INFLOW			OUTFLOW			
	Precipitation	Runoff to Verdugo Cyn	GW Outflow	ET	Total	Precipitation	Irrigation	Total	Runoff to Verdugo Cyn	GW Outflow	ET	Total
OCT	0.3 (43)	0.0 (0)	0.2 (22)	0.4 (45)	0.5 (67)	0.3 (45)	0.5 (65)	0.8 (110)	0.0 (0)	0.6 (84)	0.5 (71)	1.2 (155)
NOV	1.9 (240)	0.0 (0)	0.2 (20)	0.6 (73)	0.7 (93)	1.9 (250)	0.2 (28)	2.1 (278)	0.0 (0)	0.7 (89)	0.6 (81)	1.3 (170)
DEC	2.5 (311)	0.0 (0)	0.3 (35)	0.7 (83)	0.9 (118)	2.5 (325)	0.2 (20)	2.6 (345)	0.0 (0)	0.9 (116)	0.6 (83)	1.5 (199)
JAN	2.9 (368)	0.0 (0)	0.5 (61)	0.7 (91)	1.2 (151)	2.9 (384)	0.1 (17)	3.1 (401)	0.0 (1)	1.1 (142)	0.7 (88)	1.8 (232)
FEB	2.5 (320)	0.0 (5)	0.8 (97)	0.9 (116)	1.7 (217)	2.5 (334)	0.1 (13)	2.6 (346)	0.0 (5)	1.2 (163)	0.8 (112)	2.1 (280)
MAR	2.0 (253)	0.0 (0)	1.0 (126)	1.4 (174)	2.4 (300)	2.0 (263)	0.4 (52)	2.4 (315)	0.0 (0)	1.4 (184)	1.3 (167)	2.7 (351)
APR	1.3 (160)	0.0 (1)	0.8 (97)	1.7 (219)	2.5 (316)	1.3 (167)	0.7 (97)	2.0 (263)	0.0 (1)	1.1 (150)	1.6 (210)	2.8 (361)
MAY	0.4 (50)	0.0 (0)	0.5 (64)	1.7 (218)	2.2 (282)	0.4 (53)	1.0 (125)	1.4 (178)	0.0 (0)	0.9 (122)	1.6 (216)	2.6 (338)
JUN	0.1 (13)	0.0 (0)	0.4 (45)	0.8 (101)	1.2 (146)	0.1 (14)	1.1 (150)	1.2 (164)	0.0 (0)	0.8 (110)	1.0 (138)	1.9 (248)
JUL	0.0 (5)	0.0 (0)	0.3 (36)	0.1 (11)	0.4 (47)	0.0 (6)	1.2 (155)	1.2 (160)	0.0 (0)	0.9 (113)	0.6 (73)	1.4 (186)
AUG	0.1 (17)	0.0 (0)	0.2 (29)	0.1 (13)	0.3 (42)	0.1 (17)	1.1 (144)	1.2 (161)	0.0 (0)	0.8 (111)	0.5 (70)	1.4 (181)
SEP	0.3 (43)	0.0 (0)	0.2 (23)	0.2 (31)	0.4 (54)	0.3 (45)	0.8 (105)	1.1 (150)	0.0 (0)	0.8 (100)	0.5 (72)	1.3 (171)
Total	14.4 (1822)	0.0 (6)	5.2 (654)	9.3 (1175)	14.5 (1834)	14.5 (1901)	7.4 (970)	21.9 (2871)	0.1 (7)	11.3 (1485)	10.5 (1380)	21.9 (2873)

## Wet Period

	Pre-Development <sup>2</sup>					Post-Development with PDFs <sup>3</sup>						
	INFLOW	OUTFLOW				INFLOW			OUTFLOW			
	Precipitation	Runoff to Verdugo Cyn	GW Outflow	ET	Total	Precipitation	Irrigation	Total	Runoff to Verdugo Cyn	GW Outflow	ET	Total
OCT	0.3 (43)	0.0 (0)	0.3 (34)	0.2 (31)	0.5 (65)	0.3 (45)	0.5 (66)	0.8 (110)	0.0 (0)	0.7 (94)	0.5 (60)	1.2 (154)
NOV	1.5 (184)	0.0 (0)	0.2 (28)	0.5 (61)	0.7 (89)	1.5 (193)	0.2 (28)	1.7 (221)	0.0 (0)	0.7 (88)	0.5 (72)	1.2 (160)
DEC	2.0 (255)	0.0 (0)	0.3 (43)	0.6 (75)	0.9 (118)	2.0 (267)	0.2 (21)	2.2 (287)	0.0 (0)	0.9 (115)	0.6 (77)	1.5 (192)
JAN	6.0 (759)	0.1 (13)	1.4 (174)	0.7 (89)	2.2 (275)	6.0 (793)	0.1 (17)	6.2 (810)	0.1 (16)	2.1 (277)	0.7 (88)	2.9 (381)
FEB	5.9 (743)	0.4 (47)	2.4 (306)	0.9 (113)	3.7 (466)	5.9 (776)	0.1 (13)	6.0 (789)	0.4 (47)	3.0 (393)	0.8 (111)	4.2 (550)
MAR	5.1 (645)	0.1 (15)	3.4 (432)	1.3 (167)	4.9 (614)	5.1 (673)	0.4 (50)	5.5 (723)	0.1 (15)	4.1 (532)	1.2 (161)	5.4 (709)
APR	1.1 (141)	0.0 (1)	2.1 (265)	1.7 (220)	3.9 (486)	1.1 (148)	0.7 (98)	1.9 (246)	0.0 (1)	2.5 (325)	1.6 (210)	4.1 (536)
MAY	0.4 (52)	0.0 (0)	1.3 (162)	1.6 (203)	2.9 (365)	0.4 (54)	1.0 (127)	1.4 (181)	0.0 (1)	1.6 (216)	1.6 (205)	3.2 (422)
JUN	0.2 (29)	0.0 (0)	0.8 (103)	0.7 (82)	1.5 (185)	0.2 (30)	1.1 (151)	1.4 (181)	0.0 (0)	1.3 (165)	0.9 (123)	2.2 (288)
JUL	0.0 (2)	0.0 (0)	0.6 (77)	0.0 (3)	0.6 (80)	0.0 (2)	1.2 (155)	1.2 (156)	0.0 (0)	1.1 (149)	0.5 (67)	1.6 (216)
AUG	0.1 (11)	0.0 (0)	0.5 (58)	0.1 (11)	0.5 (69)	0.1 (11)	1.1 (144)	1.2 (156)	0.0 (0)	1.0 (135)	0.5 (68)	1.5 (203)
SEP	0.4 (50)	0.0 (0)	0.4 (45)	0.2 (28)	0.6 (72)	0.4 (53)	0.8 (104)	1.2 (157)	0.0 (0)	0.9 (116)	0.5 (69)	1.4 (185)
Total	23.1 (2916)	0.6 (77)	13.7 (1725)	8.6 (1083)	22.9 (2885)	23.2 (3045)	7.4 (973)	30.6 (4019)	0.6 (81)	19.8 (2606)	10.0 (1312)	30.4 (3998)

### Notes:

- (1) This includes catchments of the Verdugo Sub-basin that are entirely in the Rancho Mission Viejo Boundary. Due to the grading plans of PA4, the total tributary area increases from pre to post development conditions.
- (2) The pre-development catchments include Catchments 120, 121, 122, 123, 124, and 125.
- (3) The post-development catchments include Catchments 120, 121a, 121b, 121c, 122, 123, 124, 125, PA4-4, and PA4-5.

**Appendix E:**  
**IMPACTS ON GROUNDWATER QUALITY**

## IMPACTS ON GROUNDWATER

The impacts of the proposed development on groundwater quality will depend on a number of factors including the local soils and geology, groundwater levels, runoff volume and quality from the proposed development, and the nature and effectiveness of the proposed Water Quality Management Plan, which includes, where appropriate, the utilization of BMPs that rely in part on infiltration.

Groundwater quality is particularly important because groundwater in the San Juan Groundwater Basin is utilized for municipal supply, and local groundwater is utilized for nursery, agricultural, and ranching purposes. Pumping from the alluvium of lower San Juan Creek by the San Juan Basin Authority and other large pumpers is projected to increase from about 7,800 acre-ft/year to about 9,000 acre-ft/yr; the increase in supply is anticipated as a result of the proposed project (Hecht, 2001).

The concern for potential impacts to groundwater quality is emphasized in the San Diego RWQCB MS4 Orange County Permit (Order No. R9-2002-0001) under the Standard Urban Storm Water Mitigation Plans (SUSMPs) Section F.1.b(2)(h) titled “Infiltration and Groundwater Protection”, and in the Orange County DAMP Section 7.II-3.3.4 Treatment Control BMPs under the sub-section titled “Restrictions on Use of Infiltration BMPs”. These restrictions address such requirements as need for pretreatment, soil characteristics that are suitable for infiltration, minimum depth to seasonal high groundwater (10 feet), avoidance of infiltration from areas with high pollutant potential (e.g., industrial areas), and avoiding infiltration of dry weather flows.

The WQMP has been designed to meet these requirements and is based on the following multi-tiered approach: (1) site design and source control BMPs will be implemented to prevent the discharge of pollutants to the maximum extent practicable, (2) the proposed combined control system will incorporate infiltration only where there is at least a 10 foot separation to groundwater, and (3) where infiltration is proposed, the water will be pretreated in a water quality treatment basin sized to meet MS4 Permit requirements.

The pretreatment will occur in the flow control/water quality basins upstream of the infiltration basins. In the low flow portions of these basins, vegetation would be allowed to grow and decay, which will provide an adsorptive organic layer on the bottom of these basins that will assist in pollutant uptake. The upstream flow control/water quality basins are designed to achieve a residence time of approximately 7-10 days for dry weather flows, and will have a 48 hour drain time for wet weather flows. These residence times have been chosen to provide good pretreatment prior to discharging into the infiltration basins. As discussed below, pretreatment also will be provided in the infiltration basins themselves as the soils will provide filtration and sites for adsorption.



Pollutants of concern are those that tend to be more in the dissolved form, have high mobility (low sorption potential), and are prevalent in stormwater runoff or dry weather nuisance flows (Pitt et. al., 1994). Sorption potential is important because data indicate that chemicals with high sorption potential tend to accumulate in the top few centimeters of soil in retention basins studied in Fresno, California (Nightingale, 1987). With pretreatment that includes sedimentation, and assuming a worst case of sandy soils, Pitt et. al. identify the following pollutants as having at least a low/moderate to high potential for affecting groundwater quality: nitrates (low/moderate), fluoranthene (moderate), pyrene (moderate), *Shigella* and *Pseudomonas aeruginosa* (low/moderate), protozoa (low/moderate), chromium (low/moderate), and chloride (high). *Shigella* and *Pseudomonas aeruginosa* are pathogenic bacteria, and fluoranthene and pyrene are polycyclic aromatic hydrocarbons (PAHs).

The only pollutant of concern for which there is a groundwater quality objective is nitrate. The water quality objective for nitrate-nitrogen is 10 mg/L; however, this level is much higher than observed concentrations of nitrate-nitrogen in urban runoff. For example, the range of observed nitrate-nitrogen concentrations from urban land uses in LA County are about 0.3 to 1.4 mg/L. Projected effluent concentrations from the FD/WQ basin would be about 0.3 mg/L.

Dissolved solids is also a drinking water issue, however urban runoff TDS concentrations typically range between about 100-200 mg/l which are low compared to anticipated groundwater TDS concentrations. Wildermuth measured TDS in local streams that ranged between 100-500 mg/L with the higher values associated with dry weather flows fed by shallow groundwater.

Impacts from treated stormwater runoff or dry weather nuisance flows on bacteria or hydrocarbon concentrations in groundwater are generally considered limited where pretreatment and effective source controls are implemented, especially for residential development. Andrew Potts (Cahill Associates), in email correspondence, cites a study conducted by Dierkes and Geiger (1999) that showed that PAHs in highway runoff were effectively removed in the upper four inches of soil.

In summary, the combination of source controls, pretreatment in upstream water quality treatment basins, and pretreatment in the upper soils profile of the infiltration basins will substantially limit the release of pollutants to the groundwater. On this basis, the potential for adversely affecting groundwater quality for these pollutants of concern is considered less than significant.

## REFERENCES

- Dierkes and Geiger, 1999. Pollution Retention Capabilities of Roadside Soils, Water Science and Technology. Vol. 39, No. 2, pp. 201-208.
- Hecht, B. 2001. Groundwater Sustaining Landscape Scale Wetland Functions, San Juan and San Mateo Watersheds, Southern Orange County, California. Appendix C to Baseline Report.

Nightingale, H.I., 1987. Accumulation of As, Ni, Cu, and Pb in Retention and Recharge Basins Soils from Urban Runoff, American Water Resources Association, Water Resources Bulletin, Vol. 23, No.4, August.

Pitt, R., S. Clark, and K. Parmer. 1994. Protection of Groundwater from Intentional and Nonintentional Stormwater Infiltration, U.S. Environmental Protection Agency, EPA/600/SR-94/051, 187 pgs. May.



---

---

**TECHNICAL MEMORANDUM**

---

---

**TO:** BRUCE PHILLIPS (PACE)  
**FROM:** PETER MANGARELLA (GEOSYNTEC CONSULTANTS)  
**SUBJECT:** IMPACTS ON GROUNDWATER QUALITY  
**DATE:** MAY 23, 2004  
**CC:** LAURA COLEY-EISENBERG (RMV)

---

The impacts of the proposed development on groundwater quality will depend on a number of factors including the local soils and geology, groundwater levels, runoff volume and quality from the proposed development, and the nature and effectiveness of the proposed Water Quality Management Plan, which includes, where appropriate, the utilization of BMPs that rely in part on infiltration.

Groundwater quality is particularly important because groundwater in the San Juan Groundwater Basin is utilized for municipal supply, and local groundwater is utilized for nursery, agricultural, and ranching purposes. Pumping from the alluvium of lower San Juan Creek by the San Juan Basin Authority and other large pumpers is projected to increase from about 7,800 acre-ft/year to about 9,000 acre-ft/yr; the increase in supply is anticipated as a result of the proposed project (Hecht, 2001).

The concern for potential impacts to groundwater quality is emphasized in the San Diego RWQCB MS4 Orange County Permit (Order No. R9-2002-0001) under the Standard Urban Storm Water Mitigation Plans (SUSMPs) Section F.1.b(2)(h) titled "Infiltration and Groundwater Protection", and in the Orange County DAMP Section 7.II-3.3.4 Treatment Control BMPs under the sub-section titled "Restrictions on Use of Infiltration BMPs". These restrictions address such requirements as need for pretreatment, soil characteristics that are suitable for infiltration, minimum depth to seasonal high groundwater (10 feet), avoidance of infiltration from areas with high pollutant potential (e.g., industrial areas), and avoiding infiltration of dry weather flows.

The WQMP has been designed to meet these requirements and is based on the following multi-tiered approach: (1) site design and source control BMPs will be implemented to prevent the discharge of pollutants to the maximum extent practicable, (2) the proposed combined control system will incorporate infiltration only where there is at least a 10 foot separation to groundwater, and (3) where infiltration is proposed, the water will be pretreated in a water quality treatment basin sized to meet MS4 Permit requirements.

The pretreatment will occur in the flow control/water quality basins upstream of the infiltration basins. In the low flow portions of these basins, vegetation would be allowed to grow and decay, which will provide an adsorptive organic layer on the bottom of these basins that will assist in pollutant uptake. The upstream flow control/water quality basins are designed to achieve a residence time of approximately 7-10 days for dry weather flows, and will have a 48 hour drain time for wet weather flows. These residence times have been chosen to provide good pretreatment prior to discharging into the infiltration basins. As discussed below, pretreatment also will be provided in the infiltration basins themselves as the soils will provide filtration and sites for adsorption.

Pollutants of concern are those that tend to be more in the dissolved form, have high mobility (low sorption potential), and are prevalent in stormwater runoff or dry weather nuisance flows (Pitt et. al.,

1994). Sorption potential is important because data indicate that chemicals with high sorption potential tend to accumulate in the top few centimeters of soil in retention basins studied in Fresno, California (Nightingale, 1987). With pretreatment that includes sedimentation, and assuming a worst case of sandy soils, Pitt et. al. identify the following pollutants as having at least a low/moderate to high potential for affecting groundwater quality: nitrates (low/moderate), fluoranthene (moderate), pyrene (moderate), Shigella and Psuedomonas aeruginosa (low/moderate), protozoa (low/moderate), chromium (low/moderate), and chloride (high). Shigella and Psuedomonas aeruginosa are pathogenic bacteria, and fluoranthene and pyrene are polycyclic aromatic hydrocarbons (PAHs).

The only pollutant of concern for which there is a groundwater quality objective is nitrate. The water quality objective for nitrate-nitrogen is 10 mg/L; however, this level is much higher than observed concentrations of nitrate-nitrogen in urban runoff. For example, the range of observed nitrate-nitrogen concentrations from urban land uses in LA County are about 0.3 to 1.4 mg/L. Projected effluent concentrations from the FD/WQ basin would be about 0.3 mg/L.

Dissolved solids is also a drinking water issue, however urban runoff TDS concentrations typically range between about 100-200 mg/l which are low compared to anticipated groundwater TDS concentrations. Wildermuth measured TDS in local streams that ranged between 100-500 mg/L with the higher values associated with dry weather flows fed by shallow groundwater.

Impacts from treated stormwater runoff or dry weather nuisance flows on bacteria or hydrocarbon concentrations in groundwater are generally considered limited where pretreatment and effective source controls are implemented, especially for residential development. Andrew Potts (Cahill Associates), in email correspondence, cites a study conducted by Dierkes and Geiger (1999) that showed that PAHs in highway runoff were effectively removed in the upper four inches of soil.

In summary, the combination of source controls, pretreatment in upstream water quality treatment basins, and pretreatment in the upper soils profile of the infiltration basins will substantially limit the release of pollutants to the groundwater. On this basis, the potential for adversely affecting groundwater quality for these pollutants of concern is considered less than significant.

## REFERENCES

- Dierkes and Geiger, 1999. Pollution Retention Capabilities of Roadside Soils, Water Science and Technology. Vol. 39, No. 2, pp. 201-208.
- Hecht, B. 2001. Groundwater Sustaining Landscape Scale Wetland Functions, San Juan and San Mateo Watersheds, Southern Orange County, California. Appendix C to Baseline Report.
- Nightingale, H.I., 1987. Accumulation of As, Ni, Cu, and Pb in Retention and Recharge Basins Soils from Urban Runoff, American Water Resources Association, Water Resources Bulletin, Vol. 23, No.4, August.
- Pitt, R., S. Clark, and K. Parmer. 1994. Protection of Groundwater from Intentional and Nonintentional Stormwater Infiltration, U.S. Environmental Protection Agency, EPA/600/SR-94/051, 187 pgs. May.